

# PN 90402 - SBE 45 Power, Navigation, and Remote Temperature Interface Box

*For use with SBE 45 MicroTSG*



## **User's Manual**

Sea-Bird Electronics, Inc.  
1808 136<sup>th</sup> Place NE  
Bellevue, Washington 98005 USA  
Telephone: 425-643-9866  
Fax: 425-643-9954  
E-mail: seabird@seabird.com  
Website: www.seabird.com

**Manual Version #004, 02/27/06  
Firmware Version 1.4 and later**

# Limited Liability Statement

Extreme care should be exercised when using or servicing this equipment. It should be used or serviced only by personnel with knowledge of and training in the use and maintenance of oceanographic electronic equipment.

SEA-BIRD ELECTRONICS, INC. disclaims all product liability risks arising from the use or servicing of this system. SEA-BIRD ELECTRONICS, INC. has no way of controlling the use of this equipment or of choosing the personnel to operate it, and therefore cannot take steps to comply with laws pertaining to product liability, including laws which impose a duty to warn the user of any dangers involved in operating this equipment. Therefore, acceptance of this system by the customer shall be conclusively deemed to include a covenant by the customer to defend, indemnify, and hold SEA-BIRD ELECTRONICS, INC. harmless from all product liability claims arising from the use or servicing of this system.

# Table of Contents

<b>Section 1: Introduction</b> .....	<b>4</b>
About this Manual .....	4
How to Contact Sea-Bird .....	4
Unpacking Interface Box .....	5
<b>Section 2: Interface Box Description</b> .....	<b>6</b>
System Description .....	6
Specifications .....	6
Connections, Switches, and LEDs .....	7
System Communications .....	8
Data Output Format .....	8
<b>Section 3: Setting Up System</b> .....	<b>10</b>
Installing Software .....	10
Communications Test and Setup .....	11
Commands .....	14
Setting Up Instruments .....	17
SBE 45 .....	17
SBE 38 .....	17
NMEA Navigation Device .....	18
Setting Up SBE 45 Configuration (.con) File in SEASAVE .....	19
<b>Section 4: Operating System</b> .....	<b>20</b>
Acquiring Real-Time Data with SEASAVE .....	20
Processing Data with SBE Data Processing .....	21
<b>Section 5: Troubleshooting</b> .....	<b>22</b>
Problem 1: Unable to Communicate with Interface Box .....	22
Problem 2: Unable to Communicate with SBE 45 through Interface Box .....	22
Problem 3: Unable to Communicate with SBE 38 through Interface Box .....	23
Problem 4: Unable to Communicate with NMEA Navigation Device through Interface Box .....	23
Problem 5: Nonsense or Unreasonable Data .....	23
Problem 6: Changing SBE 45 and/or SBE 38 Baud Rate without Cables for Direct Connection .....	24
<b>Glossary</b> .....	<b>25</b>
<b>Appendix I: NMEA Data</b> .....	<b>26</b>
NMEA Raw Message Formats .....	26
Troubleshooting NMEA .....	27
Problem 1: Yellow <i>NMEA</i> LED Not Flashing .....	27
Problem 2: Yellow <i>NMEA</i> LED Flashing, but Lat/Lon Data Not Displaying .....	27
NMEA Simulation Program .....	28
<b>Appendix II: Replacement Parts</b> .....	<b>30</b>
<b>Index</b> .....	<b>31</b>

# Section 1: Introduction

This section includes contact information and photos of a standard PN 90402 – SBE 45 Power, Navigation, and Remote Temperature Interface Box shipment.

---

## About this Manual

This manual is to be used with the PN 90402 – SBE 45 Power, Navigation, and Remote Temperature Interface Box for the SBE 45 MicroTSG.

It is organized to guide the user from installation through operation. We have included specifications, setup and operation descriptions, and helpful notes throughout the manual.

Sea-Bird welcomes suggestions for new features and enhancements of our products and/or documentation. Please e-mail any comments or suggestions to seabird@seabird.com.

---

## How to Contact Sea-Bird

Sea-Bird Electronics, Inc.  
1808 136<sup>th</sup> Place Northeast  
Bellevue, Washington 98005 USA

Telephone: 425-643-9866  
Fax: 425-643-9954  
E-mail: seabird@seabird.com  
Website: <http://www.seabird.com>

Business hours:  
Monday-Friday, 0800 to 1700 Pacific Standard Time  
(1600 to 0100 Universal Time)  
Except from April to October, when we are on *summer time*  
(1500 to 0000 Universal Time)

## Unpacking Interface Box

Shown below is a typical PN 90402 – SBE 45 Power, Navigation, and Remote Temperature Interface Box shipment.



Interface Box



Cable -  
SBE 45 to Interface Box



AC power cable



DC power  
connector



I/O cable (Interface Box  
to computer)



25-pin to 9-pin adapter  
(for use with computer with  
DB-25 connector)



Connectors for *SBE 45*,  
*SBE 38*, and *NMEA*  
(3 connectors/Interface Box)



Navigation Interface test cable  
(Interface Box to NMEA navigation  
device simulation computer)



(optional) Cable -  
SBE 38 to Interface Box

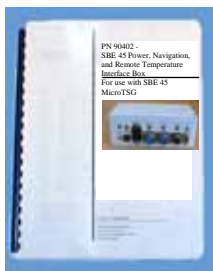

Interface Box  
Manual



Software, and Electronic Copies of  
Software Manuals and User Manual

# Section 2: Interface Box Description

This section describes the functions and features of the Interface Box, system communications, and output data format.

## System Description

The PN 90402 – SBE 45 Power, Navigation, and Remote Temperature Interface Box provides power and an opto-isolated RS-232C interface for the SBE 45 MicroTSG Thermosalinograph. Additionally, the Interface Box provides:

- An opto-isolated NMEA receiver for an optional NMEA navigation device (not supplied by Sea-Bird)
- Power and an RS-232C interface for an optional SBE 38 remote temperature sensor

Baud rates between the Interface Box and SBE 45, SBE 38, NMEA navigation device, and computer are user-programmable.

The Interface Box merges position data and SBE 38 remote temperature data with SBE 45 data. The NMEA Interface decodes messages that are output from navigation devices supporting NMEA 0183 protocol, outputting data in GGA, GLL, RMA, RMC, or TRF format. Decoded Latitude, Longitude, date, and time and SBE 38 temperature data are appended to the SBE 45 data stream in the Interface Box. The data, in ASCII engineering units, is passed to the computer for storage and/or display.

### Notes:

- Help files provide detailed information on software use.
- NMEATest, a NMEA navigation device simulation program, is part of the SBE Data Processing installation.
- Separate software manuals on CD-ROM contain detailed information on the setup and use of SEASAVE and SBE Data Processing.
- Sea-Bird also supplies a DOS software package, SEASOFT-DOS. However, the DOS software is not compatible with the Interface Box and SBE 45.

The Interface Box can be AC- or DC-powered:

- **AC power** - universal 85-265 VAC input with frequency of 47-63 Hz
- **DC power** - 10-28 VDC input.

The Interface Box is supplied with a powerful Win 95/98/NT/2000/XP software package, SEASOFT-Win32, which includes:

- **SEATERM** – terminal program for easy setup.
- **SEASAVE** – program for acquiring, converting, and displaying real-time or archived raw data.
- **SBE Data Processing** – program for calculation and plotting of conductivity, temperature, pressure, auxiliary sensor data, and derived variables such as salinity and sound velocity.

## Specifications

<b>Power Requirements</b>	AC: 85-265 VAC 47-63 Hz, <b>or</b> DC: 10-28 VDC DC operating current - 27 ma for Interface Box alone, 65 mA for Interface Box with SBE 45, 80 ma for Interface Box with SBE 45 and 38
<b>Dimensions</b>	200 x 121 x 76 mm (7.875 x 4.75 x 3 inch)
<b>Weight</b>	1.1 kg (2.5 lbs)

## Connections, Switches, and LEDs

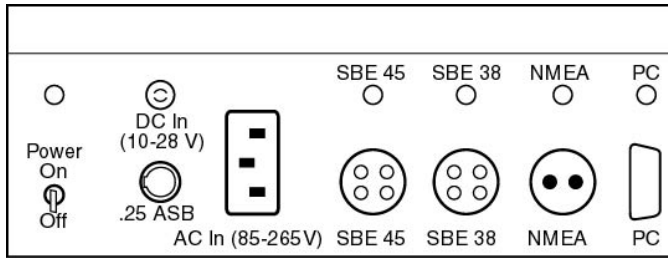

### Connections:

- *AC In* - to standard, 3-prong, grounded, 85-265 VAC power supply, using the supplied UL/IED-approved power cord, **or**  
*DC In* - to 10-28 VDC power supply

- *SBE 45* - to SBE 45 MicroTSG; use supplied 4-pin MS-3106A-14S-2P connector or supplied cable:

Interface Box	Function
Pin A	Common
Pin B	RS-232 data transmit to SBE 45
Pin C	RS-232 data receive from SBE 45
Pin D	Power to SBE 45

- *SBE 38* - to SBE 38 remote temperature sensor; use supplied 4-pin MS-3106A-14S-2P connector or optional cable:

Interface Box	Function
Pin A	Common
Pin B	RS-232 data transmit to SBE 38
Pin C	RS-232 data receive from SBE 38
Pin D	Power to SBE 38

- *NMEA* - to NMEA navigation device; use supplied 2-pin MS-3106A12S-3S connector or supplied test cable:

Interface Box	Function
Pin A	NMEA A (signal)
Pin B	NMEA B (signal return)

- *PC* - to computer with supplied DB-9P/DB-9S cable.

Interface Box	Function
Pin 2	RS-232 data receive from computer
Pin 3	RS-232 data transmit to computer
Pin 5	Ground

### Power Switch and Red LED:

Switch turns power to Interface Box on/off. Red LED turns on to indicate power is on.

### LEDs:

Indicate if Interface Box is communicating with other parts of system:

LED:	Flashes when carriage return (decimal 13) received from:
Yellow <i>SBE 45</i>	SBE 45
Yellow <i>SBE 38</i>	SBE 38
Yellow <i>NMEA</i>	NMEA navigation device
Green <i>PC</i>	Computer

## System Communications

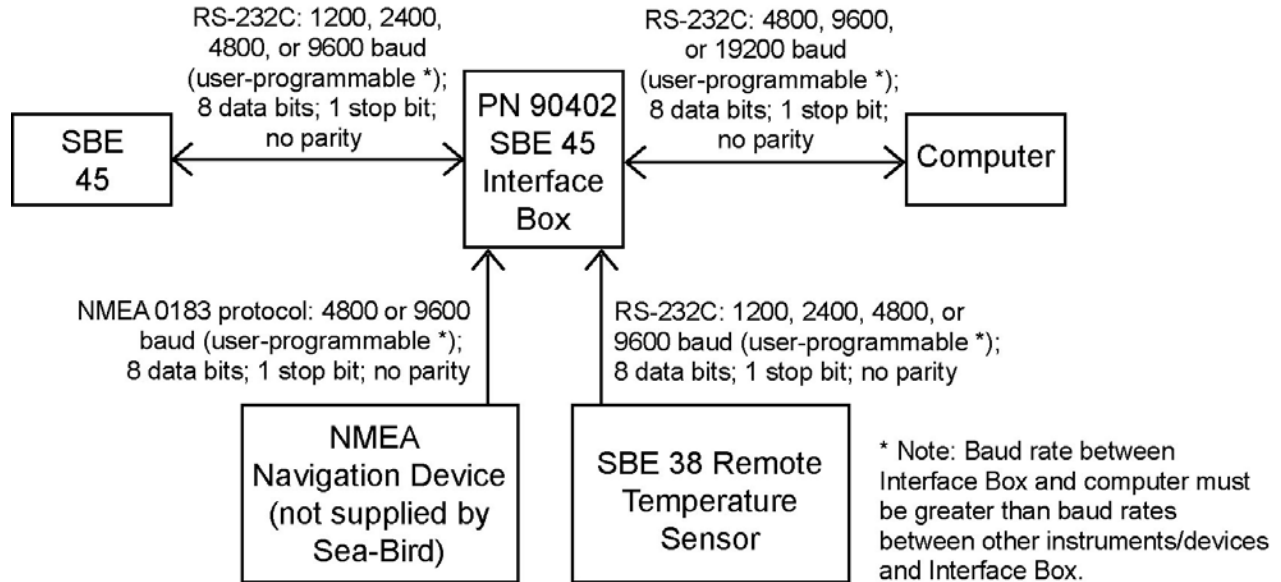

## Data Output Format

**The time between each output scan is governed by the SBE 45's setup.** The Interface Box outputs the most recent data from the SBE 38 and/or NMEA navigation device with each scan of SBE 45 data.

The Interface Box outputs data in the following format and order:



**Notes:**

- Inclusion of all parameters except for t1 (temperature from SBE 45) is dependent on configuration – if the system does not include the specified instrument or the parameter is not enabled, the corresponding data is not included in the output data stream, shortening the data string.
- Not all NMEA navigation devices transmit time and / or date.

**FORMAT=0 (standard format)**

t1=ttt.tttt, c1=cc.ccccc, s = sss.ssss, sv=vvvv.vvv,  
t2 = ttt.tttt, lat = DD MM.MMMM W, lon = DDD MM.MMMM W,  
hms = HHMMSS, dmy = DDMMYY

*where*

- t1 = temperature from SBE 45 (°C, ITS-90).
- c1 = conductivity from SBE 45 (S/m);  
output if **OUTPUTCOND=Y** in SBE 45.
- s = salinity (psu) calculated from t1 and c1 by SBE 45;  
output if **OUTPUTSAL=Y** in SBE 45.
- sv = sound velocity (m/sec); output if **OUTPUTSV=Y** in SBE 45.
  - If the Interface Box is acquiring data from an **SBE 38** remote temperature sensor and if the SBE 45 is set to **OUTPUTCOND=Y** or **OUTPUTSAL=Y**: the Interface Box *recalculates* sound velocity based on s (or t1 and c1) from the SBE 45 and temperature t2 from the SBE 38. This provides the most accurate sound velocity results, because sound velocity is a function of salinity and temperature, and the SBE 38 typically provides more accurate sea surface temperature than the thermosalinograph, since it is closer to the seawater intake.
  - Otherwise: the Interface Box outputs sound velocity calculated from t1 and c1 by the SBE 45.
- t2 = temperature from SBE 38 (°C, ITS-90 if **FORMAT=C** in SBE 38; number of digits after decimal point is set with **DIGITS=** in SBE 38).
- lat = latitude from NMEA navigation device.  
DD = degrees.  
MM.MMMM = minutes and fractions of minutes; number of digits after decimal point is number of digits in received NMEA string.  
W = N (north) or S (south).
- lon = longitude from NMEA navigation device.  
DDD = degrees.  
MM.MMMM = minutes and fractions of minutes; number of digits after decimal point is number of digits in received NMEA string.  
W = E (east) or W (west).
- hms = time from NMEA navigation device (hour, minute, second).
- dmy = date from NMEA navigation device (day, month, year).

All data is separated with a comma and a space. Each scan ends with a carriage return <CR> and line feed <LF>. Leading zeros are suppressed, except for one zero to the left of the decimal point.

**FORMAT=1 (custom format for interfacing with a Kongsberg EM 300 Multibeam Echo Sounder)**

tt.ttt vvvv.v

*where*

- tt.ttt = temperature from SBE 38 remote temperature sensor (°C, ITS-90).
- vvvv.v = sound velocity (m/sec) calculated in Interface Box from:
  - salinity based on conductivity and temperature measured by SBE 45, and
  - temperature measured by SBE 38 remote temperature sensor

Temperature and sound velocity data is separated with a space. Each scan ends with a carriage return <CR> and line feed <LF>. Leading zeros are suppressed, except for one zero to the left of the decimal point.

**Note:**

When using **FORMAT=1**:

- Set up the SBE 45 with:
  - **OUTPUTSV=Y**, and
  - **OUTPUTCOND=Y** and/or **OUTPUTSAL=Y**
 and connect an SBE 38 to the Interface Box.
- The Interface Box will not output any parameters other than what is shown at right, regardless of settings in the SBE 45 or connection of the Interface Box to a NMEA navigation device.
- **FORMAT=1** is not compatible with SEASAVE real-time data acquisition software or SBE Data Processing post-processing software.

# Section 3: Setting Up System

This section covers:

- Installing Sea-Bird software
- Communications testing and setup
- System commands
- Setting up the SBE 45 configuration (.con) file

---

## Installing Software

Recommended minimum system requirements:  
Pentium 90 CPU, 64 Mbyte RAM, Windows 98 or later.

If not already installed, install Sea-Bird software on your computer using the supplied software CD.

1. With the CD in your CD drive, double click on **Seasoft-Win32.exe**.
2. Follow the dialog box directions to install the software.

**Notes:**

- Help files provide detailed information on SEATERM, SEASAVE, and SBE Data Processing.
- NMEATest, a NMEA navigation device simulation program, is part of the SBE Data Processing installation.
- Separate software manuals on CD-ROM contain detailed information on the setup and use of SEASAVE and SBE Data Processing.

The installation program allows you to install the desired components. Install all the components, or just install SEATERM (terminal program), SEASAVE (real-time data acquisition), and SBE Data Processing (data processing). The default location for the software is c:/Program Files/Sea-Bird. Within that folder is a sub-directory for each program.

## Communications Test and Setup

### Notes:

- See SEATERM's Help files.
- The Interface Box is not available in the list of instrument types.  
**Select SBE 45 as the instrument type.**

1. With power to the Interface Box **off**, double click on SeaTerm.exe. If this is the first time SEATERM is used, the setup dialog box may appear:



Select the instrument type (SBE 45 TSG) and the computer COM port for communication with the Interface Box. Click OK.

2. The main screen looks like this:

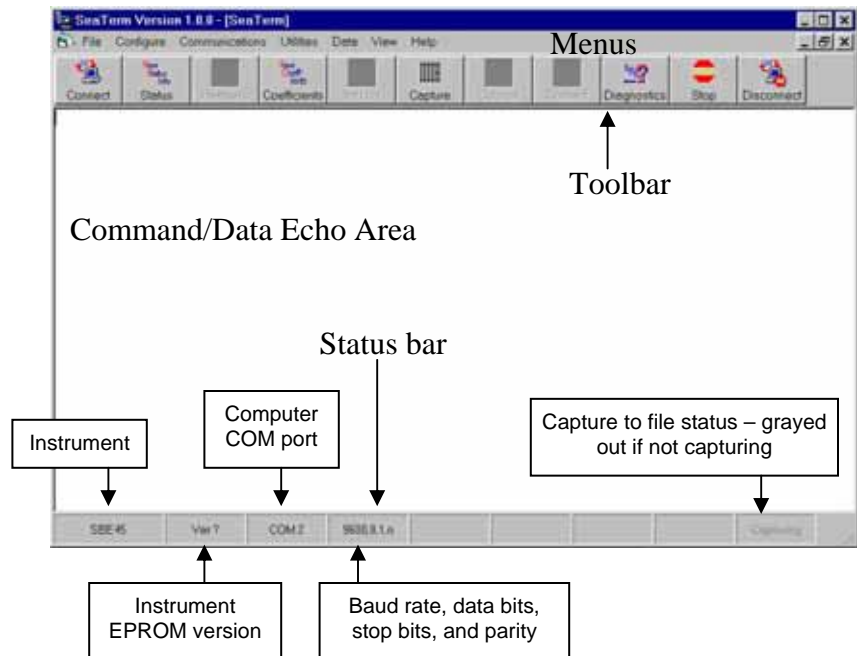

### Note:

There is at least one way, and as many as three ways, to enter a command:

- Manually type a command in Command/Data Echo Area
- Use a menu to automatically generate a command
- Use a Toolbar button to automatically generate a command

### Note:

Once the system is configured and connected (Steps 3 and 4 below), to update the Status bar:

- on the Toolbar, click Status; or
- from the Utilities menu, select Instrument Status.

SEATERM sends the status command, which displays in the Command/Data Echo Area, and updates the Status bar.

- **Menus** – Contains tasks and frequently executed instrument commands.
- **Toolbar** – Contains buttons for frequently executed tasks and instrument commands. All tasks and commands accessed through the Toolbar are also available in the Menus. To display or hide the Toolbar, select View Toolbar in the View menu. Grayed out Toolbar buttons are not applicable.
- **Command/Data Echo Area** – Echoes a command executed using a Menu or Toolbar button, as well as the instrument's response. Additionally, a command can be manually typed in this area, from the available commands for the instrument.
- **Status bar** – Provides status information. To display or hide the Status bar, select View Status bar in the View menu.

Following are the Toolbar keys applicable to the Interface Box:

Toolbar Keys	Description	Equivalent Command*
Connect	Re-establish communications with Interface Box. Computer responds with S> prompt.	(press Enter key)
Status	Display instrument status.	<b>DS</b>
Capture	Capture instrument responses on screen to file. Interface Box has no internal memory; <b>you must capture before sampling begins to save data for future review and processing, or use SEASAVE for data acquisition.</b> File has .cap extension. Press Capture again to turn off capture. Capture status displays in Status bar.	—
Disconnect	Free computer COM port used to communicate with Interface Box. COM port can then be used by another program.	—

\*See *Command Descriptions*.

**Note:**

The Interface Box is not available in the list of instrument types. **Select SBE 45 as the instrument type.**

3. In the Configure menu, select SBE 45 TSG. The dialog box looks like this:

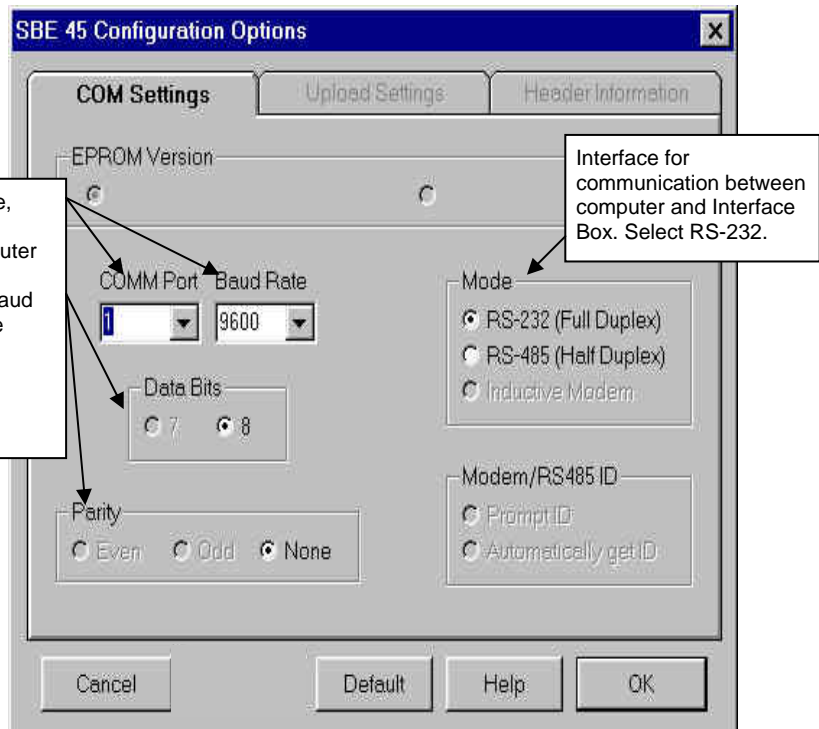

Computer COM port, baud rate, data bits, and parity for communication between computer and Interface Box. Select 4800, 9600, or 19200 baud (set this greater than baud rate you will use to communicate between Interface Box and SBE 45, SBE 38, and NMEA navigation device).

Interface for communication between computer and Interface Box. Select RS-232.

**Notes:**

- SEATERM's baud rate must be the same as the Interface Box baud rate (set with **PCBAUD=**). Baud is factory-set to 9600, but can be changed by the user (see *Commands*).
- When you click OK, SEATERM saves the Configuration Options settings to the SeaTerm.ini file in your Windows directory. SeaTerm.ini contains the last saved settings for each instrument (SBE 37, 45, etc.). When you open SEATERM and select the desired instrument in the Configure menu, the Configuration Options dialog box shows the last saved settings for that instrument.

Make the selections in the Configuration Options dialog box. Click OK to save the settings.

4. Turn on power to the Interface Box. The display looks like this (if the Interface Box is set up to power-up in Normal mode with the **IMODE=NORMAL** command; see *Commands* for details):

```
SBE45 Junction Box V 1.4
mode is normal
```

If the system does not respond as described:

- Click Connect on the Toolbar to attempt to establish communications.
- Verify the SBE 45 was selected in the Configure menu and settings were entered correctly in the Configuration Options dialog box.
- Check cabling between the computer and the Interface Box.
- If the response shows `mode is connect45`, the Interface Box is set up to power-up in SBE 45 mode (**IMODE=CONNECT45**). Type @ to return to Normal mode for communication with the Interface Box.

**Note:**

The Interface Box outputs data at the SBE 45's data output rate. If the SBE 45 is not outputting any data, data from the SBE 38 and/or NMEA navigation device will not appear at all.

5. If the SBE 45 was set to **AUTORUN=Y** and its J1 jumper was set to pins 1 and 2 (begin sampling automatically on power up), data from the Interface Box begins scrolling on the screen. Each time data is received from an instrument (SBE 45, SBE 38, and NMEA navigation device), the corresponding yellow LED on the Interface Box flashes. If data is not received, is incorrect, or is not updating properly for some or all instruments:
  - Verify that the instrument is connected to the Interface Box and that the proper cable is used.
  - Check the baud rate of each instrument (SBE 45, SBE 38, and NMEA navigation device). These baud rates must be less than the baud rate for communication between the Interface Box and the computer. If necessary, connect each instrument directly to the computer and use SEATERM to reset its baud rate. See the appropriate instrument manual for details.
  - Check that the setup of each instrument is compatible with operation with the Interface Box. See *Setting Up Instruments*.
  - If data is not received from a NMEA navigation device, see *Appendix I: NMEA Data* for troubleshooting information.
  
6. If desired, type **STOP** and press the Enter key to stop the scrolling data. Note that you can send commands to the Interface Box and/or attached instruments while it is transmitting data, but it is easier to see what the commands and responses are without the scrolling data.
  
7. Display Interface Box status information by clicking Status on the Toolbar. The display looks like this:
 

```
SBE45 Junction Box V 1.4
SBE 45 baud rate = 4800
SBE 38 baud rate = 4800
NMEA baud rate = 4800
standard output format
```

Note that the baud rates shown must be less than the baud rate for communication between the Interface Box and the computer.
  
8. Verify SBE 45 setup by putting the Interface Box in SBE 45 mode:
  - A. Type **CONNECT45** and press the Enter key. If the SBE 45 is set for **AUTOPOWER=Y** and **SINGLESAMPLE=N**, SBE 45 data will scroll across the screen. Type **STOP** and press the Enter key to stop the scrolling data.
  - B. Send desired setup commands to the SBE 45 (see *Setting Up Instruments* for required setup parameters).
  - C. Type **GO** and press the Enter key to restart SBE 45 sampling. SBE 45 data should begin scrolling on the screen.
  - D. Type @ to return to Normal mode for communication with the Interface Box.
  
9. Verify SBE 38 setup by putting the Interface Box in SBE 38 mode:
  - A. Type **CONNECT38** and press the Enter key. If the SBE 38 is set for **AUTOPOWER=Y**, SBE 38 data will scroll across the screen. Type **STOP** and press the Enter key to stop the scrolling data.
  - B. Send desired setup commands to the SBE 38 (see *Setting Up Instruments* for required setup parameters).
  - C. Type **GO** and press the Enter key to restart SBE 38 sampling. SBE 38 data should begin scrolling on the screen.
  - D. Type @ to return to Normal mode for communication with the Interface Box.
  
10. Type **START** and press the Enter key to restart data transmission through the Interface Box.

**Note:**

You must restart SBE 45 and SBE 38 sampling using **GO** before returning to Normal mode, or these instruments will not transmit their data to the Interface Box.

The system is ready for deployment.

## Commands

This section describes commands and provides sample outputs.

When entering commands:

- Input commands to the Interface Box in upper or lower case letters and register commands by pressing the Enter key.
- The Interface Box sends ? if an invalid command is entered.
- If the system does not return an S> prompt after executing a command, press the Enter key to get the S> prompt.
- The Interface Box can accept commands while transmitting data. Type in any command and press the Enter key; the S> is not required.

---

### Status Command

---

#### DS

Display firmware version and baud rate settings. Equivalent to Status button on Toolbar.

List includes, where applicable, command used to modify parameter.

- firmware version
- SBE 45 baud rate [**45BAUD=**]
- SBE 38 baud rate [**38BAUD=**]
- NMEA baud rate [**NMEABAUD=**]
- output format [**FORMAT=**] – standard output format or output format 1

*Example:* (user input shown in bold)

```
S>DS
SBE45 Junction Box V 1.4
SBE 45 baud rate = 4800           [45BAUD=]
SBE 38 baud rate = 4800           [38BAUD=]
NMEA baud rate = 4800             [NMEABAUD=]
standard output format           [FORMAT=]
```

---

### Baud Rate Commands

---

#### PCBAUD=x

x= baud rate for communication between Interface Box and computer (4800, 9600, or 19200). Default 9600.

#### 45BAUD=x

x= baud rate for communication between Interface Box and SBE 45 (1200, 2400, 4800, or 9600). Default 4800. Must match baud set in SBE 45 with **BAUD=**.

#### 38BAUD=x

x= baud rate for communication between Interface Box and optional SBE 38 (1200, 2400, 4800, or 9600). Default 4800. Must match baud set in SBE 38 with **BAUD=**.

#### NMEABAUD=x

x= baud rate for communication between Interface Box and optional NMEA navigation device (4800 or 9600). Default 4800. Must match baud of NMEA navigation device.

**Note:**

Baud rate for communication between Interface Box and computer must be greater than baud between Interface Box and SBE 45, SBE 38, and NMEA navigation device.

---

**Mode Commands**

---

**Notes:**

- **IMODE=CONNECT45** is not compatible with SEASAVE real-time data acquisition software.
- Type @ or press the Esc key to exit SBE 45, SBE 38, or NMEA mode and return to Normal mode for communicating with the Interface Box.

**IMODE=x**

**x=NORMAL:** On power-up, Interface Box is in Normal mode for communicating with Interface Box.

**x=CONNECT45:** On power-up, Interface Box is in SBE 45 mode, for communicating with SBE 45 through Interface Box. Equivalent to powering up in Normal mode, and then immediately sending **CONNECT45**. *When you send **IMODE=CONNECT45**, Interface Box is also immediately placed in SBE 45 mode.*

*Example: (user input shown in bold)*

With the Interface Box in Normal mode, turn power on. Interface Box responds as follows:

```
S>SBE 45 Junction Box V 1.4
mode is normal
S>IMODE=CONNECT45      (send command to change start-up mode; also switches to SBE 45 mode now)
Connected to SBE 45, press @ or Esc to return to normal mode
S>DS                  (transmitted to SBE 45, so status response is from SBE 45)
SBE45 V 1.1 SERIAL NO. 0059
. . . . (see SBE 45 manual for remainder of SBE 45 status response)
S>
@          (put Interface Box back in normal mode)
mode switched back to normal
S>DS                  (transmitted to Interface Box, so status response is from Box)
SBE45 Junction Box V 1.4
. . . . (see above for remainder of Interface Box status response)
```

Turn power off and then on again. Interface Box starts up in SBE 45 mode:

```
S>SBE 45 Junction Box V 1.4
Mode is connect 45
SBE45 V 1.1
S>          (send commands to SBE 45 as desired)
```

**CONNECT45**

Put Interface Box in SBE 45 mode, allowing you to send commands to SBE 45 through Interface Box.

*Example: (user input shown in bold)*

```
S>CONNECT45
Connected to SBE 45, press @ or Esc to return to normal mode
S>DS                  (transmitted to SBE 45, so status response is from SBE 45)
SBE45 V 1.1 SERIAL NO. 0059
. . . . (see SBE 45 manual for remainder of SBE 45 status response)
S>OUTPUTSV=N        (do not output sound velocity from SBE 45)
@
mode switched back to normal
S>DS                  (transmitted to Interface Box, so status response is from Interface Box)
SBE45 Junction Box V 1.4
. . . . (see above for remainder of Interface Box status response)
```

**CONNECT38**

Put Interface Box in SBE 38 mode, allowing you to send commands to SBE 38 through Interface Box.

**CONNECTNMEA**

Put Interface Box in NMEA mode, allowing you to look at data *as transmitted* by NMEA navigation device.

**Note:**

See *Data Output Format* in *Section 2: Interface Box Description* for details.

- **FORMAT=1** is not compatible with SEASAVE real-time data acquisition software or SBE Data Processing post-processing software.

**Note:**

Interface Box starts transmitting data automatically when power is turned on and stops when power is removed. Use **STOP** to stop transmitting data temporarily while setting up the instruments, and then restart transmitting data by sending **START**.

**Output Format Command****FORMAT=x**

**x=0:** Output standard format (default)  
 t1=ttt.tttt, c1=cc.ccccc, s =  
 sss.ssss, sv=vvvv.vvv, t2 =  
 ttt.tttt, lat = DD MM.MMMM W,  
 lon = DDD MM.MMMM W, hms =  
 HHMMSS, dmy = DDMMYY

**x=1:** Output custom format for Kongsberg  
 EM 300 Multibeam Echo Sounder  
 tt.ttt vvvv.v

**Sampling Commands****START**

Start transmitting data.

**STOP**

Stop transmitting data.

**Diagnostic Command****\*EETEST**

Test EEPROM; reset baud rates to defaults (new bauds take effect on next power up).

*Example:* (user input shown in bold)

```
S>*eetest
wr: 128
. .
wr: 1920
rd: 256
. .
rd: 1792
passed EEprom test
S>
```



## Setting Up Instruments

### Notes:

- In SEATERM, use the @ character or press the Esc key to exit SBE 45 mode, SBE 38 mode, or NMEA mode and return to Normal mode for communicating with the Interface Box.
- If you reset the baud rate, you may need to turn power off and then on again to resume communications at the new baud rate.

### SBE 45

**Set the SBE 45 J1 jumper to Autopower (pins 1 and 2)** for use with the Interface Box (this is the default setting when the SBE 45 is shipped).

With the SBE 45 directly connected to the computer, set the SBE 45 baud rate with **BAUD=** to match the baud rate set in the Interface Box with **45BAUD=**.

The remaining setup can be performed with the SBE 45 directly connected to the computer, or through the Interface Box. With the Interface Box connected to the computer and SBE 45, send **CONNECT45** to the Interface Box to put the Interface Box in SBE 45 mode and send commands to the SBE 45 through the Interface Box.

- Set up the SBE 45 to begin sampling when power is applied by sending **AUTORUN=Y** and **SINGLESAMPLE=N**.
- Set the other sampling and output parameters for the SBE 45 as desired (see the SBE 45 manual).

### SBE 38

With the SBE 38 directly connected to the computer:

- Set the SBE 38 baud rate with **BAUD=** to match the baud rate set in the Interface Box with **38BAUD=**.
- Set up the SBE 38 to communicate using RS-232 with **INTERFACE=232**.

The remaining setup can be performed with the SBE 38 directly connected to the computer, or through the Interface Box. With the Interface Box connected to the computer, SBE 45, and SBE 38, send **CONNECT38** to the Interface Box to put the Interface Box in SBE 38 mode and send commands to the SBE 38 through the Interface Box.

- Set up the SBE 38 to begin sampling when power is applied by sending **AUTORUN=Y**.
- Set the output format and number of digits with **FORMAT=** and **DIGITS=**. **You must set the format to converted data (FORMAT=C) if you will process the data with SBE Data Processing.**
- Set the other sampling parameters for the SBE 38 as desired (see the SBE 38 manual).

## NMEA Navigation Device

The Interface Box is designed to decode messages that are output from navigation devices supporting NMEA 0183 protocol, outputting messages in GGA, GLL, RMA, RMC, or TRF format. Verify that the navigation device baud rate matches the baud rate set in the Interface Box with **NMEABAUD=** (4800 or 9600).

**Note:**

Not all NMEA navigation devices transmit time and / or date.

The most recent decoded Latitude, Longitude, time, and date data is appended to the end of the SBE 45 data stream in the Interface Box and passed to the computer for storage and/or display with the SBE 45 data. Position data format is detailed in *Appendix I: NMEA Data*. The Yellow *NMEA* LED on the Interface Box flashes each time a NMEA message is received (should be the same rate at which your navigation device is transmitting).

*Example 1:* SBE 45 is set up to output data once every 10 seconds. A navigation device outputs its NMEA message once every 5 seconds. The Yellow *NMEA* LED flashes every 5 seconds. However, only the most recent NMEA message is appended to each scan of SBE 45 data.

*Example 2:* SBE 45 is set up to output data once every 1 second. A navigation device outputs its NMEA message once every 5 seconds, and the Yellow *NMEA* LED flashes every 5 seconds. The same message is appended to each scan of SBE 45 data within that 5 seconds.

While communicating with the Interface Box, send the **CONNECTNMEA** command to view the raw NMEA data.

## Setting Up SBE 45 Configuration (.con) File in SEASAVE

### Notes:

- When we ship a new instrument, we include a .con file that reflects the current instrument configuration as *we know it*. The .con file is named with the instrument serial number, followed with the .con extension. For example, for an SBE 45 with serial number 2375, we name the .con file 2375.con. You may rename the .con file if desired; this will not affect the results.
- The .con file can be viewed and modified in SEASAVE **or** in SBE Data Processing (post-processing software).

The Interface Box integrates optional NMEA navigation device data and optional SBE 38 data into the SBE 45 data stream. SEASAVE, Sea-Bird's real-time data acquisition and display program, stores and displays this data along with the SBE 45 data. SEASAVE requires a .con file, which defines the SBE 45 – which parameters are output by the SBE 45, and the data output rate - and indicates whether NMEA and SBE 38 data is to be appended to the data stream. SEASAVE (as well as our data processing software) uses the .con file to interpret and process the data. **If the .con file does not match the actual instrument configuration, the software will not be able to interpret and process the data correctly.**

To verify the contents of the .con file:

1. Double click on Seasave.exe.
2. In SEASAVE's Configure menu, select *New Style Instrument Configuration/Select Instrument Configuration*. In the dialog box, select the appropriate .con file and click Open.
3. In the Configure menu, select *Modify Selected Instrument Configuration*. The configuration dialog box appears.

Define data in SBE 45 data stream:

- Output conductivity with each scan - Must agree with **OUTPUTCOND=** programmed into SBE 45.
- Output salinity with each scan - Must agree with **OUTPUTSAL=** programmed into SBE 45.
- Output sound velocity with each scan - Must agree with **OUTPUTSV=** programmed into SBE 45.

See reply from status command (**DS**) for setup programmed into SBE 45.

- Use junction box - Select if SBE 45 data transmitted to computer through Interface Box.
- SBE 38 temperature added - Select if Interface Box connected to SBE 38 remote temperature sensor. If selected, SEASAVE and SBE Data Processing (Data Conversion and Derive modules) use remote temperature data when calculating density and sound velocity.
- NMEA data added - Select if Interface Box connected to a NMEA navigation device. SEASAVE automatically adds current latitude, longitude, and universal time code to data header. Select NMEA (Lat/Lon) Interface in SEASAVE's Configure menu to control how Lat/Lon data is incorporated.

Time between scans. Must agree with number programmed into SBE 45 with **INTERVAL=**; see reply from status command (**DS**).

**Configuration for the SBE 45 Thermosalinograph** X

ASCII file opened: None

Sample interval seconds  New

Open...

Save

Save As..

Exit Cancel

**New** to create new .con file.  
**Open** to select different .con file.  
**Save** or **Save As** to save current .con file settings.

4. Click *Save* or *Save As* to save any changes to the .con file.

# Section 4: Operating System

## Note:

For acquiring data in SEASAVE:

- SBE 45 must be set up for autonomous sampling (**SINGLESAMPLE=N**, **AUTORUN=Y**, and J1 jumper in Autopower position – pins 1 and 2). See *Section 3: Setting Up System*.
- Interface Box must be set up with **FORMAT=0** (standard format) and **IMODE=NORMAL** (Normal mode).

This section covers acquiring real-time data with SEASAVE and processing data with SBE Data Processing.

- SEASAVE saves the data in the format (data format and header) required by SBE Data Processing. If you use other software to acquire data, the data will not be in the format required by SBE Data Processing.

See *Connections, Switches, and LEDs* in *Section 2: Interface Box Description* for wiring details.

## Acquiring Real-Time Data with SEASAVE

## Note:

If the system includes an SBE 38 remote temperature sensor, SEASAVE uses the remote temperature data when calculating density and sound velocity.

1. Turn on power to the Interface Box. The SBE 45 will start sampling and transmitting data to the Interface Box. Data will not appear in SEASAVE until you tell SEASAVE to start real-time data acquisition below.
2. Double click on Seasave.exe.
3. In the Configure menu, select *Water Sampler Configuration*. The dialog box looks like this:

Not applicable (selection does not affect operation).

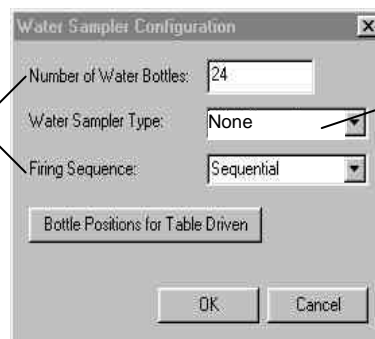

None is only valid selection for system using SBE 45 and Interface Box.

Select *None* for water sampler type, and click OK.

4. Perform any desired setup in the Configure and ScreenDisplay menus.
5. In the RealTime Data menu, select *Start Acquisition*. The dialog box looks like this:

Configuration file defines which parameters are output by SBE 45, SBE 45 data output rate, and whether NMEA and SBE 38 data are appended to data stream. Verify that .con file matches your instrument setup. See *Setting Up SBE 45 Configuration (.con) File in SEASAVE* in *Section 3: Setting Up System*.

Select to save real-time data to a file.

Not applicable.

See Step 6 below.

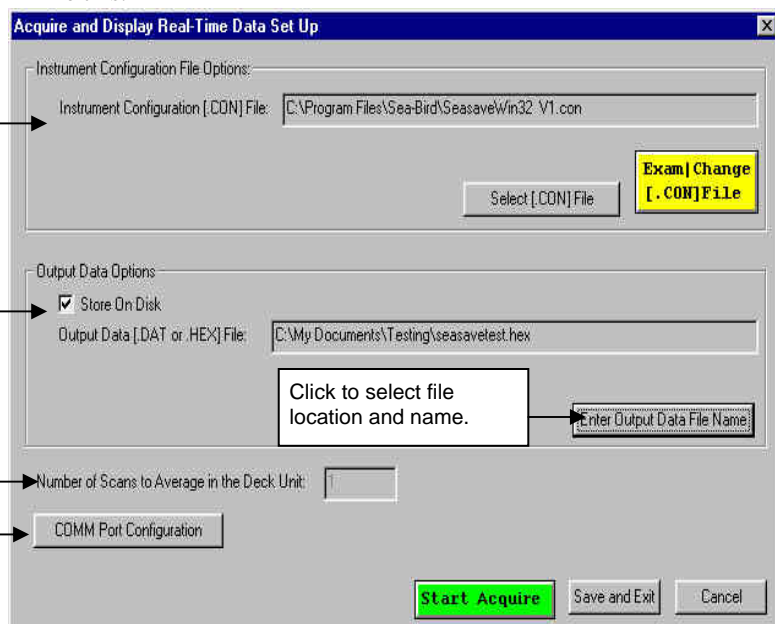

6. Click *COMM Port Configuration*. The dialog box looks like this:

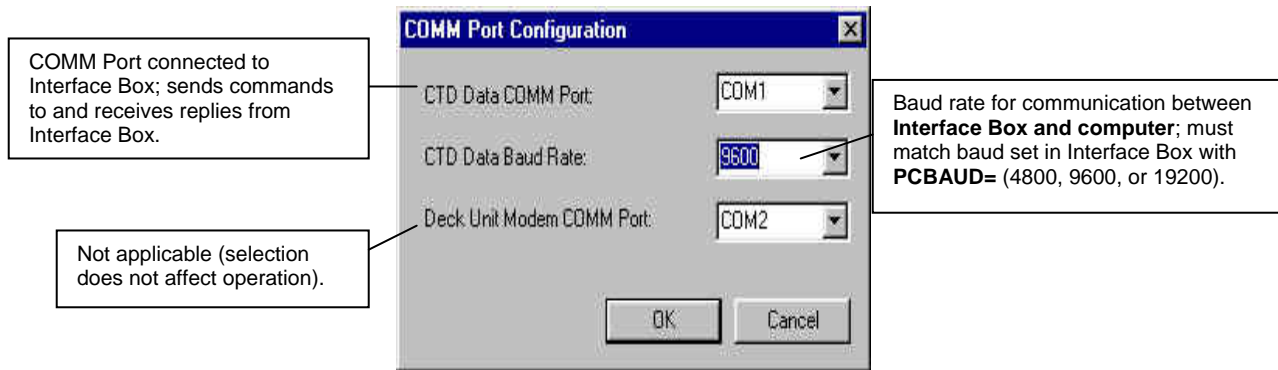

Make the desired selections and click OK.

7. In the *Acquire and Display Real Time Data Set Up* dialog box, click *Start Acquire*.
- If SEASAVE was set up to prompt for header information (Configure menu / Header Form), the Header Information dialog box appears. Fill in the desired information to be added to the header portion of the real-time data acquisition .hex file, and click OK.
  - If the .con file was set to add NMEA data, the screen then displays: *Getting Latitude, Longitude and Time from the NMEA Interface*.
  - SEASAVE prompts *Waiting for data*. If you turned on power to the Interface Box before clicking *Start Acquire*, the data starts appearing in the screen display(s) in a few seconds. SEASAVE will *time out* if data is not received from the Interface Box within 60 seconds.
8. When done acquiring data, in the RealTime Data menu, select *Stop Acquisition*.
9. Close SEASAVE.
10. Stop the SBE 45 sampling by turning off power to the Interface Box.

## Processing Data with SBE Data Processing

**Note:**  
See the SBE Data Processing manual and/or Help files.

- Convert the .hex data file created by SEASAVE to a .cnv file in SBE Data Processing's Data Conversion module.
- Once the data is converted, it can be further processed and plotted in SBE Data Processing's other modules. Note that if the data stream includes SBE 38 remote temperature data, SBE Data Processing's Data Conversion and Derive modules use the remote temperature data when calculating density and sound velocity.

# Section 5: Troubleshooting

This section reviews common problems in operating the Interface Box, and provides the most likely causes and solutions.

---

## Problem 1: Unable to Communicate with Interface Box

The Interface Box message prompt indicates that communications between the Interface Box and computer have been established. Before proceeding with troubleshooting, attempt to establish communications again by clicking the Connect button on SEATERM's toolbar or hitting the Enter key several times.

**Cause/Solution 1:** The I/O cable connection may be loose. Check the cabling between the Interface Box and computer for a loose connection.

**Cause/Solution 2:** The instrument type and/or its communication settings may not have been entered correctly in SEATERM. Select *SBE 45* in the Configure menu and verify the settings in the Configuration Options dialog box. The settings should match those on the instrument Configuration Sheet.

**Cause/Solution 3:** The I/O cable may not be the correct one. The I/O cable supplied with the Interface Box permits connection to the DB-9P input connectors used on standard RS-232 interfaces.

---

## Problem 2: Unable to Communicate with SBE 45 through Interface Box

In SEATERM, while communicating with the Interface Box, send **CONNECT45**. The following message should appear:

```
connected to SBE 45 . . .
```

This indicates that communications between the Interface Box and SBE 45 have been established. If this messages does not appear:

**Cause/Solution 1:** The cable connection may be loose. Check the cabling between the SBE 45 and Interface Box for a loose connection.

**Cause/Solution 2:** The cable between the SBE 45 and Interface Box may not be the correct one. Verify that the cable is the correct one.

**Cause/Solution 3:** The instrument type and/or its communication settings may not have been entered correctly in SEATERM. Select *SBE 45* in the Configure menu and verify the settings in the Configuration Options dialog box. The settings should match those on the instrument Configuration Sheet.

**Cause/Solution 4:** The baud rate for communication between the SBE 45 and Interface Box may not match. The SBE 45's baud rate (set with **BAUD=** when directly communicating with the SBE 45) must be the same as the baud rate set in the Interface Box with **45BAUD=**.

**Cause/Solution 5:** The SBE 45 baud rate may be too high. The baud rate for communication between the Interface Box and computer must be greater than the baud rate between the Interface Box and SBE 45.

- Increase the Interface Box baud rate using **PCBAUD=**.   **Or**
- Connect the SBE 45 directly to the computer and decrease its baud rate using **BAUD=**. Then, with the Interface Box connected to the computer, use **45BAUD=** to match the baud set in the SBE 45.

**Note:**

If applicable, see *Problem 6: Changing SBE 45 and/or SBE 38 Baud Rate without Cables for Direct Connection* below.

### Problem 3: Unable to Communicate with SBE 38 through Interface Box

In SEATERM, while communicating with the Interface Box, send **CONNECT38**. The following message should appear:

```
connected to SBE 38 . . .
```

This indicates that communications between the Interface Box and SBE 38 have been established. If this messages does not appear:

**Cause/Solution 1:** The cable connection may be loose. Check the cabling between the SBE 38 and Interface Box for a loose connection.

**Cause/Solution 2:** The cable between the SBE 38 and Interface Box may not be the correct one. Verify that the cable is the correct one.

**Cause/Solution 3:** The baud rate for communication between the SBE 38 and Interface Box may not match. The SBE 38's baud rate (set with **BAUD=** when directly communicating with the SBE 38) must be the same as the baud rate set in the Interface Box with **38BAUD=**.

**Cause/Solution 4:** The SBE 38 baud rate may be too high. The baud rate for communication between the Interface Box and computer must be greater than the baud rate between the Interface Box and SBE 38.

- Increase the Interface Box baud rate using **PCBAUD=**.   **Or**
- Connect the SBE 38 directly to the computer and decrease its baud rate using **BAUD=**. Then, with the Interface Box connected to the computer, use **38BAUD=** to match the baud set in the SBE 38.

**Note:**

If applicable, see *Problem 6: Changing SBE 45 and/or SBE 38 Baud Rate without Cables for Direct Connection* below.

---

### Problem 4: Unable to Communicate with NMEA Navigation Device through Interface Box

See *Appendix I: NMEA Data* for NMEA troubleshooting.

---

### Problem 5: Nonsense or Unreasonable Data

The symptom of this problem is data that contains nonsense values (for example, 9999.999) or unreasonable values (for example, values that are outside the expected range of the data).

**Cause/Solution 1:** A data file with nonsense values may be caused by incorrect instrument configuration in the .con file. Verify the settings in the .con file match your system.

**Cause/Solution 2:** Unreasonable values may be caused by incorrect calibration coefficients programmed into the instrument. Verify the calibration coefficients in the SBE 45 and (optional) SBE 38 match the Calibration Certificates. To verify calibration coefficients, use **DC** while communicating with each instrument (either directly connected to the computer or through the Interface Box) in SEATERM.

## Problem 6: Changing SBE 45 and/or SBE 38 Baud Rate without Cables for Direct Connection

### Note:

If you have a cable for direct connection of the SBE 45 to the computer and the SBE 38 to the computer, see *Setting Up Instruments in Section 3: Setting Up System* to change the baud rates.

The baud rate for communication between the Interface Box and computer must be greater than the baud rate between the Interface Box and SBE 45 and baud rate between the Interface Box and the SBE 38. If you need to change the baud rate in the SBE 45 and/or SBE 38 for compatibility with the Interface Box, this procedure allows you to change the baud rate while the instrument is communicating through the Interface Box. The procedure is written assuming that the SBE 45 and SBE 38 are set to 9600 baud, but that you want the computer to communicate with the Interface Box at 9600 baud.

In SEATERM:

1. Establish communications with the Interface Box, as described in Steps 1 through 4 in *Communications Test and Setup in Section 3: Setting Up System*.
2. With the Interface Box in Normal mode, send **PCBAUD=19200** to change the baud rate between the Interface Box and the computer to 19200.
3. In the Configure menu, select the SBE 45 and set the baud rate to 19200. Turn power to the Interface Box off, and then on again. The Interface Box is now communicating at 19200 baud.
4. To modify the SBE 45 baud rate:
  - A. Send **45BAUD=9600** to set the baud rate in the Interface Box for communication with the SBE 45 to 9600.
  - B. Send **CONNECT45** to communicate with the SBE 45.
  - C. If the SBE 45 is sampling data, stop sampling by sending **STOP** (you may need to send the command several times).
  - D. Send **BAUD=4800** to set the SBE 45 baud rate to 4800.
  - E. Type @ to return to Normal mode for communication with the Interface Box.
  - F. Send **45BAUD=4800** to set the baud rate in the Interface Box for communication with the SBE 45 to 4800.
5. To modify the SBE 38 baud rate:
  - A. Send **38BAUD=9600** to set the baud rate in the Interface Box for communication with the SBE 38 to 9600.
  - B. Send **CONNECT38** to communicate with the SBE 38.
  - C. If the SBE 38 is sampling data, stop sampling by sending **STOP** (you may need to send the command several times).
  - D. Send **BAUD=4800** to set the SBE 38 baud rate to 4800.
  - E. Type @ to return to Normal mode for communication with the Interface Box.
  - F. Send **38BAUD=4800** to set the baud rate in the Interface Box for communication with the SBE 38 to 4800.
6. Send **PCBAUD=9600** to change the baud rate between the Interface Box and the computer to 9600.
7. In the Configure menu, select the SBE 45 and set the baud rate to 9600. Turn power to the Interface Box off, and then on again. The Interface Box is now communicating with the computer at 9600 baud. If the SBE 45 and SBE 38 are set up to begin sampling when power is applied, data will appear.



# Glossary

**NMEATest** – Sea-Bird’s NMEA message simulation program, which simulates NMEA messages for testing purposes. NMEATest is installed as part of the SBE Data Processing installation.

**PCB** – Printed Circuit Board.

**SBE 45 MicroTSG** – High-accuracy conductivity and temperature monitor.

**SBE Data Processing** – Sea-Bird’s Win 95/98/NT/2000/XP data processing software, which calculates temperature and conductivity, as well as data from auxiliary sensors, and derives variables such as salinity and sound velocity.

**Scan** – One data sample containing temperature and conductivity, as well as data from auxiliary sensors.

**SEASAVE** – Sea-Bird’s Win 95/98/NT/2000/XP software used to acquire, convert, and display real-time or archived raw data.

**SEASOFT-DOS** – Sea-Bird’s complete DOS software package, which includes software for communication, real-time data acquisition, and data analysis and display. SEASOFT-DOS is **not compatible** with the SBE 45 and Interface Box.

**SEASOFT-Win32**– Sea-Bird’s complete Win 95/98/NT/2000/XP software package, which includes software for communication, real-time data acquisition, data analysis and display, and NMEA message simulation. SEASOFT-Win32 includes *SEATERM*, *SeatermAF*, *SEASAVE*, *SBE Data Processing*, and *Plot39*.

**SEATERM** – Sea-Bird’s Win 95/98/NT/2000/XP terminal program used to communicate with the Interface Box and/or the SBE 45. SEATERM can send commands to provide status display, data acquisition setup, data display and capture, and diagnostic tests.

# Appendix I: NMEA Data

## NMEA Raw Message Formats

The Interface Box can interpret NMEA data from a NMEA navigation device if the data is in one of the following formats:

**Notes:**

- -- represents two device-specific characters.
- See the table below for definitions of message parameters.
- <CR> is carriage return.
- <LF> is line feed.

**GGA - Global Positioning System Fix Data**

Time, position, and fix-related data for a GPS receiver.

```
$--GGA,hhmmss.ss,llll.ll,a,yyyyy.yy,b,x,xx,x.x,x.x,M,x.x,M,x.x,xxxx*hh<CR><LF>
```

**GLL - Geographic Position - Latitude/Longitude**

Latitude and Longitude of present position, time of position fix, and status.

```
$--GLL,llll.ll,a,yyyyy.yy,b,hhmmss.ss,A*hh<CR><LF>
```

**RMA - Recommended Minimum Specific Loran-C Data**

Position, course, and speed data provided by a LORAN-C receiver.

```
$--RMA,A,llll.ll,a,yyyyy.yy,b,x,x,x.x,x.x,x.x,x.x,a*hh<CR><LF>
```

**RMC - Recommended Minimum Specific GPS/TRANSIT Data**

Time, date, position, course, and speed data provided by a GPS or TRANSIT navigation receiver.

```
$--RMC,hhmmss.ss,A,llll.ll,a,yyyyy.yy,b,x,x,x.x,ddmmyy,x.x,a*hh<CR><LF>
```

**TRF - TRANSIT Fix Data**

Time, date, position, and information related to a TRANSIT fix.

```
$--TRF,hhmmss.ss,ddmmyy,llll.ll,a,yyyyy.yy,b,x,x,x.x,x.x,xxx,A*hh<CR><LF>
```

where

Field Type	Symbol	Definition
Status	A	Single character field: A = Yes, data valid, warning flag clear V = No, data invalid, warning flag set
Latitude	llll.ll	Fixed/Variable length field: degrees minutes.decimal - 2 fixed digits of degrees, 2 fixed digits of minutes, and variable number of digits for decimal-fraction of minutes. Leading zeros always included for degrees and minutes to maintain fixed length. Decimal point and associated decimal-fraction are optional if full resolution not required.
	a	N or S
Longitude	yyyyy.yy	Fixed/Variable length field: degrees minutes.decimal - 3 fixed digits of degrees, 2 fixed digits of minutes, and variable number of digits for decimal-fraction of minutes. Leading zeros always included for degrees and minutes to maintain fixed length. Decimal point and associated decimal - fraction optional if full resolution not required.
	b	E or W
Time	hhmmss.ss	Fixed/variable length field: hours minutes seconds.decimal - 2 fixed digits of hours, 2 fixed digits of seconds, and variable number of digits for decimal-fraction of seconds. Leading zeros always included for hours, minutes, and seconds to maintain fixed length. Decimal point and associated decimal-fraction optional if full resolution not required.
Checksum	*	Optional Checksum Delimiter.
	hh	Optional Checksum Field: Absolute value calculated by exclusive OR'ing 8 data bits (no start or stop bits) of each character in message, between, but excluding \$ and *.

## Troubleshooting NMEA

### Problem 1: Yellow NMEA LED Not Flashing

**Cause/Solution 1:** Wiring may be incorrect. Check cables and connections between the Interface Box, NMEA navigation device, and computer.

**Cause/Solution 2:** NMEA navigation device may be set to the wrong communication parameters (Interface Box requires 4800 or 9600 baud, 8 data bits, 1 stop bit, and no parity). Reset device's communication parameters. Verify that the baud rate in the Interface Box for communication with the NMEA navigation device is set to match (**NMEABAUD=**), and that the baud rate is less than the baud rate for communication between the Interface Box and the computer.

**Cause/Solution 3:** NMEA navigation device may not be transmitting data. See the device manual for setup details. To verify that it is sending data, connect an oscilloscope with ground on NMEA B (T17) and the probe on NMEA A (T16). The signal should be less than 0.5 volts between messages and have pulses greater than 4 volts for at least 0.2 milliseconds during the message.

**Cause/Solution 4:** Interface Box may not be operating properly. To verify, use the simulation program supplied with SEASOFT-Win32. This program simulates a NMEA navigation device transmitting a NMEA message. See *NMEA Message Simulation Program* for details.

### Problem 2: Yellow NMEA LED Flashing, but Lat/Lon Data Not Displaying

**Cause/Solution 1:** NMEA navigation device may be transmitting NMEA messages in a format that cannot be interpreted by the Interface Box. To verify, view the raw NMEA messages:

1. With the Interface Box running in Normal mode, type **CONNECTNMEA** and press the Enter key to switch to NMEA mode. The display looks like this:

Decode NMEA messages, press @ or Esc to return to normal mode

2. The **raw** NMEA data should begin scrolling on the screen, followed by the **decoded** data. A typical RMC NMEA message is:

```
NMEA: $LGRMC,123113.21,A,3625.12,N,12121.34,W,1.2,4.5,231294,1.2,a*45<CR><LF>
Decoded: , lat=36 25.12 N, lon=121 21.34 W, hms=123113, dmy=231294
```

See *NMEA Raw Message Formats* for a description of all the NMEA messages the Interface Box can decode.

- **If a different NMEA message is received than the Interface Box is set up to decode**, reconfigure your NMEA navigation device to transmit GGA, GLL, RMA, RMC, or TRF.
  - **If no NMEA messages are received in NMEA mode**, the problem could be in the Interface Box, cable, or NMEA navigation device. Verify that the Interface Box is operating properly using the simulation program supplied with SEASOFT-Win32. This program simulates a NMEA navigation device transmitting a NMEA message. See *NMEA Message Simulation Program* for details.
3. Type @ to return to Normal mode.

## NMEA Simulation Program

Sea-Bird provides a NMEA message simulation program, NMEATest, as a troubleshooting aid. NMEATest, part of the SEASOFT-Win32 package, simulates a NMEA navigation device transmitting NMEA messages. If the system does not work with the NMEA navigation device, but works with NMEATest, the problem is with the interface cable from the NMEA navigation device to the Interface Box or in the NMEA navigation device itself.

NMEATest is just a simulation, and does not provide an actual data stream from an actual NMEA navigation device. The data transmission baud rate (4800 or 9600) and time between messages are user-programmable. The NMEA message format (RMA, RMC, GLL, or GGA) generated by the program is also user-programmable. Alternatively, the user can specify an existing raw NMEA data file to use for the simulation; see *NMEA Raw Message Formats* for the required raw data format.

**Note:**

You can also run the simulation using only one computer, if the computer has a spare COM port.

**Note:**

The Interface Box must be connected to the SBE 45 to test the Box, because the Box only transmits a scan of data when data is received from the SBE 45.

To execute the simulation program, a **second computer** (computer 2) is needed to emulate the NMEA navigation device. A laptop computer is adequate for this purpose. Install NMEATest on computer 2 (NMEATest is part of the SBE Data Processing installation).

Use the NMEA Interface test cable (PN 801422 - supplied with the Interface Box) to connect the Interface Box to the simulation computer. The simulation test cable connections are:

MS-3106A12S-3S	DB-9S	Function
Pin A	Pin 3	NMEA A (signal)
Pin B	Pin 5	NMEA B (signal return)

Proceed as follows (instructions are written assuming you are using a second computer to emulate the NMEA navigation device):

1. On computer 1, double click on **Seaterm.exe**.
2. Turn on power to the Interface Box. SEATERM displays:  
SBE 45 Junction Box v 1.4  
Data from the SBE 45 should begin scrolling on the screen.
3. On computer 2, double click on **nmeatest.exe** (in same directory as SBE Data Processing). The NMEATest screen appears.
4. On the NMEATest screen, click on the Configure menu. The Configure dialog box appears. Select:
  - NMEA message to be simulated (RMA, RMC, GLL, or GGA) **or** select an existing NMEA data file on your computer by clicking *Send File* and browsing to the desired file
  - Baud rate (4800 or 9600) for transmission of simulated NMEA data to Interface Box – **must be less than baud rate between Interface Box and computer 1**
  - COMM port on computer 2 for transmission of NMEA data to Interface Box
  - Message interval (time between simulated messages to be transmitted to Interface Box)
 Click OK.

5. On the NMEATest screen, click Start. NMEA data should begin to display on the NMEATest screen. Additionally, NMEA data should begin to display appended to the SBE 45 data in SEATERM on computer 1. The yellow *NMEA* LED should flash on the Interface Box each time the simulation program transmits a new position. The appended data should correspond to the most recent simulation program data. For example, if NMEATest is set to output RMC data:

**NMEATest output -**

RMC: 2212.345,N, 04459.876,E, 15 May 2002 00:00:22

**SEATERM output (appended after SBE 45 data and optional SBE 38 data) -**

lat=22 12.345 N, lon=044 59.877 E, hms=000022, dmy=150502

See *NMEA Raw Message Formats* for the NMEA message formats.

If properly decoded data appears in SEATERM, the Interface Box is working properly. If the system works with the simulation program but does not work when connected to the actual NMEA navigation device, the problem is with the cable from the NMEA navigation device to the Interface Box, or in the NMEA navigation device itself.

- Verify that the cable pinouts are correct, especially at the NMEA navigation device. See *Connections, Switches, and LEDs* in *Section 2: Interface Box Description* and also refer to the NMEA navigation device documentation.
- If the cable is correct, verify that the NMEA navigation device is on and is configured to send data. Many NMEA navigation devices have programmable NMEA outputs and may need to be configured before they will transmit NMEA messages. Refer to the NMEA navigation device documentation, or contact the device's manufacturer for customer support.

# Appendix II: Replacement Parts

Part Number	Part	Application Description	Quantity
171887	DB-9P to DB-9S cable, 3 m (10 ft)	From Interface Box to computer	1
171888	25-pin DB-25S to 9-pin DB-9P cable adapter	For use with computer with DB-25 connector	-
801216	4-pin MCIL-4MP to 4-pin MS3106A-14S-2P cable, 2.5 m (8 ft) long	From SBE 45 to Interface Box	1
80437 or 80438	4-pin RMG-4FS to 4-pin MS-3106A-14S-2P: 80437 – 2.5 m (8 ft) 80438 – 10 m (33 ft)	From SBE 38 to Interface Box	1
801422	2-pin MS-3106A-12S-3S to 9-pin DB-9S NMEA Interface test cable, 1.8 m (6 ft)	From NMEA on Interface Box to computer running NMEA simulation program for test purposes	1
17015	Interface Box AC power cable	Connect Interface Box to AC power source	1
17315	MS-3106A12S-3S connector	2-pin NMEA connector to Interface Box	1
17316	MS3057-4A clamp	Assembled to 17315	1
17317	MS-3420-4 boot	Assembled to 17315	1
17412	MS-3106A-14S-2P	4-pin SBE 45 and SBE 38 connector to Interface Box	2
17413	Clamp	Assembled to 17412	2
17414	Boot	Assembled to 17412	2
17671	MS-3106A-12S-3S	2-pin NMEA connector	1
17413	Clamp	Assembled to 17671	1
17414	Boot	Assembled to 17671	1

# Index

---

.con file · 19

---

## A

About Sea-Bird · 4

---

## B

Baud rate · 8

---

## C

Commands

- baud rate · 14
- diagnostic · 16
- mode · 15
- output format · 16
- sampling · 16
- status · 14

Communications · 8, 12

Configuration file · 19

Connections · 7

---

## D

Data acquisition · 20

Data format · 8

Data processing · 21

Description · 6

---

## F

Format · 8

---

## G

Glossary · 24

---

## I

Installing software · 10

Instrument setup · 17

---

## L

LEDs · 7

---

## N

NMEA · 18

- baud rate · 14, 18
- mode · 15, 18
- raw message formats · 25
- simulation program · 27
- troubleshooting · 26

NMEATest · 6, 10, 27

---

## O

Operating system · 20

---

## P

Parts

- replacement · 29

Power-up

- mode · 15

Processing data · 21

---

## R

Real-time acquisition · 20

Replacement parts · 29

---

## S

SBE 38 · 17

- baud rate · 14, 17

- mode · 15, 17

- setup · 17

SBE 45 · 17

- baud rate · 14, 17

- mode · 15, 17

- setup · 17

SBE Data Processing · 6, 10, 19, 21

SEASAVE · 6, 10, 19, 20

SEASOFT · 6, 10

SEATERM · 6, 10

Setting up instruments · 17

Setup · 11

Simulation program · 27

Software · 6, 10

Specifications · 6

System

- communications · 8

- description · 6

- operation · 20

- wiring · 7

---

## T

Testing · 11

Troubleshooting · 26

---

## U

Unpacking · 5

---

## W

Wiring · 7