



AFWA

AFWA TN-98/002 15 JULY 1998

**Air Force Weather Agency/DNT
Offutt Air Force Base, Nebraska 68113**

Meteorological Techniques

**This technical note is a compilation of
various techniques in forecasting**

- Surface Weather Elements,**
- Flight Weather Elements, and**
- Convective Weather**

APPROVED FOR PUBLIC RELEASE; DISTRIBUTION IS UNLIMITED.

REVIEW AND APPROVAL STATEMENT

AFWA/TN—98/002, *Meteorological Techniques*, 15 July 1998, has been reviewed and is approved for public release. There is no objection to unlimited distribution of this document to the public at large, or by the Defense Technical Information Center (DTIC) to the National Technical Information Service (NTIS).



LARRY E. FREEMAN, Colonel, USAF
Director of Air and Space Sciences

FOR THE COMMANDER

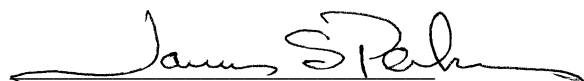

JAMES S. PERKINS
Scientific and Technical Information
Program Manager
15 July 1998

REPORT DOCUMENTATION PAGE

2. Report Date: 15 July 1998
3. Report Type: Technical Note
4. Title: Meteorological Techniques
6. Authors: Capt Maria Reymann, Capt Joe Piasecki, MSgt Fizal Hosein, MSgt Salinda Larabee, TSgt Greg Williams, Mike Jimenez, Debbie Chapdelaine
7. Performing Organization Names and Address: Air Force Weather Agency (AFWA), Offutt AFB IL
8. Performing Organization Report Number: AFWA/TN—98/002
12. Distribution/Availability Statement: Approved for public release; distribution is unlimited.
13. Abstract: Contains weather forecasting techniques of interest to military meteorologists, in three sections: surface weather elements, flight weather elements, and severe weather. Includes both general and geographically specific rules of thumb, results of research, lessons learned from experience, etc, gathered from military and other sources. Update to earlier Air Weather Service Manual 105-56 "Forecasting Techniques."
14. Subject Terms: ATMOSPHERIC PRESSURE, ATMOSPHERIC STABILITY, CLIMATOLOGY, CLOUDS, CONTRAILS, D-VALUES, ICING, PRECIPITATION, SEVERE WEATHER, TEMPERATURE, THUNDERSTORM, TORNADO, TURBULENCE, VISIBILITY, WIND
15. Number of Pages: 242
17. Security Classification of Report: UNCLASSIFIED
18. Security Classification of this Page: UNCLASSIFIED
19. Security Classification of Abstract: UNCLASSIFIED
20. Limitation of Abstract: UL

Standard Form 298

TABLE OF CONTENTS

Abstract	iii
List of Figures	vi
List of Tables	x
Preface	xii
Acknowledgement	xiii
Chapter 1. Surface Weather Elements	1-1
I. Visibility	1-1
A. Dry Obstructions	1-1
B. Moist Obstructions	1-1
C. Visibility Forecasting Rules of Thumb	1-3
D. Forecasting Aids/Techniques	1-17
II. Precipitation	1-23
A. General Guidance	1-23
B. Model Guidance	1-27
C. Determining Precipitation Type	1-27
D. Forecasting Rainfall Amounts	1-34
E. Snowfall	1-38
III. Surface Winds	1-51
A. Wind Basics	1-51
B. General Tools for Forecasting Surface Winds	1-52
C. Specialized Airfield Operations Topics	1-62
D. Forecasting Gusty Surface Winds in the United States	1-66
E. Additional Regional Wind Forecasting Guidance	1-73
IV. Temperature	1-84
A. General Temperature Forecasting Tools	1-84
B. Maximum Temperature Forecasts	1-86
C. Minimum Temperature Forecasts	1-88
D. Some Additional Rules of Thumb	1-88
E. Temperature Indices	1-89
V. Pressure	1-93
A. General Guidance	1-93
B. Pressure-Related Parameters	1-94
Chapter 2. Flight Weather Elements	2-1
I. Clouds	2-1
A. Cloud Types/States of the Sky	2-1
B. General Forecasting Tools	2-3

C. Cloud Forecasting Techniques	2-6
D. Regional Guidance	2-13
II. Turbulence	2-20
A. Levels of Intensity	2-20
B. Aircraft Turbulence Sensitivities	2-21
C. Causes of Turbulence	2-22
D. Clear Air Turbulence	2-23
E. Mountain Wave Turbulence	2-31
F. Wake Turbulence	2-34
G. Forecasting Aids	2-35
III. Aircraft Icing	2-48
A. Icing Processes and Classification	2-48
B. Variables for Determining Icing Accumulation	2-50
C. Meteorological Considerations	2-50
D. Products and Procedures	2-54
E. Standard System Applications	2-57
F. Methods and Rules of Thumb for the –8D Procedure	2-58
G. Summary	2-59
IV. Miscellaneous Weather Elements	2-60
A. Flight Level and Climb Winds	2-60
B. Temperature	2-61
C. Thunderstorms	2-61
D. Contrails	2-62
E. D-values	2-64
Chapter 3. Convective Weather	3-1
I. Thunderstorms	3-1
A. Thunderstorm Types	3-1
II. Synoptic Patterns	3-4
A. Five Classic Synoptic Convective Weather Patterns	3-5
III. Convective Weather Tools	3-12
A. Stability Indices	3-12
B. Evaluation and Techniques	3-17
References	BIB-1
Abbreviations and Acronyms	A-1
Glossary	B-1
Subject Index	IND-1

FIGURES

Figure 1-1.	Whiteout Conditions	1-2
Figure 1-2.	Pre-frontal Fog Associated with Warm Fronts	1-9
Figure 1-3.	Post-frontal Fog Associated with Slow-Moving Cold Fronts	1-10
Figure 1-4.	Radiation Fog	1-11
Figure 1-5.	Continental Shelf in the Northern Gulf of Mexico	1-15
Figure 1-6.	Wintertime Synoptic Pattern for Sea Fog over the Northern Gulf of Mexico	1-15
Figure 1-7a.	Occurrence of Sea Fog	1-16
Figure 1-7b.	Occurrence of Sea Fog	1-16
Figure 1-7c.	Occurrence of Sea Fog	1-16
Figure 1-8.	Occurrence of Steam Fog	1-17
Figure 1-9.	Graphical Method of Determining Fog Occurrence	1-18
Figure 1-10.	Skew-T Method for Estimating the Top of Radiation Fog	1-20
Figure 1-11.	Thermal Ribbon Spacing	1-24
Figure 1-12.	Widespread Precipitation Scenario.	1-24
Figure 1-13.	The 500-mb Product	1-25
Figure 1-14.	Overrunning Associated with a Typical Cyclone.	1-26
Figure 1-15.	Overrunning Precipitation Associated with a Stationary Front.	1-26
Figure 1-16.	Equal Probability of Liquid or Frozen Precipitation.	1-28
Figure 1-17.	Probability of Precipitation being Frozen Versus Liquid.....	1-28
Figure 1-18.	Method 2.	1-29
Figure 1-19.	Determining Precipitation Type by Comparing Thickness.....	1-30
Figure 1-20.	Precipitation-Type Nomogram.	1-30
Figure 1-21.	Precipitation-Type Nomogram.	1-30
Figure 1-22.	Computation of Wet-bulb Temperature at 850 mb	1-31
Figure 1-23.	Computation of Wet-bulb Temperature at 1000 mb.	1-31
Figure 1-24.	Expected Precipitation Type Based on Wet-bulb Temperatures.	1-32
Figure 1-25a.	Maximum Precipitation when the 850-mb Trough is West of the 100° Meridian.	1-35
Figure 1-25b.	Maximum Precipitation when the 850- mb Trough is West of the 100° Meridian	1-35
Figure 1-26a.	Maximum Precipitation, 850 mb Trough East of 100° Meridian	1-36
Figure 1-26b.	Maximum Precipitation, 850 mb Trough East of 100° Meridian	1-36
Figure 1-27.	Snow Index (200 mb) Example	1-39
Figure 1-28a.	A 1200Z Surface Pattern	1-45
Figure 1-28b.	Surface Pattern 24 Hours Later	1-46
Figure 1-29a.	The 1200Z 500-mb Pattern.	1-46
Figure 1-29b.	The 500-mb Pattern 24 Hours Later.	1-46
Figure 1-30.	Heavy Snow Track Pattern 1.	1-47
Figure 1-31.	Heavy Snow Track Pattern 2.	1-47
Figure 1-32.	Heavy Snow Track Pattern 3	1-48
Figure 1-33.	The 500-mb Trough and Associated Snow Areas	1-50
Figure 1-34.	Occluded Front and Location of Snow	1-50
Figure 1-35.	Example of a Trend Chart Used to Forecast “Persistent” Winds.....	1-53
Figure 1-36.	Pressure Gradient Method for Determining Surface Winds.	1-53
Figure 1-37.	Isallobaric Flow.....	1-54
Figure 1-38a.	Variation of Isallobaric Winds by Latitude (25°N)	1-55
Figure 1-38b.	Variation of Isallobaric Winds by Latitude (35°N).....	1-55
Figure 1-38c.	Variation of Isallobaric Winds by Latitude (45°N).....	1-55
Figure 1-38d.	Variation of Isallobaric Winds by Latitude (55°N).....	1-55
Figure 1-38e.	Variation of Isallobaric Winds by Latitude (65°N).....	1-55
Figure 1-38f.	Variation of Isallobaric Winds by Latitude (75°N).....	1-55

Figure 1-39.	Open-Cell Cumulus Shapes	1-58
Figure 1-40.	Strongest Winds in an Extratropical Cyclone.	1-59
Figure 1-41.	Low-level Wind Shear Decision Tree	1-63
Figure 1-42.	High Wind Warning Decision Tree for the Northeast United States.	1-67
Figure 1-43.	High Wind Warning Decision Tree for North Texas.	1-68
Figure 1-44.	Location of “Notorious Wind Boxes.”	1-69
Figure 1-45.	Bradshaw AAF, Hawaii Trade Wind Peak Gust Flowchart.	1-76
Figure 1-46.	Major Wind Systems and Local Names for European Winds	1-77
Figure 1-47.	Southerly Foehn in the European Alpine Region.	1-79
Figure 1-48.	Typical Synoptic Situation Causing an Etesian Wind.	1-80
Figure 1-49.	Typical Synoptic Situation Associated with a Sirocco	1-81
Figure 1-50a.	Typical Synoptic Situation Associated with a Cyclonic Bora in the Adriatic Sea	1-82
Figure 1-50b.	Typical Synoptic Situation Associated with an Anticyclonic Bora in the Adriatic Sea	1-83
Figure 1-51.	Sample Temperature Forecasting Checklist.	1-87
Figure 1-52.	Heat Index	1-90
Figure 1-53.	Fighter Index of Thermal Stress (FITS) Chart	1-91
Figure 1-54.	Index of Thermal Stress (ITS) Chart.	1-92
Figure 1-55a.	Wind Chill Index Charts.	1-92
Figure 1-55b.	Wind Chill Index Charts.	1-93
Figure 1-56.	Pressure Conversion Chart	1-96
Figure 1-57.	Density Altitude Computation Chart	1-98
Figure 1-58.	D-Value Computation Chart	1-99
Figure 2-1.	Cloud Types with Frontal Waves.	2-3
Figure 2-2.	Nephanalysis Example.	2-5
Figure 2-3.	MCL Calculations	2-7
Figure 2-4.	Parcel Method.	2-7
Figure 2-5.	RH and OVV graph.	2-8
Figure 2-6.	Dissipation of Stratus Using Mixing Ratio and Temperature.	2-10
Figure 2-7.	Rule A1	2-11
Figure 2-8.	Rule A2	2-11
Figure 2-9.	Rule A3.	2-11
Figure 2-10.	Rule A4.	2-11
Figure 2-11.	Rule A5	2-11
Figure 2-12.	Rule A6.	2-11
Figure 2-13.	Rule A7.	2-11
Figure 2-14.	Rule A8.	2-11
Figure 2-15.	Rule A9.	2-11
Figure 2-16.	Rule A10.	2-11
Figure 2-17.	Rule A11.	2-11
Figure 2-18.	Rules A12 and A13.	2-11
Figure 2-19.	Rule A14.	2-11
Figure 2-20.	Tropopause Method of Forecasting Cirrus.	2-13
Figure 2-21.	FOEU Bulletin Example.	2-14
Figure 2-22.	Typical Cold-Air Stratocumulus/Stratus Scenario.	2-15
Figure 2-23.	Southwest to Northeast Stationary Front.	2-15
Figure 2-24.	Stationary Front 24 Hours Later.	2-16
Figure 2-25.	Advection of Gulf Stratus with a LLJ.	2-17
Figure 2-26.	Typical Gulf Stratus Coverage.	2-17
Figure 2-27.	Type 1 Gulf Stratus Advection.	2-18

Figure 2-28.	Type 2 Gulf Stratus Advection.	2-18
Figure 2-29.	Type 3 Gulf Stratus Advection.	2-19
Figure 2-30.	Gulf Stratus Advection Track.	2-19
Figure 2-31a.	CAT and Surface Cyclogenesis	2-23
Figure 2-31b.	CAT and Surface Cyclogenesis North of the Main Jet.	2-23
Figure 2-32a.	CAT and upper-level lows	2-24
Figure 2-32b.	CAT and upper-level lows	2-24
Figure 2-32c.	CAT and upper-level lows	2-24
Figure 2-32d.	CAT and upper-level lows	2-24
Figure 2-33.	CAT and the Shear Line in the Throat of an Upper-Level Low	2-25
Figure 2-34.	United Airlines Jet Stream Turbulence Model.	2-25
Figure 2-35.	CAT and Diffluent Wind Patterns.	2-26
Figure 2-36.	CAT and Strong Winds	2-26
Figure 2-37.	Turbulence with Confluent Jets.	2-26
Figure 2-38.	Two Basic Cold-Air Advection Patterns Conducive to CAT.	2-27
Figure 2-39.	Common Open-Isotherm CAT.	2-27
Figure 2-40a.	CAT in Thermal Troughs	2-28
Figure 2-40b.	CAT in Thermal Troughs.	2-28
Figure 2-41.	Closed Isotherm CAT.	2-28
Figure 2-42.	CAT and Shearing Troughs.	2-29
Figure 2-43.	CAT Associated with Strong Wind Maximum to Rear of the Upper Trough.	2-29
Figure 2-44.	CAT in a Deep 500-mb Pressure Trough.	2-29
Figure 2-45.	Double Trough Configuration.	2-30
Figure 2-46.	CAT and Upper-Air Ridges.	2-31
Figure 2-47a.	Mountain-Wave Clouds.	2-31
Figure 2-47b.	Mountain-Wave Clouds.	2-32
Figure 2-48.	Mountain-Wave Nomogram.	2-32
Figure 2-49.	Mountain-Wave Cloud Structure	2-33
Figure 2-50.	Graph of Mountain-Wave Potential.	2-34
Figure 2-51.	Forecasting Checklist for Low-Level Turbulence.	2-35
Figure 2-52.	Turbulence Forecasting from Skew-T.	2-36
Figure 2-53.	Turbulence Nomogram—Temperature Gradient and Surface Winds.	2-37
Figure 2-54.	CAT in a Deformation Zone.	2-39
Figure 2-55.	Clear-Air Turbulence Decision Tree.	2-41
Figure 2-56.	CAT Forecasting—Straight or Slightly Curved Flow.	2-42
Figure 2-57.	CAT Forecasting—Sharply Curved Flow.	2-43
Figure 2-58.	CAT Forecasting—Deformation Zone Patterns.	2-44
Figure 2-59.	CAT Forecasting—with Respect to Comma Cloud.	2-45
Figure 2-60.	CAT Forecasting—Poleward Edge of the Comma Cloud.	2-46
Figure 2-61.	CAT Forecasting—Developing or Steady State Upper-Low with Surface Cyclones.	2-47
Figure 2-62.	Icing Type Based on Temperature.	2-49
Figure 2-63.	Cumuliform Cloud Icing Locations.	2-51
Figure 2-64.	Icing with a Warm Front.	2-52
Figure 2-65.	Icing with a Cold Front.	2-52
Figure 2-66.	Intake Icing.	2-53
Figure 2-67.	Carburetor Icing.	2-53
Figure 2-68.	Icing Flowchart.	2-56
Figure 2-69.	Typical Icing Areas in a Mature Cyclone.	2-57
Figure 2-70.	Bright Band Identification Using the WSR-88D.	2-57
Figure 2-71.	Example of -8D Method.	2-59

Figure 2-72.	Increasing Wind Speed Pattern	2-60
Figure 2-73.	Decreasing Wind Speed Pattern.....	2-60
Figure 2-74.	Jet Contrail Curves on Skew-T.	2-63
Figure 3-1.	Single-Cell Storm Hodograph.	3-1
Figure 3-2.	Typical Multicell Storm Hodograph.	3-1
Figure 3-3.	Supercell Hodograph.	3-2
Figure 3-4.	Classic Supercell.	3-2
Figure 3-5.	Typical High Precipitation (HP) Supercell.	3-3
Figure 3-6.	Low Precipitation (LP) Supercell.	3-3
Figure 3-7a.	Dry Microburst Atmospheric Profile.	3-4
Figure 3-7b.	Wet Microburst Atmospheric Profile.	3-4
Figure 3-7c.	Hybrid Microburst Atmospheric Profile.	3-4
Figure 3-8.	Type “A” Thunderstorm Pattern.	3-6
Figure 3-9.	Type “B” Thunderstorm Pattern.	3-7
Figure 3-10.	Type “C” Thunderstorm Pattern	3-9
Figure 3-11.	Type “D” Thunderstorm Pattern	3-10
Figure 3-12.	Type “E” Thunderstorm Pattern	3-11
Figure 3-13.	Line Echo Wave Pattern, Bow Echo Evolution.	3-21
Figure 3-14.	Bow Echo.	3-21
Figure 3-15.	T2 Gust Computation Chart.....	3-25
Figure 3-16.	Gust Potential Graph.....	3-25
Figure 3-17.	Hail Prediction Chart.	3-27
Figure 3-18.	Skew-T Chart.	3-27
Figure 3-19.	Preliminary hail size nomogram.	3-27
Figure 3-20.	Final Hail Size Nomogram.	3-28

TABLES

Table 1-1.	Conditions favorable for the generation and advection of dust	1-3
Table 1-2.	Visibility limits based on precipitation intensity	1-6
Table 1-3.	Central Europe radiation fog timing guidance	1-11
Table 1-4.	Guidelines for forecasting sea fog and low stratus in the northern Gulf of Mexico from December to March	1-14
Table 1-5.	Fog threat thresholds indicating the likelihood of radiation fog formation	1-19
Table 1-6.	Fog stability index thresholds indicating the likelihood of radiation fog formation	1-19
Table 1-7.	MOS visibility (VIS) categories for the Continental United States and Alaska	1-22
Table 1-8.	MOS Obstruction to Visibility (OBVIS) categories for the Continental United States and Alaska.	1-22
Table 1-9.	Relationship between cloud-top temperatures and showery precipitation.	1-23
Table 1-10a.	CONUS thickness/precipitation thresholds.	1-29
Table 1-10b.	1000-500 mb CONUS thresholds.	1-29
Table 1-11.	Thickness values for determining precipitation type for Korea and Japan.	1-29
Table 1-12a.	Determining precipitation type in the UK and northwestern Europe using 1000- to 500-mb thickness values.	1-30
Table 1-12b.	Determining precipitation type in the UK and northwestern Europe using 1000- to 700-mb thickness values.	1-30
Table 1-13.	Rain/Snow Thresholds	1-31
Table 1-14.	Height of the wet-bulb freezing level (UK and northwestern Europe).....	1-32
Table 1-15.	T1, T3, and T5 values	1-33
Table 1-16.	Probability of snowfall as a function of the height of the freezing level	1-33
Table 1-17.	Freezing precipitation checklist for Europe	1-34
Table 1-18.	Excessive rainfall checklist for the east central United States	1-37
Table 1-19.	Accumulation rates of snowfall as a function of visibility	1-38
Table 1-20.	Lake effect snowstorm checklist.....	1-40
Table 1-21.	Rules of Thumb for forecasting heavy non-convective snowfall	1-41
Table 1-22.	Location of heaviest snow relative to various synoptic features	1-42
Table 1-23.	Synoptic snowstorm types	1-43
Table 1-24.	Cold advection snow checklist for Alaska	1-49
Table 1-25.	Mixing ratio/snowfall duration for Alaskan sites	1-49
Table 1-26a.	Estimating actual windspeed - 30° difference	1-56
Table 1-26b.	Estimating actual windspeed - 60° difference	1-56
Table 1-26c.	Estimating actual windspeed - 90° difference	1-56
Table 1-26d.	Estimating actual windspeed - 120° difference	1-57
Table 1-26e.	Estimating actual windspeed - 150° difference	1-56
Table 1-26f.	Estimating actual windspeed - 180° difference	1-56
Table 1-27.	Increase of wind speed with height	1-60
Table 1-28.	Crosswind component	1-62
Table 1-29a.	Difference of direction, 0° to 12.5°	1-64
Table 1-29b.	Difference of direction, 12.6° to 45°	1-64
Table 1-29c.	Difference of direction, 45.1° to 77.5°	1-64
Table 1-29d.	Difference of direction, 77.6° to 102.5°	1-64
Table 1-29e.	Difference of direction, 102.6° to 135°	1-64
Table 1-29f.	Difference of direction, 135.1° to 167.5°	1-64
Table 1-29g.	Difference of direction, 167.6° to 180°	1-64
Table 1-30.	Table of gradients (700 mb) used in conjunction with Figure 1-44.	1-69
Table 1-31.	Minimum land temperatures (°C) required for a land/sea breeze formation	1-73

Table 1-32.	Craddock’s minimum temperature parameter (in degrees F)	1-88
Table 1-33.	Temperature-Humidity Index (THI) conditions	1-89
Table 1-34.	WBGT impact table	1-91
Table 1-35.	Standard atmospheric pressure and temperature by altitude	1-94
Table 1-36.	Standard atmospheric pressure and temperature by level	1-95
Table 1-37.	Types of altimeter settings	1-95
Table 2-1.	Ceiling height forecast	2-4
Table 2-2.	Precipitation amount forecast	2-4
Table 2-3.	R1, R2, and R3 relative humidity values and cloud amounts	2-5
Table 2-4.	Base of convective clouds using surface dew-point depressions	2-8
Table 2-5.	Determining cloud amounts from dew-point depressions	2-9
Table 2-6.	Gradient and speed relationships	2-17
Table 2-7.	Aircraft category type	2-21
Table 2-8.	Turbulence intensities for different categories of aircraft (based on Table 2-7)	2-21
Table 2-9.	Low-level mountain-wave turbulence	2-32
Table 2-10.	Layers below 9,000 feet using temperature differences	2-37
Table 2-11.	Layers above 9,000 feet using temperature differences	2-37
Table 2-12.	Wind shear critical values	2-38
Table 2-13.	Significant parameter checklist	2-38
Table 2-14.	Unfavorable atmospheric conditions for icing	2-54
Table 2-15.	Favorable atmospheric conditions for icing	2-54
Table 2-16.	Probability of contrail formation	2-64
Table 2-17.	Standard atmosphere	2-64
Table 3-1.	Severe thunderstorm development potential	3-5
Table 3-2.	General thunderstorm (instability) indicators	3-15
Table 3-3.	Severe thunderstorm indicators	3-16
Table 3-4.	Tornado indicators	3-16
Table 3-5.	Product analysis matrix and reasoning	3-18
Table 3-6.	Identifying features of airmass thunderstorm development on upper-air charts	3-20
Table 3-7.	Tornado forecasting tools	3-20
Table 3-8.	Wet microburst potential	3-22
Table 3-9.	T1 convective gust potential	3-24
Table 3-10.	VIL density versus hail size	3-28
Table 3-11.	Stability indices for Alaska	3-28
Table 3-12.	Summary of stability indices for Europe	3-29
Table 3-13.	GMGO thunderstorm severity chart	3-30
Table 3-14.	Critical index values for Korea	3-31

PREFACE

This Meteorological Techniques technical note is a rewrite and update of the old AWSM 105-56 "Forecasting Techniques." It incorporates both old and new rules of thumb, results of studies, lessons learned by experience, etc., from National Weather Service, foreign meteorological services, the former AWS weather wings and MAJCOM directorates of weather, the former AWS and AFWA, and other sources.

We intend it to be updated yearly. We solicit your inputs of techniques you have found successful in observing and forecasting the weather. Especially useful are examples of research results that can be distilled into advice and procedures for the duty forecaster. Please send us your inputs in a Word6.0/Win3.1 format similar to this version; be sure to include a copy of supporting material or list of references. We have produced this tech note as a paper copy in a binder for easy page changes and additions, as well as a CD which incorporates color graphics. We will issue a new CD annually, with paper changes coming at various times of the year, or announced and available for downloading at the AFWA/DNT homepage (URL: http://www.scott.af.mil:81/afwa/dn/dnt/dnt_home.htm).

We have some exciting ideas for the future of this "living document," and hope you will find it useful and contribute to its continued improvement as we move into the reengineered Air Force Weather of the 21st Century.

Air and Space Sciences Directorate
Air Force Weather Agency

ACKNOWLEDGMENT

This technical note represents many hours of hard work by a lot of people across Air Force Weather (AFW). Your dedication and effort yielded a first-class document that will become an indispensable tool for AFW forecasters around the world.

I want to extend my sincere thanks to numerous base weather stations and the major command weather offices for their input, support, and patience.

A special thanks to the following professionals:

Primary Authors:

Capt Maria Reymann
Capt Joe Piaseco
MSgt Fizal Hosein
MSgt Salinda Larabee
TSgt Greg Williams
Mike Jimenez
Debbie Chapdelaine

Primary Reviewers:

Capt David Kohn
Carol Weaver, Ph.D.
Walter Meyer, Ph.D.
James Perkins, STINFO

Graphics:

TSgt Ed Branch

Editors:

H. Gene Newman
Arthur Nelson
Mary Fulton

Lt Col Michael L. Davenport
HQ AFWA/DNT

Chapter 1

Surface Weather Elements

I. VISIBILITY. The *Glossary of Meteorology* defines visibility as “the greatest distance in a given direction at which it is just possible to see and identify with the unaided eye, in the daytime, a prominent dark object against the sky at the horizon or at night, a known, preferably unfocused, moderately intense light source.” Forecasting visibility is a challenge due to the difficulty in predicting the complicated behavior of dry and “moist” (both liquid and solid) airborne particles which obstruct or reduce visibility. A description of these obstructions, some rules of thumb, and several techniques for forecasting visibility are given below.

A. DRY OBSTRUCTIONS (LITHOMETEORS). A lithometeor is the general term for particles suspended in a dry atmosphere; these include dry haze, smoke, dust, and sand.

1. Dry Haze. Dry haze is an accumulation of very fine dust or salt particles in the atmosphere; it does not block light, instead it causes light rays to scatter. Dry haze particles produce a bluish color when viewed against a dark background, but look yellowish when viewed against a lighter background. This light-scattering phenomenon (called *Mie scattering*) also causes the visual ranges within a uniformly dense layer of haze to vary depending on whether the observer is looking into the sun or away from it. Typically, dry haze occurs under a stable atmospheric layer and significantly affects visibility. As a rule, industrial areas and coastal areas are most conducive to dry haze formation.

2. Smoke. Smoke is usually more localized than other visibility restrictions. Accurate visibility forecasts depend on detailed knowledge of the local terrain, surface wind patterns, and smoke sources (including schedules of operation of smoke-generating activities).

3. Blowing Dust and Sand. Wind-blown particles such as blowing dust and sand can cause serious local restrictions to visibility, often reducing

visibility to near zero. The critical wind speed for lifting dust and sand varies according to vegetation, soil type, and soil moisture. Specific forecasting rules vary by station and time of year. The Local Area Forecast Program (LAFP) should document the wind speeds and directions and the surface moisture conditions in which visibility restrictions are most likely to occur.

B. WET OBSTRUCTIONS (HYDROMETEORS). Condensation or sublimation of atmospheric water vapor produces a hydrometeor. It forms in the free atmosphere or at the earth’s surface, and it includes frozen water lifted by the wind. Hydrometeors, which can cause a surface visibility reduction, generally fall into one of the following two categories:

1. Precipitation. Precipitation includes all forms of water particles, both liquid and solid, which fall from the atmosphere and reach the ground; these include: liquid precipitation (drizzle and rain), freezing precipitation (freezing drizzle and freezing rain), and solid (frozen) precipitation (ice pellets, hail, snow, snow pellets, snow grains, and ice crystals).

2. Suspended (Liquid or Solid) Water Particles. Liquid or solid water particles that form and remain suspended in the air (damp haze, cloud, fog, ice fog, and mist) and those liquid or solid water particles that are lifted by the wind from the earth’s surface (drifting snow, blowing snow, blowing spray) cause restrictions to visibility. One of the more unusual causes of reduced visibility due to suspended water/ice particles is whiteout, while the most common cause is fog.

a. Whiteout Conditions. Whiteout is a visibility-restricting phenomenon that occurs when a uniformly overcast layer of clouds overlies a snow- or ice-covered surface. Most whiteouts occur when the cloud deck is relatively low and the sun angle is at about 20° above the horizon. Cloud layers break up and diffuse parallel rays from the sun so that

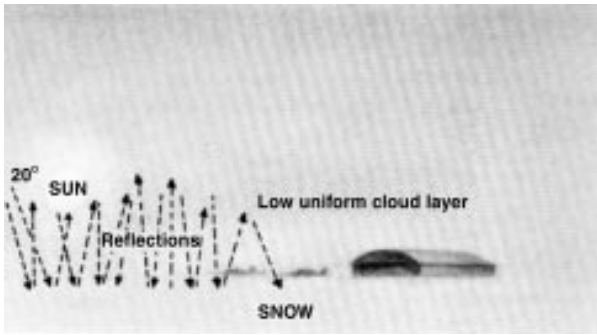

Figure 1-1. Whiteout Conditions. Occur when light reflected back and forth between snow- or ice-covered ground and low stratus clouds

they strike the snow surface from many angles (Figure 1-1). This diffused light reflects back and forth between the snow and clouds until the amount of light coming through the clouds equals the amount reflected off the snow, completely eliminating shadows. The result is a loss of depth perception and an inability to distinguish the boundary between the ground and the sky (i.e., there is no horizon). Low-level flights and landings in these conditions become very dangerous. Several disastrous aircraft crashes have occurred in which whiteout conditions may have been a factor.

b. Fog. Fog is often described as a stratus cloud resting near the ground. Fog forms when the temperature and dew point of the air approach the same value (i.e., dew-point spread is less than 5°F) either through cooling of the air (producing advection, radiation, or upslope fog) or by adding enough moisture to raise the dew point (producing steam or frontal fog). When composed of ice crystals, it is called ice fog.

(1) *Advection fog.* Advection fog forms due to moist air moving over a colder surface, and the resulting cooling of the near-surface air to below its dew-point temperature. Advection fog occurs over both water (e.g., steam fog) and land.

(2) *Radiation fog (ground or valley fog).* Radiational cooling produces this type of fog. Under stable nighttime conditions, long-wave radiation is emitted by the ground; this cools the ground, which causes a temperature inversion. In turn, moist air near the ground cools to its dew point. Depending upon ground moisture content, moisture may

evaporate into the air, raising the dew point of this stable layer, accelerating radiation fog formation.

(3) *Upslope fog (Cheyenne fog).* This type occurs when sloping terrain lifts air, cooling it adiabatically to its dew point and saturation. Upslope fog may be viewed as either a stratus cloud or fog, depending on the point of reference of the observer. Upslope fog generally forms at the higher elevations and builds downward into valleys. This fog can maintain itself at higher wind speeds because of increased lift and adiabatic cooling. Upslope winds more than 10 to 12 knots usually result in stratus rather than fog. The east slope of the Rocky Mountains is a prime location for this type of fog.

(4) *Steam fog (arctic sea smoke).* In northern latitudes, steam fog forms when water vapor is added to air that is much colder, then condenses into fog. It is commonly seen as wisps of vapor emanating from the surface of water. This fog is most common in middle latitudes near lakes and rivers during autumn and early winter, when waters are still warm and colder air masses prevail. A strong inversion confines the upward mixing to a relatively shallow layer within which the fog collects and assumes a uniform density. Under these conditions, the visibility is often 3/16 mile (300 meters) or less.

(5) *Frontal fog.* Associated with frontal zones and frontal passages, this type of fog can be divided into three types: warm-front pre-frontal fog; cold-front post-frontal fog; and frontal-passage fog. Pre- and post-frontal fog are caused by rain falling into cold stable air thus raising the dew point. Frontal-passage fog can occur in a number of situations: when warm and cold air masses, each near saturation, are mixed by very light winds in the frontal zone; when relatively warm air is suddenly cooled over moist ground with the passage of a well-marked precipitation cold front; and in low-latitude summer, where evaporation of frontal-passage rain water cools the surface and overlying air and adds sufficient moisture to form fog.

(6) *Ice fog.* Ice fog is composed of ice crystals instead of water droplets and forms in extremely cold, arctic air (−29°C (−20°F) and colder). Ice fog

of significant density is found near human habitation, in extremely cold air, and where burning of hydrocarbon fuels adds large quantities of water vapor to the air. Steam vents, motor vehicle exhausts, and jet exhausts are major sources of water vapor that produce ice fog. A strong low-level inversion contributes to ice fog formation by trapping and concentrating the moisture in a shallow layer.

In summary, the following characteristics are important to consider when forecasting fog:

- Synoptic situation, time of year, and station climatology.
- Thermal (static) stability of the air, amount of air cooling and moistening expected, wind strength, and dew-point depression.
- Trajectory of the air over types of underlying surfaces (i.e., cooler surfaces or bodies of water).
- Terrain, topography, and land surface characteristics.

C. VISIBILITY FORECASTING RULES OF THUMB.

1. Dry Obstructions - General.

a. Dry Haze. Dry haze layers normally restrict visibility to between 3 to 6 miles and occasionally to less than 1 mile. It usually dissipates when the atmosphere becomes thermally unstable or wind speeds increase. This can occur with heating, advection, or turbulent mixing.

b. Duststorm Generation. Duststorm generation is a function of wind speed and direction and soil moisture content. Table 1-1 lists the conditions favorable for generation and advection of dust.

After generating blowing dust upstream (in a duststorm), wind speed becomes important in advection of the dust. Dust may be advected by winds aloft when surface winds are weak or calm. Duration of the advected dust is a function of the depth of the dust and the advecting wind speeds. Synoptic situations, such as cold frontal passages, may change the wind direction and increase or decrease the probability of dust advecting into your area.

Forecasting dust generation is more difficult than forecasting the advection of observed dust into the area. Important factors to consider include location of favorable source regions, soil dryness, and agricultural practices. Areas where sound soil conservation methods are practiced are less prone to blowing dust. Plant cover protects soil from wind erosion by slowing and breaking wind flow, similar

Table 1-1. Conditions favorable for the generation and advection of dust.

Parameter or Condition	Favorable When
Location With Respect to Source Region	Located Downstream and in Close Proximity
Agricultural Practices	Soil Left Unprotected
Previous Dry Years	Plant Cover Reduced
Wind Speed	≥ 30 kt
Wind Direction	Southwest Through Northwest (Dust Source Upstream)
Cold Front	Passes Through the Area
Squall Line	Passes Through the Area
Leeside Trough	Deepening and Increasing Winds
Thunderstorm	Mature Storm in Local Area or Generates Blowing Dust Upstream
Whirlwind	In Local Area
Time of Day	1200 to 1900L
Surface Dew Point Depression	≥ 10°C
Potential Advection	Blowing Dust Generated Upstream
Wind Speed	≥ 10 kt
Wind Direction	Along Trajectory of the Generated Dust
Synoptic Situation	Ensures the Wind Trajectory Continues to Advect Dust

Chapter 1

to the effects of a snow fence. Conversely, military or civilian operations may disturb the soil, destroy vegetation in an area, and increase the chance for dust generation. Tailor parameters and conditions in Table 1-1 to better help forecast dust affecting customer's operations. Also, do not forget pilot reports (PIREPs); they are helpful in forecasting dust.

2. Dry Obstructions - Regional.

a. Central Japan.

- Weak southeasterly flow causes visibility restrictions in the northern and western Kanto Plain area.

- Visibility restrictions, when they do occur, generally occur up to 2 hours after sunrise and 2 hours before sunset.

- An east to east-northeast wind in summer causes persistent low visibility in smoke and haze.

- Visibility in smoke increases rapidly when winds increase to 10 knots or more.

- No haze or smoke occurs with strong southerly or northerly winds.

- If the dew-point depression is greater than 3.3°C (6°F) between midnight and dawn, haze and smoke do not reduce visibility before sunrise.

- When the dew-point depression is 3.3°C (6°F) or less at 0100L in winter, or 2.8°C (5°F) or less 0100L in spring, haze and smoke reduce visibility in the morning, including the period 0700 to 0900L.

- Haze and smoke usually start dissipating in winter at a temperature of 9°C (48°F).

- Evening visibility becomes unrestricted within 1 hour after the land breeze begins and winds have switched from southeast to northwest.

- Visibility is lower on the following day if there is no air mass change.

- When a strong subsidence inversion is present, restriction to evening visibility may occur as early as 1500L.

b. Southern Japan.

- Generally, visibility is restricted (if smoke and haze is expected) about 2 hours prior to sunrise and sunset.

- If smoke is observed before the daily warming trend begins, it persists until the maximum temperature is reached.

- *c. Okinawa.* Haze and smoke drift in with light breezes from the Naha industrial areas.

- *d. Far East (Yellow Wind).* In spring (April and May), strong winds up to 20,000 feet and higher advect dust, fine sand, and loess (very fine, loose yellowish dust) from northern China and Inner Mongolia into Korea, greatly reducing visibility. The dust has a lesser effect further downstream in Japan and Okinawa. Trailing cold fronts from Mongolian lows often cause the advecting dust. When the low moves past Lake Baikal in Russia, a strong cold air mass pushes the trailing cold front: 24 to 30 hours later into and through Korea, 48 to 56 hours later into and through Japanese stations, and 56 to 60 hours later through Okinawa.

- (1) *Korean Effects.* Yellow Wind events occur 1 to 2 times per year and are reported an average of 3 days per year. They occur within 1 day after an intense cold front passage. The dust lowers visibility to between 2 to 4 miles, and occasionally to 1 mile or less at the surface. Normally, visibility is 3 to 5 miles from 500 feet to 20,000 feet above ground level (AGL), but can be as low as 2 1/2 miles.

- (2) *Okinawan Effects.* Yellow Wind dust occurs 2 to 3 days after intense cold frontal passages during the winter and spring, reducing visibility as low as 2 to 3 miles. Visibility is lowest during the day and improves at night, when the dust settles. This dust often affects visibility to a height of 20,000 feet over Okinawa, and may persist from 1 to 3 days.

- (3) *Japanese Effects.* Visibility is reduced aloft up to 20,000 feet. However, the Japanese Alps block effects on their leeward side, the location of most

United States bases. On the windward side of Japan, dust effects are similar to that over Korea.

e. Saudi Peninsula. Suspended dust, and to a lesser extent, blowing sand and fog, can significantly obstruct visibility in Saudi Arabia. The dust is caused by a combination of a northwesterly channeling effect due to mountain systems and long desert stretches (Tigris-Euphrates River valley) over which the prevailing winds blow. Dust and blowing sand occur year-round, with a maximum occurrence in June and July. In June, reduced visibility occurs an average of 261 hours over the peninsula—the equivalent of 11 days. Although duststorm effects on flying are similar year-round, the cause of these storms varies considerably between winter and summer.

(1) *Winter.* Strong winds due to tightly packed isobars behind winter cold fronts and troughs against the Zagros Mountains in western Iran cause winter sandstorms. Six hours of blowing sand usually accompany the passage of minor low-pressure systems. Sandstorms associated with more intense systems carry dust aloft over all of Iraq and northwest Saudi Arabia. When low-pressure systems closely follow each other, the southerly winds preceding a second system return the suspended dust carried into southern Saudi Arabia by the first system. If the gradient is tight, even more blowing sand and dust occur. Although winter duststorms are usually more intense than summer duststorms, winter duststorms do not last long due to the rapid movement of winter pressure systems.

(2) *Summer.* Periodic increases in the prevailing northwesterly winds during early summer generate clouds of sand and dust along a narrow corridor south of the Zagros Mountains and along the Arabian shore of the Persian Gulf. The lateral extent of these storms is usually small compared to winter storms. This summer Shamal wind may reduce visibility for 5- to 12-day periods during the summer months. Dust is almost continuously raised in the Mesopotamian lowlands (between the Tigris and Euphrates Rivers in Iraq) and transported southeastward in layers up to 12,000 feet thick. Duststorm activity rapidly decreases in Saudi Arabia in August as pressure gradients relax; it reaches an annual minimum in late November.

f. Mediterranean. Salt haze occurs mostly in the summer and early fall and appears bluish white. It scatters and reflects light more than regular dust haze. Salt haze can extend to over 12,000 feet and has been reported as high as 20,000 feet. Although surface visibility may be 4 to 6 miles, the slant range visibility for a pilot making an approach can be near zero if the approach is into the sun. The haze may be thicker aloft than at the surface. Visibility may be less of a problem after sunset. Salt haze is most likely to develop in a stagnant air mass without mixing. This is especially prevalent when there is a strong ridge at the surface and aloft. The haze does not completely disperse until there is an airmass change, but visibility does improve with increased wind speeds at 850 or 700 mb.

3. Moist Obstructions - General.

a. Precipitation. Although there is no one strict rule of thumb relating the intensity of rain to expected visibility, Table 1-2 may be used as a guide to forecast visibility based on the intensity of forecast precipitation; this table may also be used to estimate visibility in snow and drizzle, but only when expecting that particular type of precipitation to occur alone. When forecasting more than one form of precipitation to occur at a particular time, or forecasting fog to occur with the precipitation, consider forecasting a lower visibility than shown in Table 1-2.

b. Blowing snow. Blowing snow due to strong surface winds can greatly reduce horizontal visibility. Visibility of less than 1/4 mile is not unusual in light or moderate snow when the winds exceed 25 knots. The composition of the snow and the effects of local terrain are as important as meteorological factors in forecasting visibility reductions caused by blowing snow. The following forecasting hints may be helpful in forecasting reduced visibility in blowing snow:

- The stronger the wind, the lower the visibility in blowing snow. The converse is also true; visibility usually improves with decreasing wind speed.
- Moderate, dry, and fluffy snowfall with wind speeds exceeding 15 knots usually reduces visibility in blowing snow.

Table 1-2. Visibility limits based on precipitation intensity.

Intensity	Visibility Limits (Statute Miles)
Light rain showers	As low as 5 miles
Moderate rain showers	As low as 2 1/2 miles
Heavy rain showers	As low as 1/2 mile
Light snow showers	> 1/2 mile
Moderate snow showers	> 1/4 mile but < 1/2 mile
Heavy snow showers	≤ 1/4 mile

- Loose snow becomes blowing snow at wind speeds of 10 to 15 knots or greater. Although any blowing snow restricts visibility, the amount of the visibility restriction depends on such factors as terrain, wind speed, snow depth, and composition.

- Snow cover that has previously been subject to wind movement (either blowing or drifting) usually does not produce as severe a visibility restriction as new snow.

- Snow cover that fell when temperatures were near freezing does not blow except in very strong winds.

- Fresh snow drifts or blows at temperatures of -20°C (-4°F) or less. After 3 or more days of exposure to direct sunlight, snow forms a crust and does not readily drift or blow. The crust, however, is seldom uniform across a snowfield. Terrain undulations, shadows, and vegetation often retard the formation of the crust.

- Long-term internal pressure changes in the snow stabilize a snowpack that has been undisturbed for a long period.

- If additional snow falls onto snowpack that has already crusted, only the new snow blows or drifts.

- Blowing snow is a greater hazard to flying operations in polar regions than in mid-latitudes because the colder snow is dry, fine, and easily lifted. Winds may raise the snow 1,000 feet above the ground and lower visibility. A frequent and sudden increase in surface winds in polar regions may cause the visibility to drop from unlimited to near zero within a few minutes.

c. Fog. A general summary of characteristics important to fog formation and dissipation are given here. This is followed by general fog forecasting guidance and guidance specific to advection, radiation, and frontal fogs.

(1) *Formation.* Fog forms by increasing moisture and/or cooling the air. Moisture is increased by the following:

- Precipitation.
- Evaporation from wet surfaces.
- Moisture advection.

Cooling of the air results from the following:

- Radiational cooling.
- Advection over a cold surface.
- Upslope flow.
- Evaporation.

(2) *Dissipation.* Removing moisture and/or heating the air dissipates fog and stratus. Moisture is decreased by the following:

- Turbulent transfer of moisture downward to the surface (e.g., to form dew or frost).
- Turbulent mixing of the fog layer with adjacent drier air.
- Advection of drier air.
- Condensation of the water vapor to clouds.

Heating of the air results from the following:

- Turbulent transport of heat upward from air in contact with warm ground.
- Advection of warmer air.
- Transport of the air over a warmer land surface.

- Adiabatic warming of the air through subsidence or downslope motion.

- Turbulent mixing of the fog layer with adjacent warmer air aloft.

- Release of latent heat associated with the formation of clouds.

(3) *General Forecasting Guidance.* In general:

- Fog may thin after sunrise when the lapse rate becomes moist adiabatic in the first few hundred feet above ground.

- Fog lifts to stratus when the lapse rate approaches dry adiabatic.

- Marked downslope flow prevents fog formation.

- The moister the ground, the higher the probability of fog formation.

- Atmospheric moisture tends to sublimate on snow, making fog formation less likely.

- Rapid formation or clearing of clouds can be decisive in fog formation. Rapid clearing at night after precipitation is especially favorable for the formation of radiation fog.

- The wind speed forecast is important because speed decreases may lead to the formation of radiation fog. Conversely, increases can prevent fog, dissipate radiation fog, or increase the severity of advection fog.

- A combination advection-radiation fog is common at stations near warm water surfaces.

- In areas with high concentrations of atmospheric pollutants, condensation into fog can begin before the relative humidity reaches 100 percent.

- The visibility in fog depends on the amount of water vapor available to form droplets and on the size of the droplets formed. At locations with large amounts of combustion products in the

air, dense fog can occur with a relatively small water vapor content.

- After sunrise, the faster the ground temperature rises, the faster fog and stratus clouds dissipate.

- Solar insolation often lifts radiation fog into thin multiple layers of stratus clouds.

- If solar heating persists and higher clouds do not block surface heating, radiation fog usually dissipates.

- Solar heating may lift advection fog into a single layer of stratus clouds and eventually dissipate the fog if the insolation is sufficiently strong.

(4) *Specific Forecasting Guidance.* Consider the following when faced with advection, radiation, or frontal fog situations.

(a) *Advection Fog.* Advection fog is relatively shallow and accompanied by a surface-based inversion. The depth of this fog increases with increasing wind speed. Other favorable conditions include:

- Light winds, 3 to 9 knots. Greater turbulent mixing associated with wind speeds more than 9 knots usually cause advection fog to lift into a low stratus cloud deck.

- Coastal areas where moist air is advected over water cooled by upwelling. During late afternoon, such fog banks may be advected inland by sea breezes or changing synoptic flow. These fogs usually dissipate over warmer land; if they persist through late afternoon, they can advect well inland after evening cooling and last until convection develops the following morning.

- In winter when warm, moist air flows over colder land. This is commonly seen over the southern or central United States and the coastal areas of Korea and Europe. Because the ground often cools by radiation cooling, fog in these areas is called advection-radiation fog, a combination of radiation and advection fogs.

Chapter 1

- Warm, moist air that is cooled to saturation as it moves over cold water forms *sea fog*:

- If the initial dew point is less than the coldest water temperature, sea fog formation is unlikely. In poleward-moving air, or in air that has previously traversed a warm ocean current, the dew point is usually higher than the cold water temperature.

- Sea fog dissipates if a change in wind direction carries the fog over a warmer surface.

- An increase in the wind speed can temporarily raise a surface fog into a stratus deck. Over very cold water, dense sea fog may persist even with high winds.

- The movement of sea fog onshore to warmer land leads to rapid dissipation. With heating from below, the fog lifts, forming a stratus deck. With further heating, this stratus layer changes into a stratocumulus cloud layer and eventually into convective clouds or dissipates entirely.

(b) *Radiation Fog*. Radiation fog occurs in air with a high dew point. This condition ensures radiation cooling lowers the air temperature to the dew point. The first step in making a good radiation fog forecast is to accurately predict the nighttime minimum temperature. Additional factors include the following:

- Air near the ground becomes saturated. When the ground surface is dry in the early evening, the dew-point temperature of the air may drop slightly during the night due to condensation of some water vapor as dew or frost.

- In calm conditions, this type of fog is limited to a shallow layer near the ground; wind speeds of 2-7 knots bring more moist air in contact with the cool surface and cause the fog layer to thicken. A stronger breeze prevents formation of radiation fog due to mixing with drier air aloft.

- Constant or increasing dew points with height in the lowest 200 to 300 feet, so that slight mixing increases the humidity.

- Stable air mass with cloud cover during the day, clear skies at night, light winds, and moist air near the surface. These conditions often occur with a stationary, high-pressure area.

- Relatively long time for radiational cooling, e.g., long nights and short days associated with late fall and winter in humid climates of the middle latitudes.

- In nearly saturated air, light rainfall will trigger the formation of ground fog.

- In valleys, radiation fog formation is enhanced due to cooling from cold air drainage. This cooled air can result in very dense fog.

- In hilly or mountainous areas, an upper-level type of radiation fog—continental high inversion fog—forms in the winter with moist air underlying a subsiding anticyclone:

- Often a stratus deck forms at the base of the subsidence inversion and lowers. Since the subsiding air above the inversion is relatively clear and dry, air at the top of the cloud deck cools by long-wave radiational cooling which intensifies the inversion and thickens the stratus layer.

- A persistent form of continental high-inversion fog occurs in valleys affected by maritime polar air. The moist maritime air may become trapped in these valleys beneath a subsiding stagnant high-pressure cell for periods of two weeks or longer. Nocturnal long-wave radiational cooling of the maritime air in the valley causes stratus clouds to form for a few hours the first night after the air becomes trapped. These stratus clouds usually dissipate with surface heating the following day. On each successive night, the stratus cloud deck thickens and lasts longer into the next day. The presence of fallen snow adds moisture and reduces daytime warming, further intensifying the stratus and fog. In the absence of airmass changes, eventually the stratus clouds lower to the ground.

- The first indicator of formation of persistent high-inversion fog is the presence of a

well-established, stagnant high-pressure system at the surface and 700-mb level. In addition, a strong subsidence inversion separates very humid air from a dry air mass aloft over the area of interest. The weakening or movement of the high-pressure system and the approach of a surface front dissipates this type of fog.

- Radiation fog sometimes forms about 100 feet (30 meters) above ground and builds downward. When this happens, surface temperature rises sharply. Similarly, an unexpected rise in surface temperature can indicate impending deterioration of visibility and ceiling due to fog.

- Finally, radiation fog dissipates from the edges toward the center. This area is not a favorable area for cumulus or thunderstorm development.

(c) *Frontal fog.* Frontal fog forms from the evaporation of warm precipitation as it falls into drier, colder air in a frontal system.

- Pre-frontal, or warm-frontal, fog (Figure 1-2) is the most common and often occurs over widespread areas ahead of warm fronts.

- Whenever the rain temperature exceeds the wet-bulb temperature of the cold air, fog or stratus form.

- Fog usually dissipates after frontal passage due to increasing temperatures and surface winds.

- Post-frontal, or cold-frontal, fog occurs less frequently than warm-frontal fog.

- Slow-moving, shallow-sloped cold fronts (Figure 1-3), characterized by vertically decreasing winds through the frontal surface, produce persistent, widespread areas of fog and stratus clouds 150 to 250 miles behind the surface frontal position to at least the intersection of the frontal boundary with the 850 mb.

- Strong turbulent mixing behind fast-moving cold fronts, characterized by vertically increasing winds through the frontal surface, often produce stratus clouds but no fog.

4. Moist Obstructions - Regional.

a. *Europe.* The following rules have proven useful in forecasting fog formation in Europe:

- Consider forecasting fog if you expect precipitation, then clearing, and a ridge axis upstream. This is dependent on time of day, season, strength of the ridge, and other factors. Local rules of thumb are beneficial in this case; consult your local TFRN.

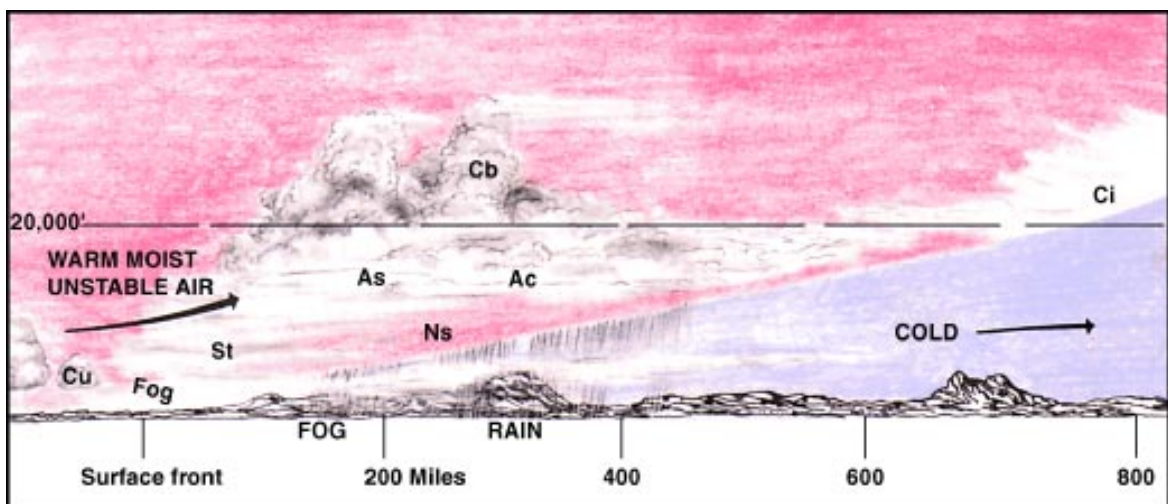

Figure 1-2. Pre-frontal Fog Associated with Warm Fronts. This is most common type of fog, and it often occurs over widespread areas ahead of warm fronts

Chapter 1

- Heating of 3° to 5°C at 850 mb, combined with a slight cooling at the surface, are indicators of an inversion layer formation.

- Do not forecast fog if 850-mb winds (or 925-mb winds) are greater than 15 knots. (Winds below 2,000 feet above ground level should ideally be less than 10 knots).

- Under persistent high pressure, if the 850-mb temperature over the UK is higher than the sea surface temperature, poor visibility covers most of the islands until cooling occurs in the 850- to 500-mb layer.

- Fog is likely today if it occurred yesterday and the synoptic picture has not changed (diurnal persistence).

- The first indicator of the end of a fog episode is a change of flow aloft from anticyclonic to cyclonic.

- Different “Baur weather types” are noted for the foggy conditions they bring to different regions of Europe. Use 2WW’s Europe Map Type Catalogs to associate various synoptic situations with fog (and other weather parameters). Volumes X describes how to use the map type series.

- Frontal Fog. Fog and low ceilings are less common during the summer, but the intrusion of maritime air often brings low ceilings due to

extensive rainfall. When this situation does occur, it is frequently associated with either a cold front from the northwest bringing moist North Sea air into central Europe (upslope flow is generally necessary) or a low moving northeastward from the Bay of Biscay or Spain over France and bringing warm, moist air from the Mediterranean into central Europe.

The following rules are useful in forecasting fog dissipation in Europe:

- In central Europe, forecast radiation fog to last all day if it has not broken by the times listed in Table 1-3.

- Radiation fog becomes persistent from September through early October when flow is anticyclonic southerly or southeasterly, 850-mb temperature is 15°C or greater, and 850-mb wind is less than 15 knots.

- If fog forms, it usually persists until the flow pattern changes, if the latest observed 850-mb temperature is higher than the previous day’s observed surface temperature.

- Forecast fog to be persistent if the following conditions are simultaneously met:

- Anticyclonic southerly to southeasterly flow over central Europe and/or the UK.

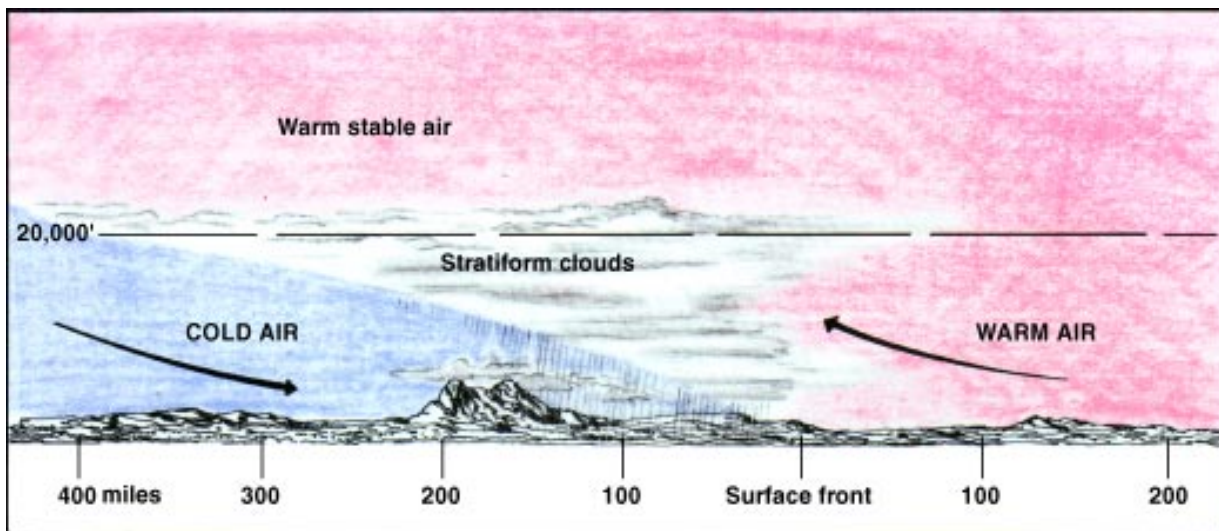

Figure 1-3. Post-frontal Fog Associated with Slow-Moving Cold Fronts. Persistent fog may occur with this type of cold front.

- The previous day’s maximum surface temperature is lower than the current 850-mb temperature on the representative sounding.

- The 850-mb wind speed is less than 15 knots.

- Radiation fog is normally expected to clear (visibility 1,000 meters or greater) when insolation raises the surface temperature to at least a saturated lapse rate from the surface to the fog top (Figure 1-4). Conditions should become 3,000 meters when the surface temperature rises enough to give a dry lapse rate from the surface to the top of the fog. Upslope and downslope effects are not considered with this method. To our knowledge, this technique hasn’t been extensively tested in areas outside the UK.

- If 850-mb winds are between southwest and north, and less than 15 knots, dense fog forms in lower terrain, but dissipates near noon.

- If 850-mb winds are between north and east, check inversion height and strength. Often two or even three inversions form. Fog is then restricted to the lowest levels and usually dissipates quickly, unless the flow is upslope.

- If 850-mb winds are between east-southeast and south-southwest, regardless of speed, and surface winds are east to northeast, fog forms but dissipates very slowly. If the 850-mb temperature at 0000 UTC becomes higher than the maximum temperature of the preceding day, fog is likely to be persistent, unless the surface flow is downslope.

Table 1-3. Central Europe radiation fog timing guidance.

Month	Time
September	09Z
October	10Z
November	11Z
December	12Z
January	12Z
February	01Z

b. United Kingdom. Under persistent high pressure, if the 850-mb temperature is higher than the sea surface temperature, poor visibility covers most of the islands until cooling occurs in the 850- to 500-mb layer.

c. Mediterranean. Fog over the interior regions is usually either radiation or radiation-advection type fog, which form under the control of an initially warm anticyclone. Upslope, advection, sea, and pre-frontal (warm-frontal) fogs account for most of the remainder of fog events. Often, low sun angles and short daylight periods do not create sufficient heating to dissipate the fog.

(1) *Southeastern Mediterranean Fog and Stratus.* In summer, continental tropical (cT) air develops over Middle East countries, the interior of Turkey, and the lowlands around the Caspian Sea. The cT air is drawn into the etesian winds over the Aegean and eastern Mediterranean. Moving over the water, the air cools from below, and its moisture content increases. This results in an inversion up to around 900 to 800 mb (dependent on the distance of the over-water trajectory). If this air returns inland, very low stratus with patches of fog occur in the early morning hours because of radiational cooling overnight. This low stratus is common in the Nile delta, coastal strips of Egypt, Libya, Tunisia and over islands between Tunisia and Sicily from May through September. Southern Turkey experiences short durations of higher stratus/stratocumulus during the summer months, usually occurring in the early morning hours. Afternoon sea breeze moisture invades the area, but it is usually displaced back out to sea as a nighttime drainage

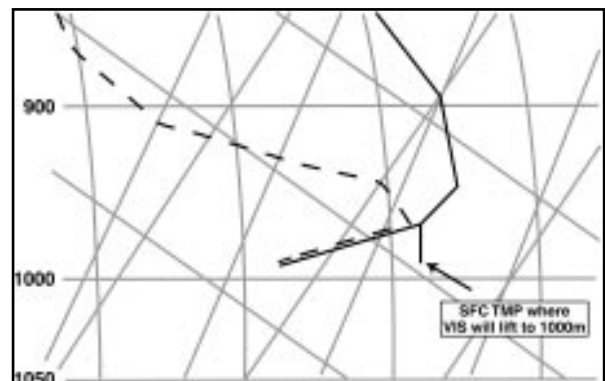

Figure 1-4. Radiation Fog. Dissipation occurs when the surface temperature is raised to the saturated lapse rate of the fog layer

Chapter 1

wind develops or the seasonal etesian wind takes over.

(2) *Winter Fog in the Northern Mediterranean.* (Ebro Valley, Spain; the Po Valley, Pisa and Naples areas, Italy; the Plains of Thessaly near Larissa, Greece and Macedonia; near Thessaloniki, Greece and parts of European Turkey). Winter fog develops under high pressure as soon as cold-air advection stops and an inversion develops. Look for the 0000 UTC 850-mb temperature to be equal to or higher than the surface temperature at 0000 UTC. The 850-mb winds should be southeasterly and less than 20 knots.

d. Northern Japan. Sea Fog is caused by warmer air moving over the cold Oyashio Current, which runs down the eastern shore of Hokkaido and northern Honshu before subducting between 40° and 42°N. It occurs from late spring (May) into late summer (August) when the water and free air temperatures are at their greatest contrast. In addition, the seasonal easterly gradient windflow brings warmer air across this cooler water. Knowing sea surface temperatures (SST) and currents reveals cooler pockets of water where sea fog forms. In addition, identifying low-level windflow determines where this sea fog and stratus advects. The following rules of thumb help forecast sea fog:

- Sea fog forms from late March through August, with maximum occurrences in June and July. Advection sea fog forms when relatively warm air flows over cooler seawaters, and the lower layers cool to condensation. This sea fog pushes onshore with the sea breeze and can extend inland a considerable distance.

- High pressure to the northeast or east that causes easterly flow (northeast through southeast) may lead to sea fog formation. If a strong stationary ridge to the north-northeast of Japan stacks from surface to 300 mb, then sea fog forms.

- When a migrating high reaches 140°E and return flow is easterly, expect advecting sea fog within 48 hours in May and within 12 to 24 hours in June and July.

- Sea stratus below 1,000 feet (with drizzle) occurs within 8 hours after winds become

northeasterly and after a high over the Sea of Okhotsk migrates south.

- Sea fog may form if the dew-point depression is less than 9°C at 1200L and flow is easterly.

- Fog and stratus move over the area and remains persistent if the SST and ambient air temperature difference is small.

- Sea fog is likely if the surface dew point over land is higher than the sea-surface temperature.

- Sea fog does not occur if cold advection occurs in the layer from surface to 850 mb or if the layer is dry.

- Do not expect sea fog or stratus once the SST reaches 20°C (usually late August and September).

- The longer the fetch (path of air over water), the more persistent the sea fog.

- Sea fog occurs in spells. Each spell usually lasts 2 or 3 days, but may last up to 10 days. A sea fog spell may begin as radiational fog and then transition into sea fog. Inside each spell, the sea fog lifts and scatters over the land during the day and lowers or returns in the evening.

- Sea fog persists throughout the day with occasional drizzle if the top reaches 3,000 feet.

- The fog has a tendency to dissipate earlier each day with the progression of spring.

- Sea fog and stratus burn off during the day if the 0500L observed ceiling and/or visibility is greater than 200 feet/1/2 mile, with no broken or overcast deck above.

- Winds more than 20 knots cause sea fog to lift into stratus.

- When the synoptic-scale flow is from the east over the southern half of the peninsula, fog seldom forms to the west of the east coastal mountains. Due to the adiabatic drying effect of this flow, it is responsible for the best visibility.

- Radiation fog usually forms between 0000L to 0400L and usually dissipates between 0700L and 0900L.

e. Central Japan. The following rules apply mainly to the Kanto Plain:

- Fog is persistent when a northeast flow continues in the gradient layer.

- Morning fog occurs when precipitation stops during the night with light winds.

- In spring, radiation fog dissipates by 0900L.

- With the formation of a strong Kanto Low in the afternoon, stratus and fog do not form until the low fills. On these nights the formation does not occur until 0200L or later.

- Suspect fog and stratus on any night the 1600L dew point is 18°C (65°F) or higher.

- Post-frontal fog and stratus seldom forms or persists after the 700-mb trough passes.

- Sea fog persists in early summer in coastal districts with northeast winds.

- Sea fog begins to increase in May and reaches a maximum in July and August and decreases in September.

- Sea fog forms within the southerly air flow on the east side of a low or with the easterly flow on the southern fringes of a high.

- Sea fog persists if associated with a warm front and the air temperature is higher than the SST.

- Sea fog may move inland 12-18 miles.

f. Southern Japan.

- Fog, once formed, persists when a northeasterly flow exists through the gradient level.

- Expect fog with a weak pressure gradient on the southwestern side of a high.

- Morning fog occurs when precipitation stops during the night with light winds.

- Expect dense, persistent fog with light southerly winds from a subtropical high that persists for several days.

g. Okinawa. Fog is rare on Okinawa; when it does form, consider the following:

- Patchy ground fog occurs in moist low areas on nights with strong radiational cooling.

- Expect fog during darkness in spring with east through southeast winds 5 knots or less.

- Sea stratus, not sea fog, forms in spring as a ridge moves to the east of Okinawa. It is formed by southerly flow advecting moist air over cooler water surrounding the island.

h. Korea.

- Most dense fog occurs around sunrise with surface winds from 90° to 120° and speeds 5 knots or less.

- Fog forms over most of central Korea during spring and fall when a migrating high stalls over the peninsula for more than 24 hours.

- Sea fog forms from late March through August with maximum occurrences in June and July.

- Sea fog begins as advection sea fog that forms when relatively warm air flows over cooler seawaters and the lower layers cool to condensation. Once formed, it pushes onshore with the sea breeze and can extend inland a considerable distance.

- The key to forecasting sea fog is to locate colder pockets of water and determine the low-level windflow.

- The following four conditions are necessary for sea fog: relative humidity greater than 70 percent, surface dew point minus sea-surface temperature greater than 0, wind direction of 240° to 320° (on the west coast), and wind speed less than 12 knots.

Chapter 1

• Fog depth depends on the height of the inversion and the amount of turbulent mixing. If the four conditions below are met, consider forecasting radiation fog:

- Winds less than 7 knots, clear skies.
- Thin cirriform cloud cover.
- Radiational cooling dropping the air temperature to equal or nearly equal the dew point.
- Constant or increasing dew points with height in the lower 200 to 500 feet.

i. Alaska. Ice fog is caused by extreme cold temperatures, -32°C (-25°F) and colder, and the availability of water vapor and pollutants in the atmosphere from human activity. Temperature, time, availability of water vapor, and the availability of pollutants control the development of ice fog.

- Ninety-five percent of visibility restrictions below 3 miles and 98 percent of the restrictions below 1/2 mile occur after temperatures drop below -39°C (-39°F).
- Over 99 percent of the time, visibility rapidly improves to above 1 1/2 miles as temperatures warm to -37°C (-34°F) and improves to above 3 miles when the temperature warms to -36°C (-33°F).
- The most likely time for temperatures to grow colder than -39°C (-39°F) is between 0600L and 1000L. During December and January, if

temperatures are colder than -39°C (-39°F), temperatures do not warm to -37°C (-34°F) until a major change in the weather pattern occurs.

- In November, February, and March there is enough solar heating to warm the temperature to above -37°C (-34°F) by 1400L.
- When temperatures are colder than -39°C (-39°F), 2200L to 0300L, there is a 50 percent chance of visibility being above 1/2 mile. At -39°C (-39°F) and colder temperatures, visibility is above 1 1/2 miles only 30 percent of the time at any time of the day.
- When temperatures range from -37° to -39°C (-34° to -39°F), visibility is above 1 1/2 miles 80 percent of the time between 2000L and 0700L, and below 1 1/2 miles 80 percent of the time between 1000L and 1600L.

j. Northern Gulf of Mexico. Sea fog and stratus can affect extensive areas of the northern Gulf of Mexico, especially during winter and early spring months (December to March). Polar and/or arctic outbreaks bring colder air south across the Gulf and cool the shallow waters near the shore. Cooler water from major rivers emptying into the Gulf also adds to the cooling of the immediate coastal waters.

Sea fog during winter and early spring occurs with several synoptic patterns (see Table 1-4). The coldest air masses of the season usually invade the Gulf during January and February, creating ideal conditions for widespread sea fog. The four different types of sea fog identified in the northern

Table 1-4. Guidelines for forecasting sea fog and low stratus in the northern Gulf of Mexico from December to March.

Type of Sea Fog	Ceilings (hundreds of ft)	Visibility (miles)	Occurrence	Frequency %
Warm Advection (cooling)	< 5	< 2	Occasional	50
	5-10	2 < 6	Frequent	
	> 10	≥ 6	Frequent	
Cold Advection (evaporation, steam)	< 5	< 2	Occasional	25
	5-10	2-3	Frequent	
	> 10	> 3	Occasional	
Frontal (along and 50-70 NM north of warm or stationary front)	< 5	< 2	Frequent	20
	5-10	2-4	Occasional	
	> 10	> 4 ≤ 6	Occasional	
Radiational (light wind--clear skies)	≤ 2	≤ 1/2	Frequent	5
	> 2-5	> 1/2 ≤ 2	Occasional	

Gulf are warm advection (cooling), cold advection (evaporation/steam), frontal (mixing), and radiational. Of the four types, warm advection and cold advection fog are most prevalent.

The following synoptic patterns are responsible for sea fog development in the Gulf of Mexico:

(1) *Warm Advection Fog.* High pressure over the southeast United States produces warm advection fog with the return flow from this pattern. Cool air flows out of the high, becomes modified over warmer water, then spreads to the north or

northwest over the northern Gulf. The warm, moist air flowing over the colder, shallower waters of the continental shelf produces the fog. Figure 1-5 shows the location of the continental shelf. The warmer air eventually becomes maritime tropical (mT) if return flow continues long enough before another cold front moves into the Gulf. Figure 1-6 illustrates a typical wintertime synoptic flow pattern that is conducive for the development of advection fog. This is a stable pattern with the prevailing surface wind direction from southeast to southwest (120° to 220°), which brings warm moist air over colder water. The scalloped area denotes areas of potential

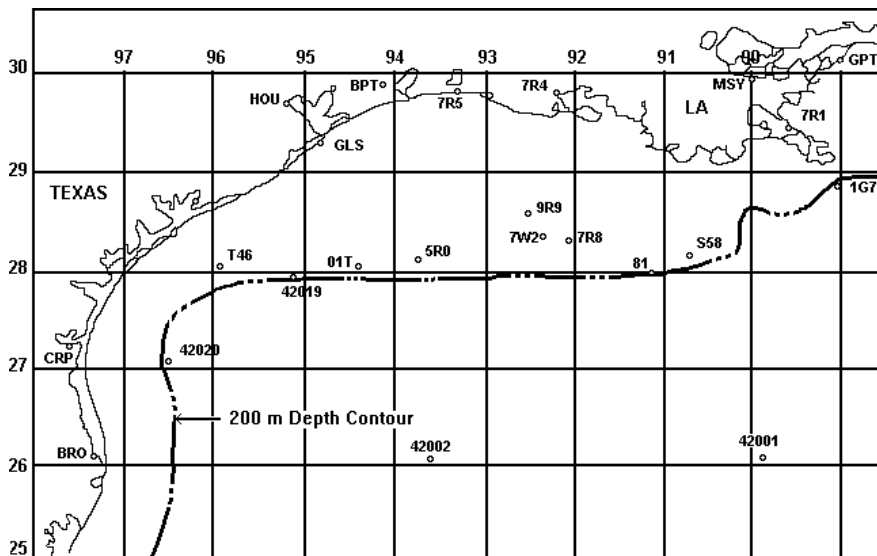

Figure 1-5. Continental Shelf in the Northern Gulf of Mexico. Contour shown at 200-meter depth.

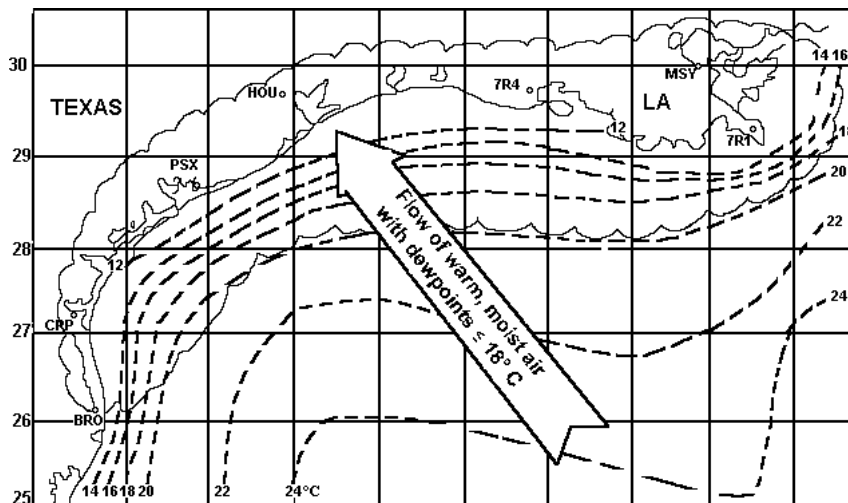

Figure 1-6. Wintertime Synoptic Pattern for Sea Fog over the Northern Gulf of Mexico. This pattern brings warm, moist air over colder water.

Chapter 1

sea fog; dashed lines are sea surface temperatures in °C.

Use Figure 1-7a to help forecast the occurrence of sea fog under these situations. Figures 1-7b and 1-7c give estimates of visibility with sea fog using water temperature (T_w) and dew-point depressions (T_a minus T_d , where T_a is atmospheric temperature).

Sea fog is usually less than 330 feet deep, depending on the wind speed. This type of fog is usually extensive with a long duration. Depending on the synoptic pattern and wind profile, this type of fog could last for several days.

Sea fog duration and dissipation in the northern Gulf of Mexico depends strongly on wind speed, dew point (T_d), and water temperature (T_w).

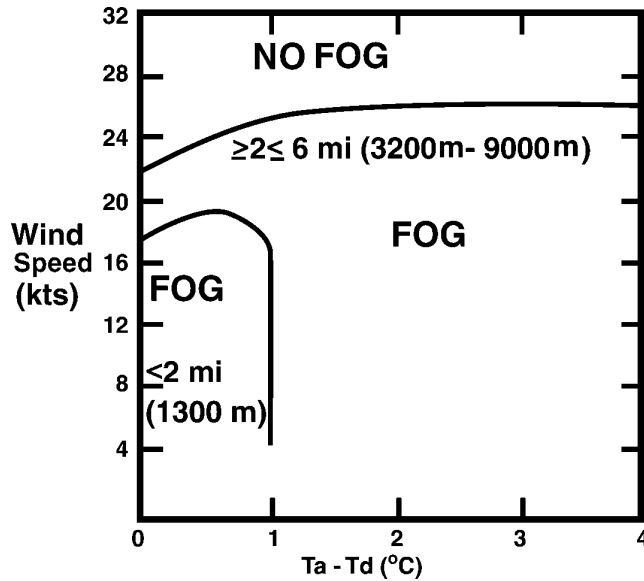

a.

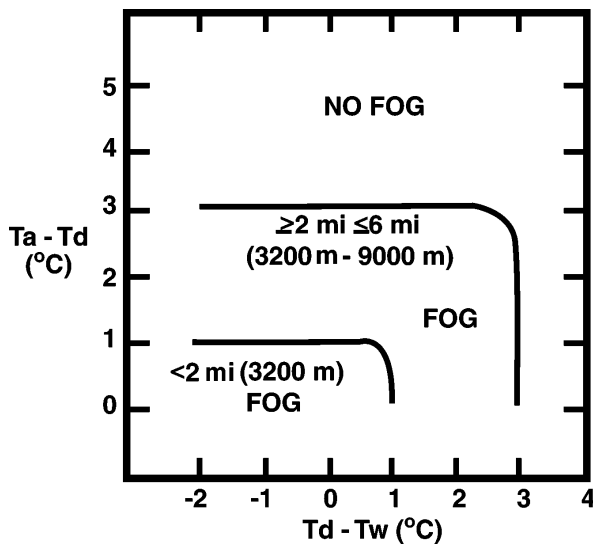

b.

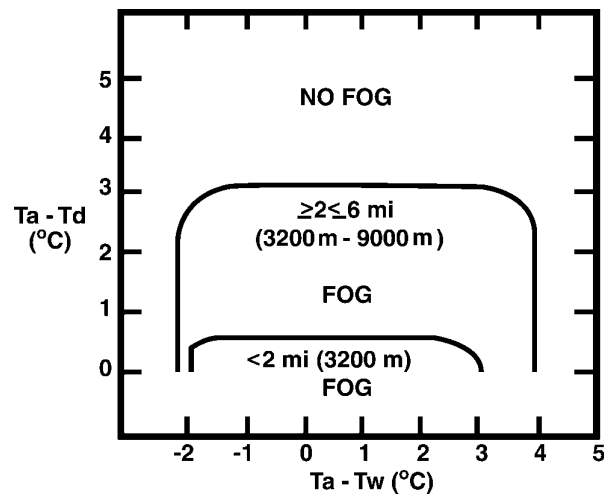

c.

Figures 1-7a, 1-7b, and 1-7c. Occurrence of Sea Fog. Given the synoptic pattern depicted in Figure 1-6, the occurrence of sea fog can be forecast by comparing (a) wind speed and dew-point depression ($T_a - T_d$, where T_a is atmospheric temperature and T_d is dew-point temperature); (b) and (c) show how estimates of visibility can be obtained by using water temperature (T_w) and dew-point depressions.

- T_w of 20°C (68°F) is critical for development of significant sea fog (visibility less than 2 miles).

- T_w of 20° to 24°C (68° to 75°F) causes light to moderate fog (visibility 2 to 6 miles).

- T_w above 24°C (75°F) means fog is unlikely.

- If the dew-point depression (T_a minus T_d) is greater than 3°C (6°F), then fog is unlikely regardless of T_w subtracted from T_a .

- Cold advection causes visibility greater than or equal to 3 miles.

- Fog is unlikely with relative humidities less than 83 percent.

- Dense fog is normally found with relative humidities greater than 90 percent with T_w minus T_a less than or equal to 15°C (59°F).

(2) *Cold Advection Fog.* Strong (winter), cold high pressure over the western United States causes cold advection fog, commonly known as steam fog. Colder air accompanied by moderate-to-strong wind flows south over relatively warmer waters such as

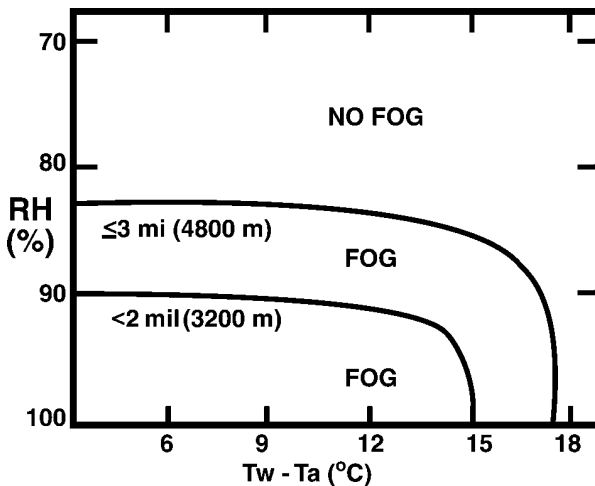

Figure 1-8. Occurrence of Steam Fog. Determine steam fog visibility over the northern Gulf of Mexico by comparing relative humidity with the difference between the air (T_a) and water temperatures (T_w).

the Gulf of Mexico. The wind direction is normally from northwest to northeast (310° to 040°). The lowest visibility is found with relative humidities of 90 percent or greater, and T_a subtracted from T_w less than or equal to 15°C (see Figure 1-8).

- Visibility can be zero even with a north wind of 30 knots.

- This sea fog type forms in an unstable air mass and the fog depth is usually about 110 to 120 feet.

- Steam fog duration is normally less than 18 hours, with dense steam fog typically lasting 6 hours or less.

- Areas of dense steam fog are usually not as widespread as fog.

- Refer back to Table 1-4 for the various ceilings, visibility, and frequency of occurrences with this type of fog.

(3) *Radiation Fog.* High pressure with a weak gradient over the northern Gulf of Mexico causes calm seas with light winds and clear skies. These conditions form a rare type of radiational sea fog.

(4) *Frontal Fog.* A warm or stationary front in the northern Gulf of Mexico causes a frontal type fog commonly known as mixing fog. The fog is formed when warm, moist air overruns a shallow layer (330 to 990 feet) of cold air near the surface, as well as evaporation of warm precipitation into the cold air.

D. VISIBILITY FORECASTING AIDS/TECHNIQUES.

1. *Using Streamlines to Forecast Visibility Near the Coast.* Fog and stratus form near coastlines where moist air flows over cooling land. Surface streamlines can be used to forecast fog and stratus in those areas. To use streamlines effectively, follow three rules:

- Look at all available observations in the area.

- Consider sea surface temperatures. Some of the continental United States (CONUS) area bulletin headings are MTUE KNWC, MTUM KNWC, and MTUW KNWC. Check the U.S. Navy, Internet, or local sources for non-CONUS sea temperatures.

- Refer to a topographical map. The scale must be large enough to show detailed terrain features. Follow the flow over terrain or across land-sea boundaries to identify the heating, cooling, and lifting processes.

2. Graphical Method for Forecasting Fog. This method is valid for short (0 to 4 hours) periods and all times of day. The previous 3- and 6-hour temperature and dew point and graph paper are the only tools required. Use the temperature scale in effect for the period being plotted on the graph. For example, Figure 1-9 shows a Y-axis scale gradation from +4 to -2 because the 6-hour temperature was 4°C and dew point was -2°C. If the 6-hour temperature and dew point was 20°C and 15°C respectively, then use a Y-axis gradation from 20 to 15. Apply the following when using the graph:

- Plot the current temperature (T) and dew point (T_d) on the vertical line labeled “N”.

- Plot the 3-hour old temperature and dew point on the vertical line labeled “N-3”, the 6-hour old data on the “N-6” line.

- Connect the plotted temperature values with a line, extending the line to the right edge of the graph. Similarly, connect the plotted dew-point values and extend this line to the edge of the graph.

- If the lines do not intersect—stop; do not forecast fog for the following 4 hours. If the lines do intersect, from the point of intersection you can find the forecast time by proceeding vertically downward to the time scale. Add “N” to the forecast time to arrive at an onset time for the fog. For example, in Figure 1-9 if the current time was 0900 UTC, then forecast fog at 1200 UTC (0900 + 3 hours).

3. Determining Fog Height. An upper-air sounding taken when fog is present usually shows a surface inversion. If the temperature and dew point remain equal to the top of the inversion, assume fog extends to the top of the inversion. If they are not equal, average the mixing ratio at the top of the inversion and the mixing ratio at the surface. The intersection of this average mixing ratio with the temperature curve is a good estimate of the top of the fog layer.

4. Determining Surface Temperature Needed to:

a. Form Radiation Fog (Fog Point). This value indicates the temperature (°C) at which radiation fog forms. To determine the fog point, find the pressure level of the lifted condensation level (LCL). From the dew point at this pressure level, follow

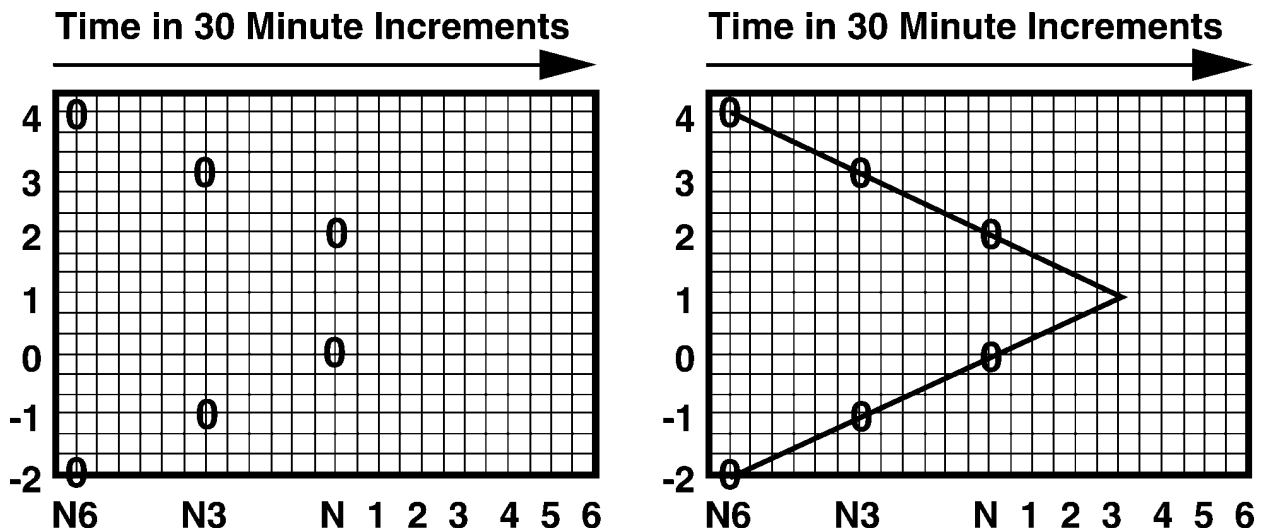

Figure 1-9. Graphical Method of Determining Fog Occurrence. Method uses previous 3- and 6-hour temperatures and dew points.

the saturation mixing ratio line to the surface. The isotherm value at this point is the fog point, or the temperature at which radiation fog forms.

Note: The *British Quick Fog Point (BQFP)*, picked up by UK forecasters while deployed in the former Yugoslavia areas, may also prove useful. *This parameter is valid as long as there is moisture on the ground:*

$$\text{BQFP} = \text{Dew-point temperature } (^\circ\text{C}) \text{ (at max heating)} - 2$$

b. Dissipate Radiation Fog.

Step 1. Determine the average mixing ratio on your local upper air sounding at the lowest 50 to 100 mb of the sounding.

Step 2. Find where the mixing ratio line intersects the temperature curve.

Step 3. Descend from this intersection, dry adiabatically, to the surface pressure. The temperature of the dry adiabat at the surface is the temperature necessary.

Note: The temperature is approximate, since the method assumes no changes take place in the sounding from the time of observation to the time of dissipation.

Step 4. Modify the fog dissipation temperature to reflect changes in local and synoptic scale patterns and local effects.

5. Fog Threat. This value indicates the *potential* of radiation fog formation. It is calculated by subtracting the fog point from the 850-mb wet-bulb potential temperature (WBPT₈₅₀). Refer to Table

Table 1-5. Fog threat thresholds indicating the likelihood of radiation fog formation.

Fog Threat	Likelihood of Radiation Fog
> 3	Low
≥ 0 and ≤ 3	Moderate
< 0	High

1-5 to determine the likelihood of radiation fog formation.

$$\text{Fog Threat} = \text{WBPT}_{850} - \text{Fog Point}$$

6. Fog Stability Index (FSI). The Fog Stability Index (FSI) was developed and tested by Herr Harald Strauss and 2WW for use in Germany in the late 1970s. Using the representative 1200 UTC sounding, the FSI is designed to give you the likelihood of radiation fog formation (see Table 1-6), and is defined as:

$$\text{FSI} = 4\text{T}_{\text{sfc}} - 2(\text{T}_{850} + \text{Td}_{\text{sfc}}) + \text{W}_{850}$$

where,

T_{sfc} = Surface temperature in °C.

T₈₅₀ = 850-mb temperature in °C.

Td_{sfc} = Surface dew point in °C.

W₈₅₀ = 850 mb wind speed in knots.

- Stability from the surface to 850 mb is the main feature and is denoted by the temperature difference between layers.

- Moisture availability is given by the surface temperature and dew-point spread.

- The 850-mb wind speed is included for the amount of atmospheric turbulence in the lower layer.

Note: Thresholds may require some adjustment. Test results showed that this should not be used as the sole predictor. An AWDS command sequence can be made for this parameter. T-TWOS #29 has additional information. The formula may also be entered as an AWDS Skew-T Severe Weather Algorithm.

Table 1-6. Fog stability index thresholds indicating the likelihood of radiation fog formation.

FSI	Likelihood of Radiation Fog
> 55	Low
≥ 31 and ≤ 55	Moderate
< 31	High

7. Skew-T Technique. Note: To our knowledge, this technique hasn't been extensively tested outside the UK. The following technique modifies the 0000 UTC sounding so it is representative of conditions near sunrise. It estimates the top of radiation fog (visibility less than 1,000 meters) at dawn so that a fog dissipation temperature can be forecast. It requires that little or no advection is taking place. The average depth of the radiation inversion is about 35 mb. Once the radiation inversion initially forms, the height of the top of the inversion rarely rises more than 5 mb from its initial height from 0000 to 0600 UTC. The temperature at the top of the inversion decreased on average by 1.5°C. This information is used to construct the following technique for modifying your 0000 UTC sounding for conditions near sunrise; letters in parentheses below refer to Figure 1-10.

- If the nose of the radiation inversion has already formed at 0000 UTC, the top of the inversion is raised by five millibars (A) and the temperature is decreased by 1.5°C (B). This point is joined to the forecast night minimum surface temperature (C) by a straight line on the Skew-T (D). It is assumed that the dew-point curve changes little in the period from midnight to dawn (little or no advection). Therefore, the point where the new temperature curve intersects the 0000 UTC dew-point curve (E) represents the fog top at dawn.

- If a radiation inversion has not formed on the 0000 UTC sounding, the point 35 millibars above the surface is joined to the night minimum surface temperature (without subtracting 1.5°C) and the fog top is estimated as in the above paragraph.

- Use of the Technique in Forecasting Dense Fog. If the forecast temperature curve near the surface shows a significant area of saturation, it stands to reason that dense fog is likely. The theory is similar to that of the fog point in that the amount of low-level moisture is critical to fog formation.

8. Forecasting Visibility Using Climatology. Climatology provides trends and averages of a variety of weather occurrences over a period of years. Consult it first to identify prevailing ceiling and visibility for the location and time of interest. Climatology can also be used to estimate diurnal variations of temperature and dew point at your station as a function of the time of year and general synoptic conditions. There are several AFCCC sources of climatological data available from their homepage or from the Air Force Weather Technical Library (AFWTL).

a. Modeled Ceiling and Visibility (MODCV). MODCV is a software program that provides climatologically based forecasts for ceiling and

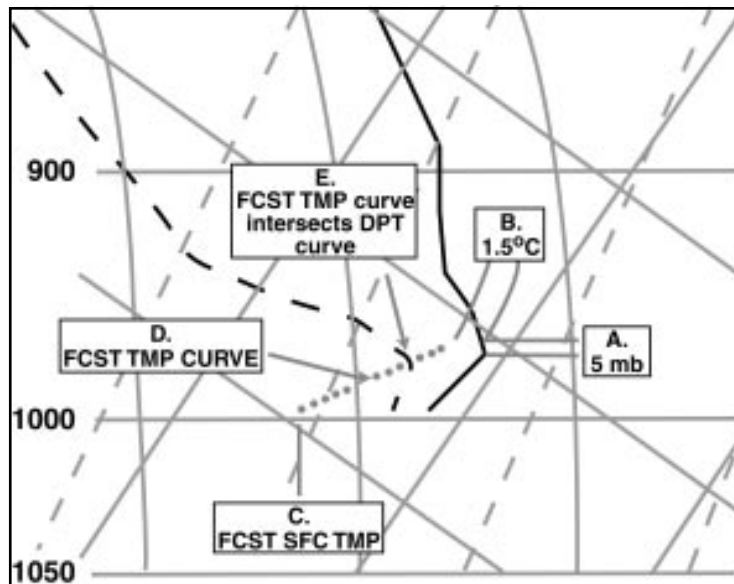

Figure 1-10. Skew-T Method for Estimating the Top of Radiation Fog. Uses data at sunrise to calculate the dissipation temperature.

visibility (MODCV is gradually replacing the older Wind-stratified Conditional Climatology (CC) tables). Use this program as a guide to what is likely to happen based on current conditions. It is best to use MODCV after fog has formed and when conditions will improve. Adjust the display to meet current or expected weather conditions that affect visibility forecasts. This data can prevent over-forecasting an unfamiliar situation or help refine a best-guess forecast.

- MODCV output can be a very valuable tool, but do not use it blindly or indiscriminately. It is based on the month, time of day, wind direction, and the initial ceiling and the visibility category at your station—it only indirectly considers the synoptic situation. It is generally not useful in forecasting low ceilings and visibility due to smoke or duststorms.

- While the numbers in the data are important, the trends they represent are more important. Consider these trends in the light of the normal diurnal changes that take place at your station. Look at the values above and below your category—do they follow the same trends? If the wind sector is near the border of another, look at both sectors and the “all” wind category. If winds are light, look at the “calm” category. Remember look for trends as well as numbers.

- When there are very few observations in the category (less than 10), there may be insufficient examples to make a good forecast. When six or seven cases all follow the same pattern, use these data with a fair degree of confidence. When four or five cases, or the few cases you have, show no set pattern, confidence is low.

b. Modeled Diurnal Curves (MODCURVES).

This product provides summarized parameters including temperature, dew point, and relative humidity by hour for stations from which surface observations are available. The product provides data in monthly increments and includes four wind sectors and two sky cover categories. Values are displayed in graphic and tabular form. These summaries resemble older temperature/dew-point summaries, but are menu driven in a Windows environment.

c. Station Climatic Summaries. These are regional collections of individual station climatic summaries for seven major geographical areas. These summaries normally include monthly and annual climatic data for the following elements: temperature (means and extremes, daily and monthly), relative humidity, vapor pressure, dew point, pressure altitude, surface winds, precipitation, mean cloud cover, thunderstorm and fog occurrence (mean number of days), and flying weather by ceiling and visibility categories. Station climatic summaries include both a station’s SOCS and climatic brief, as described below.

d. Surface Observation Climatic Summaries (SOCS). SOCS contain the percentage frequency of occurrence of ceiling and visibility based on month, time, wind direction, and wind speed. The SOCS replaced the Revised Uniform Summary of Surface Weather Observations (RUSSWO) in July 1988. Each SOCS summarizes hourly observations (and *summary of day* data) for a given weather station in eight categories: atmospheric phenomena; precipitation, snowfall and snow depth; surface wind; ceiling, visibility, and sky cover; temperature and relative humidity; pressure; crosswind summaries; and degree days. Each SOCS includes a Climatic Brief, described below.

e. Climatic Briefs. These are two-page summaries of monthly and annual climatic data for any station with a SOCS, as part of a larger publication entitled Station Climatic Summaries. This product consists of a seven-part series that comprises North America; Latin America; Europe; Africa; Asia; Antarctica, Australia, and Oceania; and USSR, Mongolia, and China. The publications also include collections of the Operational Climatic Data Summaries (OCDS).

f. Operational Climatic Data Summary (OCDS). This product is a summary of monthly and annual climatic data prepared manually when the creation of a standard computerized climatic brief is impractical due to lack of data. The most recent 10-year period of record is used unless more data is available. Data is supplemented from other sources such as earlier periods of record, data from contemporary and/or earlier stations, and published data from other sources.

g. International Station Meteorological Climate Summary (ISMCS). ISMCS is a joint USN/NOAA/USAF-produced CD-ROM that contains station climatic summaries.

h. Regional Climatological Studies. These AFCCC technical notes describe the major meteorological features and seasonal climatic controls on fog and other weather parameters in specific regions of the earth.

i. Theater Climatic Files. These products consolidate climatological information for various regions around the world. The tailored information for each region is provided on one compact disk.

Note: These forecasting aids are available at most weather stations or can be ordered through the AFWTL.

9. Forecasting Visibility Using Model Output Statistics (MOS) Guidance. MOS is an excellent tool to help forecast visibility and vision obstructions. As always, it's important to initialize and verify the model before using MOS.

a. Visibility (VIS). Visibility forecasts are valid every 3 hours from 6 to 36 hours, then every 6 hours from 42 to 60 hours after 0000 and 1200 UTC. In the CONUS and Alaska, MOS visibility forecasts are grouped by categories as shown in Table 1-7.

b. Obstruction to Vision (OBVIS). Visibility forecasts are valid every 3 hours from 6 to 36 hours, then every 6 hours from 42 to 60 hours after 0000 and 1200 UTC. In the CONUS, MOS obstruction-

Table 1-7. MOS visibility (VIS) categories for the Continental United States and Alaska.

MOS VIS Category	Visibility (Miles)
1	< 1/2
2	1/2 < 1
3	1 < 3
4	3 < 5
5	> 5

to-vision forecasts are for one of the categories shown in Table 1-8 for the CONUS and Alaska.

10. Some Final Thoughts on Visibility Forecasting. Experience plays an important role in determining visibility. Note the following:

a. Actual Prevailing Visibility. A drop in visibility (i.e., from 25 miles to 15 miles) could indicate a significant increase in low-level moisture that could go unnoticed if reported as 7+ miles.

b. Sector Visibility. If sector visibility is significantly different from prevailing, it could mean something significant is occurring. For example, the lowering of sector visibility could mean a fog bank is forming or that dust is rising due to an increase in winds from a thunderstorm.

c. Obstructions to Visibility. Reports should include what is obstructing vision (i.e., fog, smoke, haze, etc.) as well as an estimated layer height top and/or base. For example, *visibility 10 miles in haze, top of haze layer approximately 1,500 feet*, includes haze as being the obstruction to vision and identifies the layer of haze.

d. Tops and Bases of Haze Layers. These are important because they may mark the bases of inversions. Tops and bases of haze layers are usually difficult to estimate, but a definite top and/or base is sometimes detectable when looking towards the horizon. Determine the height by noting the orientation to higher terrain, trees, or buildings, if available. Pilot reports of haze tops and/or bases are also useful.

Table 1-8. MOS Obstruction to Visibility (OBVIS) categories for the Continental United States and Alaska.

MOS OBVIS Category	Obstruction to Vision
F	Fog
H	Haze
B	Blowing Phenomena
N	Neither Fog, Haze, nor Blowing Phenomena
X	Missing Data

II. PRECIPITATION. For precipitation to occur, two basic ingredients are necessary: moisture and a mechanism for lifting (i.e., expanding and cooling) the air sufficiently to promote condensation. Lifting mechanisms include convection, orographic lifting, and frontal lifting. There are many techniques and methods available for forecasting precipitation.

A. PRECIPITATION GENERAL GUIDANCE.

1. Extrapolation. Extrapolation works best in short-period forecasting, especially when precipitation is occurring upstream of the station. First, outline areas of continuous, intermittent, and showery precipitation on an hourly or 3-hourly surface product. Use radar and satellite data to refine the surface chart depiction. Use different types of lines, shading, or symbols to distinguish the various types of precipitation. Next, compare the present area to several hourly (or 3-hourly) past positions. If the past motion is reasonably continuous, make extrapolations for several hours. (Note: Consider local effects that may block or slow the movement of the extrapolated area.)

2. Cloud-top Temperatures. The thickness of the cloud layer aloft and the temperatures in the upper-levels of clouds are usually closely related to the type and intensity of precipitation observed at the surface, particularly in the mid-latitudes. Climatology reveals the following:

- In 87 percent of the cases where drizzle was reported at the surface, the cloud-top temperatures were colder than -5°C .
- In 95 percent of the cases during continuous rain or snow, the cloud-top temperatures were colder than -12°C .
- In 81 percent of the cases, intermittent rain or snow fell from the clouds with cloud-top

temperatures colder than -12°C ; in 63 percent of the cases, with cloud-top temperatures colder than -20°C .

Table 1-9 illustrates the relationship between cloud-top temperatures and the probability of showery precipitation in the United Kingdom.

Table 1-9. Relationship between cloud-top temperatures and showery precipitation.

Cloud-top Temperature	Shower Probability
0° to -12°C	Slight possibility
-13° to -40°C	Likely
Below -40°C	Almost certain

3. Dew-point Depression. An upper-level dew-point depression less than or equal to 2°C is a good predictor of both overcast skies and precipitation. Dew-point spreads less than or equal to 2°C on the 850- and 700-mb forecast products are a good indication of potential precipitation, assuming there is potential for upward vertical motion.

4. Associating Precipitation with Fronts.

a. Cold fronts. A cold front moving southeastward into the central and eastern United States may produce widespread, prolonged poor weather. After passage of the cold front, a band of stratiform ceilings with fog, drizzle, rain or frequent snow 200 to 500 miles wide often forms behind the front, bringing several days of bad weather.

(1) Synoptic Pattern. With the following sequence of events, expect widespread post-frontal weather.

- A cold front moves into the area east of the Rockies, followed by a rather shallow dome of cold continental air.

- Figure 1-11 shows a thermal ribbon at 500 mb. Do not consider an area part of the ribbon when the isotherm spacing becomes greater than 150 miles.

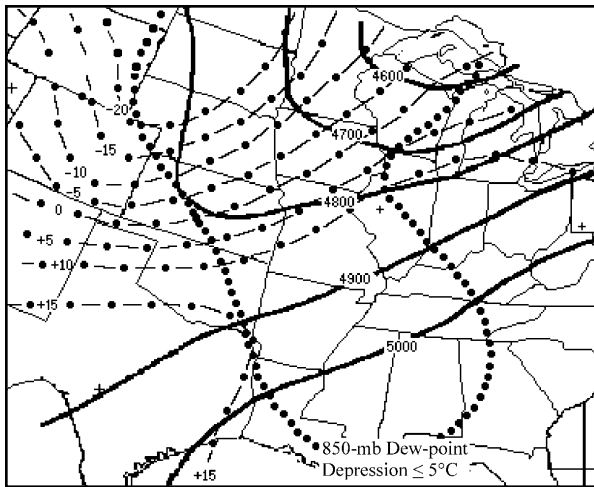

Figure 1-11. Thermal Ribbon Spacing. A thermal ribbon is three or more nearly parallel isotherms in 5°C increments with spacing between isotherms about 50 to 150 miles.

The 24-hour forecast position of the 500-mb trough remains west of the affected area. Any northerly flow below 500 mb tends to disrupt the thermal field.

- The pre-trough air at 850 mb has a dew-point depression of 5°C or less.
- The 500-mb system must lag behind the short-wave 850-mb trough. Weather in this post-cold frontal pattern normally includes the usual low ceilings and gusty surface winds associated with the cold front. Expect the worst conditions 25 to 75 miles behind the front where ceilings are 200 to 600 feet and visibility of 1/2 to 2 miles can occur in rain, snow, and fog. From 75 to 150 miles behind the front, ceilings average 500 to 1,000 feet with rain or snow and possibly freezing rain. Beyond the 150-mile range, ceilings are above 1,000 feet with rain or snow showers. In most cases, a band of freezing rain is present in areas between the 850-mb 0°C and surface 0°C isotherms.

The orientation of the front is also an important indicator of the nature of the post-frontal weather. Weather associated with east-west oriented cold fronts usually extends 500 miles to the rear of the

front; weather associated with more northerly oriented fronts (050° to 230°) usually extends only 200 miles behind the front. In general, the more east-west the frontal system, the slower the weather pattern movement. Note the extent of precipitation with the east-west orientation of the surface front in Figure 1-12.

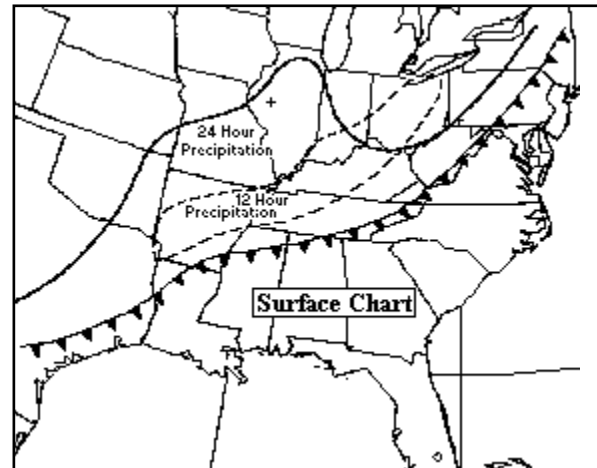

Figure 1-12. Widespread Precipitation Scenario. The resulting spread of precipitation 24 hours after the system shown in Figure 1-13.

(2) *Forecasting Procedures for Post-Frontal Precipitation and Weather.*

Step 1. Determine whether a packed thermal gradient on the 850-mb chart is present.

Step 2. Forecast the 24-hour movement of the 500-mb trough. If the forecast calls for eastward movement or the retrogression of the 500-mb trough, the flow at 850 mb behind the trough decays and leaves the isotherm ribbon in an area of weak flow. This decay generally proceeds from south to north. If the 500-mb trough progresses normally with the 850-mb trough, the thermal ribbon moves with the surface front and widespread post-frontal weather does not form.

Step 3. Determine if the 850-mb pre-trough air has dew-point depressions of 5°C or less. See Figure 1-13.

Note: If all three of the above are present, then conditions are potentially good for widespread post-frontal weather and proceed with Steps 4 and 5.

Step 4. Forecast the 24- and 30-hour position of the surface cold front.

Weather persists until one of the following occurs:

- The 700-mb trough axis passes east of the area.
- Cyclogenesis takes place and associated temperature advection disturbs the pattern.
- A new cold front moves in, breaking the pattern.

Step 5. Forecast the area of bad weather by using the cold front as its leading edge. If the front is oriented more north-south than a 50° to 230° axis, expect bad weather to stretch 200 miles behind the front. If the front is more east-west than a 50° to 230° axis, expand the area to 500 miles (see Figure 1-12).

In any case, bad weather persists until active cold-air advection is established. In persistent cases of poor post-frontal weather, the southerly flow gradually modifies the thermal field while intermittent precipitation lowers ceilings and visibility. When cyclogenesis occurs in an area of persistent post-frontal weather in the Midwest, the added vertical motion produces bad weather over the entire eastern United States.

b. Warm Front—Overrunning. Overrunning precipitation occurs in association with active warm fronts, surface cyclones passing south of your station, stationary fronts, and to a lesser degree, with slow-moving cold fronts. Stratus is a by-product and generally results from the evaporation of relatively warm precipitation into cooler air. The cold-air sections of a cyclone or frontal zone must have precipitation to have overrunning conditions.

Use 925-mb or 850-mb (whichever is more applicable for your location) and 700-mb products to determine whether sufficient moisture and sufficient vertical motion are present to produce overrunning precipitation:

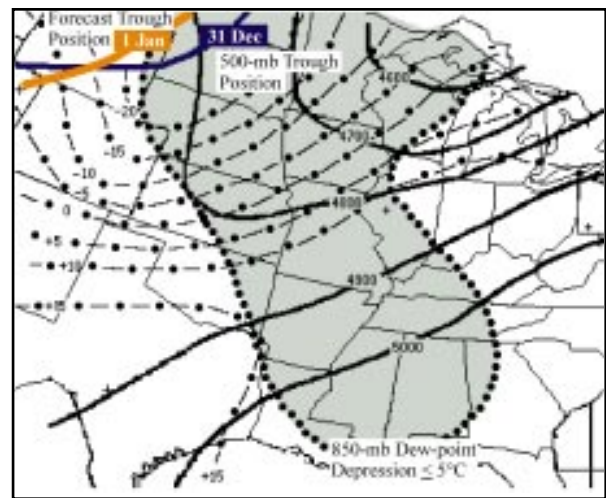

Figure 1-13. The 500-mb Product. The 500-mb trough retrogrades slightly on the northern end and moves slowly east to the southern end. Within 24 hours, the 850-mb winds over the ribbon south of the Great Lakes had fallen to almost calm.

- The 925-mb or 850-mb product reveals if the available moisture to the south and the wind flow are favorable for the advection of this moisture into the area.

- The 700-mb product reveals if the thermal structure is adequate to produce overrunning precipitation. In general, overrunning requires warm-air advection and cyclonic curvature at 700 mb to produce significant precipitation. Therefore, the outer limits of overrunning precipitation are usually the 700-mb ridge line in advance of the system (beginning of precipitation) and behind the system where the wind changes from veering with height (warm-air advection) to backing with height (cold-air advection and the ending of precipitation).

Figure 1-14 is an idealized model of an overrunning precipitation pattern that occurs with an active warm front to the north of a surface cyclone. Figure 1-15 depicts stationary front type overrunning. The location of the precipitation area is dependent upon the moisture source. In this case, the moisture is of maritime Polar (mP) origin. Had it originated in the Gulf of Mexico, the precipitation area would displace further south.

Forecasting the onset of overrunning precipitation associated with a stationary front is a difficult task

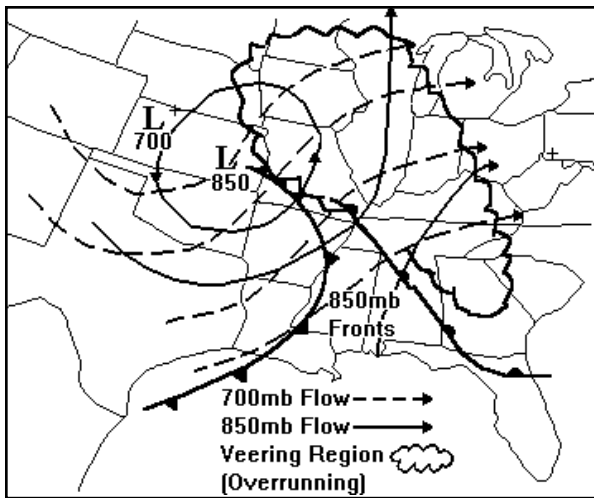

Figure 1-14. Overrunning Associated with a Typical Cyclone. This pattern occurs with an active warm front to the north of a surface cyclone

near the surface front. The primary concern is moisture advection over the top of the cold air (consider the 925-mb or 850-mb product first). During the long time span between 850-mb products, monitor other data, especially those close to a moisture source. A good indicator is the increase of low-level cloudiness at the warm stations upstream. Advect this moisture at the speed of the low-level winds. Dissipation takes place with one of the following two occurrences:

- When an upper-level short wave (watch upper-level analysis and vorticity forecasts) forms a low on the stationary front and the low moves through.
- When the 700-mb flow changes from cyclonic curvature to anticyclonic curvature.

5. Drizzle Formation. The basic requirements for significant drizzle are:

- A cloud layer or fog at least 2,000-feet deep.
- Cloud layer or fog must persist several hours to allow droplets time to form.
- Sufficient upward vertical motion to maintain the cloud layer or fog.
- A source of moisture to maintain the cloud or fog. (Light drizzle can fall from radiation and sea fog without the help of upward vertical motions).

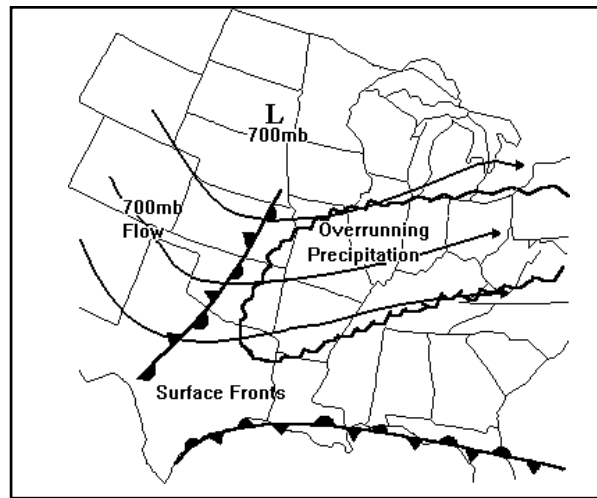

Figure 1-15. Overrunning Precipitation Associated with a Stationary Front. This type of overrunning occurs well to the north of the surface frontal zone.

Except for the upward motion, the requirements for drizzle can be determined by inspecting products. Vertical motion at 700 mb generally is not relevant to fog and stratus. The 850-mb Q-vectors may be useful at stations at elevations closer to 850 mb.

Note: T-TWOS #1 has detailed information on Q-vectors and their applications.

The vertical motion of concern is near the ground; identify it by drawing streamlines on surface work charts to locate and track local axes of confluence. Make a reasonable estimate of whether surface confluence is stronger or weaker than usual. Drizzle onset is faster and more likely with stronger confluence.

Sometimes upslope flow and sea breeze confluence produces the gentle vertical motion needed without observations that indicate local confluence. Similarly, persistent large-scale southerly flow naturally converges as it moves northward and can provide the needed low-level gentle upward motion. Finally, the lift associated with the front supplies the needed upward motion to generate large areas of fog and stratus. In many of these instances, it is possible to observe the onset of drizzle at stations upstream and to extrapolate. Extrapolation may serve only to improve timing on arrival of conditions.

When extrapolating, remember the nature of the drizzle process. The drizzle area is likely to move or expand discontinuously since it is strongly dependent upon the lifetime of the cloud.

This has been limited to warm (above 0°C) and supercooled water clouds between –10°C and 0°C. At colder temperatures, the clouds are likely to have increasingly larger numbers of ice crystals and different physical cloud processes are occurring. Of course, when surface temperatures are equal or less than 0°C (32°F), forecast freezing drizzle.

B. MODEL GUIDANCE.

1. Model Output Statistics (MOS). MOS guidance is usually a reliable tool for forecasting precipitation since it considers climatology for your station. MOS bulletins provide probability of precipitation (POP), quantitative precipitation (QPF), probability of precipitation type (POPT), and probability of snow accumulation (POSA) forecasts. Use MOS guidance carefully during extreme weather events since climatology steers MOS guidance from forecasting rare or extreme events.

2. Trajectory Bulletins. Trajectory bulletins provide 24-hour forecasts for parcels of air in the lower atmosphere that are helpful in preparing detailed forecasts of the factors needed to forecast precipitation: temperature, dew point, and vertical motions. The trajectories trace the paths of parcels of air below 700 mb that are forecast to arrive in 24 hours. Use the trajectory data to prepare a forecast Skew-T. Note, however, that trajectory forecasts do not take into account local (e.g., diurnal, and air mass) changes in the air parcel's temperature and dew point.

C. DETERMINING PRECIPITATION TYPE.

1. Thickness. Thickness is the most common predictor for precipitation type. Thickness is the vertical distance between two constant-pressure surfaces. It is a function of temperature: the warmer the air, the thicker the layer. If the thickness of the layer is known, then something is known about its mean temperature. The most used 1000- to 500-mb thickness value for forecasting precipitation type is the 540 (5,400 meter) threshold. Another predictor is the 0°C 850-mb isotherm. A third predictor is

the 850- to 700-mb, 1,530 meter thickness line. Studies show snow is rare when the 850- to 700-mb thickness is greater than 1,550 meter, or the 1000- to 500-mb thickness is greater than 5,440 meters.

a. Analyzing/Extrapolating Patterns.

(1) Method 1. Figure 1-16 shows the 1000- to 500-mb thickness associated with an equal probability of precipitation being liquid or frozen (where the number in parentheses is the number of cases used to determine the equal probability value at that station). Figure 1-17 shows the probability of precipitation being liquid or frozen as the thickness increases or decreases from the thickness values given in Figure 1-16. For example, if the expected thickness for Fort Campbell, Ky., is 5340 meters, or 60 meters less than the thickness value of 5,400 meters shown on Figure 1-16, then Figure 1-17 indicates the probability of precipitation being frozen is greater than 80 percent. These figures are a good starting place for determining whether precipitation is liquid or frozen. Modify these whenever thickness values are not representative; for example, for lake effect and relatively thin layers of warm or cold air.

(2) Method 2. This method requires that both the low- and mid-level thickness be calculated and plotted, but the precipitation analysis is rapid and straightforward. Use forecast charts by looking at the isotherms, isodrosotherms, and thickness lines. Plot the following parameters, manually or by computer, on one map.

- The midlevel thickness (700-mb height minus the 850-mb height).
- The low-level thickness (850-mb height minus the 1000-mb height), specifically the thickness ridge line.
- The 700-mb contours.
- The 700-mb dew points.
- The 850-mb dew points.
- The surface 0°C (32°F) isotherm.
- The 850-mb 0°C (32°F) isotherm.

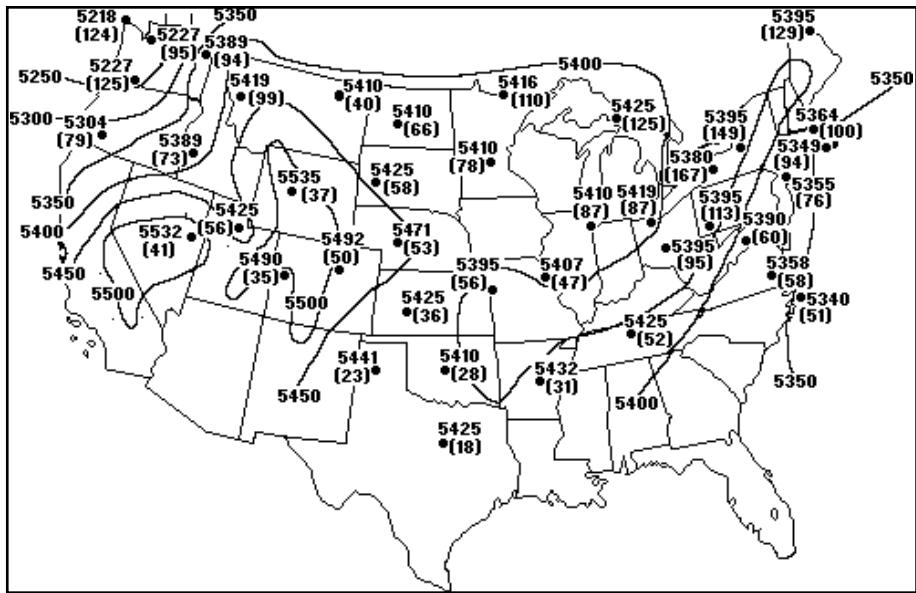

Figure 1-16. Equal Probability of Liquid or Frozen Precipitation. Based upon 1000- to 500-mb thickness (climatology).

Analyze the midlevel thickness for 1,520 and 1,540 meters and analyze for these dew points: -5°C (850 mb) and -10°C (700 mb). Forecast two or more inches of snow to occur in the area within these lines where precipitation is expected (see Figure 1-18). Analyze the midlevel thickness for the 1,555-meter line. Forecast freezing precipitation to occur in the area between this line and the 1,540-meter line and within the above dew-point lines, provided the surface temperature is below freezing. Find any areas of appropriate thickness but lacking sufficient moisture at either 850 mb or 700 mb. Be alert for any changes in the moisture pattern by advection or vertical motion. Expect only liquid precipitation on the warm side of the 850-mb 0°C (32°F) isotherm.

(3) *Method 3.* You will need to move analyzed thickness contours to their position at the valid time of your precipitation forecast. The following are general rules for extrapolating thickness patterns:

(a) *Low-level Thickness.* Choose several 1000- to 850-mb thickness lines that give a good estimate of the thickness pattern; e.g., the 1,300-, 1,340-, 1,380-meter lines. Move each line in the direction of the wind at 3,000 feet with 100 percent of that wind speed. The thickness ridge moves at the speed of the associated short wave. In a strongly baroclinic situation, it moves slightly to the left of the 500-mb flow at 50 percent of the wind speed. Since thickness patterns merely depict the large-

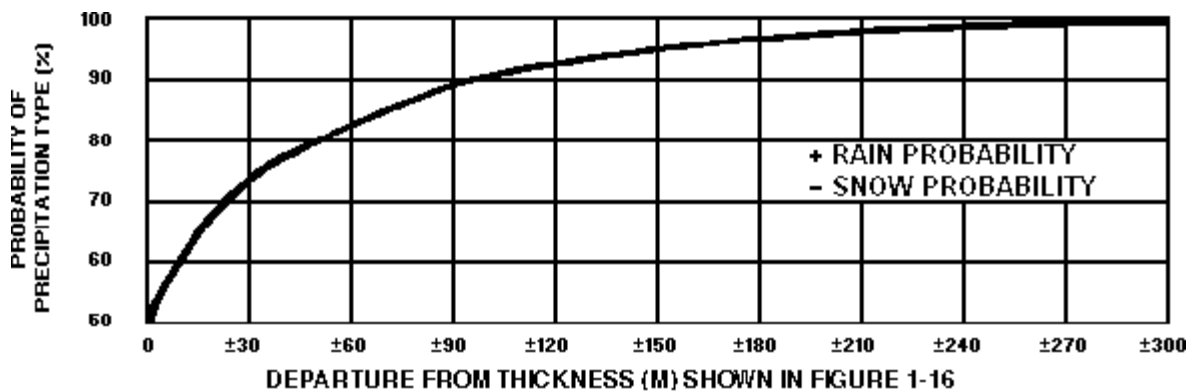

Figure 1-17. Probability of Precipitation being Frozen Versus Liquid.

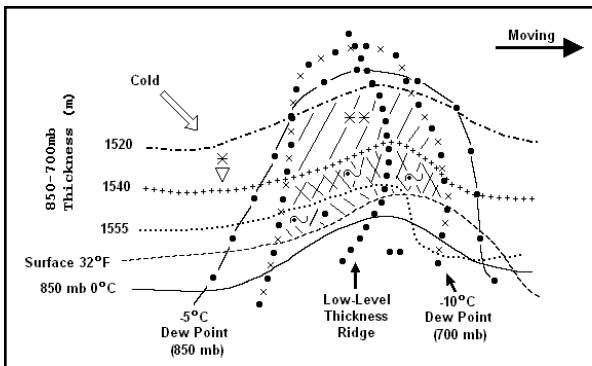

Figure 1-18. Method 2. Plotting indicated parameters on one map shows where to expect different precipitation types.

scale mass distribution, take care to adjust for rapid changes at 500 mb. Compare the thickness analysis with the surface analysis to ensure a reasonable forecast product.

(b) *Midlevel Thickness.* Move the 1,520- to 1,540-meter band at 100 percent of the 8,000-foot wind field. Consider continuity, the latest surface analysis, and other charts when developing a new thickness forecast chart.

Snowfall begins with the approach of a low-level thickness ridge after the passage of the 700-mb ridgeline or the line of no 12-hour temperature change (the zero isallotherm) and with the approach of the low-level thickness ridge. Snowfall usually ends after the passage of the low-level thickness ridge and the 700-mb trough. Snowfall is heaviest 1 to 2 hours before, and usually ends after the passage of the low-level thickness ridge and the 700-mb trough.

b. Regional Interpretations.

(1) *CONUS.* Table 1-10a lists typical thickness values used in the continental United States. Consider the values listed under “mixed” as 50 percent probability of either rain or snow. A value listed under “snow/rain” indicates precipitation is nearly all snow/rain for lower/higher values. Table 1-10b looks specifically at the 1000-500-mb thickness to determine precipitation type. Some of the parameters overlap because forecasting

freezing precipitation type is not always clear cut. Refer to station rules of thumb for local adaptations to this table.

Table 1-10a. CONUS thickness/precipitation thresholds.

Layer (mb)	Flurries	Snow	Mixed	Rain
850-500			4,050	
850-700		1,520	1,540	1,555
1000-500	5,240	5,360	5,400	5,490
1000-700		2,800	2,840	2,870
1000-850			1,300	1,325

Table 1-10b. 1000-500 mb CONUS thresholds.

1000-500-mb Thickness Value (m)	Type of Precipitation
> 5,400	Rain
< 5,435	Snow
5,385 - 5,435	Mixed Rain and Snow
5,330 - 5,410	Ice Pellets
5,330 - 5,520	Freezing Drizzle
5,330 - 5,440	Freezing Rain

(2) *Korea and Japan.* Table 1-11 lists common thresholds used in Korea and Japan to determine precipitation type.

(3) *UK and Northwestern Europe.* Table 1-12a considers terrain along with thickness values

Table 1-11. Thickness values for determining precipitation type for Korea and Japan.

Thickness (mb)	90% Chance Snow (m)	50% Chance Freezing Precipitation (m)	90% Chance Rain (m)
850-700	< 1,420	1,540	> 1,555
850-500	< 4,050	4,050	> 4,050
1000-850	< 1,300	1,300	> 1,325
1000-700	< 2,800	2,840	> 2,870
1000-500	< 5,340	5,400	> 5,490

Table 1-12a. Determining precipitation type in the UK and northwestern Europe using 1000- to 500-mb thickness values.

Area	Critical Value for Equal Probability of Rain and Snow (m)
Normal Terrain	5,270
Over established snowfields	5,360
At windward edges of snowfields	5,280
Over windward coasts	5,230

used in the UK and northwestern Europe, while Table 1-12b looks specifically at the 1000- to 700-mb thickness to determine precipitation types.

c. Nomograms. Nomograms are easy-to-use tools for forecasting precipitation type. Figure 1-19 uses thickness to predict solid or liquid precipitation. The Y-axis is the 850-700-mb thickness and X-axis is the 1000-850-mb thickness. Figures 1-20 and 1-21 were developed by the National Weather Service Central Region.

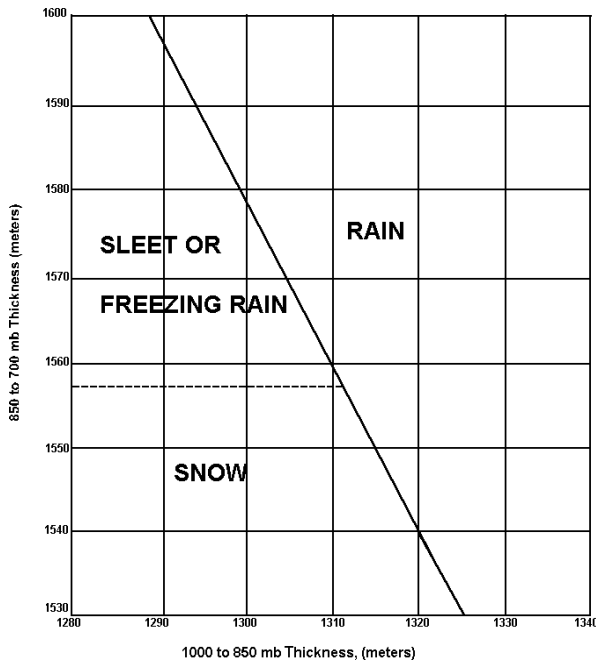

Figure 1-19. Determining Precipitation Type by Comparing Thickness. The figure compares 850- to 700-mb thickness to 1000- to 850-mb thickness.

2. Temperature.

a. Air Temperature. One study compared approximately 1000 surface observations of solid

Table 1-12b. Determining precipitation type in the UK and northwestern Europe using 1000- to 700-mb thickness values.

1000-700-mb Thickness (m)	Precipitation
> 2,850	Snow rare
2,820 - 2,850	Snow uncommon
2,780	Rain and snow equally probable; ice pellets likely
< 2,760	Rain rare

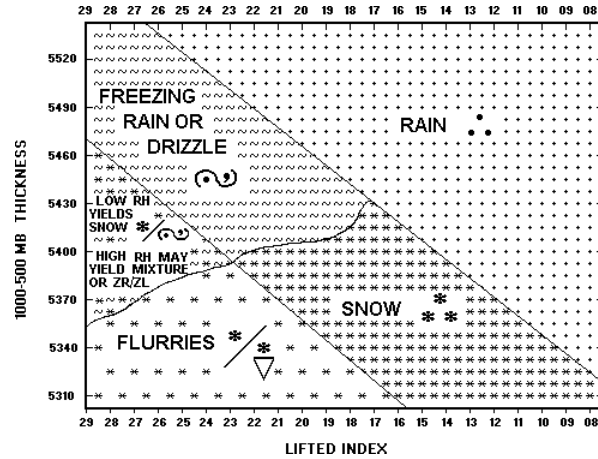

Figure 1-20. Precipitation-Type Nomogram. Precipitation type is based on lifted index and 1000- to 500-mb thickness (meters).

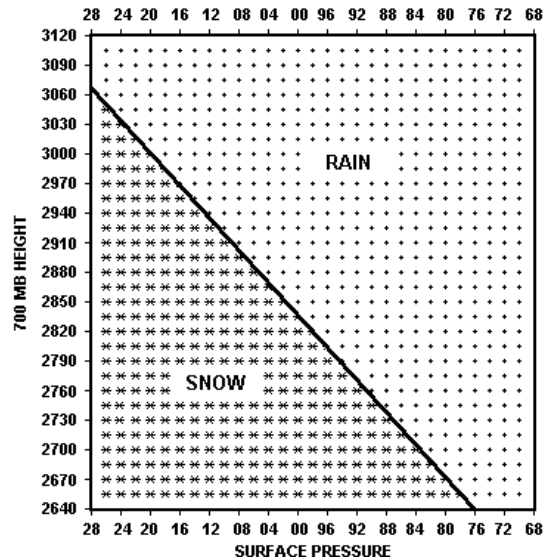

Figure 1-21. Precipitation-Type Nomogram. The figure uses 700-mb height and sea-level pressure to determine if rain or snow will occur.

or liquid precipitation with the corresponding surface temperature. The study concluded there is an equal chance (50 percent) of rain or snow occurring at surface temperatures of approximately 3°C (36.5°F). The average temperature for the occurrence of rain mixed with snow was also approximately 3°C (36.5°F). As temperatures decrease below 3°C (36.5°F) the probability of precipitation occurring as snow increased significantly. At 1°C (34°F) the probability of snow rose to 95 percent. On the other hand, as temperatures rise there was a decreasing probability of snow. At 6°C (42°F) there is only a 5 percent chance of snow. No snow was observed when temperatures equaled or exceeded 6°C (43°F). **Note:** This study did not incorporate reports of freezing rain or freezing drizzle.

Results compiled from various studies in different geographical areas are shown in Table 1-13. While surface temperature should not be used solely as a predictor of precipitation type (other thermodynamic parameters need to be considered as well), one study for the northeastern United States found 2°C (35°F) to be a critical value (predict snow at 2°C (35°F) and below, rain above 2°C (35°F)).

Table 1-13. Rain/Snow Thresholds

Level	Snow	Rain
Surface	≤ +0.7°C	> 2.2°C
Dew Point	≤ -3°C	≥ +3°C
850 mb	≤ 0°C (-2°C East-Coast US)	> 0°C
700 mb	≤ -6°C	> -6°C
500 mb: N of 40°N & mountains	≤ -30°C	
S of 40°N	≤ -20°C	

b. Wet-bulb Temperature. Techniques that use the 1000- and 850-mb wet-bulb temperature to determine precipitation types are often more effective than techniques that use temperature values alone. Wet-bulb temperatures are more conservative with respect to evaporation and condensation. Compute the wet-bulb temperatures directly from the temperature and dew point. The following technique is valid only east of the Rocky Mountains, at stations greater than 1000 mb.

Step 1. The technique uses three graphs (Figures 1-22 through 1-24). Use the first two graphs to quickly compute the wet-bulb temperatures on the 850- and 1000-mb surfaces. Enter the forecast air temperature and dew point and read the wet-bulb temperature in °C from the dashed lines.

Step 2. Determine precipitation type directly from Figure 1-24 by plotting the 850-mb wet-bulb temperature against the 1000-mb wet-bulb temperature.

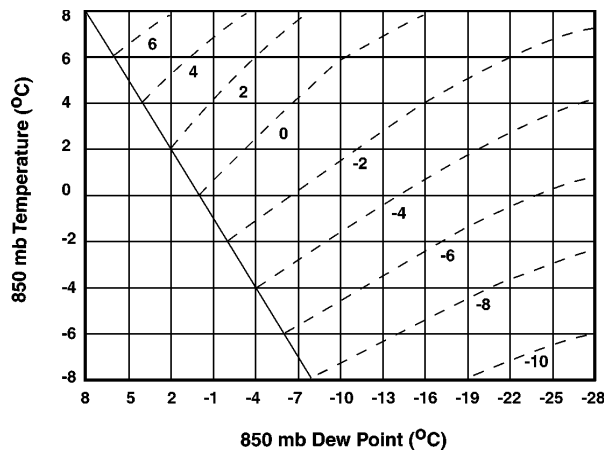

Figure 1-22. Computation of Wet-bulb Temperature at 850 mb. Use this figure to compute 850-mb wet-bulb temperature.

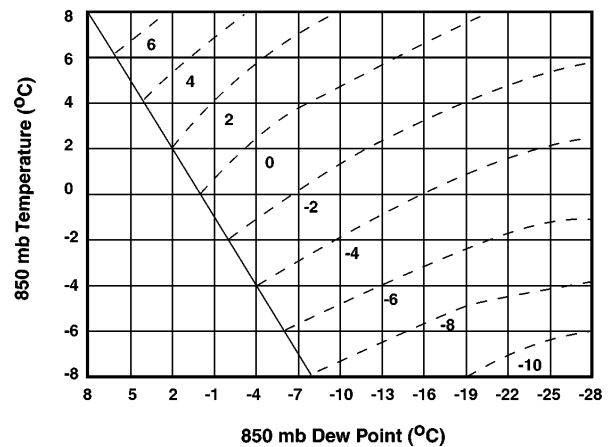

Figure 1-23. Computation of Wet-bulb Temperature at 1000 mb. Use this figure to compute 1000-mb wet-bulb temperature.

temperature and reading the type of precipitation from the graph. Use this technique in combination with other objective techniques to predict precipitation type.

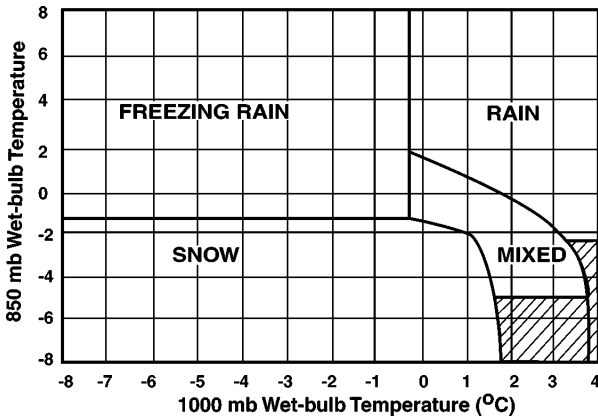

Figure 1-24. Expected Precipitation Type Based on Wet-bulb Temperatures. Derived from Figures 1-23 and 1-24. The striped area indicates no data.

c. Height of the Wet-bulb Freezing Level (UK and Northwestern Europe). Use the relationships shown in Table 1-14 to help forecast precipitation type based on the wet-bulb freezing level.

3. Models (NGM & Eta). Use the Nested Grid Model (NGM) or early Eta numerical bulletin to forecast the probability of the type of precipitation. The NGM T1, T3, and T5 temperatures roughly correspond to the 500-, 3,000-, and 7,000-foot levels above ground level and are ideal for determining the low-level temperatures necessary to forecast precipitation type.

Step 1. Determine the NGM or Eta T1, T3, and T5 temperatures for the period of interest from the bulletin.

Step 2. Locate the correct column across the top of Table 1-15 (left to right).

Step 3. Then find the corresponding T5 temperature on the left-hand margin.

Step 4. Read across to the correct column to find the corresponding probability of each type of precipitation.

Example: If T1 = 99, T3 = 00, and T5 = 03, then probability of Rain = 0.463 (46.3 percent), Snow = 0.370 (37.0 percent), and Mixed = 0.167 (16.7 percent).

4. Freezing Precipitation Indicators.

a. European Snow Index (ESI). This index accounts for evaporative cooling potential to determine precipitation type in continental Europe north of the Alps. It is the algebraic combination of surface temperature and the surface dew point in °C.

- The threshold for steady precipitation is 1 (less than or equal to 1 means snow; greater than 1 means rain).
- A value of 1 to 5 indicates mixed precipitation with rain possibly changing to snow.
- The threshold for showery precipitation is 3 (less than or equal to 3 means snow showers; greater than 3 means rain showers).
- Values of 3 to 7 indicate widespread mixed precipitation with the possibility of rain changing to snow.

Example. A temperature of 3°C with a dew point of -3°C would equal an ESI of 0. In this case, forecast steady snow.

Table 1-14. Height of the wet-bulb freezing level (UK and northwestern Europe).

Height of the Wet-bulb Freezing Level	Form of Precipitation
> 3,000 ft	Usually rain; snow rare.
2,000 - 3,000 ft	Mostly rain; snow unlikely.
1,000 - 2,000 ft	Rain can readily turn into snow.
< 1,000 ft	Mostly snow; only light or occasional precipitation falls as rain. Moderate or heavy precipitation may persist as rain near the windward coasts.

Table 1-15. T1, T3, and T5 values.

	T1 > 01	T1 = 01 or [T1 > 95 (-5) and T3 > 01]	[97 (-3) < T1 < 01 and T3 < 02] or 95 (-5) < T1 < 98 (- 2) and 97 (-3) < T3 < 02] or [89(-11) < T1 < 96(-4) and T3 > 97(-3)]	T1 < 90(-10) or [89(-11) < T1 < 98(-2) and T3 < 98(-2)]
T5	Rain Snow Mix	Rain Snow Mix	Rain Snow Mix	Rain Snow Mix
> 06	1.000 .000 .000	1.000 .000 .000	1.000 .000 .000	1.000 .000 .000
06	.981 .019 .000	.967 .032 .000	.750 .250 .000	.700 .300 .000
05	.977 .023 .000	.952 .048 .000	.727 .273 .000	.600 .400 .000
04	.975 .025 .000	.929 .071 .000	.500 .340 .160	.450 .500 .050
03	.973 .027 .000	.925 .075 .000	.463 .370 .167	.300 .600 .100
02	.968 .032 .000	.810 .095 .095	.409 .409 .182	.100 .700 .200
01	.871 .080 .049	.720 .160 .120	.361 .532 .107	.096 .793 .111
00	.861 .082 .057	.662 .200 .138	.317 .578 .105	.060 .877 .063
99	.650 .200 .150	.625 .214 .161	.258 .638 .104	.043 .922 .035
98	.607 .268 .125	.574 .295 .131	.183 .714 .103	.032 .936 .032
97	.556 .344 .100	.529 .353 .118	.168 .736 .096	.022 .948 .030
96	.521 .399 .080	.364 .545 .091	.136 .775 .089	.019 .954 .027
95	.500 .467 .033	.214 .714 .072	.113 .825 .062	.017 .961 .022
94	.450 .550 .000	.156 .783 .061	.000 .844 .056	.014 .967 .019
93	.333 .667 .000	.080 .866 .054	.071 .881 .048	.012 .971 .017
92	.200 .800 .000	.042 .925 .033	.033 .926 .041	.011 .989 .000
<92	.000 1.000 .000	.000 1.000 .000	.000 1.000 .000	.000 1.000 .000

b. Height of Freezing Level. Forecasters often use the freezing level to determine the type of precipitation (see Table 1-16). The forecast is based on the assumption that the freezing level must be lower than 1,200 feet above the surface for most of the precipitation reaching the ground to be snow. However, forecasters must understand the complex thermodynamic changes occurring in the low-levels to correctly forecast tricky winter precipitation situations. For example, the freezing level often lowers 500 to 1,000 feet during first 1.5 hours after precipitation begins, due to evaporation. When saturation occurs, evaporation ceases and freezing levels rise to their original heights within 3 hours. With

strong warm-air advection, the freezing level rises as much as a few thousand feet in a 6- to 8-hour period.

The following methods use the number of freezing levels to forecast the type of precipitation expected at the surface. Each one considers the change of state of precipitation from liquid-to-solid or solid-to-liquid as it falls through the atmosphere.

(1) *Single Freezing Level.* If the freezing level equals or exceeds 1,200 feet above ground level (AGL), forecast liquid precipitation. If the freezing level is less than or equal to 600 feet AGL, forecast solid precipitation. If the freezing level is between 600 and 1,200 feet AGL, forecast mixed precipitation.

(2) *Multiple Freezing Levels.* When there are multiple freezing levels, warm layers exist where the temperature is above freezing. The thickness of the warm and cold layers affects the precipitation type at the surface. If the warm layer is greater than 1,200 feet thick and the cold layer closest to the surface is less than or equal to 1,500 feet thick,

Table 1-16. Probability of snowfall as a function of the height of the freezing level.

Height of Freezing Level above Ground	Probability Precipitation will Fall as Snow
12 mb	90%
25 mb	70%
35 mb	50%
45 mb	30%
61 mb	10%

Chapter 1

forecast freezing rain. Conversely, if the warm layer is greater than 1,200 feet thick and the cold layer closest to the surface is greater than 1,500 feet thick, forecast ice pellets. Finally, if the warm layer is between 600 and 1,200 feet thick, forecast ice pellets regardless of the height of the lower freezing level.

(3) *Freezing Precipitation Checklist.* The freezing precipitation checklist (Table 1-17) has proven useful in Europe, especially for northern Europe. Do not forecast freezing precipitation unless all answers are **Yes**.

c. Checklist for Snow vs. Freezing Drizzle.

There are two types of atmospheric situations where freezing precipitation occurs. The most common case occurs when ice crystals melt as they fall through a sufficiently deep warm layer (temperature greater than 0°C). The water droplets hit a cold surface that has a temperature at or below freezing, and freeze on contact. The following technique is effective when the forecast decision involves the choice between snow vs. freezing drizzle. This technique is based on the precipitation nucleation process. It applies to the continental United States, Europe, and the Pacific regions. However, freezing precipitation is relatively rare in Korea. The checklist below assumes the atmosphere is below freezing through its entire depth, and the water droplets remain supercooled until surface contact.

- Does a lower-level moist layer (below 700 mb) extend upward to where temperatures are -15°C? If not, then freezing drizzle is possible.
- Is a midlevel dry layer (800 to 500 mb) present or forecast? If yes, freezing drizzle or a mixture of snow and freezing drizzle is possible.
- Is the midlevel dry layer (dew-point depression greater than or equal to 10°C) deeper

than 5,000 feet? If yes, the precipitation may change to freezing drizzle, or a prolonged period of mixed snow and freezing drizzle is possible.

- Is midlevel moisture increasing? If freezing drizzle is occurring and midlevel moisture is increasing, precipitation may change to all snow.

- Is elevated convection occurring or forecast to occur? If yes, the midlevel dry layer may be eroded, causing snow instead of freezing drizzle.

D. FORECASTING RAINFALL AMOUNTS.

1. Quantitative Method. The following method can help forecast the amount of rainfall to the nearest 1/4 inch. It is valid for the central United States. Simply follow the directions based on the period of the forecast and the geographical location of the 850-mb trough relative to the 100°W longitude. Note: The following methods must be adjusted for terrain.

a. 850-mb Trough is West of 100°W Longitude.

(1) 0- to 12-hour Forecast.

Step 1. On a local area work chart, determine the area where you expect precipitation to occur in the next 12 hours. Plot the location of the forecast 850- and 700-mb trough axes.

Step 2. Draw a line showing the maximum 850-mb warm-air advection through the forecast precipitation area.

Step 3. Find the 850-mb dew point at the point where the line drawn in Step 2 first intersects the area outlined in Step 1.

Table 1-17. Freezing precipitation checklist for Europe. If any answer is “No,” do not forecast freezing precipitation.

Surface temperature less than or equal to 0°C for at least 12 hours?	Yes	No
850-mb temperature greater than or equal to 4°C?	Yes	No
Warmest temperature aloft is greater than or equal to 0°C?	Yes	No
1000-850-mb thickness in between 1,280 and 1,320 meters?	Yes	No
1000-500-mb thickness in between 5,350 and 5,450 meters?	Yes	No

Step 4. Measure the surface dew point (°C) directly below the 850-mb dew point.

Step 5. Add the 850-mb dew point temperature to the surface dew-point temperature (°C).

Step 6. Measure the distance in nautical miles from the 700-mb trough line to the center of the forecast precipitation area.

Step 7. Enter the values obtained from Steps 5 and 6 into Figure 1-25a. The graph gives the expected maximum precipitation accumulation during the next 12-hour period.

(2) 12- to 24-hour forecast:

Step 1. Determine the area where precipitation is expected to occur in the 12- to 24-hour forecast period.

Step 2. Draw a line showing the maximum 850-mb warm-air advection through the forecast precipitation area.

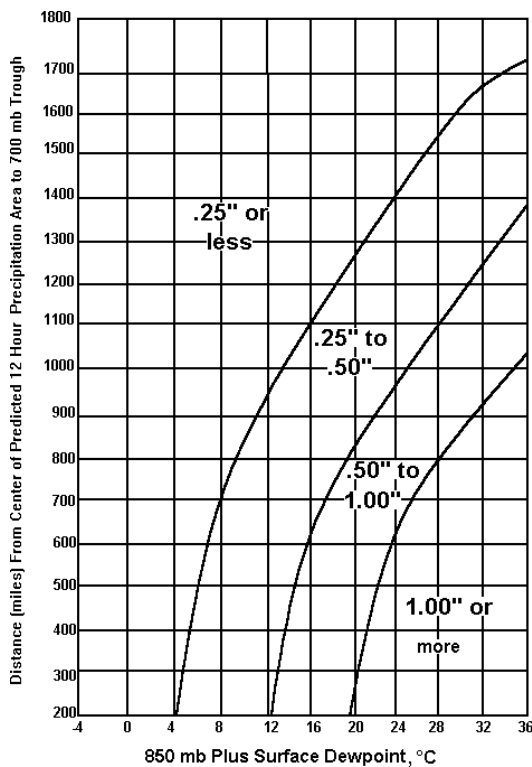

Figure 1-25a. Maximum Precipitation when the 850-mb Trough is West of the 100° Meridian. Figure shows 0- to 12-hour maximum precipitation.

Step 3. Find the 850-mb dew point at the point where the line drawn in Step 2 intersects the area outlined in Step 1.

Step 4. Measure the surface dew point (°C) directly below where you obtained the 850-mb dew point.

Step 5. Add the 850-mb dew point to the surface dew point (°C).

Step 6. Measure the distance in nautical miles from the 700-mb trough line to the center of the forecast precipitation area.

Step 7. Enter the values obtained from Steps 5 and 6 into Figure 1-25b. The graph gives the expected precipitation accumulation during the 12- to 24-hour period.

b. 850-mb Trough is East of 100°W Longitude.

(1) 0- to 12-hour forecast.

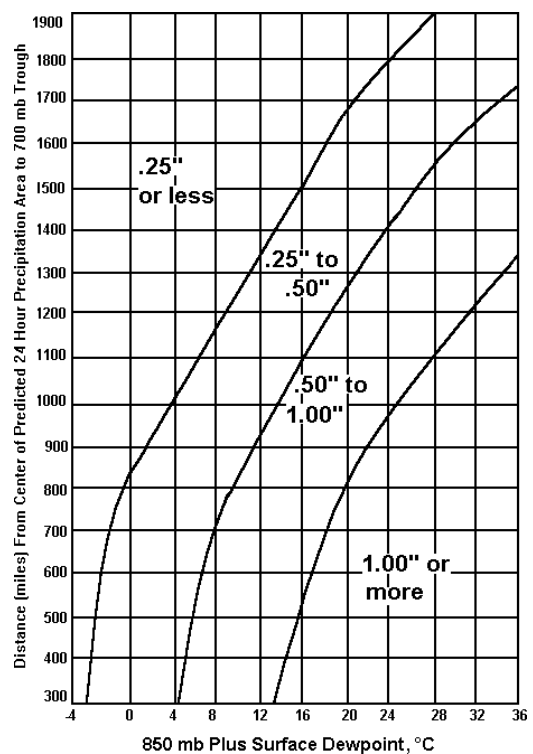

Figure 1-25b. Maximum Precipitation when the 850-mb Trough is West of the 100° Meridian. Figure shows 12- to 24-hour maximum precipitation.

Chapter 1

Step 1. Determine the area where precipitation is expected to occur (next 12 hours).

Step 2. Draw a line indicating the maximum 850-mb warm-air advection through the forecast precipitation area.

Step 3. Find the 850-mb dew point at the point where the line drawn in Step 2 intersects the area outlined in Step 1.

Step 4. Measure the surface dew point (°C) directly below the 850-mb dew point.

Step 5. Measure the difference in surface pressure (mb) between the point where the line indicating the maximum 850-mb warm-air advection first intersects the forecast precipitation area to the point where it exits the forecast precipitation area.

Step 6. Add the 850-mb dew point to the surface dew point (°C).

Step 7. Enter the values obtained from the steps 5 and 6 into Figure 1-26a. The graph gives the expected precipitation accumulation during the next 12-hour period.

(2) 12- to 24-hour forecast.

Step 1. Outline the forecast precipitation area expected for the 12- to 24- hour forecast period.

Step 2. Measure the maximum 850-mb warm-air advection (°C) through the forecast precipitation area.

Step 3. Measure the maximum 850-mb cold-air advection (°C) into the precipitation area.

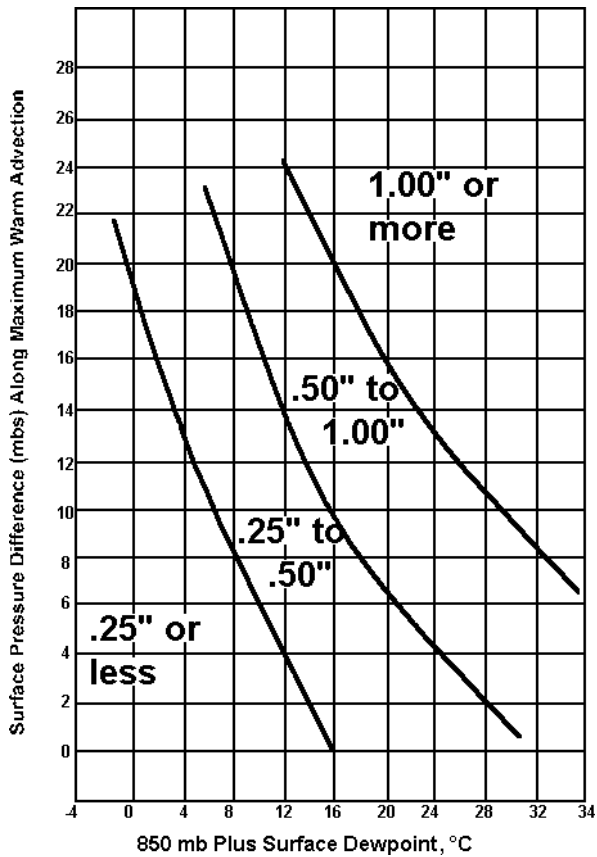

Figure 1-26a. Maximum Precipitation, 850 mb Trough East of 100° Meridian. Figure shows 0- to 12-hour maximum precipitation.

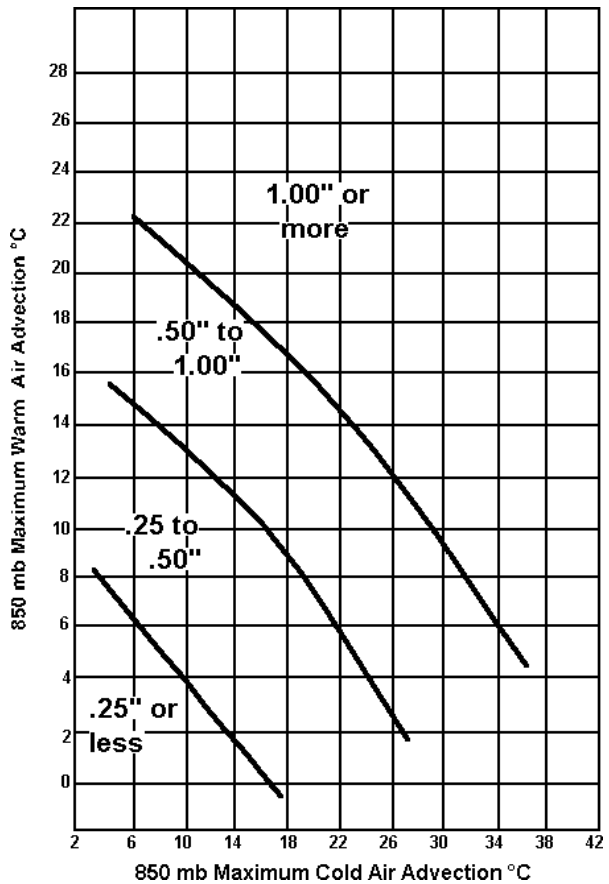

Figure 1-26b. Maximum Precipitation, 850 mb Trough East of 100° Meridian. Figure shows 12- to 24-hour maximum precipitation.

Step 4. Enter the values obtained into Figure 1-26b. This gives the expected precipitation amount for the next 12- to 24-hour period when the 850-mb trough is east of the 100°W longitude.

2. Heavy Rainfall

a. Radar Signatures Associated with Flash Floods. Monitoring weather radar is the best way to detect the potential for heavy rains and flooding. Pay particular attention to the signatures below:

- Rapidly growing echoes.
- Slow-moving echoes.
- Persistency (long lasting).
- Train echoes (echoes that move repeatedly over the same area).
- Hurricanes and tropical storms.
- Lines.
- Line Echo Wave Patterns (LEWPs).
- Converging echoes and lines.

b. Satellite Signatures. Satellite imagery is a valuable tool to use in evaluating heavy rainfall potential. Consider forecasting heavy rains with if any of the following parameters or signatures occur:

- Quasi-stationary thunderstorm systems, those that regenerate, and those that move over the same area.
- Rapid horizontal expansion of the anvils. Infrared (IR) imagery picks this up best.
- Rapid vertical growth.
- IR tops colder than –62°C.
- Overshooting tops.
- Merging of convective cloud lines and thunderstorms.
- Mesoscale Convective Complexes (MCCs).
- Rapid clearing to the rear of thunderstorms associated with sinking air. This is an indicator of strong vertical circulation and suggests heavy convective precipitation.
- Thunderstorm anvils that stretch out in a thin narrow band parallel to the upper-level wind flow, new thunderstorms often develop upwind.

c. Excessive Rainfall Checklist for the East Central United States. Table 1-18 identifies most of the meteorological conditions associated with flooding over the east-central portion of the United States. The Weather Service Forecast Office in Philadelphia developed this checklist.

Table 1-18. Excessive rainfall checklist for the east central United States.

1. Is there existing (or forecast to be) an active boundary or convergence zone in the forecast area?
2. Does the hodograph have high directional shear and low speed shear with veering in the lowest 8,000 ft, and winds equal to or less than 25 knots above (ignore winds below) a radiational inversion?
3. Is the 1000- to 500-mb thickness within or exceeding the local parameter for heavy rain?
4. Is the precipitable water 50 percent above normal (150 percent of normal) or greater for the time of year?
5. Have rain amounts of more than 1 inch in 12 hours or more than 2 inches in 24 hours occurred the day(s) before, in an area equal to or less than 350 miles from the forecast area in the flow pattern?
6. Is the air mass considered tropical (i.e., dew points higher than 68°F) with warm top precipitation occurring or expected to occur or is deep convection anticipated through the tropopause with cold top precipitation?

E. SNOWFALL.

1. General Guidance. The following rules are empirical in nature:

- The average relative humidity for the layer from the surface to 500 mb must be at least 70 to 80 percent in order to have significant synoptic-scale precipitation.
- Snowfalls greater than 2 inches are associated with warm advection and positive vorticity advection, assuming adequate moisture is available (except for lake and orographic effects).
- Most precipitation occurs within the 65 percent (or higher) relative humidity areas on model forecast charts. Similarly, most heavy precipitation occurs within the 80 percent relative humidity area.
- The 850-mb -5°C isotherm usually bisects the area that receives heavy snow accumulation during the subsequent 12 hours.
- Heavy snow occurs in the area north of the 850-mb 0°C isotherm and south of the 850-mb -5°C dew-point line or the 700-mb -10°C dew-point line.

- Beginning and Ending Times. Snow begins as the 700-mb ridgeline passes overhead. Snow ends at the 700-mb trough line (and in some cases, at the 500-mb trough line). Heavy precipitation tends to begin as the 500-mb ridgeline passes overhead and ends as the contour inflection point passes overhead.

2. Estimating Rates/Accumulation

a. Using Weather and Visibility. Visibility measurements can be used to estimate snowfall rates and average snow accumulations (see Table 1-19).

Table 1-19. Accumulation rates of snowfall as a function of visibility.

Average Accumulation	Weather (snowfall rate)	Visibility
0.2 inches/hour	Light	> 5/8 mile
1 to 1.2 inches/hour	Moderate	5/16 to 5/8 mile
1.6 inches/hour	Heavy	< 5/16 mile

Note: Strong surface winds may contribute to restricted visibility due to blowing snow.

b. Snow Index Using 200-mb Warm Advection.

This method is effective when used between 10 October and 10 March. It uses warm-air advection at 200 mb moving into an area of cold air to forecast the snowfall amounts for the next 24 hours. Warm-air advection at 200 mb is the key indicator because the 200-mb warm pocket usually coincides with the 500-mb vorticity maximum, particularly in well-developed systems. Thus, warm-air advection at 200 mb is a way to measure weather system strength.

Warm air normally occurs in 200-mb troughs and cold air in the ridges. Temperatures are usually -40° to -45°C in strong troughs and are -65°C or colder in strong ridges. Temperatures typically remain in the -50°C range with weaker systems. Generally at 200 mb, the direction of movement of the 500-mb vorticity maximum is parallel to a line connecting the 200-mb warm and cold pockets—except in the case of large-scale cyclonic flow over North America associated with rapidly moving short waves, or cutoff lows in the southwest United States that have remained nearly stationary for the previous 24 hours. If the storm is not well developed vertically (i.e., weak 200-mb temperature contrasts), heavy snow usually does not occur. If dynamics are strong, moisture usually advects into the storm.

- When there is warm-air advection at 700 mb into a snow threat area, the total average snow accumulation for the next 24 hours (providing the column of air is cold enough for snow) is given, in inches, by the following: determine the amount of warm air advection at 200 mb by taking the difference (°C) between the warm core in the trough and the cold core in the ridge area; then divide by 2, ignoring the units. If the indicated warm air advection extends less than 6° latitude (360 nm) upstream from the forecast area, the precipitation is usually of short duration. See Figure 1-27 for an example.

- If there is cold-air advection at 700 mb into the snow threat area (or if it's observed within 8° of latitude (480 nm) of the forecast area at 700 mb), the total snow accumulation is estimated by dividing the amount of warm-air advection at 200 mb by 4.

- The maximum snowfall occurs near the coldest 200-mb temperature found downstream from the warmest 200-mb temperature.

Chapter 1

difference between snow and no snow at a specific location. This shifting is most common when the wind core at 3,000 feet is less than 25 knots. When the wind speed core at 3,000 feet is greater than 25 knots, directional shifts are less frequent, and if they occur, they are usually less than 15 degrees.

By using the techniques and information provided above, forecast lead times can improve for snow showers. Once snow begins, use the radar to look for openings or shifts in the orientation of the bands to forecast when the snow tapers off or ends. These openings and shifts may indicate temporary breaks. If they are upstream, determine whether there is a solid band or a series of snow shower cells. A solid band does not change the observed condition, but a cellular pattern indicates an intermittent condition with periods of heavier snow and reduced visibility.

Use the LAWC to forecast when the snow ends. When a diffluent wind pattern arrives at the station,

clearing is likely. Examine the surface wind pattern upstream for a diffluent wind pattern, and advect the pattern at the same rate the snow moved.

4. Lake Effect Snow. Lake effect snowstorms occur during the late fall and winter when cyclonically curving cold air crosses warmer lake waters and creates localized areas of instability. Lake effect snowstorms are experienced a few hundred miles downstream in persistent weather systems. The checklist in Table 1-20 provides a list of weighted parameters that determine one of three possible forecast choices: snow, snow alert, or no snow.

Total the score. Greater than 40 points, forecast snow. If the score is greater than zero but less than 40, snow is possible. This indicates there is a potential for lake effect snow but conditions are marginal. Do not forecast any snow with a total of less than zero.

Table 1-20. Lake effect snowstorm checklist. If total score is less than 0, don't forecast snow; 0 to 40 snow is possible; greater than 40 forecast snow.

Lake Effect Snow Checklist/Score Sheet			Score
Step 1.	Vorticity greater than 18 crossing lake	(+20)	
Step 2.	If no, vorticity 12 to 18 crossing lake	(+10)	
Step 3.	Vorticity maximum crosses lake directly	(+10)	
Step 4.	Cyclonic curvature (surface to 500 mb)	(+5)	
Step 5.	If anticyclonic curvature at surface and cyclonic curvature aloft, go to Step 8.		
Step 6.	Anticyclonic curvature aloft	(-10)	
Step 7.	Anticyclonic curvature at surface	(-10)	
Step 8.	Inversions: NGM temperatures:		
	T5 – T3 greater than 3°	(-10)	
	T5 – T3 greater than 1°	(-5)	
Step 9.	Temperature (lake) minus temperature (850 mb) less than 10°C	(-35)	
	Temperature (lake) minus temperature (850 mb) greater than 10°C and less than 13°C	(0)	
Step 10.	Instability:		
	Conditional	(+10)	
	Moderate	(+20)	
	Extreme	(+30)	
Step 11.	850-mb/boundary layer wind: 0° to 210°	(-35)	
	850-mb/boundary layer wind: 340° to 020° or 220° to 230°	(0)	
	850-mb/boundary layer wind: 240° to 0°	(+20)	
Total			

5. **Heavy Snow.** Generally, forecast heavy snow if all of the following conditions are met:

- 850-mb dew point between -5° to 0°C .
- 700-mb dew point warmer than -10°C .
- 500-mb temperature North of 40°N less than or equal to -35°C ; South of 40°N less than or equal to -25°C .

Additionally, the following guidance may help in forecasting heavy snow occurrences.

a. **Non-convective snowfall.** Table 1-21 lists rules of thumb by criteria for forecasting snowfall during non-convective situations.

b. **Locating Areas of Maximum 12-hour Snowfall.** Perform the following analysis to pinpoint the areas of heavy snowfall. Maximum snowfall occurs where these areas intersect the most.

- Outline the surface 0°C (32°F) isotherm and 0°C (32°F) dew points.

- At 850 mb, outline areas having dew points $\leq 4^{\circ}\text{C}$ and moisture.

- At 700 mb, outline areas having dew points $\leq 10^{\circ}\text{C}$ and moisture. Also, locate areas showing the greatest 12-hour cold advection.

- At 500 mb, locate the jet (-20°C isotherm) and cold thermal troughs.

- Outline areas of 80 percent relative humidity (RH) from surface to 500 mb.

- Outline areas of positive vorticity advection (PVA) and 12-hour forecast position.

- Perform a low-level thickness analysis (850-700-mb thickness). A 1,520 to 1,540 meter band about 120 miles wide, is a good first approximation of the heavy snowfall zone. Width is seldom greater than 200 miles and the axis of heaviest fall is 2 to 4 degrees of latitude on the cold side of the surface low.

Table 1-21. Rules of thumb for forecasting heavy non-convective snowfall.

850 mb and Surface Analysis	The 0°C isotherm at the surface moves little when steady precipitation is occurring and the 850-mb level is saturated. Heaviest snowfall occurs in moist air, with dew points between -4° and 0°C , northwest of the surface low.
700 mb	The heaviest snow occurs along the track of a closed low at 700 mb. Snow ends with trough passage. Heaviest snow also occurs in moist air with the 700-mb dew point in the range of -10° to -5°C . Heavy snow is also possible where warm anticyclonic wind flow converges with colder northwest flow. On the surface product, this surface convergent region is also favored for freezing drizzle on the northwest side of a polar high. It is important to locate the center of the strongest 12-hour cooling and its movement. The area into which this cold advection moves is also a likely area for heavy precipitation.
500 mb	When trough temperatures are -20°C or colder, heavy snow occurs approximately 400 to 800 NM downstream from the trough axis.
Precipitable Water Index (PWI)	A simple conversion for potential 12-hour snowfall is to multiply the PWI by 10.
Average Relative Humidity	Average relative humidity from surface to 500 mb should be 80 percent or greater.
Low-level Thickness	1000- to 850-mb thickness, 1,300 meters or less. 850- to 700-mb thickness, 1,555 meters or less.

c. Satellite Techniques. Two satellite imagery interpretation techniques are useful in pinpointing heavy snow areas. The first technique uses the southern edge of the coldest cloud tops in satellite imagery to approximate the southern boundary of the heavy snow band. A line drawn through the center of the coldest tops approximates the northern boundary of the most significant snowfall. The second technique focuses on the midpoint of the enhanced cloud band. Extrapolate the cloud midpoints downstream.

Note: The heaviest snow usually does not occur where the infrared temperatures are the coldest.

(1) The Shear Zone Interpretation Technique. The southern edge of the coldest cloud tops, often the location of the heaviest snowfall, typically develops just to the left of, and parallel to, cyclonic shear zones. A shear zone is a narrow region where there is an abrupt change in the horizontal wind component.

- To forecast the shear zone location, visualize a line from the vorticity maximum to just left of the downstream bulge in the dry slot. A line extended eastward or downstream through the cold cloud tops approximates the cyclonic shear zone.

- The leading edge of maximum wind speeds associated with the jet is near the furthest downstream extension of the dry slot.

- A vorticity maximum is located in the area of the greatest speed shear. Locate the vorticity maximum near the upstream edge of the enhanced clouds.

- The southern edge of the clouds and the southern edge of the attendant heavy snow band should develop about 1 degree of latitude (60 NM) left looking downstream of the shear zone.

(2) Shear Zone Heavy Snow Events. A common feature of snow events occurring with weaker storms is a pronounced cyclonic speed shear zone aloft. This type of situation also exhibits three other important characteristics.

- Cloud and precipitation development are usually very rapid and forecast lead time is minimal.

- The weather associated with the shear zone often turns out to be the *main event*, although most tend to focus most on the developing storm lifting out with the upper trough.

- The heaviest snow of the event generally occurs where the PVA and warm-air advection act together or in succession.

This first method is most reliable when there is a long and narrow dry slot, which may be the result of a sharper shear zone in this area. Significant snowfall is still possible until the vorticity maximum passes. Use extrapolation of arrival of the back edge of clouds to approximate the time when the snow tapers off.

d. Favorable Synoptic Patterns. Analyzing the synoptic situation can help identify areas most likely to receive heavy snow. See Tables 1-22 and 1-23.

Table 1-22. Location of heaviest snow relative to various synoptic features.

Feature	Downstream Distance	Area Lateral Distance
500-mb vorticity maximum	6.5 to 7 degrees	2.5 degrees to the left of path
Surface low-pressure center	5 degrees	2.5 degrees to the left of path
500-mb low center	1 degree downstream from inflection point	Along track
1000-500-mb thickness	Along thickness ridge	Between 5,310 and 5,370 m
700-mb low center		Along track
500-mb 12 hr height fall		Left of track
Intersection of 850-mb and 500-mb maximum wind axes		Along track
850-mb low center	3 to 12 degrees	1 to 4 degrees to the left

Table 1-23. Synoptic snowstorm types.

Deep Occluding Low	The track of the low is to the north-northeast and its speed slows from an initial 25 knots to only 5 to 10 knots during the occluding process. In practically all cases a closed low exists at 500 mb and captures the surface low. The area of maximum snowfall lies from the north to west of the center with rates of 1/2 to 1 inch per hour. The west edge of the maximum area is at the 700-mb trough of low center and all snow ends with the passage of the 500-mb trough or low center.
Non-Occluding Low	The track of the low is to the northeast or east-northeast at 25 knots or more. It is associated with a fast moving open trough (occasionally with a minor closed center) at 500 mb. The maximum area is located parallel to the warm front from north to northeast of the storm center. Duration is short (4 to 8 hours).
Post-Cold Frontal Type	A sharp cold front oriented nearly north-south in a deep trough. A minor wave may form on the front and travel rapidly north along it. The troughs at 700 mb and 500 mb are sharp and displaced to the west of the front by 200 to 300 NM. Ample moisture is available at 850 mb and 700 mb. The area of maximum snowfall is located between the 850- and 700-mb troughs. The snowfall duration is 2 to 4 hours.
Warm Advection Type	Occurs infrequently. The lack of an active low near the maximum snowfall area makes it different from the others. A high-pressure ridge or wedge is situated north of a nearly stationary warm front. The area of maximum snowfall is in a band parallel to the front.
Inverted Trough Snowstorm	This consists of an inverted trough extending northward from a closed low-pressure system to the south. It may be just an inverted trough at the surface. The available moisture determines the extent of the snowfall area. Snowfall ends with the passage of the 700-mb trough. Heavy snow may occur when the flow at 500 mb is nearly parallel to the surface trough. The surface and 700-mb troughs move very slowly when this occurs.

e. Jet Stream Snow Bursts. Consider three necessary and interrelated parameters when using this technique:

- The area should be to the south of the 300-mb jet on the anticyclonic shear side. Strong diffluence in the wind field on the trailing side of the jet induces low-level convergence.

- Strong warm advection at 850 mb must be present. The area of concern is between the 0° and -10°C isotherms. If the air is above freezing at 850 mb, the air must be dry.

- Weak positive vorticity advection should be occurring. Vorticity values generally range from 8 to 12 with a center no higher than 14.

Note: Vorticity units are measured in radians per second. Typical orders of magnitude are 10⁻⁵.

The maximum for heavy snow occurs at the intersection of the strongest 850-mb advection between 0° and -5°C, the strongest PVA (but vorticity values of less than 14), and a diffluent zone associated with the anticyclonic shear side of the 300-mb jet. This event occurs in a small vertical

Chapter 1

layer between 800 mb and 500 mb. The average relative humidity of this layer is 60 or 70 percent.

6. Regional Guidance.

a. Central Japan. Forecast snow for the Kanto Plain when:

- The 1000- to 500-mb thickness is 5,400 meters or less.
- The surface temperature is predicted to be 3°C (37°F) or less when precipitation begins.
- Clear evidence exists of cold advection at the 925-, 850-, 700-, or 500-mb levels.
- The 850-mb temperature is -3°C or colder.
- The freezing level is 2,100 feet or less.
- Low-level winds (1,000 and 2,000 feet) are northeasterly.

b. UK and Germany. If located in hilly or mountainous terrain, determine both the elevation and detailed location. Obviously the higher the elevation, the more snow expected. Temperatures are generally lower on northern slopes due to reduced solar insolation.

- If unstable cold air is entering Germany and the UK after a warm spell, snow falls if the 850-mb temperature is less than or equal to -6°C or the 1000-500-mb thickness is less than or equal to 5,260 meters.

- If warmer air is entering Germany and the UK after a cold spell, snow can fall if the 850-mb temperature is less than or equal to -2°C or the 1000-500-mb thickness is less than or equal to 5,380 meters.

Note: These rules of thumb do not work with Gulf of Genoa Lows.

c. Korea. Heavy snow events in the northwest and interior sections of Korea are uncommon. Therefore, forecasters in Korea, especially new ones, tend to over-forecast snow amounts. However, heavy snow events are quite possible in the southwest

(especially near Kunsan AB) and northeast due to on-shore flow situations. In fact, very heavy snow events (4 to 6 inches) occur on the northeast coast of Korea near Kang Nung and Sokcho when low-pressure systems stall or rapidly develop off the east coast of Korea and strong southeasterly onshore flow is firmly established.

(1) Forecast aids for instability snow showers at Kunsan AB:

- 850-mb flow cyclonic or neutral?
- Sea surface temperature minus 850-mb temperature value greater than 17°C?
- 850-mb wind direction 250° to 340°? (280° to 320° is ideal).
- 850-mb wind speed greater than 19 knots?
- 850-mb temperature less than 8°C (November, December, March).
- 1000-500-mb thickness. Less than 5,280 meters for all snow, between 5,280 and 5,320 meters for mixed, greater than 5,320 meters for all rain.
- Freezing Level. Less than 1,200 feet for all snow, between 1,200 and 1,600 feet for mixed, greater than 1,600 feet for all rain.

Note: If the above apply, forecast instability snow showers.

- Sea Surface Temperature minus 850-mb temperature greater than 20°C?
- Southern low over Republic of Korea in advance of cold front?

Note: If the two above apply, forecast heavy snow showers.

(2) Lake Effect Snow at Kunsan AB, Korea. Lake effect is generally considered a snow-producing regime. However, early and late in the season, rain showers occur. Ideally, a low-pressure system is east of the base. Cyclonic flow produces a fetch that causes showers to advect inland.

- Forms when the sea surface water temperature is at least 17°C warmer than the air mass above it. (Salinity may account for the lower temperature spread of 13°C needed in the US and Canada). Calculate this by subtracting the 850-mb temperature from the SST. When the temperature difference is 20°C or more, heavy snow is likely.

- Convergence or lift must be present. Lake effect forms when there is cyclonic circulation on the surface and at 850 mb, or when there is anticyclonic circulation on the surface and cyclonic circulation at 850 mb. It does not generally form when there is anticyclonic circulation at 850 mb regardless of what is happening on the surface. However, neutral flow at either level is still capable of supporting the process.

- The fetch, or winds exposed to the lake surface, is important in determining where the downwind end of the instability showers reach. The fetch follows the gradient winds and must be at least 20 knots to keep the convective process alive.

- In November and December, there are surface to 500 mb thickness thresholds to predict snow versus rain for lake effect events: less than 5,280 meters for all snow, 5,280 to 5,320 meters for mixed, above 5,320 meters for all rain. In January, use: less than 5,320 meters for all snow, 5,320 meters to 5,360 meters for mixed, and above 5,360 for all rain.

Note: The more northerly the 850-mb flow, the greater the rain/snow thickness threshold may be.

- If the freezing level is less than 1,200 feet expect all snow, 1,200 to 1,600 feet expect mixed precipitation, above 1,600 feet expect all rain.

- During periods of enhanced convection, the freezing level may drop, temporarily changing rains showers to snow showers until the stronger convection ends.

d. Northeastern US. Intense storm systems may affect the northeastern United States any time of the year; however, they are more frequent and violent during the winter season. These intense storm systems (called Nor'easters) are often

accompanied by heavy snowfalls. These systems develop along frontal boundaries south of 40°N and east of the Appalachian Mountains, usually near the coast. They move northward to northeastward and reach maximum strength near New England. Usually, storm development begins as frontal systems approach the southeast United States from the west and/or southwest. Frequently, fronts moving across the Southwest become so weak that they are not detectable from surface data alone, and they often are dropped from the surface analysis. Surface frontal features would likely include a stationary polar front lying east-west across the South and/or Gulf of Mexico as shown in Figure 1-28a. A deep upper trough can trigger cyclogenesis near the stationary polar front, and explosive cyclogenesis occurs when warm, moist air from the Gulf Stream is entrained in the developing cyclone. The following synopsis shows such a development of a Nor'easter along a polar front:

In Figure 1-28a, high pressure dominates nearly all of the United States. Inverted troughs appear over the Appalachians and the Rockies. A weak mP frontal system, which entered the Pacific Northwest 3 days earlier, weakened over the strong high-pressure ridge. Snow development over the western Plains and southern Rockies likely reflects both an upslope flow and the approaching short wave.

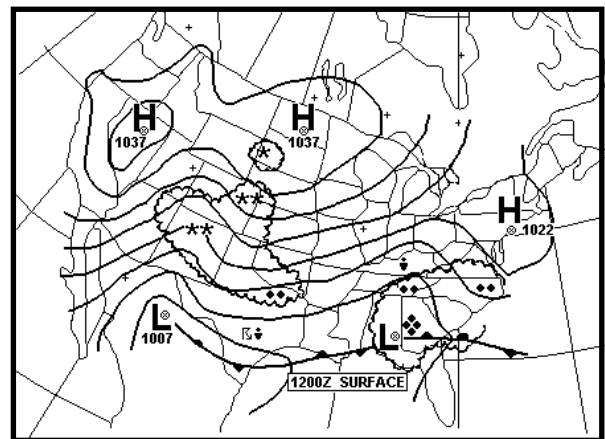

Figure 1-28a. A 1200Z Surface Pattern. A stationary polar front lying east-west across the South and/or Gulf of Mexico

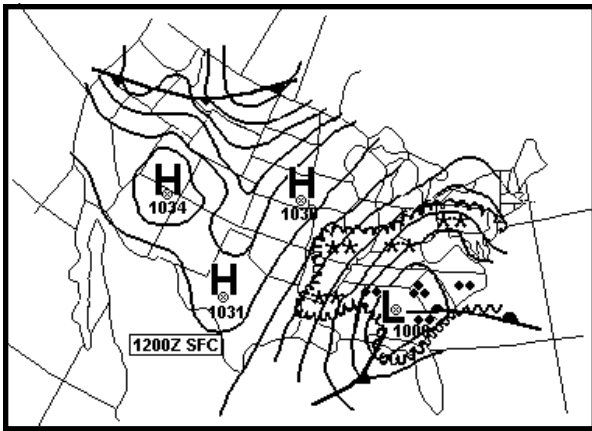

Figure 1-28b. Surface Pattern 24 Hours Later. The surface low has organized and deepened.

In Figure 1-28b, the surface low has organized and deepened with the approach of the upper trough. The precipitation area has increased over the Ohio Valley and East Coast areas. Explosive cyclonic development is expected when the low-pressure system moves further to the east and taps into the warm waters of the Gulf Stream.

In Figure 1-29a, the upper-level pattern was a long-wave trough oriented northeast-southwest across the

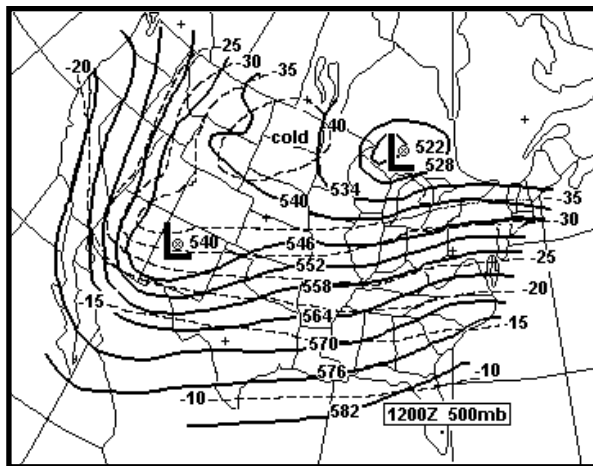

Figure 1-29a. The 1200Z 500-mb Pattern. The upper-level pattern consists of a long-wave trough oriented northeast-southwest across the eastern and central continental United States. This chart is valid at the same time as Figure 1-29a.

eastern and central continental United States. A weak short wave, which had developed over the Gulf of Alaska area 4 days earlier, moved southeastward, now located over the southern Rockies within the long wave. Note the cold air advection over Arizona.

At the 500-mb level, 24 hours later, a closed low was not drawn within the trough as shown in Figure 1-29b, however, low development was in progress over eastern Oklahoma and/or Arkansas north of the tighter height contour/thermal gradients.

During the subsequent 24 hours, the storm system moves across the Carolinas and moves offshore near Virginia. In the next 12 hours, the surface low is located off the New Jersey coast and has deepened again. A closed low develops over southeastern Pennsylvania. More than 6 inches of snowfall occurs from West Virginia to Maine. If this pattern develops, expect heavy snow in New England.

e. Midwestern United States. The following information illustrates where the significant snow area is in relation to the storm system. Studies of past Midwest snowstorms indicate that the 500-mb height fall tracks are associated with areas of significant snowfall, and the track of the 500-mb

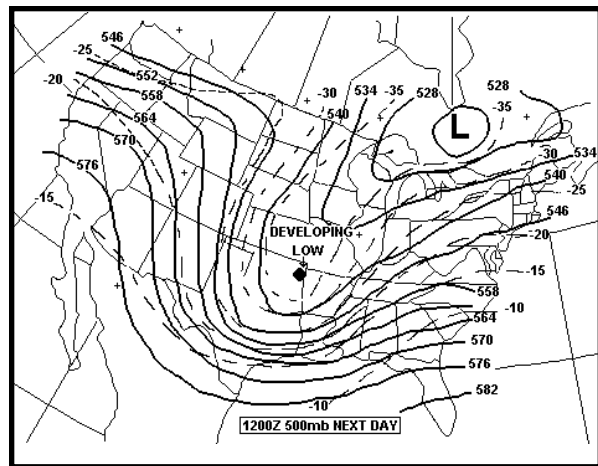

Figure 1-29b. The 500-mb Pattern 24 Hours Later. Low development is in progress over eastern Oklahoma and/or Arkansas north of the tighter height contour/thermal gradients. This chart is valid at the same time as Figure 1-29b.

height fall center (HFC) is the dividing line between frozen and liquid precipitation, with snow occurring to the left (northwest) of the track. The three heavy snow track patterns shown in Figures 1-30 through 1-32 depict various relationships between the surface low, the 500-mb height-fall track, and significant snowfall. Two subjective rules need to be kept in mind when looking at these figures:

- When the surface low is to the left of the 500-mb height fall center track (as in Figure 1-30), the significant snowfall area lies approximately parallel to, and to the left of, either the surface low track or the 500-mb low track, depending on how cold the storm system is. In nearly all cases, snowfall occurs along the 500-mb low track. However, when there is no strong surface high-pressure system over the central and upper Midwest, snowfall occurs along the track of the surface low.

- When the surface low is to the right of the 500-mb height fall center track (as in Figure 1-31), the significant snowfall area lies approximately parallel to and to the left of the 500-mb height fall center track. Usually this surface low/500-mb

height fall center track alignment occurs when a strong surface high-pressure system is present over the central and upper Midwest.

(1) *Heavy Snow Track Pattern 1.* In Figure 1-30, the alignment and movement of the surface low, the 500-mb low, and the 500-mb height fall center tracks are shown. The 500-mb level and the short wave/low is moving towards the Midwest and bottoms out over the southern Rockies/western and northern Texas area before turning northeastward. The main frontal low would likely be along an mP frontal system approaching from the west.

(2) *Heavy Snow Track Pattern 2.* In Figure 1-31, the main surface low is likely to be a frontal low with maritime polar (mP) or continental polar (cP) air. The low is located some distance to the southwest of the upper low-pressure system due to the presence of a strong high-pressure area or ridge over the Midwest. There are many variations to the pattern shown in Figure 1-31 depending upon the paths of the upper and surface low-pressure systems. This is an excellent overrunning situation, and considerable precipitation occurs southward to

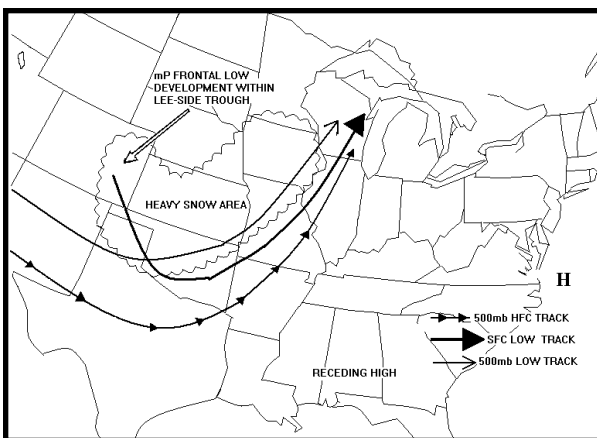

Figure 1-30. Heavy Snow Track Pattern 1. The alignment and movement of the surface low, the 500-mb low, and the 500-mb height fall center tracks are shown

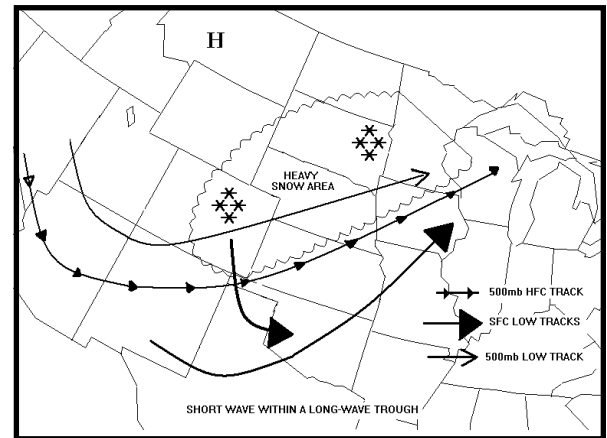

Figure 1-31. Heavy Snow Track Pattern 2. the alignment and movement of the surface low, the 500-mb low, and the 500-mb height fall center tracks are shown, as well as the heavy snow area.

the surface low-pressure center. The division line between rain and snow lies along and to the northwest of the height fall center track.

(3) *Heavy Snow Track Pattern 3.* The alignment of tracks shown in Figure 1-32 is similar to Figure 1-31. The pattern is presented because it occurs quite frequently over the central and western United States and accounts for the majority of missed snow forecasts. In this pattern, a deepening trough over the western United States exists as a long-wave feature. Short waves move through the long wave, bottom out over the Colorado Plateau, and swing northeastward across the Western Plains. At the surface, there is usually a stationary mP or modified cP front lying northeast-southwest across the Midwest. The main low development usually occurs along the front. The snowfall path is usually found along and to the northwest of the 500-mb height fall track, within the colder air of the surface ridge rather than along the main surface low track.

Each storm system track is different; therefore, carefully evaluate the situation and focus on where the 500-mb height fall center bottoms out, where the main surface low develops, and the subsequent

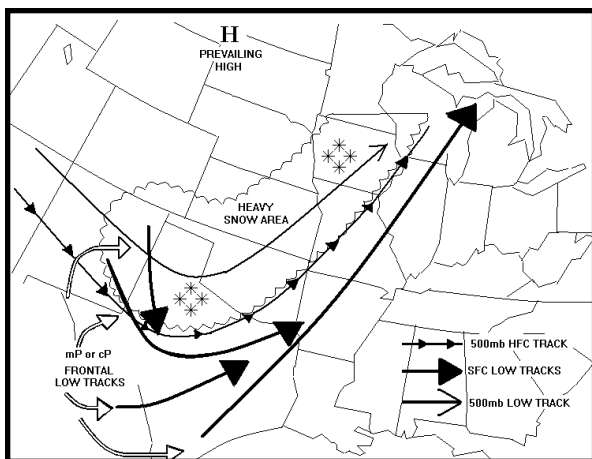

Figure 1-32. Heavy Snow Track Pattern 3. This pattern occurs quite frequently over the central and western United States and accounts for the majority of missed snow forecasts.

path of both features. The location of prevailing surface high-pressure areas during storm development often provides a reliable indication of this relationship.

f. Western U.S. Forecasting heavy snow in the West is more difficult than other areas of the continental United States for two reasons: influences of the terrain, and lack of knowledge concerning circulation patterns associated with heavy snow development in the West. Several subjective rules can help in forecasting heavy snows:

- Most heavy snow occurs under an area bounded by the -20°C and -30°C isotherms at 500 mb.
- Heavy snow occurs between 5,340 to 5,460 meter 1000-500-mb thickness values.
- Storms Moving to the Southeast. The greatest probability of heavy snow is 4 to 5 degrees latitude downstream and 3 degrees left (cold side) of the 500-mb vorticity maximum track.
- Storms Moving to the Northeast. The greatest probability of heavy snow is 3 to 5 degrees latitude downstream and 3 degrees left of the 500-mb vorticity maximum track. A secondary area of maximum snows exists about 7 degrees latitude downstream and 1 to 2 degrees left of the track.

g. Alaska.

(1) *Cold Advection Snow (Southern Alaska).* Follow the guidelines in Table 1-24. This technique works well 12 hours prior to the beginning of cold advection-type snow in southern Alaska, especially near Anchorage. It helps determine if 4 to 8 inches or more of snow, are likely. All parameters should be met, and the stronger the 500-mb trough, the greater the snowfall amount expected.

(2) *Determining Snowfall Accumulation.* Determine the mean mixing ratio from the Fairbanks and McGrath soundings as follows:

Table 1-24. Cold advection snow checklist for southern Alaska.

500 mb	850 mb
Trough or closed low over western Alaska with the lowest heights between McGrath and Kotzebue.	A cold thermal trough from the vicinity of the Chukchi Sea south along the west coast of Alaska or into the southwest interior.
A weak diffluent zone in the northwest Gulf of Alaska and/or over south central Alaska.	McGrath is cooling faster than Fairbanks.
Warm or neutral advection into the southeast Bering Sea while the western Alaska low or trough deepens.	Anchorage is either warming or showing little temperature change.
Ridge over southeast Alaska, or western British Columbia, northward into the Yukon territory of Canada.	The McGrath-Anchorage temperature gradient is increasing, with McGrath expected to be at least 7°C colder than Anchorage within the next 12 hours.
500-mb contours normal to the 850-mb isotherms from the Chukchi Sea southward to Bristol Bay.	Moisture either present at Anchorage at this level or being advected into the area.
	Weakening trough or low in the northwest Gulf of Alaska and/or near Kodiak Island.

Step 1. Choose which of the two soundings is most representative of the synoptic situation.

Step 2. Divide the soundings into three 150-mb layers from 950 mb to 500 mb (950-800, 800-650, 650-500).

Step 3. Obtain the mean mixing ratio of each layer by dividing the dew point trace of the layer into two equal layers. Determine the mixing ratio value that divides the dew point trace into equal areas, interpolating as necessary.

Step 4. Add the three mixing ratios together. The total of all three layers is the value to be used in Table 1-25 .

Table 1-25. Mixing ratio/snowfall duration for Alaskan sites.

Mixing Ratio	Duration of Snowfall In Hours					
	3	6	9	12	18	24
1.0	.2	.3	.5	.6	.9	1.2
1.5	.2	.5	.7	1.0	1.4	2.0
2.0	.3	.6	1.0	1.3	1.9	2.5
2.5	.4	.8	1.2	1.6	2.4	3.2
3.0	.5	1.0	1.5	2.0	3.0	4.0
3.5	.6	1.1	1.7	2.3	3.5	4.6
4.0	.6	1.3	1.9	2.6	3.9	5.2
5.0	.8	1.6	2.4	3.2	4.8	6.4
6.0	1.0	1.9	2.9	3.9	5.9	7.8
7.0	1.1	2.3	3.4	4.5	6.7	9.0
8.0	1.3	2.6	3.9	5.2	7.8	10.4
9.0	1.5	3.0	4.5	6.0	9.0	12.0
10.0	1.6	3.2	4.9	6.5	9.8	13.0

Precautions: Use this table as a guide only.

Step 5. Determine the length of the time significant snowfall is expected. The amount of snowfall accumulation to forecast is found by entering Table 1-25 below with the total mixing ratio and duration of significant snowfall.

(3) *Snow Associated with the Arctic Front in Alaska.* The arctic front is a primary weather producer in Alaska during the winter months. Over the years, Alaskan forecasters accumulated many rules of thumb to help forecast the location of the heaviest snows in relation to the arctic front:

- The majority of the snow falls during the first 12 to 24 hours after the arctic front passes. However, if the front remains just to the south and overrunning conditions develop, light snow may last for many days or several weeks.

- During periods of snow caused by the overrunning of polar air or underrunning by arctic air, there can be periods of increased snowfall caused by a short-wave upper-level trough moving through the area.

- The lowest ceilings and the heaviest snow fall is found in the area between the 500-mb trough and the arctic front. Once the 500-mb trough has passed, expect slowly improving conditions but not a rapid clearing. Slow cooling of the air can cause both stratus and light snow to be very persistent even behind the 500-mb trough. See Figure 1-33.

Chapter 1

- A 500-mb trough parallel to the arctic front and moving towards the front cause it to move southward. The lowest ceilings and heaviest snowfall occur in this area. An occluded front or a 500-mb trough interacting with an arctic front (Figure 1-34) causes most of the heavy snowstorms that occur within interior Alaska. The heaviest snow usually occurs just on the cold-air side of the arctic front near the occluded front or the trough. In this instance, significant snow can occur after the passage of the occluded front or the 500-mb trough. It may also cause the arctic front to move very rapidly into an area previously occupied by relatively warm, moist polar air.

- Another potentially heavy snow producer is a flat 500-mb ridge building rapidly northward into the state from the Pacific Ocean. The associated strong west-southwest flow aloft advects large

amounts of moisture into the interior of Alaska before the colder air mass wears away at low levels.

- If the cold air becomes very deep in the Tanana Valley (6,000 to 8,000 feet), significant amounts of snow can occur from overrunning coming from the south. Normally, southerly flow coming over the Alaskan Range causes downslope and relatively dry conditions. However, when very cold air fills the valley, warm-air advection from the south rides over the cold air trapped in the valley, causing clouds and snow. In this case, the 1000-500-mb thickness value rises rapidly. Note: Shallow arctic air remains until it modifies.

- Snowfall can occur along an arctic front even with negative vorticity advection. However, without positive vorticity advection, the accumulated snowfall is always less than 2 inches.

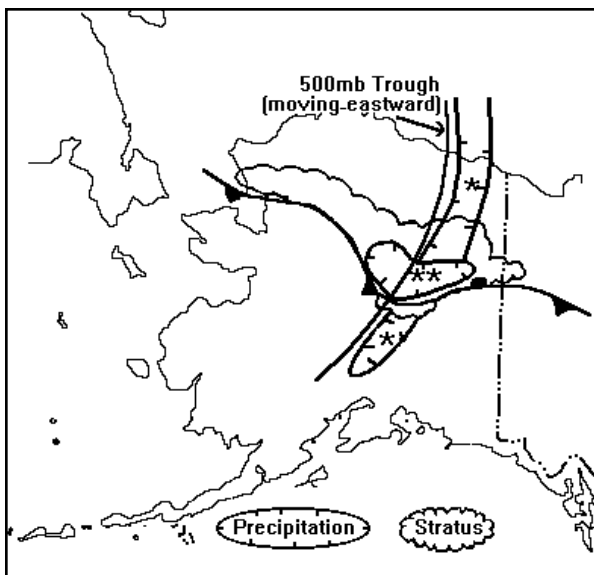

Figure 1-33. The 500-mb Trough and Associated Snow Areas. The lowest ceilings and the heaviest snow fall is found in the area between the 500-mb trough and the arctic front.

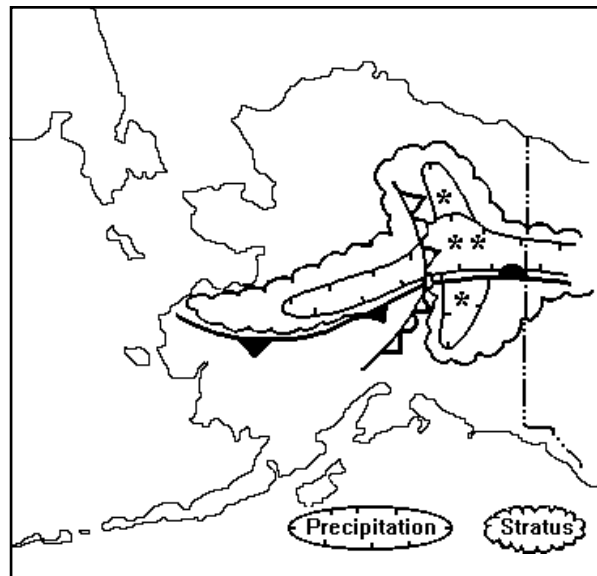

Figure 1-34. Occluded Front and Location of Snow. The heaviest snow usually occurs just on the cold-air side of the arctic front near the occluded front or the trough.

III. SURFACE WINDS. Accurate surface wind forecasting is an important task for a forecaster. Winds are important for safe launch and recovery of aircraft and are vital for successful low-level flight, ground combat operations, and base resource protection.

A. WIND BASICS. This section reviews the basic atmospheric forces responsible for atmospheric winds and describes how these forces combine. It then describes how these wind types are related to flow patterns around pressure systems.

1. Atmospheric Forces.

a. Pressure Gradient Force. This force is responsible for winds in the atmosphere. It arises from spatial differences in pressure in the atmosphere and acts to move air parcels in the direction from higher to lower pressure. The difference in the pressure between two points (over a given distance) in the atmosphere is referred to as the pressure gradient (PG). The magnitude of the PG force is directly proportional to the strength of the PG. Tightly packed isobars indicate a strong PG and are associated with strong winds. In contrast, loosely packed isobars indicate a weak PG and are associated with weak winds.

b. Coriolis Force. The Coriolis force is the “apparent” force that makes any mass, moving free of the Earth’s surface, appear to be deflected from its intended path. This force deflects winds to the right in the Northern Hemisphere and to the left in the Southern Hemisphere, due to the Earth rotating beneath them. The force is inversely proportional to the latitude: it is zero at the equator and increases to a maximum at the poles.

c. Centrifugal and Centripetal Forces. Centrifugal force throws an air parcel outward from the center of rotation. Its strength is directionally proportional to the speed and radius of rotation. Centripetal force, equal in magnitude and opposite in direction to the centrifugal force, attempts to keep the air parcel moving around a curved path (such as around curved height contours on a constant-pressure surface).

d. Frictional Force. Friction directly opposes and retards the motion of one mass in contact with

another. The strength of the force depends on the nature of the contact surface. The more irregular the contact surface, the greater the frictional force. Friction always acts opposite to the direction of motion. With an increase in friction, the wind velocity decreases. This force slows the wind within the boundary layer; the resulting surface wind is about 2/3 of the geostrophic or gradient wind. Friction also causes winds to flow across isobars from high to low pressure (i.e., out of highs and into lows). It may cause the wind to blow up to 50° across isobars over rugged terrain and 10° across isobars over water. The effect of frictional force reaches to about 1,500 feet above ground level (AGL) over smooth terrain and as much as 6,000 feet AGL over mountainous terrain (i.e., up to the “Friction Level” also called the geostrophic wind level and gradient wind level).

2. Wind Types.

a. Geostrophic Wind. This wind results from the balance between the pressure gradient and Coriolis forces, and blows at right angles to the pressure gradient (and parallel to isobars). The geostrophic wind gives a good approximation to the actual wind when friction and isobaric curvature are small.

b. Gradient Wind. This wind results from a balance between the pressure gradient force and the sum of the Coriolis and centripetal forces. It blows parallel to curved isobar. In the middle latitudes, this wind is a better approximation of the actual wind speed than the geostrophic wind speed.

c. Actual Wind. The true observed wind, resulting from all the previously mentioned forces.

3. Flow Around Pressure Systems. Winds generally blow from higher toward lower pressure. The flow is clockwise out of highs and counterclockwise into lows in the Northern Hemisphere. The direction of the flow is opposite in the Southern Hemisphere.

Buy's-Ballot's Law is useful for identifying the general location of highs and lows by observation alone: In the Northern Hemisphere, if you stand with the surface wind to your back and turn 30° clockwise, a low is to your left, and a high is to your

right. In the Southern Hemisphere, with your back to the wind, turn 30° counterclockwise and the low is to your right, while the high is to your left.

B. GENERAL TOOLS FOR FORECASTING SURFACE WINDS.

1. Climatology. Climatology is a useful tool in forecasting winds. It provides historic averages of wind speed and direction over a period of years. Consult it first to identify prevailing winds for the location and time of interest. These prevailing or climatological winds are meso- and micro-scale local phenomena such as land and sea breezes and thermal lows. Variations from the climatological winds are often the result of migratory systems such as lows, highs, and fronts. Climatological winds can be retrieved from several sources, including the following:

a. Station Climatic Summaries. These are regional collections of individual station climatic summaries for seven major geographical areas. These summaries normally include monthly and annual climatic data for the following elements: temperature (means and extremes, daily and monthly), relative humidity, vapor pressure, dew point, pressure altitude, surface winds, precipitation, mean cloud cover, thunderstorm and fog occurrence (mean number of days), and flying weather by ceiling and visibility categories.

b. International Station Meteorological Climate Summary (ISMCS). This is a joint USN/NOAA/USAF summary that contains climatic summaries on CD-ROM.

c. Surface Observation Climatic Summaries (SOCS). Part C of the SOCS includes the percentage frequency of occurrence of peak winds based on month, time, direction, and speed.

Note: The tools noted above can be obtained from the Air Force Weather Technical Library, collocated with the Air Force Combat Climatology Center.

2. Topography. Topography can have an important effect on both the direction and speed of winds. Frictional effects due to rough terrain can slow wind speeds and change their direction.

Mountains upstream may delay or block winds or trigger strong downslope winds.

- Get a detailed topographic map from a tactical product, atlas, or National Imagery and Mapping Agency.

- Locate the station of interest.

- Note the topography around the station, such as hills, valleys, lakes, etc.

3. Trends. If the air mass and pressure systems affecting the area of interest are not expected to change, use persistence for short-term forecasting. This is especially true in tropical locations, where conditions remain much the same from day to day. In these locations, diurnal variations in winds usually dominate. Trend charts, such as the example shown in Figure 1-35, are excellent tools to track and forecast these “persistent” winds.

4. Geostrophic Winds. Forecasters can get a good estimate of short-term surface winds by knowing the geostrophic wind (just above the friction layer) and correcting it for friction. Their sensitivity to changes in the pressure field, however, makes geostrophic winds unsuitable for long-term forecasting. Geostrophic winds also do not work well in areas of strongly curved isobars. Use geostrophic winds in a 90-minute to 2-hour window from valid time for best results.

- Obtain a value of the geostrophic wind at the location of interest. To obtain these values, use the VAD profile from Doppler radar, a representative sounding, an AWDS or NCEP product, etc.

- Mean surface wind speed is about 2/3 of the geostrophic wind during the daytime period of maximum heating (due to frictional effects). The surface wind may not be representative if the geostrophic wind is less than 15 knots.

- The mean wind direction in the Northern Hemisphere deviates from the geostrophic direction by minus 10° over ocean areas and up to minus 50° over rugged terrain. Average deviation at a station should be determined locally.

STATION - DON MUANG, TH

YEAR - 68 MONTH- JAN DAY	0000	0100	0200	0300	0400	0500	0600	0700	0800	0900	1000	1100
19	○	23 382 22 80	22 381 21 80	22 379 21 80	22 380 21 80	22 381 21 80	21 383 21 80	VIS 3 S-SW 22 385 21	VIS 3 S-SW 22 386 21	VIS 24 S-SW 25 383 22	28 383 24	23 387 23 80
20	24 381 23 80	24 380 22 80	23 378 22 80	23 377 22 80	23 377 22 80	22 378 21 80	VIS 12 W-NW 22 384 21	VIS 16 S 22 384 21	23 383 22 80	25 385 23 80	27 385 23 80	23 384 21 80
21	24 380 23 80	23 380 21 80	23 379 22 80	22 377 21 80	23 377 22 80	22 377 21 80	21 379 21 80	VIS 4 NW 21 380 21	VIS 24 S-SW 22 382 21	24 383 23 80	27 384 21 80	23 383 20 80

Figure 1-35. Example of a Trend Chart Used to Forecast “Persistent” Winds.

• Cautions:

- Do not use geostrophic winds to forecast surface winds with nearby convection.
- Use geostrophic winds to forecast surface wind speeds after a frontal passage, but not to forecast wind shifts with frontal passage.
- Surface winds may differ considerably from the geostrophic wind under a shallow inversion.
- Geostrophic winds may overestimate the actual wind when a low-pressure center is within 200 miles of the area being evaluated.

5. **Gradient Winds.** Gradient wind provide a better estimate of the actual wind in middle latitudes when the flow is significantly curved. However, some adjustment must be made to account for frictional effects on the wind. The following are valid for flow around a low in the Northern Hemisphere:

- From the forecast location, choose a reference point 6° of latitude (~360 NM) away and as perpendicular as possible to the surface isobars. A 6° circle is best to find the reference point, as shown in Figure 1-36.
- Find the difference in pressure (mb) between the reference point pressure value and the forecast point pressure value. From Figure 1-36: 1000.0 - 976.0 = 24 mb.

• Use the numerical difference (mb) found to

represent the gradient wind speed in knots (e.g., 24 mb = 24 knots).

- Use 50 percent of the gradient wind as a forecast of the mean surface wind speed.
- Use 80-90 percent of the gradient wind speed as the value for daytime peak gusts.

• Cautions:

- This method is more accurate than using the geostrophic wind when isobaric flow is markedly curved or when the wind speeds are greater than 50 knots.
- Gradient wind speed decreases in strength with either increasing latitude or air density (i.e., gradient wind speed is inversely proportional to both changes in latitude and air density).

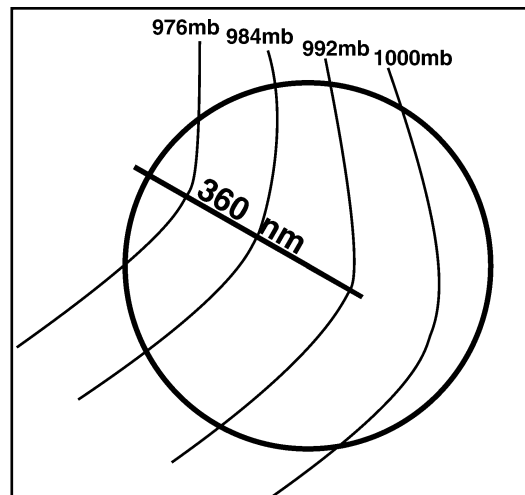

Figure 1-36. Pressure Gradient Method for Determining Surface Winds.

6. Isallobaric Winds. Isallobaric winds result from changes in pressure over time. Isallobaric winds flow perpendicular to isallobaric contours from an isallobaric high to a low (Figure 1-37). Gradient and geostrophic wind speeds should be adjusted for the isallobaric flow to better estimate actual winds. Although the gradient wind (adjusted for the effects of friction) is a good estimate of the actual wind when the pressure is unchanging, it is not always accurate when pressure rapidly changes.

- Display a geostrophic/gradient wind chart.
- Overlay contours of pressure tendency (e.g., PP in AWDS) using a base of zero and an increment of 1.0 mb.
- Locate closed contours of pressure tendency to identify isallobaric centers for flow direction.
- Compute the distance between pressure tendency contours for your location.
- Apply the contour spacing value obtained to the appropriate Variations of Isallobaric Wind Product (Figures 1-38 a-f) to get correction speed.
- If the isallobaric flow is opposite to the geostrophic wind direction, subtract the value from the geostrophic speed. If the isallobaric flow is the same as the geostrophic wind direction, add the correction value to the geostrophic speed (see example 1).
- For situations where there is a noticeable angle between the isallobaric flow and the

geostrophic wind, enter Table 26a-f with the angle and speeds to estimate an actual wind speed (see example 2).

Example 1: In Figure 1-37, point W in northern Oklahoma is located near 36.5°N. The contour spacing is 2° latitude or ~120 NM. At 36.5°, use Figure 1-38b (35°N) to get the variation in isallobaric wind. At 120 NM, the interpolated isallobaric wind speed is 7 knots. Since the wind at W (15010) is in the same direction as the isallobaric flow, simply add the winds (i.e., adjusted wind speed = 10 knots + 7 knots = 17 knots).

Example 2: In Figure 1-37, point Z in central Minnesota is near 45° N and has a contour spacing of 1 mb per 160 NM. Figure 1-38c gives an isallobaric windspeed of 3 knots. However, since the geostrophic wind direction is about 120° different than the isallobaric, enter Table 1-26d with the geostrophic speed (13 knots) and isallobaric speed (3 kts) to estimate a windspeed of 10 knots.

Some final guidance on using isallobaric winds to forecast surface winds:

- Lows tend to move toward the center of isallobaric lows, where the air is converging horizontally and moving upward.
- Highs tend to move toward the center of isallobaric highs, where the air is subsiding and diverging horizontally.
- Isallobaric winds are normally less than 10 knots.

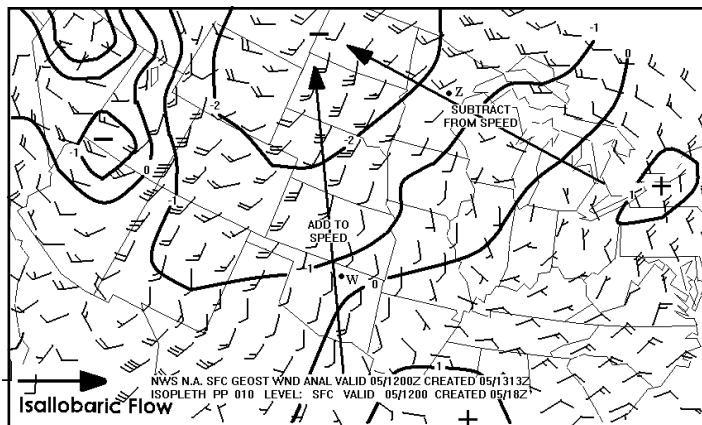
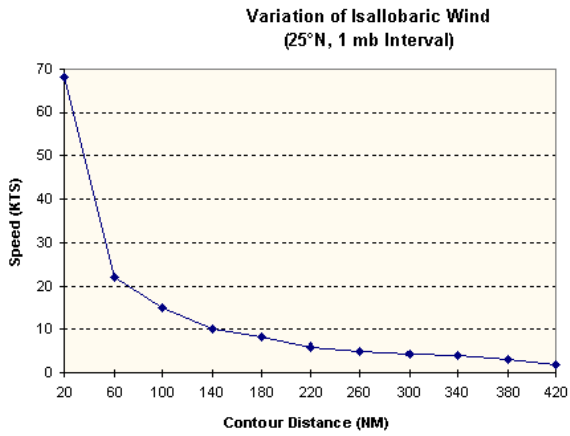
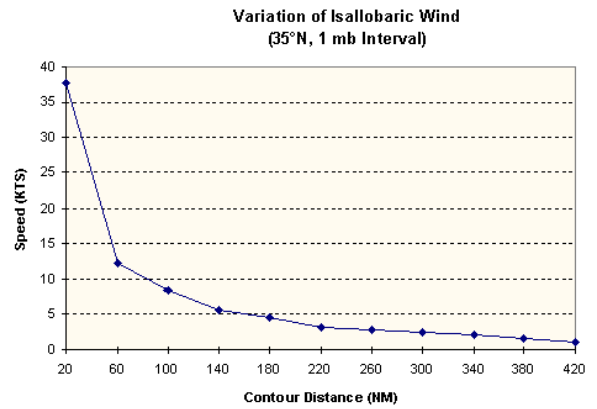

Figure 1-37. Isallobaric Flow. Isallobaric winds flow perpendicular to isallobaric contours from an isallobaric high to an isallobaric low.



(a) 25°N



(b) 35°N

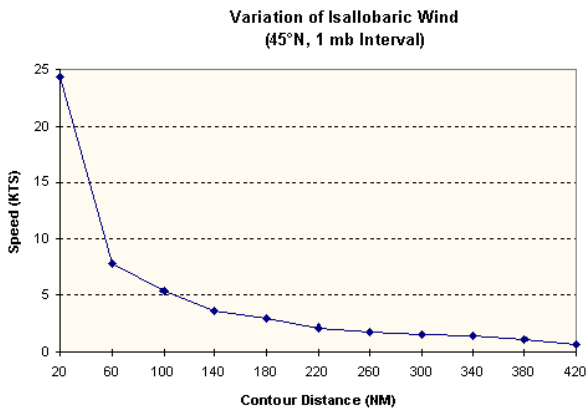

(c) 45°N

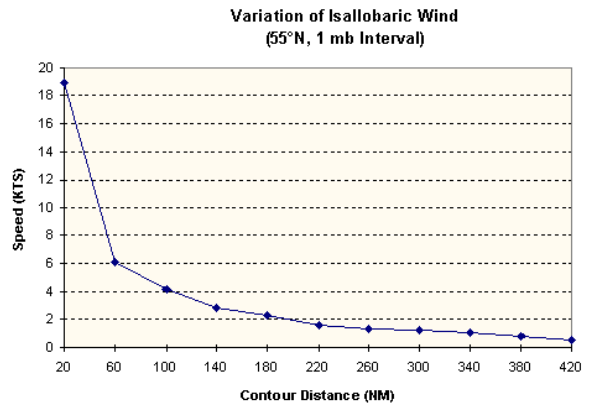

(d) 55°N

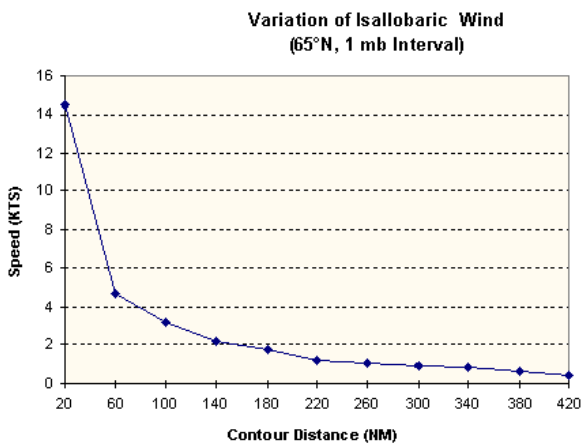

(e) 65°N

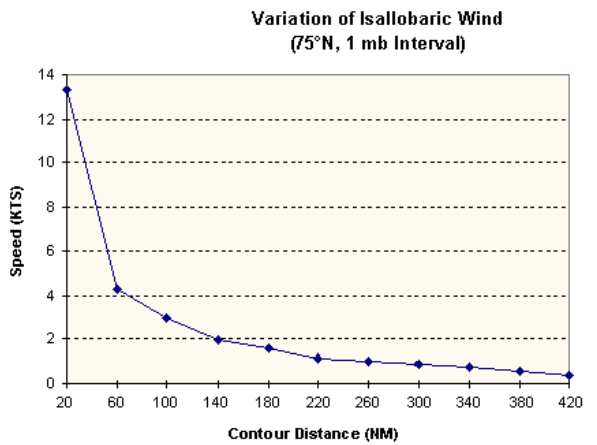

(f) 75°N

Figure 38a-f. Variation of Isallobaric Winds by Latitude.

Table 1-26 a-f. Estimating actual windspeed. Knowing the difference in direction of isallobaric flow vector and geostrophic wind vector, enter appropriate table with wind speeds to estimate actual surface winds.

(a) Difference in Direction of 30°

		Speed B									
		5	10	15	20	25	30	35	40	45	50
Speed A	5	9	14	19	24	29	34	39	44	49	54
	10	14	19	24	29	34	38	43	48	53	58
	15	19	24	28	33	38	43	48	53	58	63
	20	24	29	33	38	43	48	53	58	63	68
	25	29	34	38	43	48	53	58	62	67	72
	30	34	38	43	48	53	57	62	67	72	77
	35	39	43	48	53	58	62	67	72	77	82
	40	44	48	53	58	62	67	72	77	82	86
	45	49	53	58	63	67	72	77	82	86	91
	50	54	58	63	68	72	77	82	86	91	96

(b) Difference in Direction of 60°

		Speed B									
		5	10	15	20	25	30	35	40	45	50
Speed A	5	8	13	18	22	27	32	37	42	47	52
	10	13	17	21	26	31	36	40	45	50	55
	15	18	21	25	30	35	39	44	49	54	58
	20	22	26	30	34	39	43	48	52	57	62
	25	27	31	35	39	43	47	52	56	61	66
	30	32	36	39	43	47	51	56	60	65	70
	35	37	40	44	48	52	56	60	65	69	73
	40	42	45	49	52	56	60	65	69	73	78
	45	47	50	54	57	61	65	69	73	77	82
	50	52	55	58	62	66	70	73	78	82	86

(c) Difference in Direction of 90°

		Speed B									
		5	10	15	20	25	30	35	40	45	50
Speed A	5	7	11	15	20	25	30	35	40	45	50
	10	11	14	18	22	26	31	36	41	46	50
	15	15	18	21	25	29	33	38	42	47	52
	20	20	22	25	28	32	36	40	44	49	53
	25	25	26	29	32	35	39	43	47	51	55
	30	30	31	33	36	39	42	46	50	54	58
	35	35	36	38	40	43	46	49	53	57	61
	40	40	41	42	44	47	50	53	56	60	64
	45	45	46	47	49	51	54	57	60	63	67
	50	50	50	52	53	55	58	61	64	67	70

7. Diurnal Temperature Data. Surface winds may change as a result of diurnal temperature changes and temperature changes associated with the formation or destruction of low-level temperature inversions. Generally, maximum and minimum wind speeds occur, respectively, at the times of maximum and minimum temperatures. Most diurnal effects occur in a weak pressure gradient as the result of formation of a low-level temperature inversion. The inversion, once set in

(d) Difference in Direction of 120°

		Speed B									
		5	10	15	20	25	30	35	40	45	50
Speed A	5	5	8	13	18	22	27	32	37	42	47
	10	8	10	13	17	21	26	31	36	40	45
	15	13	13	15	18	21	25	30	35	39	44
	20	18	17	18	20	22	26	30	34	39	43
	25	22	21	21	22	25	27	31	35	39	43
	30	27	26	25	26	27	30	32	36	39	43
	35	32	31	30	30	31	32	35	37	40	44
	40	37	36	35	34	35	36	37	40	42	45
	45	42	40	39	39	39	39	40	42	45	47
	50	47	45	44	43	43	43	44	45	47	50

(e) Difference in Direction of 150°

		Speed B									
		5	10	15	20	25	30	35	40	45	50
Speed A	5	2	6	10	15	20	25	30	35	40	45
	10	6	5	8	12	17	21	26	31	36	41
	15	10	8	7	10	14	18	23	28	32	37
	20	15	12	10	10	12	16	20	24	29	34
	25	20	17	14	12	12	15	18	22	26	30
	30	25	21	18	16	15	15	17	20	24	28
	35	30	26	23	20	18	17	18	20	22	26
	40	35	31	28	24	22	20	20	20	22	25
	45	40	36	32	29	26	24	22	22	23	25
	50	45	41	37	34	30	28	26	25	25	25

(f) Difference in Direction of 180°

		Speed B									
		5	10	15	20	25	30	35	40	45	50
Speed A	5	0	5	10	15	20	25	30	35	40	45
	10	5	0	5	10	15	20	25	30	35	40
	15	10	5	0	5	10	15	20	25	30	35
	20	15	10	5	0	5	10	15	20	25	30
	25	20	15	10	5	0	5	10	15	20	25
	30	25	20	15	10	5	0	5	10	15	20
	35	30	25	20	15	10	5	0	5	10	15
	40	35	30	25	20	15	10	5	0	5	10
	45	40	35	30	25	20	15	10	5	0	5
	50	45	40	35	30	25	20	15	10	5	0

the evening, does not allow higher wind speeds aloft to mix down to the surface. Winds usually stay light throughout the night and early morning until the surface inversion breaks.

- Use a Skew-T to determine if a low-level surface inversion is present.
- If surface heating is not sufficient to break the inversion, forecast unchanged wind speeds.

- If winds increase above the inversion (and the inversion is below 5,000 feet), expect maximum gusts during maximum heating to be 80 percent of the 5,000 foot wind speed.

- If winds do not increase above the inversion, forecast 40 to 70 percent of the 5,000-foot wind speed to mix down to the surface.

- Caveats:

- Percentages shown above are only general estimates; actual values may differ widely due to local terrain. Determine appropriate values locally from forecast studies.

- Normally, maximum gustiness occurs at the time of maximum heating. Short periods of maximum gusts may also occur just as the inversion breaks, which may occur before maximum heating.

- Other phenomena, such as propagating outflow boundaries from previous days' thunderstorms, may be sufficiently strong to temporarily break the inversion.

- With southwest winds, average gusts approximate 70 percent of the maximum wind observed in low-level wind data. Peak gusts may equal the highest wind speed reported in the low-level wind field during maximum heating.

- With west-northwest winds and moderate to strong cold-air advection, peak speeds can exceed the highest value observed in the low-level wind field.

- Under a strong pressure gradient, winds continue throughout the day or night with little diurnal change.

8. Numerical Output Products. Numerical output, such as Model Output Statistics (MOS) guidance products, are objective tools used to forecast wind speeds, directions, and other weather elements. MOS values are produced for specific locations; other locations should conduct local studies to determine if the MOS values for a nearby

location are useful for their station location. Since MOS bulletins are based on Numerical Weather Prediction (NWP) model forecasts, initialize the models before using the MOS guidance.

a. CONUS. NGM FOUMXX and Eta FOUSXX KWBC bulletins show wind speed and direction in the layer from surface to 96 mb out to 60 hours. Use these outputs to note trends, rather than as an exact guide to winds. The MOS does not handle rare events such as tropical cyclones well; later MOS guidance converges towards climatology.

b. Pacific Theater. NOGAPs FXPAXX KGWC bulletins show wind speed and direction at an approximate gradient level (2,000 feet to 36 hours). Generally, surface winds are 60 to 100 percent of these winds depending on terrain and synoptic situation. The proportion of gradient wind to surface wind should be determined by local studies.

c. European Theater. German BLM FOEUXX ETGX, German EM FMDLXX EDZW, and the AFGWC BLM FOEUXX KGWC bulletins show wind speed and direction at the surface. FOEUXX ETGX is valid to 36 hours, FMDLXX EDZW for 72 hours at 6-hour increments, and FOEUXX KGWC for 3 hours.

Note: Deep systems that do not initialize well may lead to large errors in MOS guidance.

9. Wind Profiles. Wind profiles include data from Skew-T, Wind Profilers, and the WSR-88D Vertical Azimuth Display Wind Profile (VWP). These vertical profiles show the winds in a small cross-section of the atmosphere but do represent the winds over a much larger horizontal area. The low-level jet can often be seen on the profiles.

- Read the winds off the display.

- Determine the temperature profile either from a current or forecast Skew-T or upper-air product.

- Follow rules given above in the sections on *Geostrophic Winds* and *Diurnal Temperature Data*.

10. Uniform Gridded Data Fields (UGDFs). UGDFs are forecast fields displayed on AWDS or similar weather communications and processing equipment. These fields can be displayed vertically in a cross-section or horizontally in a LAWC.

- Using UGDFs, plot a forecast Skew-T for the time and place of interest.
- Follow rules given in the section on *Diurnal Temperature Data*.
- Using 1000-mb UGDFs, plot a forecast LAWC for the time and place of interest.
- Refer to the section on *Gradient Winds* for use with the LAWC.

11. Satellite-Derived Winds. Satellite-derived low-level winds (5,000 feet and below) can be used to forecast surface winds. Although not as accurate as radiosonde winds, satellite-derived winds are useful in data-sparse areas. Bulletins are TWXNXX KWBC in the Northern Hemisphere and TWXSXX KWBC in the Southern Hemisphere.

- Extract low-level wind information from bulletins.
- See the *Gradient Winds* section for application rules.

12. Satellite Imagery. Low-level cloud patterns from satellite imagery are valuable in forecasting surface winds, especially in data-sparse oceanic areas. Best images to use are high resolution (1 to

4 km) visible and infrared images. Keep in mind that the winds at cloud level may not be the same as the surface wind. Study the terrain of the satellite photo (using an atlas or tactical maps). Determine the type and shape of clouds, then use the following guidance:

a. Open-cell Cumulus. (Refer to Figure 1-39.)

- Associated with straight-line or cyclonic flow.
- Doughnut shape with a hole: less than 10 knots.
- Elongated doughnut shape: 11 to 20 knots.
- Arc shape: 21 to 30 knots.
- Solid elongated cloud: greater than 30 knots.

b. Closed-cell Stratocumulus.

- Associated with anticyclonic flow.
- Wind direction hard to determine by cloud alone. Use other clues.
- Wind speeds are generally less than 20 knots.

c. Stratocumulus Lines.

- Seen off south or east coastlines or large lakes.

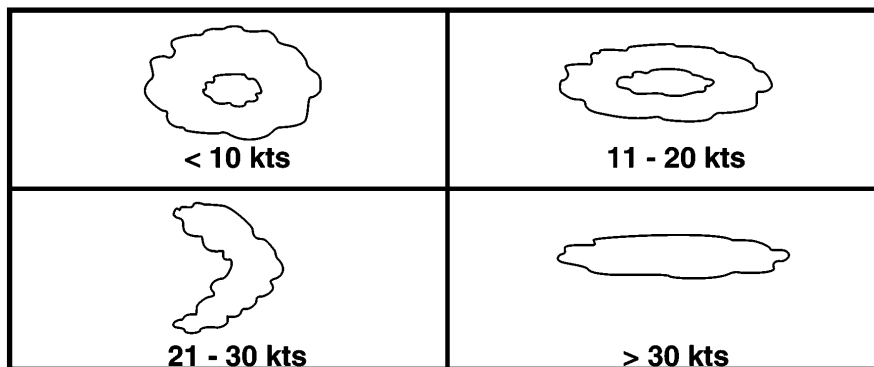

Figure 1-39. Open-Cell Cumulus Shapes. These formations are associated with straight-line or cyclonic flow.

- Associated with cyclonic, anticyclonic, or straight-line flow.

- Wind almost parallel to cloud lines.

- The smaller the cloud elements, the stronger the winds. Visible separation between cloud elements indicates greater than 20 knots.

d. Cumulus Lines or Streets.

- Mainly in tropical and subtropical regions.

- Wind almost parallel to cloud lines.

e. Smoke/Ash/Dust.

- Seen at different levels.

- Sharp boundaries are upstream, diffuse boundaries are downstream.

f. Leaside Clearing. Indicates winds crossing ridgeline more perpendicular than 45°.

g. Lakes in Summer.

- Cumulus clouds dissipate as they move over cooler lakes.

- Cloud-free area occurs downstream over land, before clouds start developing.

h. Lakes in Winter.

- Colder, drier air moving over an unfrozen lake forms stratocumulus lines downstream over the lake and land.

- A cloud-free region often exists on the upstream side.

i. Ice Packs on Large Lakes and Seas. Persistent winds push the ice away from the upstream shore and pack it against the downstream shore.

j. Bow Waves, Plume Clouds, Karman Vortices. These features can be found downstream in windflow.

k. Strongest Wind Regions in Extratropical Cyclones. The areas of strongest winds during various phases in an extratropical cyclone are shown in Figure 1-40. See if outlined areas are moving over your area of interest and use other tools to forecast wind strength.

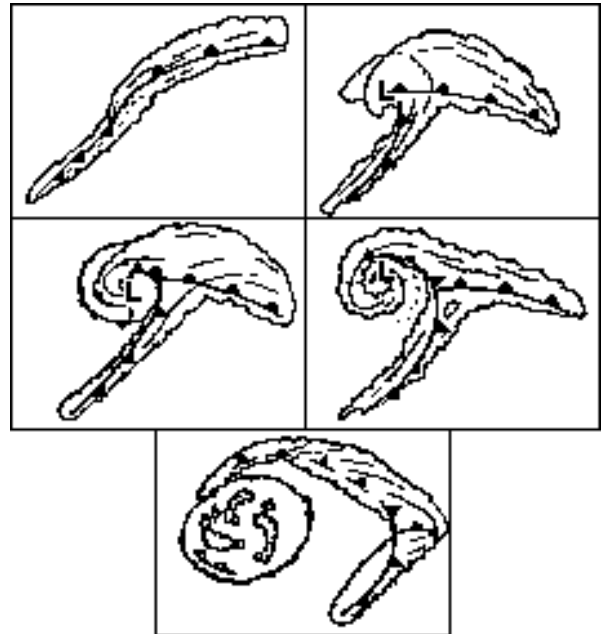

Figure 1-40. Strongest Winds in an Extratropical Cyclone. Strongest winds are shown with a dashed outline.

13. Elevation Effects. A decrease of pressure and density of the air and decrease of friction with elevation, cause wind speeds on average to increase about 1 to 2 knots for every 2000 feet above sea level. Table 1-27 shows the increase in wind speed with elevation at specific temperatures. After making wind forecasts using other tools, adjust wind speeds for elevation using Table 1-27.

14. Local Wind Effects. After using the above general wind forecasting techniques, forecasters should fine tune their wind forecasts based on local effects, many of which are described below.

a. Drainage Wind. This wind occurs at night with strong cooling and a very weak pressure gradient. Due to variations in surface conditions, radiational cooling cools the air in contact with the surface more rapidly at some locations than others. Since cooler air is heavier than warmer air, it sinks to lower elevations in sloping terrain.

- Requires only a very shallow terrain slope and has occurred with slopes less than 200 feet.
- Speeds rarely exceed 2 to 3 knots.
- Occurs when surface ridging affects the area, so it can be forecast using surface analysis or prognosis products.

b. Mountain Breeze. This breeze is simply a stronger case of drainage wind in a mountainous area. At night, radiation cools the mountainside air faster than the air in a valley. As the cooler air becomes denser, it sinks toward the lower elevations and collects in the valleys.

- Speeds may reach 11 to 13 knots.
- The cooler air may become several hundred feet thick in the valley.
- Can be forecast using a sequence of surface analyses and prognosis products.

c. Fall Wind. Typically, this cold wind originates in snow-covered mountains under high pressure. The air on the snow-covered mountains is cooled enough so that it remains colder than the valley air despite adiabatic warming upon descent. Near the edges of the mountains, the horizontal pressure gradient force, along with gravity, causes the cold air to flow across the isobars through gaps and saddles down to lower elevations. This colder, denser air descends rapidly to the valley below. The *glacier wind*, one type of fall wind, is most noticeable during summer due to the large temperature differences. The *bora*, another type of fall wind, occurs mainly in Europe. It also occurs in North America when cold air flows down the east slopes of the Rockies in Alberta and Montana.

Table 1-27. Increase of wind speed with height.

Elevation (ft)	Temperature °C (°F)	Surface Wind 35 (kt)	Surface Wind 50 (kt)
		Speed at Altitude	Speed at Altitude
2000	7 (44)	36	52
4000	4 (38)	37	54
6000	0 (32)	39	56
8000	-3 (26)	40	58
10000	-7 (20)	41	59
12000	-10 (14)	42	61
14000	-13 (8)	43	64

- The fall winds begin once the high pressure is in place.
- Channeled fall winds have been known to reach 100 knots for days at a time.
- Temperatures in lower elevations may drop more than 11°C (20°F) when the breeze begins.
- Can be forecast using a sequence of surface analyses and prognosis products.

d. Valley Breeze. These winds flow in the opposite direction to the mountain breeze described above. The valley breeze develops during the day as the mountain slopes become heated by the sun (more quickly than the protected valleys). Air from the valley then “slides” upward to replace the buoyant, heated air rising from the mountain slopes.

- The valley breeze averages about 13 knots.
- The stronger the heating, the stronger the wind. Therefore, early afternoon is the most favorable time for the strongest winds.
- The best conditions for valley breeze development are clear skies and a weak synoptic pressure gradient.
- Can be forecast using a sequence of surface analyses and prognosis products.

e. Foehn (Chinook) Wind. This warm wind flows down the leeward side of mountains. The wind forms when moist air is forced to ascend on the windward side of a mountain and then descends on the leeward side. As the air rises on the windward side, it expands and cools at the relatively slow moist adiabatic cooling rate. The moisture in the air condenses into clouds and precipitates out. As the now dry air descends on the leeward side, it is compressed and heated relatively quickly at the dry adiabatic heating rate. The result is a very strong, warm, and dry downslope wind.

- The winds start when strong winds aloft flow perpendicular to a mountain range. A leeward trough may form consequently, further forcing the air downslope.

- Look for clouds and precipitation on the windward side of the mountain range ending suddenly at or near the ridgeline in a “foehn wall” (see Figure 1-108).

• Conditions associated with mountain-wave turbulence may also cause Chinooks. Lenticular clouds usually associated with mountain-wave turbulence may signal a Chinook.

- Temperatures may rise as much as 28°C (50°F) in a few minutes at the base of the mountains. Melting snow cover can cause flash flooding

f. Land and Sea Breezes. Sea breezes blow onshore from sea to land during the day; land breezes blow offshore from land to sea during the night. These breezes result from differential heating between land and water. During the day, land heats faster than water; cool air over the water flows in from the sea—as the sea breeze—to replace the warmer air rising over the land. At night, the opposite occurs: the warmer rising air over the ocean is replaced by cooler air from the land—the land breeze. In the sea and land breezes, the return flow aloft often forms nearly closed circulation cells.

- Sea Breeze.
 - Occurs throughout the year in the tropics, but mainly in the summer in higher latitudes.
 - Begins to develop 3 to 4 hours after sunrise and peaks in the afternoon; the wind is gusty and may be variable.
 - Circulation often extends 12 miles over land and water (35 to 45 miles is not unusual).
 - The depth of the circulation varies from 13,000 feet in the tropics to 3,000 feet in higher latitudes.
 - Best conditions are a weak pressure gradient and clear skies, allowing strong heating.
 - If the ocean temperature just offshore is unusually cold, fog or low stratus clouds may accompany the sea breeze. The fog and stratus generally dissipate rapidly over the warm land.

Chapter 1

- Horizontal convergence and convection (forming a sea-breeze front) may mark the sea breeze's farthest penetration inland.

- Can be forecast using a sequence of surface analyses and prognosis products.

- Land Breeze.

- Much weaker than the sea breeze, with smaller horizontal and vertical dimensions.

- Normally begins shortly before midnight and peaks near sunrise.

C. SPECIALIZED AIRFIELD OPERATIONS TOPICS.

1. Runway Crosswinds. A crosswind is the wind component directed perpendicular to a runway. Winds parallel to a runway have zero crosswind component, regardless of speed, while winds perpendicular to the runway have a crosswind component equal to their actual wind speeds.

Crosswind component values can be calculated using the following technique:

Step 1. Determine the absolute (positive) difference in degrees between the direction of the runway heading and the direction of the actual wind (e.g., runway orientation is 030°/210°; wind direction is 090°). Difference off runway is 60° (90° - 30° = 60°).

Step 2. Using Table 1-28, relate this direction difference to the actual wind speed to find the crosswind component.

2. Low-Level Wind Shear. Wind shear is a change in wind direction, wind speed, or both, along a given direction in space (e.g., along a horizontal or vertical distance). The strongest wind shears are associated with abrupt changes in wind direction and/or speed over a short distance. Low-level wind shear is particularly hazardous to aviation operations: it occurs so close to the surface that pilots often do not have enough time to compensate for its effects.

Table 1-28. Crosswind component table.

Speed (kts)	Angle Between Wind Direction and Heading (°)								
	10	20	30	40	50	60	70	80	90
5	1	2	3	3	4	4	5	5	5
10	2	3	5	6	8	9	9	10	10
15	3	5	8	10	11	13	14	15	15
20	3	7	10	13	15	17	19	20	20
25	4	9	13	16	19	22	23	25	25
30	5	10	15	19	23	26	28	30	30
35	6	12	18	22	27	30	33	34	35
40	7	14	20	26	31	35	38	39	40
45	8	15	23	29	34	39	42	44	45
50	9	17	25	32	38	43	47	49	50
55	10	19	28	35	42	48	52	54	55
60	10	21	30	39	46	52	56	59	60
65	11	22	33	42	50	56	61	64	65
70	12	24	35	45	54	61	66	69	70
75	13	26	38	48	57	65	70	74	75
80	14	27	40	51	61	69	75	79	80
85	15	29	43	55	65	74	80	84	85
90	16	31	45	58	69	78	85	89	90
95	16	32	48	61	73	82	89	94	95

1. Are thunderstorms forecast or observed within 10 NM?	Yes, LLWS assumed. No, go to Step 2.
2. Is there a low-level jet below 2,000 ft?	Yes, forecast LLWS. No, go to Step 3.
3. Is the sustained surface wind speed 30 kt or greater?	Yes, forecast LLWS. No, go to Step 4.
4. Is the surface wind speed 10 kt or greater?	Yes, go to Step 5. No, go to Step 6.
5. Is the difference between the gradient wind speed and two times the surface wind speed 20 kt or greater?	Yes, forecast LLWS. No, go to Step 9.
6. Is there an inversion or isothermal layer below 2,000 ft?	Yes, go to Step 7. No, go to Step 8.
7. Is the value of the vector difference between the gradient wind and the surface wind 30 kt or greater?	Yes, forecast LLWS. No, go to Step 9.
8. Is the value of the vector difference between the gradient wind and the surface wind 35 kt?	Yes, forecast LLWS. No, go to Step 9.
9. Is a surface front present or forecasted to be in the area?	Yes, go to Step 10. No, go to Step 13.
10. Is the vector difference across the front equal to or greater than 20 kt over 50 NM (see Table 1-29)?	Yes, forecast LLWS. No, go to Step 11.
11. Is the temperature gradient across the front 5°C (10°F) or more per 50 NM?	Yes, forecast LLWS. No, go to Step 12.
12. Is the speed of movement of a front 30 kt or more?	Yes, forecast LLWS No, go to Step 13.
13. Located in the Western United States?	Yes, go to Step 14. No, go to Step 15.
14. Do the following conditions exist?	Yes, forecast LLWS. No, go to Step 15.
a. Cloud bases > 8000 above ground level.	
b. Surface temperatures > 27°C (80°F).	
c. Surface temperatures/dew point spread greater than 23°C (40°F).	
d. Virga, convective activity within 10 NM of runway approach.	
15. Forecast no significant low-level wind shear.	

Figure 1-41. Low-level Wind Shear Decision Tree. Local effects are not addressed.

Wind shear is often associated with fronts, inversions, and thunderstorms. The checklist in Figure 1-41 is adapted from The United Kingdom Meteorological Office and Continental Airlines low-

level wind shear rules. The conditions are not all inclusive and local effects (e.g., mountain waves, local terrain, etc.) are not addressed. (*Note:* The gradient level is assumed 2,000 feet above the

Table 1-29a-g. Difference of direction.

(a) 0° to 12.5°

		Speed B									
		5	10	15	20	25	30	35	40	45	50
Speed A	5	0	5	10	15	20	25	30	35	40	45
	10	5	1	5	10	15	20	25	30	35	40
	15	10	5	1	5	10	15	20	25	30	35
	20	15	10	5	2	5	10	15	20	25	30
	25	20	15	10	5	2	5	10	15	20	25
	30	25	20	15	10	5	3	6	10	15	20
	35	30	25	20	15	10	6	3	6	10	15
	40	35	30	25	20	15	10	6	4	6	11
	45	40	35	30	25	20	15	10	6	4	7
	50	45	40	35	30	25	20	15	11	7	5

(d) 77.6° to 102.5°

		Speed B									
		5	10	15	20	25	30	35	40	45	50
Speed A	5	7	11	15	20	25	30	35	40	45	50
	10	11	14	18	22	26	31	36	41	46	50
	15	15	18	21	25	29	33	38	42	47	52
	20	20	22	25	28	32	36	40	44	49	53
	25	25	26	29	32	35	39	43	47	51	55
	30	30	31	33	36	39	42	46	50	54	58
	35	35	36	38	40	43	46	49	53	57	61
	40	40	41	42	44	47	50	53	56	60	64
	45	45	46	47	49	51	54	57	60	63	67
	50	50	50	52	53	55	58	61	64	67	70

(b) 12.6° to 45°

		Speed B									
		5	10	15	20	25	30	35	40	45	50
Speed A	5	2	6	10	15	20	25	30	35	40	45
	10	6	4	7	12	16	21	26	31	36	41
	15	10	7	7	9	13	18	23	27	32	37
	20	15	12	9	9	12	15	19	24	29	33
	25	20	16	13	12	12	14	17	21	26	30
	30	25	21	18	15	14	14	16	19	23	27
	35	30	26	23	19	17	16	17	19	22	25
	40	35	31	27	24	21	19	19	19	21	24
	45	40	36	32	29	26	23	22	21	22	24
	50	45	41	37	33	30	27	25	24	24	24

(e) 102.6° to 135°

		Speed B									
		5	10	15	20	25	30	35	40	45	50
Speed A	5	8	13	17	22	27	32	37	42	47	52
	10	13	17	21	26	31	35	40	45	50	55
	15	17	21	25	30	34	39	44	49	53	58
	20	22	26	30	34	38	43	47	52	57	62
	25	27	31	34	38	43	47	51	56	61	65
	30	32	35	39	43	47	51	56	60	65	69
	35	37	40	44	47	51	56	60	64	69	73
	40	42	45	49	52	56	60	64	68	73	77
	45	47	50	53	57	61	65	69	73	77	81
	50	52	55	58	62	65	69	73	77	81	86

(c) 45.1° to 77.5°

		Speed B									
		5	10	15	20	25	30	35	40	45	50
Speed A	5	5	8	13	18	23	27	32	37	42	47
	10	8	10	13	17	22	26	31	36	41	46
	15	13	13	15	18	22	26	30	35	40	44
	20	18	17	18	20	23	26	30	35	39	44
	25	23	22	22	23	25	28	31	35	39	43
	30	27	26	26	26	28	30	33	36	40	44
	35	32	31	30	30	31	33	35	38	41	45
	40	37	36	35	35	35	36	38	40	43	46
	45	42	41	40	39	39	40	41	43	45	48
	50	47	46	44	44	43	44	45	46	48	50

(f) 135.1° to 167.5°

		Speed B									
		5	10	15	20	25	30	35	40	45	50
Speed A	5	9	14	19	24	29	34	39	44	49	54
	10	14	19	24	29	34	39	44	49	53	58
	15	19	24	29	33	38	43	48	53	58	63
	20	24	29	33	38	43	48	53	58	63	68
	25	29	34	38	43	48	53	58	63	67	72
	30	34	39	43	48	53	58	62	67	72	77
	35	39	44	48	53	58	62	67	72	77	82
	40	44	49	53	58	63	67	72	77	82	87
	45	49	53	58	63	67	72	77	82	87	92
	50	54	58	63	68	72	77	82	87	92	96

(g) 167.6° to 180°

		Speed B									
		5	10	15	20	25	30	35	40	45	50
Speed A	5	9	14	19	24	29	34	39	44	49	54
	10	14	19	24	29	34	39	44	49	54	59
	15	19	24	29	34	39	44	49	54	59	64
	20	24	29	34	39	44	49	54	59	64	69
	25	29	34	39	44	49	54	59	64	69	74
	30	34	39	44	49	54	59	64	69	74	79
	35	39	44	49	54	59	64	69	74	79	84
	40	44	49	54	59	64	69	74	79	84	89
	45	49	54	59	64	69	74	79	84	89	94
	50	54	59	64	69	74	79	84	89	94	99

station.) The vector wind difference mentioned in Figure 1-42, line 10, is obtained from Tables 29a through g.

Step 1. Determine the absolute angular difference between two winds on opposite sides of a front approximately 50 nm apart (e.g., Wind A = 03011, wind B = 11019, Difference = 110 - 30 = 80°).

Step 2. Select the table that corresponds to the angular difference (Table 1-29d: 77.6° to 102.5°).

Step 3. Enter the table and apply wind speed A and B (round to the nearest 5 knots). Vector difference is the intersection of Speed A and B (e.g., Speed A = 11 rounded to 10 knots. Speed B = 19 rounded to 20 knots. Vector difference is 22 knots).

Rules of thumb for low-level wind shear associated with a variety of meteorological causes are given below:

a. Cold Frontal Boundary. Low-level wind shear exists below 5,000 feet for up to 2 hours behind a fast-moving front. The potential persists until the depth of the cold air reaches the gradient level.

b. Warm Frontal Boundary. Low-level wind shear exists below 5,000 feet for up to 6 hours ahead of a surface front; it terminates with warm front passage. Pilot Reports (PIREPs) are invaluable for forecasting low-level wind shear in warm front situations. Strong vertical wind shears are usually accompanied by turbulence when the shear occurs in a (thermally) stable air mass.

c. Low-level Inversions. Shear occurs in these inversions with a light surface wind and a strong gradient level (2,000 feet) wind. Always look for strong winds aloft (from skew-T) when an inversion forms or is forecast to form. This frequently occurs under stable air mass conditions; usually at night, early morning, or evening, when the isobaric gradient supports strong winds (see surface analysis or prognosis).

d. Thunderstorm Gust Front. Cold outflows from thunderstorms form a mesoscale frontal boundary around the base of the storm, especially in its direction of movement. Wind speeds and directions are variable and hard to predict.

e. Low-level Jet. Low-level jets are bands of air in the boundary layer which are flowing faster than the overall environmental wind. They occur in all areas of the world at all times of the year.

- They are especially common in the United States Central Plains states in summer, mostly during night or early morning hours.

- A low-level jet wind speed profile is typically calm to 8 knots at the surface with a speed increase to 25 to 40 knots or more at about 650 to 1,500 feet above ground level. Speed then decreases with height above 1,500 feet to approach the gradient level wind speed of 15 to 30 knots.

- They occur above very stable air; the core of the jet is just above the top of the inversion layer.

- Other favored areas include:

- Desert coastal regions, especially in coastal areas with cold upwelling currents.

- Over equatorial upwelling currents.

- Border of heat troughs.

- Sharply defined zones of heavy rain (e.g., the backside of strong United States Midwest thunderstorms).

- The most extensive and intense low-level jets occur over the western Indian Ocean, southern Iraq and the Persian Gulf, during the Northern Hemisphere summer Indian monsoon.

- Extend from east of Madagascar across eastern Somalia to India.

- Speeds may exceed 60 knots at a core height of 5,000 feet.

- Low-level jets also occur along the west coast of South America, south of the equator, and in Namibia.

- Found between 800 feet and 5,000 feet in the tropics.

- May be 5,000 to 15,000 feet aloft in mountainous areas.

f. Mountain-wave conditions. Low-level wind shear often occurs above mountain tops when the wind component normal (perpendicular) to the top of the mountain range is 25 knots or greater and winds increase with height. They are accompanied by hazardous turbulence when the air above the mountaintop is stable.

g. Land and sea breezes. These produce gusty surface winds because of the differences in wind direction between the lower flow and the upper flow of the circulation.

D. FORECASTING GUSTY SURFACE WINDS IN THE UNITED STATES. High wind warning decision trees or flowcharts and features called “Notorious Wind Boxes” are discussed in this section. Local wind studies should be used to further supplement and refine these methods.

1. High Wind Warning Decision Flowcharts.

Decision flowcharts provide quick analyses of high wind potential using a few key, readily accessible upper-air parameters. The NWS developed Figures 1-42 and 1-43. Although these flowcharts were developed primarily for use in particular locations in the United States, they may be modified for use in other areas.

Figure 1-42 is used in the northeastern United States to forecast 35 knots or greater lasting for an extended period. High winds in the flowchart are defined as sustained winds of 35 knots or greater or wind gusting to 50 knots or greater persisting for more than 1 hour. Results may be adjusted to agree with local weather warning criteria. The method primarily uses thermodynamic and dynamic parameters from the surface to 850 mb. Winds and negative vorticity advection (NVA) are considered near the level of non-divergence (500-mb product used to approximate this level). Figure 1-43 is similar to Figure 1-42, except it is used in northern Texas in winter and spring for the first 12- and 24-hour forecast period. *Note:* The 12-hour FOUS NGM forecast geostrophic wind numerical output can be used to predict low-level boundary layer winds. If 45 knots are predicted, or are observed upstream and likely to move into the forecast area, then the first step of the chart is satisfied and continue with the remainder of the flowchart.

2. Notorious Wind Boxes. “Notorious Wind Boxes,” shown in Figure 1-44, are well known areas of strong wind-gust patterns (over 35 knots) in the continental United States. Of course, winds over 35 knots may occur in areas not included in these boxes. Wind boxes for ten different geographic areas are discussed in general terms below. More detailed information on wind boxes can be found in AWS/TR 219, *Forecasting Gusty Surface Winds in the Continental United States*.

a. Pacific Northwest. The Pacific Northwest box (western Washington, western Oregon, and extreme northwestern corner of California) is located within some major storm tracks. When large-scale storm systems move through the Eastern Pacific on a course toward the Pacific Coast between 40°N and 50°N latitude, strong winds begin within the box shortly before the arrival of the system and continue for periods of up to 24 hours, depending on the strength and movement of the storm.

- Rules for predicting maximum gust speed in an approaching low-pressure system.

- Compute the pressure difference (mb) across a 180 NM line from coastal to inland stations.

- Multiply the pressure difference by five to determine potential maximum gust (in knots).

- Time the onset of winds to coincide with the arrival of the outermost closed isobar of the low over the coastline.

- Rules for predicting maximum gust speed in approaching cold front.

- Requires a deep low to the northwest, high zonal west to east flow aloft and at the surface.

- The long-wave pattern normally shows either zonal flow or a long-wave trough near 130°W.

- Compute the pressure difference across a 180 NM line (e.g., between the stations KUIL and KRBL).

- Multiply the pressure difference by five to compute peak gusts (in knots).

- Time of onset of winds is when the front is within 200 NM of the coast.

- Normal wind duration is approximately 12 to 18 hours.

- Winds do not usually exceed 50 knots.

- The direction of the maximum gusts is usually in the range from southeast through west.

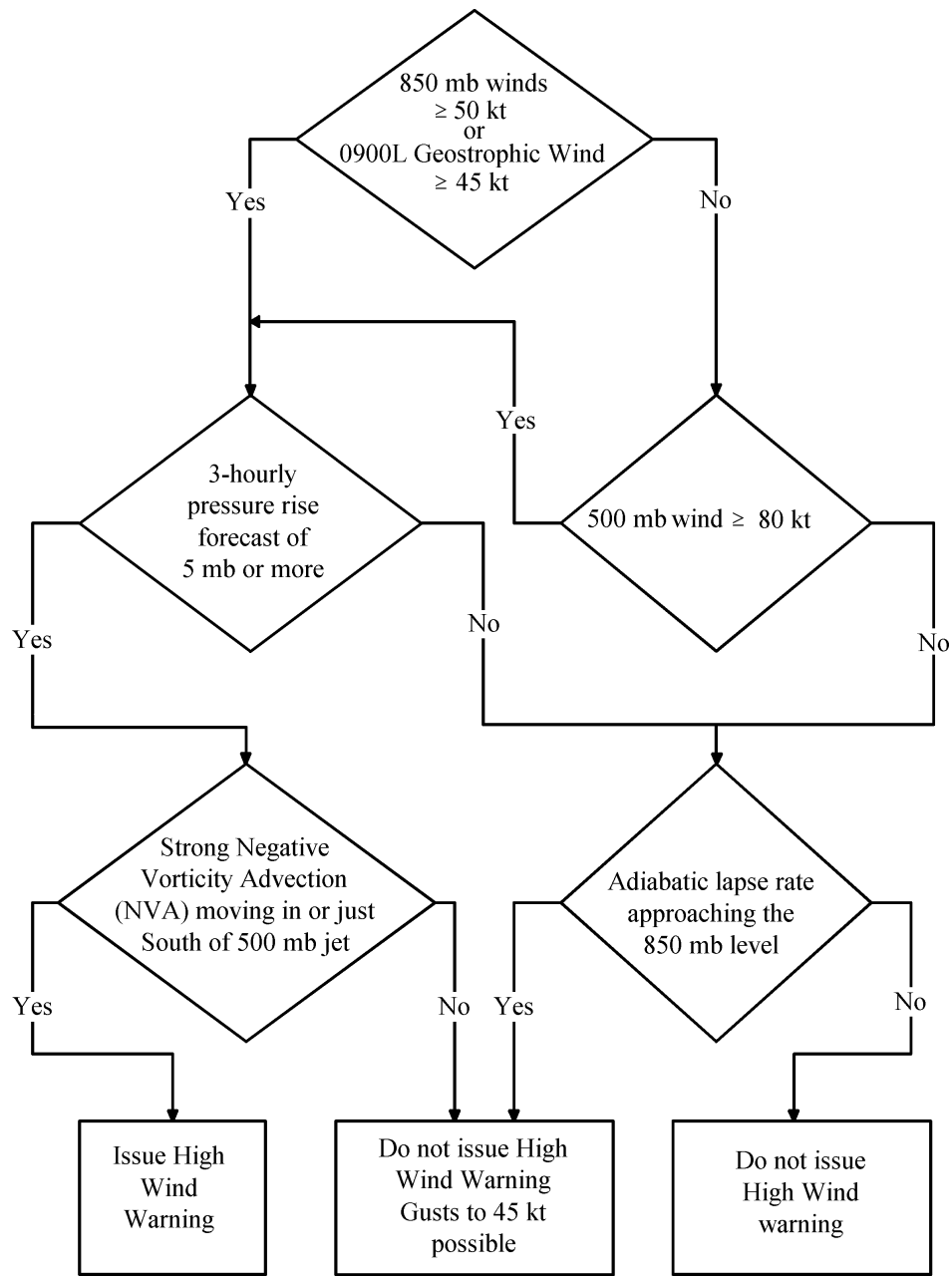

Figure 1-42. High Wind Warning Decision Tree for the Northeast United States. Use to forecast sustained wind 35 knots or greater or gusts to 50 knots or greater for more than 1 hour.

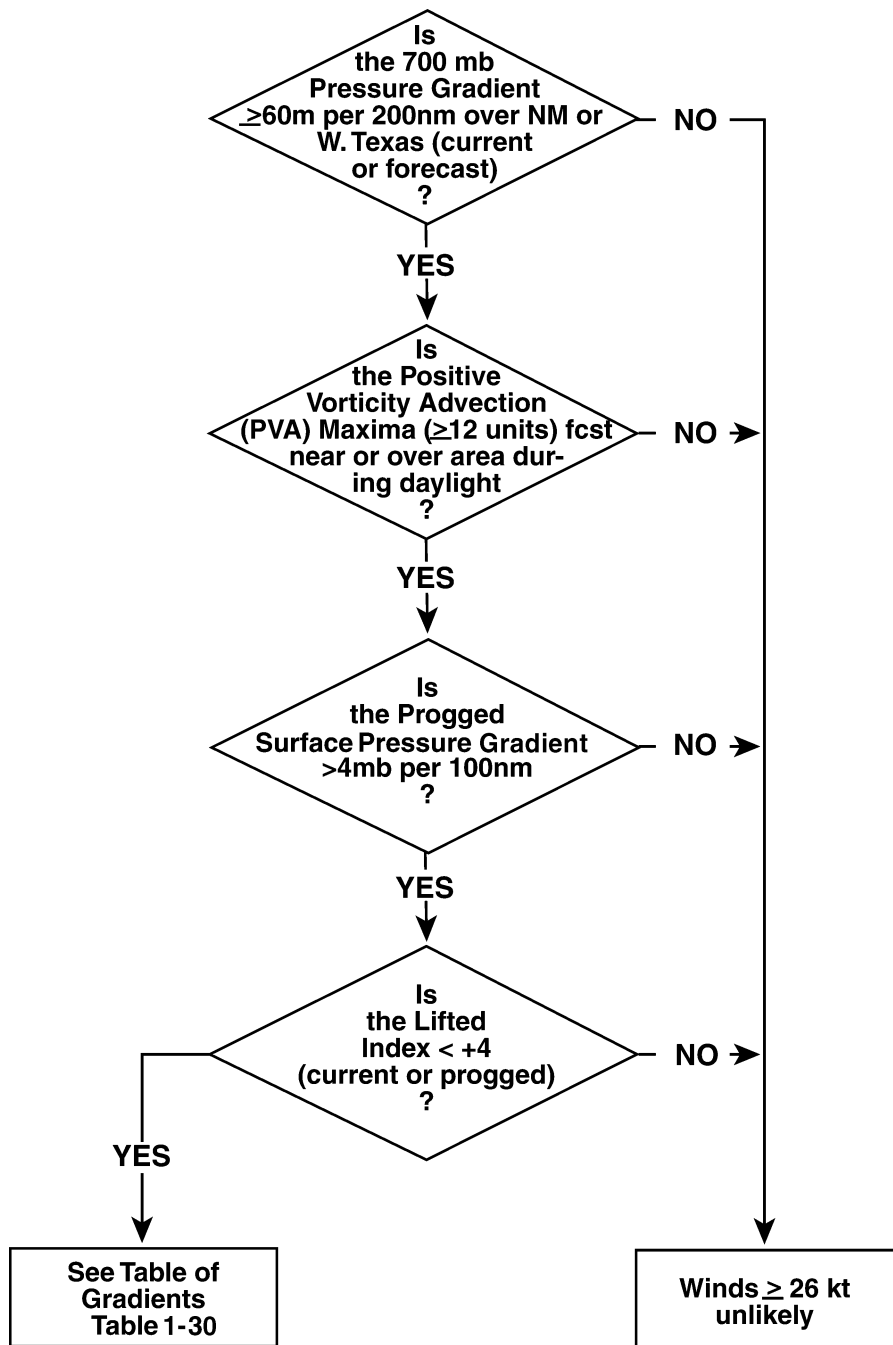

Figure 1-43. High Wind Warning Decision Tree for North Texas. This figure is similar to Figure 1-42 except it is used in northern Texas in winter and spring for the first 12- and 24-hour forecast period.

Table 1-30. Table of gradients (700 mb) used in conjunction with Figure 1-44.

200 NM Gradient	Best Wind Forecast
< 20 m	4 - 13 kt
20 - 29 m	9 - 18 kt
30 - 34 m	11 - 19 kt
35 - 39 m	12 - 21 kt
40 - 49 m	13 - 22 kt
50 - 59 m	18 - 26 kt
*60 - 69 m	22 - 31 kt (gusts to 35 kt)
*70 - 79 m	26 - 35 kt (gusts to 44 kt)
*80 - 89 m	31 - 35 kt (gusts to 48kt)
*90 - 99 m	35 - 44 kt (gusts to 53 kt)

*Involves strong, deepening cyclones moving through the area with no thick clouds and Lifted Index (LI) less than or equal to +4.

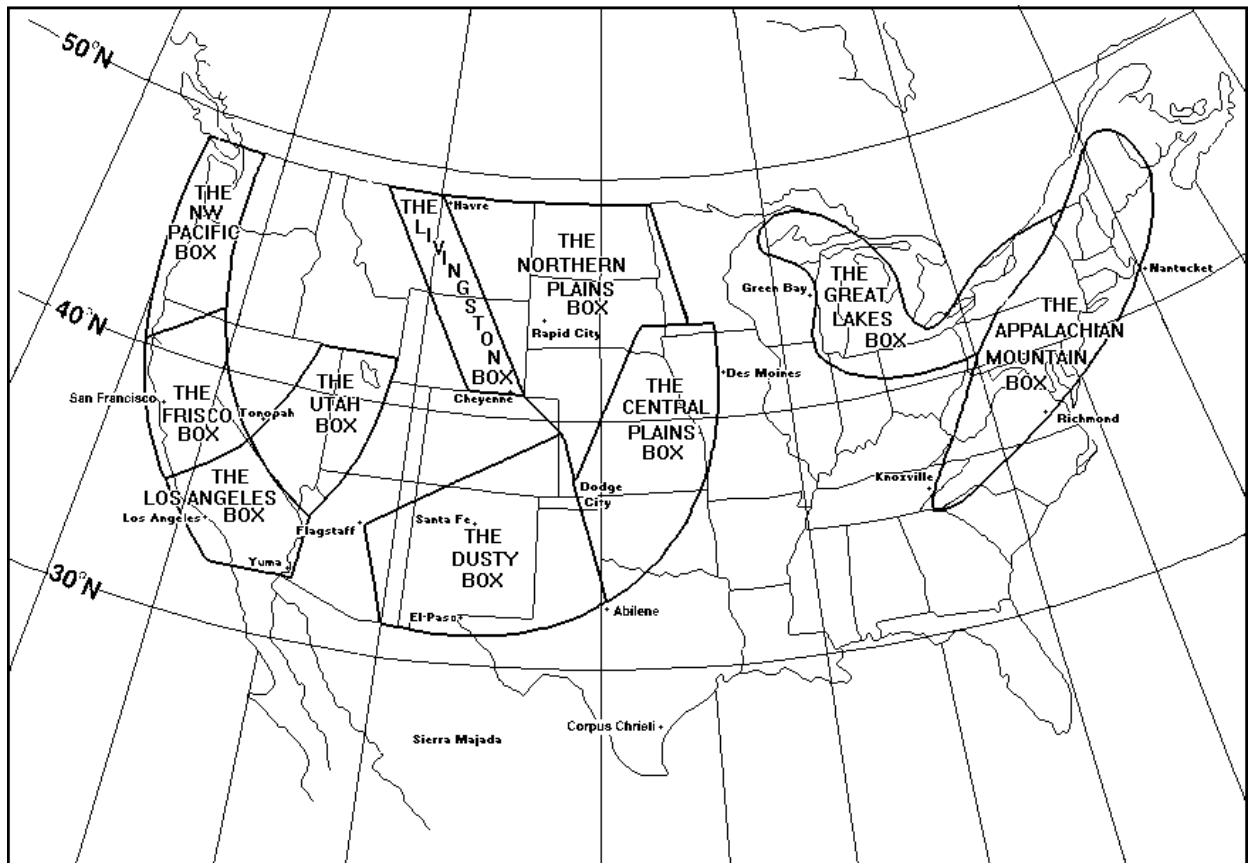

Figure 1-44. Location of “Notorious Wind Boxes.” The Figure shows well-known areas of strong wind-gust patterns (over 35 knots) in the continental United States.

Chapter 1

- On rare occasions, north winds occur with the passage of strong, cold-advection systems.

b. Frisco. These winds (northern half of California, excluding extreme northwest) are triggered by storms which move onto the West Coast between 35°N and 45°N, and often overlap the southern portion of the Northwest Pacific box.

- Low pressure with a tight gradient must be accompanied by southwest winds.

- Track 12-hour surface pressure falls to forecast the approach of a low-pressure system.

- Average gusts usually equal the maximum speed found in the low-level wind field.

- Peak surface gusts can exceed 50 knots if the low is strong and moving rapidly.

- Speeds usually remain below 50 knots; they may reach 65 knots if the system is strong and moving rapidly.

- Direction of gusts range from the southeast through the southwest.

- Northwest winds occur occasionally when 500-mb cold pools move northwest from the Cascade Range to the Sierra Nevada Mountains in the southeast. This pattern is similar to the Los Angeles Box described below; the main difference is the 500-mb cold pool tracks slightly west.

c. Los Angeles. The Los Angeles Box (southern half of California) is small and complex. It is associated with three different named winds: the Newhall, the Santa Ana, and the Mojave winds. Each of these winds blows from a different direction and is triggered by lows which move onto the West Coast between 30°N and 40°N. All three winds are adiabatic, downslope winds blowing in mountainous terrain in Southern California. These winds cause severe to extreme mountain-wave turbulence and a windy, drying effect.

- Newhall Winds.

- Blow through the Newhall Pass into the San Fernando Valley and rarely exceed 50 knots.

- The 500-mb cold pool's direction and movement are the best predictands used to forecast northwesterly surface wind gusts over California. Timing of the beginning of these winds should be based on the passage of the midlevel trough with certain allowances made for the time of day and regional influences, such as topography.

- Santa Ana Winds.

- Blow from the northeast and often exceed 50 knots.

- Can be produced by the rapid repositioning of long-wave features.

- Can also be produced by strong southward-digging, short-wave troughs that rapidly (in 24 to 36 hours) change the upper airflow from a westerly to northeasterly direction in Southern California.

- Mojave Winds.

- Blow from the southwest over the mountains and into the Mojave Desert.

- Similar to characteristics of the winds in the Utah Box described below.

d. Utah. Winds in this box (eastern Nevada, western Utah, and extreme northwestern Arizona) are associated with synoptic storms that move through Nevada near 40°N and track easterly. Winds blow from the south to southwest, and gusts usually do not exceed 45 knots. The Utah Box and the Mojave winds (Los Angeles Box) often overlap.

- The low-pressure system must be moving from the northwest through west with a low-level jet greater than or equal to 35 knots blowing from the southwest.

- Average gusts usually equal the maximum speed found in the low-level wind field.

- Strongest winds will occur inside the 35-knot isotach area on the low-level wind field.

e. Livingston. These winds (central Montana and central Wyoming) are caused by strong flow over the rugged mountains of Montana and Wyoming that produce adiabatic, downslope winds along the leeside (chinook winds). The gusts are triggered by low-pressure systems moving along three different storm tracks.

- Under southwest flow aloft, the box is activated by the same storms that trigger the Northwest Pacific and Frisco boxes.

- In near-zonal westerly flow aloft, winds are triggered by lows that move eastward between 45°N and 55°N.

- For northwest flow aloft, the box is activated by storms moving into the Northern Plains.

- Perform an isotach analysis of low- and midlevel wind fields.

- Identify maximum wind bands.

- Maximum gusts equal 50 percent of the strongest midlevel or 100 percent of the low-level winds.

- Expect possible severe to extreme mountain wave turbulence with gusts to 35 knots or more.

- Another method for determining peak gust involves computing the average of the mid- and low-level wind speed maxima.

- A stationary long-wave ridge above the box prevents triggering.

- Gust directions range between south-southwest and west-northwest.

- Wind speeds do not normally exceed 50 knots. Terrain channeling may increase speeds over 70 knots.

f. Dusty. Strong winds are generated throughout the Dusty Box (eastern Arizona, New Mexico, southeastern Colorado, northwestern Texas, extreme southwestern Kansas) by winter and spring storms moving eastward between 30°N and 40°N.

- Heavy blowing dust (visibility less than 5/16 NM) is normally confined to eastern New Mexico and Colorado.

- Wind direction ranges from south-southwest to west-northwest.

- Wind speeds exceed 60 knots when:

- The pressure in the approaching storm is less than 1000 mb.

- The storm is west of 115°W longitude.

- The storm is deepening as it moves eastward.

- During unusually dry years, speeds approach 100 knots and heavy blowing or suspended dust may reach 95° W from Kansas to central Texas. In addition, dust may be picked up from plowed fields off the plains.

g. Northern Plains. The Northern Plains Box (eastern Montana, northeastern Wyoming, North Dakota, South Dakota, western Nebraska) is caused by southeast-moving storm centers which cross the Canadian border between Montana and Minnesota.

- Rules for maximum gusts with low passage in the northern United States and southern Canada:

- Track surface pressure falls ahead of system.

- Strongest winds usually stay to the west of the low-pressure system.

- Surface wind gusts approach the maximum speed found in the low-level wind field.

- Rules for maximum gust with secondary cold front or trough passage.

- Track 12-hour surface pressure rises behind the front.

- Maximum gusts occur to the east of the pressure rise center movement.

Chapter 1

- Onset of winds in the box can be expected to coincide with rise centers crossing the Canadian border.

- Maximum surface gusts can exceed the maximum low-level wind values when combined with strong to moderate cold-air advection.

- The triggering mechanism is the passage of a cold front. The gusts begin in a secondary surge of cold air, when the rise center of the 12-hour surface-pressure change crosses the border.

- Wind speeds rarely exceed 50 knots.

- The Northern Plains Box often overlaps portions of the Central Plains Box.

h. Central Plains. The Central Plains Box (eastern Nebraska, Kansas, central Oklahoma) is a southerly-wind box caused by tightening of the surface-pressure gradient by storms moving through the Rockies.

- Flow is southwesterly from high pressure over the eastern United States, coupled with low pressure to the west or in the Northern Plains.

- Peak surface wind gusts equal the strength of the maximum wind in the low-level wind field.

- Surface gusts to 35 knots or more are usually contained within the area outlined by the 35-knot isotach in the low-level wind field.

- Strong winds depend on surface heating, so clouds and precipitation normally inhibit large 35-knot outbreaks, although the low-level jet stream may be quite strong.

- If low clouds are present, low-level winds must exceed 50 knots to produce surface gusts to 35 knots.

- The box may be activated a day early if, under clear skies, the pressure falls associated with an approaching storm are enhanced by a leeside effect. This produces a stronger gradient between the rapidly falling pressures to the west of the area and the smaller pressure falls to the east.

- Wind speeds do not normally exceed 45 knots, but may exceed 60 knots for a dry storm that has a central pressure below 1,000 mb when it reaches eastern Colorado.

- Sometimes this box overlaps the eastern portion of the Northern Plains Box.

i. Great Lakes. The Great Lakes Box is activated by cold fronts or storm centers passing near the Great Lakes on a northeasterly, easterly, or southeasterly course.

- Rules for maximum gust with strong cold fronts (north-northwesterly winds, northwest-southeast isobaric pattern).

- Compute pressure difference along a 400 NM axis.

- Each mb of pressure difference equals 3 knots of wind speed. A difference of 11 mb equates to 35 knots.

- For north-south isobaric patterns, see the Appalachian Box. For other isobaric patterns, do not expect gusty winds.

- Rules for maximum gust with strong cold front (northwest winds, north-south isobaric pattern).

- Compute pressure difference along a 240 NM axis.

- Each millibar equals 3 knots wind speed.

- Wind speeds normally are less than 45 knots, except for when exceptionally strong storms pass the Great Lakes.

- Wind directions may vary when associated with northeasterly moving storms.

- Wind directions for southeasterly moving storms and cold frontal passage range from west-southwest in the lower-portion to north in the upper-portion.

- Wind gusts usually are less than 45 knots,

except when very strong storms pass the Great Lakes.

j. Appalachian Mountain. This box occurs with lows moving southeast and cold fronts.

- Rules for maximum gust with strong cold front (northwest winds, N-S isobaric pattern).

- The Great Lakes Box and the Appalachian Mountains Box frequently overlap.

Note: Forecasting higher speed winds depends on accurately forecasting the position and deepening of the Hatteras Low.

- Wind in the box may be from the northeast quadrant and exceed 60 knots for a Hatteras Low.

E ADDITIONAL REGIONAL WIND FORECASTING GUIDANCE.

1. Korea.

- Southwest winds greater than 35 knots seldom occur during the winter; southwest winds of 15 to 25 knots ahead of a cold front are common.

- Lows that deepen in the Sea of Japan (East Sea) tighten the pressure gradient over the Korean peninsula and cause 25 to 30 knots with occasional gusts to 35 knots for 8 to 10 hours.

- Strong northwesterly to northerly surface winds at 25 to 30 knots, with occasional gusts to 35 knots, usually occur after a cold frontal passage when the 850-mb isotherm gradient is greater than 10°C/150 NM; 20- to 30-knot winds can be expected with a gradient of 5°C/100 NM.

- Land and sea breeze. Make prediction at 0000Z (09L). Note the wind direction, estimate the wind speed, and determine the maximum temperature at your location. If the last three of the following conditions apply, consider forecasting a land or sea breeze:

- Determine today's minimum land temperature required for a land/sea breeze using either Table 1-31 or the sea surface temperature plus 3.5°F. Call this T_L (Table 1-31 gives a climatological estimate for T_L).

- Determine the maximum temperature (°C) expected today. Call this T_{Max} .

- T_{Max} greater than or equal to T_L .

- Wind direction at 0000Z is from land to sea, or is calm.

- Wind speed at 0000Z less than or equal to 9 knots.

2. Japan.

a. Northern.

- If the 850-mb winds are greater than 50 knots and the surface to 850-mb lapse rate is greater than 10°C, anticipate winds with gusts greater than 35 knots.

- Winter northwest winds reach a maximum about 6 hours after a trough or low passage. This delay is due to damming of cold behind the mountains before spilling over.

- During late winter through early summer, expect winds more than 50 knots if an occlusion, followed by a strong high, moves through the Sea

Table 1-31. Minimum land temperatures (°C) required for a land/sea breeze formation. This table uses the monthly mean sea surface temperature (SST) plus 3.5°C.

Coastal Areas	Jan	Feb	Mar	Apr	May	Jun	Jul	Aug	Sep	Oct	Nov	Dec
Southern ROK. Kunsan AB	9	9	10	13	16	20	24	28	25	21	16	11
Central ROK. Osan AB, Camp Humphreys, Yongsan AIN, Seoul AB, Koon-Ni Range	7	7	9	11	15	20	23	28	25	21	15	11

Chapter 1

of Japan between 45° and 35°N and 135° and 145°E.

- A sea breeze occurs progressively earlier as the summer advances, usually starting 1000 to 1100L in April and May and 0700 to 0800L in August and September.

- A high to the east intensifies the sea breeze.

b. Central.

- Kanto lows are a common cause of strong southerly winds in the Kanto Plain. These lows result from a combination of terrain (leeside), solar insolation, and sea-breeze effects. The lows form under clear or mostly clear skies and are usually located in a mountain valley northwest of the Kanto Plain during afternoon hours.

- Forecast Kanto Low winds to begin by 0900L if the gradient wind has a southerly component; by 1200L if a weak gradient wind exists; by 1400L if a weak northerly gradient exists.

- Do not forecast gusty surface winds with a Kanto Low:

- After a 24-hour isallobaric high center has passed east of the area.

- When a surface inversion is present or forecast to occur.

- In winter.

- Land breeze rules (near coast):

- During the winter, the land breeze is enhanced over the local area and produces 20 to 33 knots from sunset until late evening.

- With 20 to 33 knots northerly winds during the day, land breeze reinforcement produces over 35 knot winds from sunset to near midnight.

- Sea breeze rules:

- During the period mid-May through mid-October, the sea breeze generally becomes established by late morning and dissipates by early/mid-evening.

- With development of a strong Kanto Low, the sea breeze generally sets in by 0900 to 1000L with 20 to 33 knots by mid-afternoon along the coast.

- Once the low-level inversion dissipates, moderate to strong southwesterly to westerly flow at 3,000 feet over the Kanto Plain produces surface wind speeds equal to 80 to 90 percent of the 3,000-foot winds.

- Topography influences surface winds to be either north-northeast or southeast-southwest over 90 percent of the time. Winds from other directions are weak except when a 700-mb trough axis with strong cold-air advection passes. Such a scenario produces west-northwest winds more than 20 knots for several hours.

- Moderate northerly winds with gusts to 30 knots occur when the Siberian High is well developed and located over eastern Asia, and a well-developed low is located to the southeast or east. This condition persists until the low moves to the east.

- Tropical cyclones:

- A tropical cyclone or deep low passing to the west and north in the Sea of Japan tends to cause gusty southerly winds.

- Southerly winds and fair weather occur in the Kanto Plain as a tropical cyclone moves through the Sea of Japan.

c. Southern.

- Gusty surface winds from the northwest persist in the northern areas of Kyushu for 24 to 36 hours after a cold front passes in the fall, winter, or spring.

- Rapidly deepening cyclones forming off the east coast of the Japanese islands can cause 20- to 30-knot northeast winds across northern Kyushu.

- Sea breezes begin when the land-sea temperature difference is greater than 1.5°C to 3°C.

- Tropical Cyclones:

- If a typhoon passes to the west of Kyushu around a Bonin High, strong winds occur with light rain.

- Typhoons more than 120 NM away causes fair weather and no gusty winds.

3. *Okinawa and the Ryukyu Islands.*

- Post-frontal gusty surface winds can be significant.

- Surface wind intensity varies with the width of cloud bands. Narrow bands may contain convective showers, move rapidly, and are frequently associated with cold surges. The bands are usually accompanied by gusts to 45 knots. Wide, slower-moving weather bands may be accompanied by gusts that seldom exceed 35 knots.

- Between November and March, surface wind gusts of 30 to 35 knots are often observed 2- to 6-hours in advance of a cold front and frequently persist 30 to 36 hours after the front passes. With a strong front, expect gusts of 35 to 45 knots.

- In April, May, June, and October, gusts with a cold frontal passage are 25 to 30 knots. With weak fronts, expect maximum gusts of 20 to 25 knots.

- During Siberian high outbreaks, forecast surface winds of at least 20 knots gusting to 35 knots at frontal passage; gusts in a second surge may occasionally reach more than 40 knots 1 to 2 hours after frontal passage.

- Summer winds are usually southerly (south-southeast through south-southwest) and are light and variable from sunset to sunrise. They increase during the early morning to 12 to 18 knots and continue at these speeds until about 1700L.

4. *Hawaii.*

- Winds are either predominant trade winds or sea breezes. If the trade winds are less than 10 knots at 6,000 feet, then the sea breeze dominates.

- The trades are normally lightest in the morning and reach their peak by mid-afternoon.

- The diurnal variation of surface wind speeds is far less pronounced during strong trade wind flow; nighttime gusts often equal those of the afternoon.

- During periods of high winds, the time of the maximum wind is more dependent upon changes in the pressure gradient than diurnal considerations.

- When a local 24-hour pressure rise begins, a new surge of the trades begins within 24 hours. The greater the rise, the stronger the wind speeds. This is especially true if pressures continue to rise during the afternoon diurnal pressure fall.

- During a Kona Low, the normal trade wind flow is reversed. Winds over the island chain comes from a southerly direction, windward areas become the leeward areas and vice versa. This southerly wind is stronger and gustier than normal.

- Strong northwest to north winds occur 6 to 12 hours after frontal passages from October to May. This occurs when the primary low center associated with the front is located south of 40°N moving in an easterly direction or there is an active wave on the front.

- Easterly waves cause 15- to 20-knot winds with occasional 30-knot gusts.

- Use the flowchart in Figure 1-45 to forecast peak tradewind gusts. Modify parameter values for other locations.

5. *Guam.*

- Rainy Season: Winds greater than 25 knots occur less frequently in the rainy season but are difficult to forecast. The following parameters contribute to surface winds greater than 25 knots:

- Maximum wind gust potential is from rain showers or thunder showers. One hundred percent of maximum wind speed to the gradient level (3,000 feet) plus speed of cell movement (e.g., 15 knots at 30° + 10 knots movement = 25 knots).

- Radar: Is the speed of cells increasing? Is the diameter of individual cells greater than 5NM?

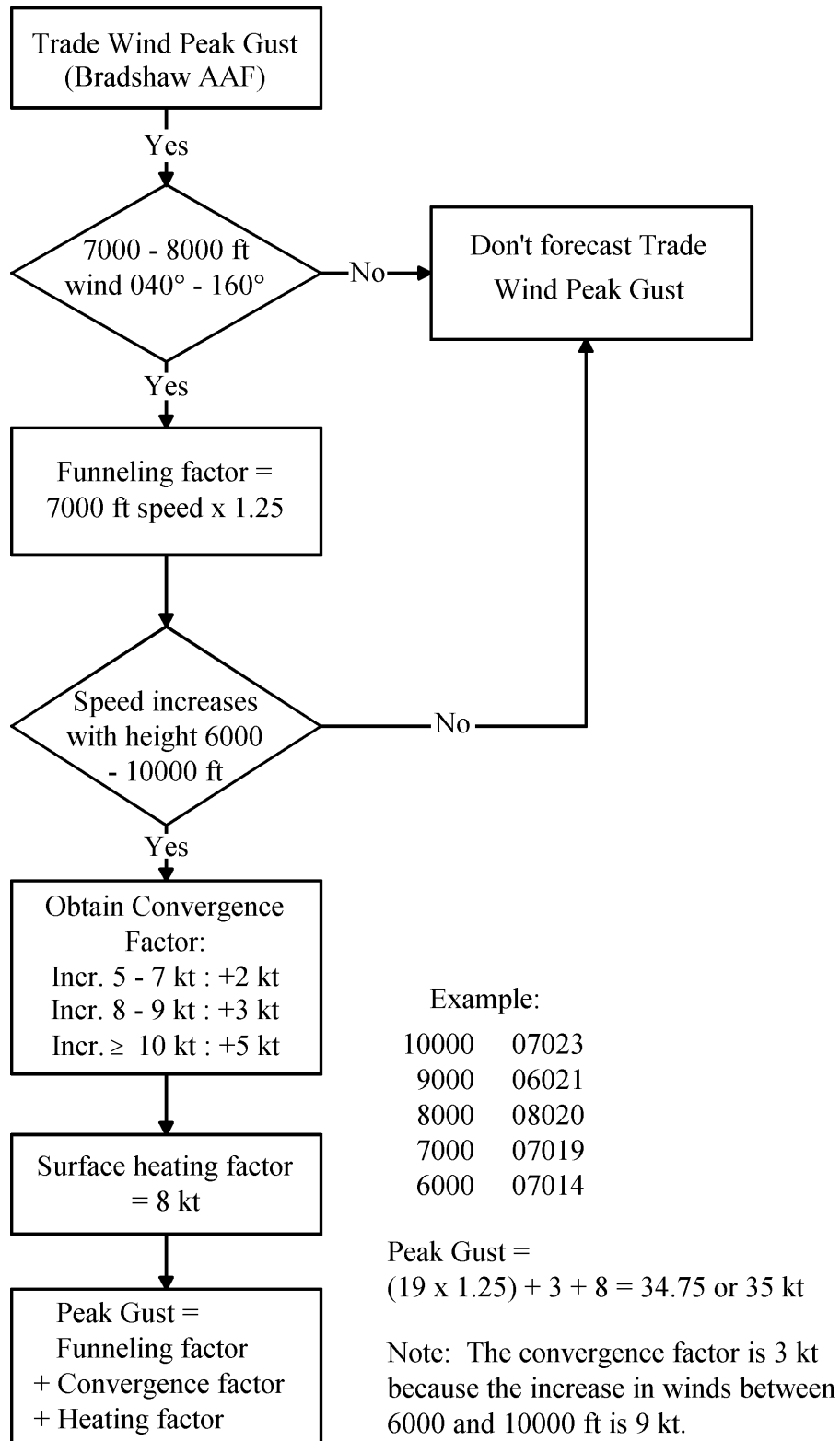

Figure 1-45. Bradshaw AAF, Hawaii Trade Wind Peak Gust Flowchart. Use the flowchart to forecast peak tradewind gusts. Modify parameter values for other locations.

- Is a dry slot present in the lower 10,000 feet? This feature accelerates downrush due to dry air entrainment. Is the slot greater than a 5°C depression? Are winds backing in the vertical? A true dry slot has backing winds.

- Is the sounding not saturated? Saturation yields lower winds.

- Is the monsoon trough/southwest surge over Andersen? Stronger winds are present in and just south of the trough axis.

- Dry Season: Most incidents of 25-knot winds occur when the gradient level winds increase, due to either a shear line or an approaching tropical wave. Usually a shower occurs, but not always. The following parameters contribute to surface winds greater than or equal to 25 knots:

- Radar Analysis: Is the speed of movement increasing? Are down rush patterns present? These are indicated by cells developing and dying rapidly, with development in front of dying cells in relation to movement. Is a wave formation approaching? This is indicated by a clear area followed by north-south lines of showers (perpendicular to the flow) approaching from the east. Is a shear line formation approaching? This is indicated by east-west lines (parallel to the flow) of showers/ clouds approaching from the northwest.

- Maximum Outflow Wind Gust Potential: 80 percent of maximum wind speed up to the gradient level (3,000 feet) (e.g., 30 knots x 80 percent = 24 knots).

- Guam National Weather Service office has two rules of thumb: If the maximum low-level wind speed is below 3,000 feet, maximum gust is equal to 100 percent of that wind speed. Sustained winds equal 70 percent of the maximum wind speed up to 3,000 feet.

6. Europe. The occurrence of extreme wind conditions over Europe affects flying, paratroop, amphibious, and river-crossing operations, and even communications equipment. This section on European wind conditions focuses only on winds that are unusual or severe. Figure 1-46 is a geographic summary of major winds discussed in this section.

a. North Atlantic. North Atlantic gales form when well-developed cyclones approach the British Isles or occasionally from open wave frontal systems. A gale has mean wind speeds of at least 34 knots and gusts of at least 43 knots.

- Cyclones forced to move south by well-developed highs over Scandinavia produce strong gales through the English Channel, the North Sea, and surrounding coastal areas.



Figure 1-46. Major Wind Systems and Local Names for European Winds. The figure provides a geographic summary of major winds.

Chapter 1

- Gale winds can blow from any direction, but are usually strongest from the northwest.
- Hurricane force (64 knots) gales are usually confined to open water.
- Gales occur from fall through spring, but are less common in the spring. They are rare during the summer.

b. Northern Europe. Bora winds are cold, dry northeasterly gale-force, gravity-assisted, drainage winds which blow down from the mountains (The term “bora,” originally applied to Yugoslavian winds, is now used in other parts of the world). They form when cold air over a snow-covered, elevated plateau is forced down by strong horizontal pressure gradient forces associated with the approach and passage of intense cyclones from the North Atlantic. Though adiabatic warming does occur during the descent, the air is still quite cold when it arrives at lower elevations. In Northern Europe, these winds most frequently affect the Northern and Western coasts of Scandinavia, such as the Norwegian fjords. Considerable damage can occur when these winds blow over relatively narrow and unprotected peninsulas and lowlands. Mistral winds are similar to boras, but are less violent and descend the western mountains into the Rhone Valley of France and into the Mediterranean.

- Boras occur mainly during the winter with a clear, cold high over the interior of Europe.
- Narrow valleys or canyons channel the winds to cause speeds over 100 knots.
- Weak bora winds may also occur along an open coast.

c. Central Plains. This area is located in northeast France and northern Germany. Cyclones passing through the English Channel or over the North Sea cause strong southerly or southwesterly winds over much of the lowland areas of this part of Europe. Wind speeds often exceed 40 knots. Considerable channeling of bora winds in deep river valleys may cause considerable damage.

- Upslope & Lee Effect Charts. The former 5th Weather Wing published a forecaster memo

called, “A Guide for Using Upslope and Lee Effect Charts.” This publication describes acetate overlays used with Global Navigation Charts (GNC 4) for central Europe. These acetates show main areas of extended cloudiness with low ceilings due to orographic lifting of air masses flowing toward mountain barriers, and the areas of cloud dissipation on the lee side of those barriers. A limited number of sets of overlays are available from the AFWTL.

d. Alpine Region. The foehn is particularly strong and extremely gusty in certain valleys in Europe known as “foehn channels.” In the Alpine region, there are two types of Foehn winds: the southerly foehn on the north slopes, and the northerly foehn on the south slopes.

- The frequency of foehns depends upon the number and the relative strengths of the migratory lows associated with these winds.

- Foehns are common during the spring, summer seasons in Europe, and occur frequently (30 to 50 times a year) between Geneva, Switzerland and Salzburg, Austria.

- Southerly Foehn: Figure 1-47 shows a typical synoptic situation for a southerly foehn. These prefrontal warm sector foehns are a signal of an approaching cold spell from north of the Alps.

- Northerly Foehn: The northern foehn is felt in the valleys on the Italian side of the Alps. It occurs when air from the north descends into mountain valleys, flowing into the Po River valley.

- Occur more frequently than the southerly Foehn.

- Adiabatic warming is much less dramatic than the southerly foehn because it starts from a relatively cold area.

- Foehns can also be triggered by the subsidence beneath anticyclones.

- Anticyclonic foehns are usually dry.

- Anticyclone foehns occur frequently over the Alps in winter due to persistent ridging in the area.

- Extended periods of anticyclonic foehns gradually melt snow cover even in higher terrain. They are often associated with snow-drought winters in the Alps.

e. Balkans and Eastern Europe. See USAFETAC/TN-93/004, *Eastern Europe, A Climatological Study*, for comprehensive coverage of these winds.

7. Mediterranean and North Africa. Many of the same wind systems affect large areas of this region and are discussed by type and area. These wind types on the Mediterranean coasts are the etesian, sirocco, bora, and mistral.

a. Etesian Winds. These winds occur in the eastern Mediterranean and blow uniformly from the north. They flow toward the center of the Indian monsoonal trough over Iran, Afghanistan, and northwestern India. Figure 1-48 shows a typical synoptic situation for etesian winds.

- These winds dominate the wind flow over the Adriatic, Ionian, Aegean Seas, the Levant,

Greece, and to a certain extent, parts of the Middle East. They may be felt as far east as the Caspian Sea and Turkestan.

- They constitute the most constant and steady flow known on the European continent.

- They start around mid-May and last until mid-September.

- Breaks, particularly in July, are usual in northern areas.

- Winds reach their greatest strength in the early afternoon and often weaken or disappear during the night.

- Forecast 34 to 47 knots etesian winds when a strong upper ridge is forecast over France and a strong upper trough is forecast over the Ionian Sea, northern Greece and the eastern Balkans.

- Forecast a gale force etesian when cyclogenesis occurs over Southwest Asia and anticyclogenesis occurs over the Balkans. The

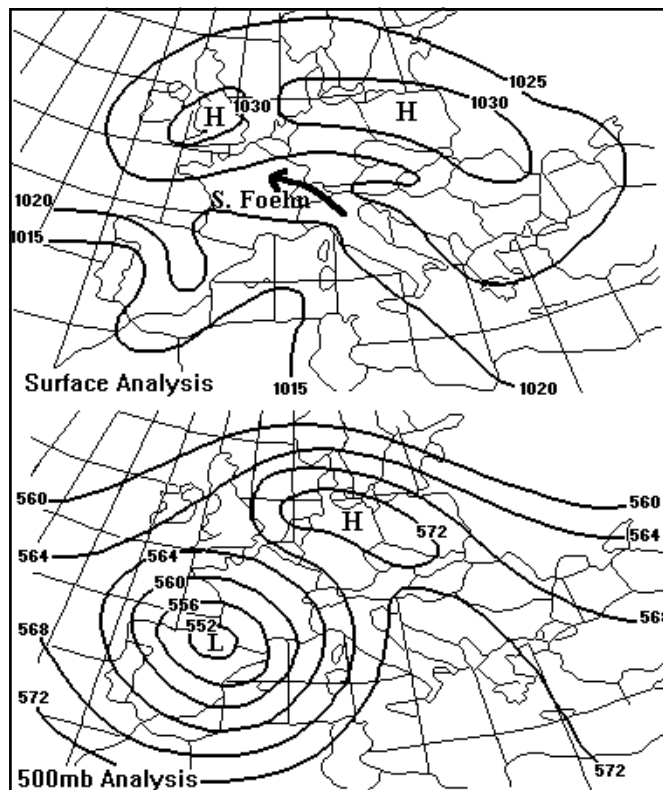

Figure 1-47. Southerly Foehn in the European Alpine Region. Typical synoptic situation.

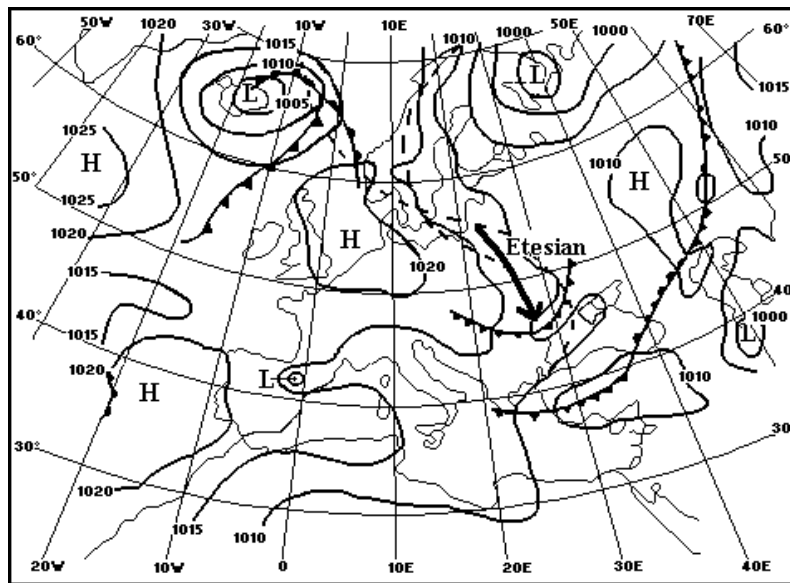

Figure 1-48. Typical Synoptic Situation Causing an Etesian Wind.
 These winds occur in the eastern Mediterranean and blow uniformly from the north.

movement southward or southeastward of a cold front is needed to establish a gale force etesian. Forecast the end of gale force winds when a 500-mb ridge is expected over the southern Ionian Sea.

- The mistral and etesian occur out of phase: if one prevails, the other does not. Therefore, if the onset of mistral conditions looks to occur, the gale force etesian should end.

- An extended etesian is likely if there is a deep surface low in the Black Sea region and a closed low at 500 mb. Strong northerly winds prevail at upper levels over the Aegean Sea.

- A blocking long-wave ridge over France and western Germany is associated with extended etesian periods of 5 days or more.

b. Sirocco. The word sirocco, also spelled scirocco, means “east” and “to dry up.” The derivations show the desert origin and the dryness of these southerly and southeasterly winds. These winds carry a great deal of dust into Europe. After crossing the Mediterranean Sea, these winds reach the coast as a moist wind and are responsible for

the formation of low stratus clouds. Weather associated with the sirocco shows marked variations from southwest to the northeast across the Mediterranean and is very dependent upon the trajectory of the air mass. See Figure 1-49 for a typical synoptic situation associated with a sirocco.

- Genuine siroccos are extremely hot in summer and relatively warm in winter, a direct result of the seasonal variation of desert temperatures.

- Relative humidity at the point-of-origin can be as low as 8 percent.

- They usually last a day or two; their depth averages 6,000 to 7,000 feet (1,829 to 2,134 meters).

- Dust carries above 13,000 feet in unstable air over the desert.

- Their frequency and seasonal distribution seem to be directly related to the number of eastbound Mediterranean disturbances.

- The western Mediterranean experiences about 50 per year, with the number increasing eastward.

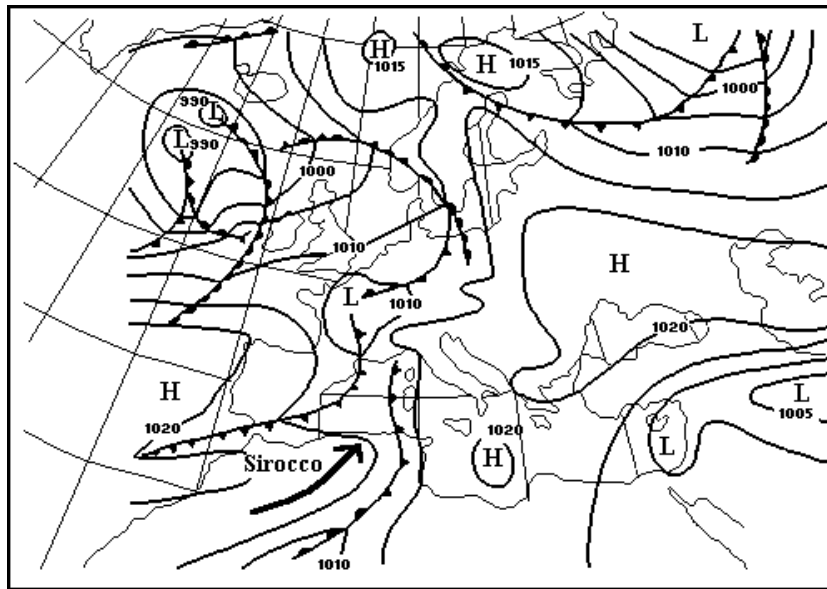

Figure 1-49. Typical Synoptic Situation Associated with a Sirocco.
These dry, southerly winds carry large amounts of dust to Europe.

- Occurs primarily in spring in Europe. Southerly tracking lows are more frequent then and the temperature contrasts between the warm sector and the maritime polar air behind the cold fronts are more pronounced than in autumn.

- Siroccos are uncommon in summer. This is due to a smaller number of lows and storm tracks that are restricted to the northernmost parts of the Mediterranean.

- A good indication of the start of a sirocco in the eastern Mediterranean is the development of strong southerly winds at stations along the northeast coast of Libya.

- A low-level jet is likely just below the top of the very marked temperature inversion common during the sirocco. Winds reaching 80 knots with strong turbulence and wind shear can occur.

- Diurnal variations of the sirocco at coastal locations can be expected if its direction coincides with that of the sea breeze. The sea breeze

enhancement of the sirocco during the afternoon is likely to subside quickly in the evening.

- For the central Mediterranean, forecast a strong sirocco when: an upper trough is present over the Balkans with a strong jet stream along its southern boundary; and large pressure falls (removing diurnal effects) occur at stations along the east coast of Tunisia.

- During a sirocco, dense belts of altocumulus castellanus approaching from the southwest, probably associated with weak upper troughs, are at times associated with radical and sudden changes in wind speed and direction.

c. Bora. The eastern Mediterranean bora forms in the same way as the Northern European bora. The cold winds flow down to the eastern coast of the Adriatic Sea. Sometimes they are very localized, extending only a few miles seaward from the coast of Yugoslavia, other times they cover the entire Adriatic. Bora-type winds are found in the Aegean Sea extending southward across the Mediterranean

Chapter 1

to Crete. This far southern extent is usually a cyclonic bora, associated with an intense low that has moved eastward across the Ionian Sea. Figure 1-50a shows the typical synoptic situation associated with a cyclonic bora in the Adriatic Sea.

- Clouds, rain, and wind usually accompany boras associated with a low over the Adriatic.

- Bora winds are much weaker where mountains are lower than 2,300 feet (700 meters) or where lowlands are located more than 2 to 3 miles (3 to 5 km) inland.

- Average velocity of a well-developed bora is about 70 knots, with potential gusts to 115 knots. Strongest winds are along the eastern shore of the Adriatic from Trieste to the Albanian border. Cyclonic boras are more common over the open sea and the strongest winds are 37 to 47 knots over the southern Adriatic.

- Bora winds are most frequent between 0700 and 0800L and the less frequent at 1400L.

- Winds commonly last for 3 to 4 days; however, several weeks' duration is possible.

- With the cyclonic bora with a depression just south of the Adriatic, low clouds with drizzle and/or rain reduces visibility over the Adriatic.

- Weather depends primarily on the depth of the northerly or northeasterly flow. When the flow is shallow (5,000 feet or less) low clouds and rain with low visibility are common. This is also the case when a cyclone is located just to the south. If accompanied by deep northerly or northeasterly flow, the skies are generally clear.

- These boras occur most frequently in winter, when temperature and pressure gradients between the Serbian highlands and the Adriatic are greatest.

The Adriatic region also experiences anticyclonic boras. Characteristics of the anticyclonic bora (see Figure 1-50b) include the following:

- Winds blow from the northeast quadrant.

- Extreme gustiness, especially in passes and gaps.

- Very dry, relative humidity sometimes as low as 15 percent.

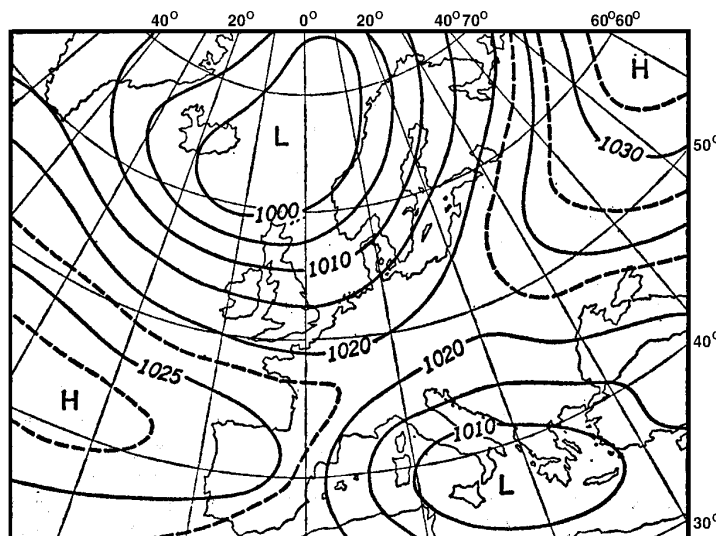

Figure 1-50a. Typical Synoptic Situation Associated with a Cyclonic Bora in the Adriatic Sea. Bora-type winds are found in the Aegean Sea extending southward across the Mediterranean to Crete.

- Fair skies with a wall of cumulus clouds over mountain ridges.

Consider the following information when forecasting bora conditions.

- Forecast a bora along the coast when high pressure is predicted to build over the Balkans. Forecast it over the Adriatic Sea when high pressure is expected to build over the Balkans and a surface low is forecast to move southeast from the Gulf of Genoa to the northern Ionian Sea.

- During an extended period of bora conditions, the passage of secondary cold fronts are often associated with sudden wind increases to 33 to 47 knots.

- For a cold outbreak to occur over the Aegean Sea within 48 hours, a ridge at 500 mb over the eastern North Atlantic occurs as well as a trough at 500 mb over central Europe.

- Forecast a cold outbreak over the Aegean Sea with the arrival or development of a high cell over the Balkans. During winter, the high is likely to be located over Scotland 48 hours before the frontal passage. During fall, the high develops over the Balkans 24 hours before frontal passage.

- Eastward movement of a surface cyclone across the Aegean Sea initiates a cold outbreak. This low is of primary importance during spring.

- Gale force northwesterlies occur if the cold air is deep (greater than 5,000 feet). Shallow cold air does not extend south of Crete and, therefore, does not affect the eastern Mediterranean.

- Forecast the end of bora conditions over the Adriatic when high pressure over the Balkans is predicted to weaken or move or with the disappearance of the well-defined foehn wall cloud over the Dinaric Alps seen in satellite imagery, and the increase of low clouds over the Adriatic Sea.

d. Mistral. Western Mediterranean mistrals are associated with upper-level (500 mb) flow from the northwest through northeast. This flow allows cold air to exit southern France and enter the western Mediterranean. Diurnal variation in intensity at coastal stations show the maximum winds occur in the afternoon; over the sea they tend to occur at night.

- Forecast the start within 48 hours when: the upper-level pattern shows a long-wave ridge axis west of Iceland and strong upper-level troughing is expected over eastern Europe into the central Mediterranean, and a surface frontal trough located

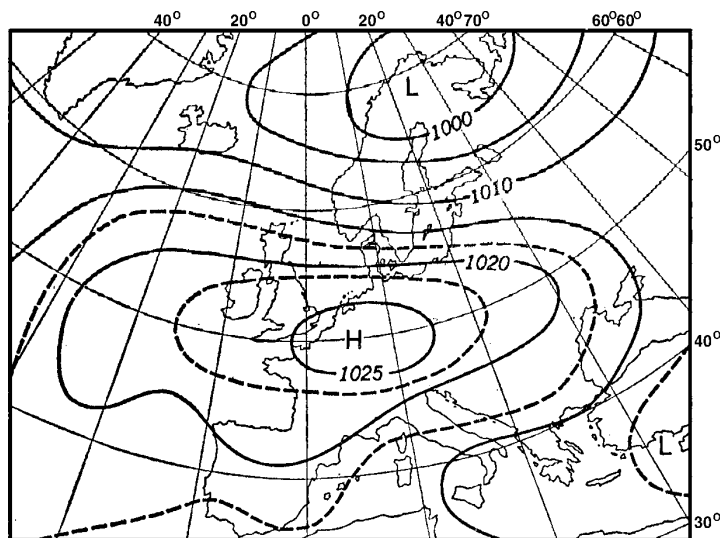

Figure 1-50b. Typical Synoptic Situation Associated with an Anticyclonic Bora in the Adriatic Sea. These boras occur most frequently in winter, when temperature and pressure gradients between the Serbian highlands and the Adriatic are greatest.

Chapter 1

just south of Iceland is backed by an extremely strong surge of cold air to the east of Greenland.

- The mistral begins with one of three pressure differences:

- 3 mb between Perpignan to Marseille/Marignane.

- 3 mb between Marseille/Marignane to Nice.

- 6 mb between Perpignan to Nice.

Note: A pressure difference usually occurs from 0 to 24 hours after a closed Genoa low appears, but it occasionally occurs earlier.

- Strongest winds do not occur until after the passage of the 500-mb trough.

- Strong mistral winds that occur on the cyclonic side of and under the jet axis extend as far south or southeast as do the trough and jet stream.

- The mistral ceases when the cyclonic flow at the surface gives way to anticyclonic flow. Indications are: surface wind direction becomes north to northeast, 500-mb ridge begins to move over the area from the west or north, high pressure at the surface begins to move into the western basin of the Mediterranean.

IV. TEMPERATURE. Temperature forecasts are some of the most common weather forecast requests. The temperature can have a greater influence on ground operations and daily life than any other single element on a routine basis. The most commonly required temperature forecasts are for maximums and minimums, post-frontal conditions, and critical temperatures for wind chills and heat stress. Many variables influence temperature changes, e.g., insolation, radiation, mixing, advection, convection, and adiabatic processes. This chapter covers specific techniques to help forecast this important surface weather element.

A. GENERAL TEMPERATURE FORECAST TOOLS.

1. Climatology. Climatology is a common method used for forecasting temperatures. In most locations, decades worth of weather data are used to derive the climatology. This climatology, or weather trends over a period, is an important ingredient to temperature forecasting. Several sources for climatological data are available from the Air Force Combat Climatology Center (AFCCC), including the following:

a. Conditional Climatology (CC) Tables. The CC Tables display monthly and annual climatology data to include the maximum, mean, and minimum diurnal temperature curves. Factors such as wind direction, cloud cover, and month are integrated into the climatological studies.

b. International Station Meteorological Climate Summary (ISMCS). ISMCS is a jointly developed USN/NOAA/USAF CD-format climatological tool that contains station climatic summaries.

c. Station Climatic Summaries. These are regional collections of individual station climatic summaries for seven major geographical areas. These summaries normally include monthly and annual climatic data for temperature means and extremes, daily, and monthly highs/lows, and dew point temperatures.

d. Modeled Curves (MODCURVES). MODCURVES is a computer program that uses climatology as a guide to provide the temperature baseline for the time of year and time of day. The display can be adjusted to meet current or expected weather conditions that affect temperature forecasts (i.e., cloud cover, winds).

e. Surface Observation Climatic Summaries (SOCS). Part E of the SOCS includes temperature, dry-bulb, wet-bulb, dew point, and relative humidity information for specific bases and posts for over an extended period. A station must have 5 years of recorded observations to have a SOCS.

Note: These aids are available at most weather stations, but can be ordered through the Air Force Combat Climatology Center (AFCCC), if needed.

2. Model Output Statistics (MOS). MOS guidance is an excellent tool to help forecast temperatures. MOS guidance derives its forecasting relationships by correlating past model output with station climatology. It is imperative to initialize and verify the model before using its MOS.

a. Maximum/Minimum Temperatures (MX/MN). View displayed guidance for projections of 24, 36, and 48 hours after the initial data time (0000 UTC or 1200 UTC).

b. Hourly Temperatures (TEMP). Time-specific, two-meter temperature forecasts are valid every 3 hours from 6 to 60 hours after 0000 and 1200 UTC. Two meters is the height of most temperature measuring instruments, so it is used in the computations.

c. Limitations of the NGM MOS. Use MOS as a guide for forecasting temperature, but be aware of these limitations: Climatology is an essential ingredient, so if synoptic conditions are abnormal for that time of year, MOS guidance may be biased towards climatology. In other words, MOS does not forecast extreme or record temperatures well. Maximum temperature forecasts show a marked warm bias in midwinter synoptic situations with a shallow cold air mass near the surface. This is frequently found in the Rockies in association with intrusions of intense, but shallow, arctic air masses on the high plains east of the continental divide. It also occurs in regions of trapped cold air in high valleys in the western United States.

d. Modifying NGM MOS Temperature Forecasts. Meteorologists at Kavouras have developed an extensive list of rules of thumb for modifying MOS temperature forecasts when the MOS guidance may be in error under certain conditions.

- Minimum temperatures too cold under warm advection. In a warm advection situation at

night, the MOS minimum temperature is usually significantly under forecast in cases of strong warm advection ahead of a front. This error may be 3° to 5°C (5° to 10°F).

- Warm sector temperatures too cool ahead of cold fronts. Often the rate of warming just ahead of a cold front is under forecast. A narrow tongue of warm air is often pulled northward in advance of the cold front, and actual temperatures may be 1° to 4°C (3° to 6°F) warmer than the MOS forecast.

- Minimum temperature forecasts too warm with clear/calm conditions. Under ideal radiational cooling conditions, MOS may not fully account for the conditions and forecast the minimum temperature to be too warm.

- Maximum temperatures are forecast to be too warm under low-level cold air. Under cold outbreaks, maximum temperatures are often over forecast. This often occurs in the plains with arctic outbreaks and along the East Coast under easterly flow. The NGM direct model output forecast temperatures is better than MOS in these situations.

- Abnormal surface conditions affect temperatures. During the summer months when the soil is very dry, observed temperatures are warmer than the MOS forecast. When the soil is very wet, readings are lower than MOS. Fresh snow cover during the winter months can lead to colder day and night readings than given by the MOS forecast, though recent improvements have decreased this error.

- Abnormal temperature ranges impact MOS forecasts. MOS has difficulty in predicting extremely anomalous conditions. Rarely does MOS forecast a record-breaking event.

- MOS longer-range forecasts trend towards normal. MOS forecasts trend toward normal (climatological averages) with increasing projection of the forecast. During prolonged periods of heat or cold, MOS forecasts often indicate cooling or warming towards the normal at the latter forecast periods.

3. *AFWA Trajectory Forecast Bulletins.*

Trajectory forecasts produced by AFWA (Air Force Weather Agency) can help pinpoint the origin and properties of air parcels. This product helps account for the effects of advection on the temperature forecast.

- Advect the air parcel to your station by using the initial position, movement, and properties of the air parcel, and interpolate the effects of the conditions on your local weather. Note the observed flow at the initial and the end point. Interpolate between them and estimate the curvature and path of the parcel.

- Use the lowest pressure level on the trajectory model output (2,000 feet above ground level) to forecast temperature. Adjust this temperature based on the adiabatic lapse rate of 1.0°C per 100 meters (5.5°F per 1,000 feet) to the station elevation. If the air mass is saturated, use the moist adiabatic lapse rate of 0.5°C per 100 meters (3.0°F per 1,000 feet.)

Note: The trajectory display program determines if the lowest pressure level is below station elevation; if so, a slash (/) is entered for forecast temperatures and dew points. If the 850-mb or 700-mb level is above station elevation, adjust those temperatures and dew points adiabatically for use as a surface forecast.

Disadvantages: Trajectory forecasts do not consider changes in temperature or moisture except for adiabatic contributions. For example, it does not consider cooling and moistening (by evaporation) of cool air parcels passing over warm bodies of water. Also, it does not take into consideration the influences of topography.

4. Persistence. Persistence often works well for forecasting temperatures. Simply take high and low temperatures from the previous day and compare the current synoptic situation with that of the previous day. If there have been no changes in either the air mass or the general weather (clouds, winds, etc.), forecast the previous day temperatures to recur. This technique works accurately from day to day until changes do occur.

5. Extrapolation. This technique refers to the

forecasting of a weather pattern feature based solely on recent past motions of that feature. To use extrapolation techniques in short-range forecasting, it is necessary to be familiar with the positions of fronts and pressure systems, their direction and speed of movement, precipitation and cloud patterns that might affect the local terminal, and the upper-level flow that affects the movement of these weather patterns.

Step 1. Determine the air mass that is over the region during the forecast time of interest.

Step 2a. *Maximum temperature forecasting.* Check the high temperatures in that air mass for the preceding days.

Step 2b. *Minimum temperature forecasting.* Check the low temperatures in that air mass for the preceding nights.

Step 3. Account for adiabatic changes. If the air is rising (upslope trajectory), subtract 1° to 3°C (3.0° to 5.5°F) (based on moist or dry adiabatic lapse rate) for every 1,000 feet of ascent to allow for adiabatic cooling of the parcel as it rises. If the flow is downslope, add 1° to 3°C (3.0° to 5.5°F) (moist or dry) for the corresponding descent.

Step 4. Remember to allow for modifications of the air mass, such as expected cloud cover, winds, and precipitation.

6. Temperature Forecasting Checklist. As with all meteorological parameters, temperature forecasting is easier when a routine approach is employed. Figure 1-51 is an example of a typical temperature-forecasting checklist. Add other key items that work well.

B. FORECASTING MAX TEMPERATURES.

1. Within an Air Mass. Use the following steps to forecast maximum temperatures:

Step 1. Examine the current analysis and prognosis products to determine the source of the air mass expected over the station at verification time. Select a station 24 hours upstream and use its previous day's maximum temperature as a first guess for the forecast.

TEMPERATURE GUIDE			
CLIMATOLOGY	EXTREME	MAX _____	MIN _____
	AVERAGE	MAX _____	MIN _____
YESTERDAY'S		MAX _____	MIN _____
FRONTAL PASSING		YES _____	NO _____
NWS CHART (or equivalent)		MAX _____	MIN _____
MOS BULLETIN (or equivalent)		MAX _____	MIN _____
REPRESENTATIVE SKEW-T		MAX _____ AT _____	MIN _____ AT _____
YOUR FORECAST		MAX _____ AT _____	MIN _____ AT _____

Figure 1-51. Sample Temperature Forecasting Checklist. Add other key items that work well.

Step 2. Modify the first estimate for adiabatic effects by determining the elevation difference between the two stations.

Step 3. Make a cloud cover forecast for the station, compare it to the cloud cover at the upstream station, and determine the difference in effects of insolation. Use diurnal temperature curves that consider cloud cover (such as MODCURVES) to make a final temperature forecast.

2. Using the Skew-T, Log P Diagram. Use the Skew-T, Log P diagram to forecast the day's high temperature. Use the early morning sounding, if the sounding is representative of the air mass expected during hours of maximum heating. If the sounding is not representative, adjust it and create a forecast sounding. Make adjustments based on expected cloud cover, approaching frontal systems, and inversions present as described below:

a. Clear to Scattered Sky Conditions.

Step 1. Follow the dry adiabat from the 850 mb or 5,000-foot temperature down to the surface. Use 700 mb if the station elevation is above the 850-mb level.

Step 2. Read the temperature at the surface

as a good estimate of the afternoon maximum temperature if little or no cloud cover develops.

Note: In Europe, north of the Alps, this method only works from mid-March through mid-September.

b. Broken to Overcast Sky conditions.

Step 1. Follow the moist adiabat from the 850 mb or 5,000-foot temperature to the surface. Use 700 mb if the station elevation is above the 850-mb level.

Step 2. Read the temperature at the surface to approximate the afternoon maximum temperature.

c. When a Warm Front Approaches.

Step 1. Forecast an 850-mb temperature (700 mb if located above the 850-mb level), considering temperature advection at that level.

Step 2. Follow the dry adiabat from the 850 mb or 5,000-foot temperature down to the surface. Use 700 mb if the station elevation is above the 850-mb level.

Step 3. Read the temperature at the surface as a good first-guess at the afternoon maximum temperature.

d. When a Low-level Inversion is Present. This method is most effective under cloud-free or scattered sky conditions in late spring or early autumn.

Step 1. Use the top of a nocturnal surface inversion (warmest part of the inversion).

Step 2. Follow the dry adiabat to the surface.

Step 3. Read the temperature at the surface as an estimate of the afternoon maximum temperature.

C. MINIMUM TEMPERATURE FORECASTS.

1. Using the Skew-T, Log P Diagram. One method to forecast the minimum temperature is by following the moist adiabat passing through the 850-mb dew point temperature to the surface. This method requires an unchanging air mass from the time of the sounding to the forecast valid time. Use a forecast sounding if atmospheric changes are expected. Use 700 mb if station elevation is above the 850-mb level.

2. Using Dew Point. Use the dew point at the time of the maximum temperature as a forecast minimum temperature for the following night. If skies are clear and winds are calm, minimum temperatures may be 2° to 4°C (4° to 7°F) lower than the afternoon dew point from September through March at all stations located on flat terrain or valley floors. This technique does not take into account air mass changes.

3. After Cold Frontal Passage. Forecast the coldest minimum temperature the second morning after a cold front passes. This rule works well when the typical cold front is considered. A cold front passes during the afternoon, and cold advection starts with the shift of the wind to northwest. Cold-air advection continues through the night and into the next day. At minimum temperature time, the north wind is still blowing, but at a lower speed than earlier. Cold advection continues during the

second day, but it is not as strong. By the second morning, the high is centered near or over the station. With little wind and little or no temperature advection, the minimum temperature is colder than the morning before. During the second day, the high moves east and warm advection begins. The third morning's minimum temperature is generally warmer than the second.

4. Craddock's Minimum Temperature Formula.

J. M. Craddock and D. Pritchard conducted a study to improve minimum temperature and fog forecasting in England in the 1950s. An Air Force forecaster, MSgt Roger L. Lowe, adjusted and updated the formula for current use. This technique works well, but is restricted to a stagnant air mass and used in addition to other tools. The modified formula in °F is as follows:

$$T_{\min} = 0.32 T + 0.55 T_d + 2.12 + C$$

where: T = 1200 UTC temperature

T_d = 1200 UTC dew point temperature

C = Determined from Table 1-32

Table 1-32. Craddock's minimum temperature parameter (in degrees F).

Mean Forecast Surface Wind	Mean Forecast Cloud Amount			
	0 - 2	3	4 - 5	6 - 8
< 10 kt	-3	-2	-1	0
≥ 10 kt	-1	0	0	+1

D. SOME ADDITIONAL RULES OF THUMB.

1. Forecasting with Limited Data. It is possible to make an accurate temperature forecast without the information available in most weather stations.

- Combine station and area climatology with a thorough knowledge of the local terrain and its effects on weather to understand physical processes controlling local weather.
- Obtain upper-air sounding data if possible.
- Some tips to consider if surface observations are the primary or only tool:

- Get out a piece of paper and plot hourly temperatures and dew points (time on the X-axis and temperature on the Y-axis) to establish station diurnal trend curves. It may take several days to establish a firm pattern, but this is an excellent limited-data, temperature-forecasting tool.

- Use the dew point at the time of the maximum temperature as the forecast minimum temperature for the next night if skies are primarily clear and no change in air mass is expected.

- Subtract the average diurnal variation for the month from the maximum temperature to estimate a minimum temperature when little change is expected in the cloud cover or air mass. Add it to the minimum temperature for estimating the maximum temperature.

- The moistness or the dryness of the ground affects heating of the ground. Solar radiation evaporates moisture in or on the ground first, before heating the surface. This inhibits the daytime maximum heating. A wet soil heats up and cools down much slower than a dry soil.

- Snow cover significantly affects daytime heating of the ground and, therefore, the air. Expect lower temperatures if there is snow cover. Air masses advected over an area with snow cover cool if the air mass is warmer than the ground. Snow reflects solar radiation and limits surface heating.

- Light winds allow for increased heating during the day. Wind speeds above 10 knots decrease the daily maximum temperature by 1°C (2°F) or more due to the turbulent mixing down of cooler air from aloft. For surface winds above 35 knots, the high temperature can be 3°C (5°F) lower.

- Moisture decreases the daily temperature range. For example, the spread between daily

maximum and minimum temperatures ranges from only 3° to 5°C (5° to 10°F) in a wet-season tropical forest to over 28°C (50°F) in interior deserts.

- Note pressure trends to help anticipate approaching fronts. Plotting hourly pressures allows diurnal pressure curves to be established. Large variations from the norm could indicate approaching frontal systems or pressure centers.

Note: AWS/FM-300/1, *Single Station Analysis and Forecasting*, contains trends and typical cloud types associated with approaching fronts.

2. High Winds and Cooling. High winds retard cooling due to turbulent mixing. At night, due to more rapid cooling of the air in the lowest levels, the air mixed down is warmer than air near the ground surface. One rule of thumb is to add 1°C (2°F) to the low temperature forecast if the winds are to be around 15 knots. Add up to 3°C (5°F) for winds of 35 knots or greater. This technique does not consider warm- or cold-air advection.

3. Humidity and Cooling. High relative humidity (80 percent or greater) in the low-levels may inhibit cooling, because moisture is an efficient long-wave heat trapper. A humid night may be 3°C (5°F) warmer than a drier night. This rule is especially important near a large body of water.

E. TEMPERATURE INDICES.

1. Temperature-Humidity Index (THI). To accurately express the comfort or discomfort caused by the air at various temperatures, it is necessary to take into account the amount of moisture present. The NWS uses the THI to gauge the impact of the environment on humans. The formula for completing the index follows:

$$THI = 0.4 (T + T_w) + 15.0$$

Table 1-33. Temperature-Humidity Index (THI) conditions.

THI °C (°F)	Conditions
22 (72)	Slightly uncomfortable conditions.
24 (75)	Discomfort becomes acute and most people would use air conditioners, if available.
> 26 (79)	Discomfort is general and air conditioning is highly desirable.

Note: This table was formulated in °F and includes °C as a reference only.

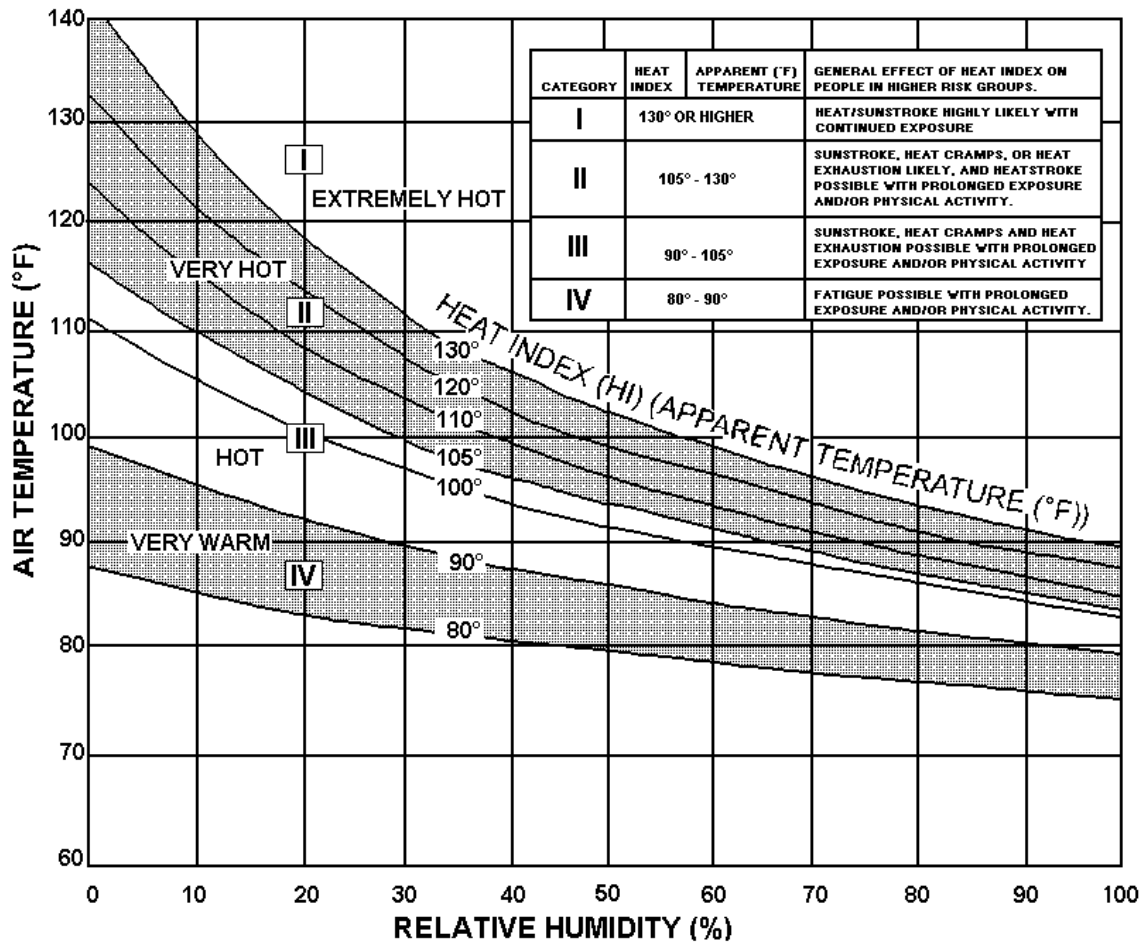

Figure 1-52. Heat Index. Enter this temperature/humidity nomogram with observed or forecast data to predict apparent temperature and effect on people.

where: T is the dry-bulb temperature and T_w is the wet-bulb temperature (both in °F). Use Table 1-33 to determine THI.

2. Heat Index. The heat index, also known as apparent temperature, is the result of extensive bioenvironmental studies. Determine the heat index by inputting air temperature and relative humidity into Figure 1-52. Like the THI, it considers the combined effects of high air temperatures and atmospheric moisture on human physiology.

3. Wet-Bulb Globe Temperature (WBGT) Heat Stress Index. The computation and dissemination of WBGT heat stress index information is not an Air Force Weather responsibility; medical personnel normally determine and provide such information. However, questions often arise during the summer months and it may benefit you to know the basic computation and information concerning the index.

According to the American Conference of Governmental Industrial Hygienists, the WBGT is “the most practical heat stress index characterizing the effect of heat stress environment on the individual.” Like the previous two indices, WBGT incorporates air temperature and atmospheric moisture. It also models the heat gain on the body by absorption of solar radiation by a thermometer enclosed in a black metal globe. To measure WBGT, special equipment is needed. For more information, refer to USAFETAC/TN-90/005, *Wet-bulb Globe Temperature, A Global Climatology*.

a Computing the WBGT Index. Compute the index by adding 70 percent of the wet-bulb temperature, 20 percent of the black-globe temperature, and 10 percent of the dry-bulb temperature. The formula is:

$$WBGT = 0.7 WB + 0.2 BG + 0.1 DB$$

Table 1-34. WBGT impact table. This table was formulated in °F and includes °C as a reference only.

WBGT °C (°F)	Water intake (quarts per hour)	Work/rest cycle (minutes)
28 - 29 (82 - 84.9)	at least 1/2	50/10
29 - 31 (85 - 87.9)	at least 1	45/15
31 - 32 (88 - 89.9)	at least 1 1/2	30/30
> 32 (> 90)	more than 2	20/40

where: WB = wet-bulb temperature in °F, BG = black-globe temperature in °F, DB = dry-bulb temperature in °F.

b. Effects of WBGT. AFP 160-1 provides detailed descriptions of how WBGT affects human performance and tells how to deal with those effects. Table 1-34 (extracted from Army FM 21-10) provides a guide to WBGT effects. However, heat casualties have occurred with WBGT values of 24°C (75°F), and even lower. AFM 105-4/FM 34-81,

Weather Support for Army Tactical Operations, lists WBGT values of more than 30°C (85°F) as a critical meteorological value for Army operations.

4. Fighter Index of Thermal Stress (FITS). This index is one of many used to support Air Force flying activities but may possibly be one of the most requested. It was developed by the former Tactical Air Command specifically for F-4 Phantom aircraft and uses the Heat Index Equation. This technique is best suited

		Humidity (%)								
		ZONE	10	20	30	40	50	60	70	80
Temperature (°F)	70		67	70	72	74	76	78	81	83
	75		71	74	77	79	82	84	86	88
	80		75	79	81	84	87	89	92	94
	85		79	83	86	89	92	95	97	99
	90		83	87	91	94	97	100	103	105
	95		87	92	96	99	102	105	108	111
	100	Caution ¹	91	96	100	104	108	111	114	117*
	105		95	100	105	109	113	116*	120*	122*
	110		99	105	110	114	118*	122*	125*	128*
	115	Danger ²	103	109	115	119*	124*	127*	130*	134*
120	107		114	119*	124*	129*	133*	136*	140*	

*When the FIT is greater than 115, consider canceling all nonessential flights.

¹. **Caution Zone.** Be aware of heat stress, limit ground time (preflight, cockpit standby) to 90 minutes, and have a minimum recovery time of at least 2 hours between flights.

². **Danger Zone.** Limit ground time to 45 minutes or less if possible, avoid more than one flight a day, low-level missions with temperatures in this zone are not advised and have a minimum recovery time of at least 2 hours between flights.

Figure 1-53. Fighter Index of Thermal Stress (FITS) Chart. Enter the figure with the local air temperature in °F and relative humidity. At the intersection, read the FITS value and determine the zone.

INDEX OF THERMAL STRESS (ITS)

Dry Bulb Temp (°F)	ZONE	DEWPOINT TEMPERATURE (°F)								
		30	40	50	60	70	80	90	100	≥110
70		70	73	76	81	86	X	X	X	X
75		74	77	80	84	89	X	X	X	X
80	Normal	77	80	83	87	92	98	X	X	X
85		81	83	86	90	95	101	X	X	X
90		84	87	90	93	98	104	110	X	X
95		88	90	93	96	101	108	112	X	X
100		91	93	96	99	104	109	115	122	X
105	Caution	94	96	99	102	107	112	118	124	X
110		97	99	102	105	109	114	120	126	133
115	Danger	100	102	105	109	112	117	123	129	136
120		104	105	108	111	115	120	125	131	138

Figure 1-54. Index of Thermal Stress (ITS) Chart. Insert dry-bulb and dew point temperatures into the figure and determine the zone. This index applies to only lightweight flight clothing. The X in the chart denotes combinations above saturation temperature.

EQUIVALENT CHILL POTENTIAL																				
WIND SPEED		TEMPERATURE (°F)																		
CALM	CALM	40	35	30	25	20	15	10	5	0	-5	-10	-15	-20	-25	-30	-35	-40	-45	-50
KNOTS MPH		EQUIVALENT CHILL TEMPERATURE																		
3-6	5	35	30	25	20	15	10	5	0	-5	-10	-15	-20	-25	-30	-35	-40	-45	-50	-55
7-10	10	30	20	15	10	5	0	-10	-15	-20	-25	-35	-40	-45	-50	-60	-65	-70	-75	-80
11-15	15	25	15	10	0	-5	-10	-20	-25	-30	-40	-45	-50	-60	-65	-70	-80	-85	-90	-100
16-19	20	20	10	5	0	-10	-15	-25	-30	-35	-45	-50	-60	-65	-75	-80	-85	-95	-100	-110
20-23	25	15	10	0	-5	-15	-20	-30	-35	-45	-50	-60	-65	-75	-80	-90	-95	-105	-110	-120
24-28	30	10	5	0	-10	-20	-25	-30	-40	-50	-55	-65	-70	-80	-85	-95	-100	-110	-115	-125
29-32	35	10	5	-5	-10	-20	-30	-35	-40	-50	-60	-65	-75	-80	-90	-100	-105	-115	-120	-130
33-36	40	10	0	-5	-15	-20	-30	-35	-45	-55	-60	-70	-75	-85	-95	-100	-110	-115	-125	-130
Winds above 40kt have little added effect		LITTLE DANGER			INCREASING DANGER (FLESH MAY FREEZE WITHIN 1 MINUTE)					GREAT DANGER (FLESH MAY FREEZE WITHIN 30 SECONDS)										

Figure 1-55a. Wind Chill Index Charts. Wind chill is shown in degrees Fahrenheit.

EQUIVALENT CHILL POTENTIAL																				
WIND SPEED		TEMPERATURE (°C)																		
CALM	CALM	4	2	-1	-4	-7	-9	-12	-15	-18	-21	-23	-26	-29	-32	-34	-37	-40	-43	-46
KNOTS MPH		EQUIVALENT CHILL TEMPERATURE																		
3-6	5	2	-1	-4	-7	-9	-12	-15	-18	-21	-23	-26	-29	-32	-34	-37	-40	-43	-46	-48
7-10	10	-1	-7	-9	-12	-15	-18	-23	-26	-29	-32	-37	-40	-43	-46	-51	-54	-57	-59	-62
11-15	15	-4	-9	-12	-18	-21	-23	-29	-32	-34	-40	-43	-46	-51	-54	-57	-62	-65	-68	-73
16-19	20	-7	-12	-15	-18	-23	-26	-32	-34	-37	-43	-46	-51	-54	-59	-62	-65	-71	-73	-79
20-23	25	-9	-12	-18	-21	-26	-29	-34	-37	-43	-46	-51	-54	-59	-62	-68	-71	-76	-79	-85
24-28	30	-12	-15	-18	-23	-29	-32	-34	-40	-46	-48	-54	-57	-62	-65	-71	-73	-79	-82	-87
29-32	35	-12	-15	-21	-23	-29	-34	-37	-40	-46	-51	-54	-59	-62	-68	-73	-76	-82	-85	-90
33-36	40	-12	-18	-21	-26	-29	-34	-37	-43	-48	-51	-57	-59	-65	-71	-73	-79	-82	-87	-90
Winds above 40kt have little added effect		LITTLE DANGER			INCREASING DANGER (FLESH MAY FREEZE WITHIN 1 MINUTE)					GREAT DANGER (FLESH MAY FREEZE WITHIN 30 SECONDS)										

Figure 1-55b. Wind Chill Index Charts. Wind chill is shown in degrees Celsius.

for predicting the effects of heat on personnel in lightweight flight suits (see Figure 1-53).

5. **Index of Thermal Stress (ITS).** The ITS is based on the Fighter Index of Thermal Stress (FITS), but is tailored for student pilots of the Air Education and Training Command (Figure 1-54).

a. **Caution Zone.** Be alert for symptoms of heat stress, drink plenty of noncaffeinated liquids, avoid exercise 4 hours prior to take off, and plan for a minimum of 2 hours between sorties (fighters and trainers only).

b. **Danger Zone.** In addition to the above procedures, limit ground operations to 45 minutes for fighter/trainer type aircraft (time outside of air-conditioned environment). As well, when possible, wait in a cool, shaded area if the aircraft is not ready to fly and complete a maximum of two aircraft inspections (two exterior inspections on initial sorties and one exterior inspection on subsequent sorties for fighters and trainers).

6. **Wind Chill.** Wind chill is a frequently requested parameters during the winter months. Windchill temperature combines the effects of low air temperatures with additional heat losses caused by the wind's removal of the warm layer of air

trapped in contact with skin. The faster the wind blows, the faster the layer of warm air is carried away. To calculate the forecast windchill temperature, enter the forecast temperature and the forecast wind speed into one of the charts shown in Figures 1-55a or 1-55b, or use the Observer Assistant Computer Aid (available from the AFWTL).

V. PRESSURE.

A. **GENERAL GUIDANCE.** Pilots must consider atmospheric pressure and its effect on takeoffs, landings, rate of climb, and true flight altitude. Incorrect pressure forecasts can handicap missions. This chapter begins with a general discussion of pressure, then discusses techniques to help calculate and forecast sea-level pressure, altimeter settings, pressure altitude, density altitude, and D-values.

Atmospheric pressure is the force exerted on a surface by the weight of the air above it. Station pressure is simply the atmospheric pressure measured at the station and is the base value from which sea-level pressure and altimeter settings are determined. Pressure changes most quickly in the vertical, with the most rapid changes occurring near the surface and more gradual changes with increasing height at higher altitudes. Horizontal

variations in pressure are much smaller and are caused by synoptic-scale pressure centers and diurnal pressure variations.

1. Air Mass Effects. Air masses have different thermal properties; for example, a continental polar (cP) air mass is colder and, hence, denser (higher pressure) than a maritime tropical (mT) air mass. Pressure changes due to air-mass movements are best detected by extrapolating from upstream stations, analyzing model forecast products (NGM, Eta, NOGAPS, etc.), and by looking at direct model output alphanumeric messages.

2. Diurnal Considerations. Daily heating and cooling, as well as atmospheric “tides,” cause diurnal pressure changes. On the average, two maxima occur each day, at approximately 1000L and 2200L. Likewise, there are two pressure minima, at approximately 0400L and 1600L. The difference between the maxima and minima is greatest near the equator (about 2.5 mb), decreasing to near zero above 60° latitude.

3. Standard Atmosphere. The standard atmosphere is a hypothetical vertical distribution of atmospheric temperature, pressure, and density that is taken to be representative of the atmosphere.

The international community agreed on the standard atmospheric values in order to ensure standardized pressure altimeter calibrations and aircraft performance calculations. This information (reflected in the Skew-T, Log P diagram) can be useful in comparing current or expected conditions with the standard. Table 1-35 lists pressures and temperatures associated with the standard atmosphere in 1,000-foot increments. Table 1-36 lists pressures and temperatures associated with the standard atmosphere at pressure levels.

B. PRESSURE-RELATED PARAMETERS.

1. Sea-Level Pressure (SLP). SLP is the atmospheric pressure at mean sea-level. It can be measured directly at sea level or determined from the observed station pressure at other locations. SLP is normally reported in mb and the standard is 1013.25 mb (29.92 inches of Mercury (Hg)).

a. Computing SLP. Use the following steps to obtain sea-level pressure:

Step 1. Obtain height of 1000-mb surface using the following formula (the number is negative if the 1000 mb surface is below ground level):

Table 1-35. Standard atmospheric pressure and temperatures by altitude.

U.S. Standard Atmosphere									
Altitude (ft)	Pressure		Temperature		Altitude (ft)	Pressure		Temperature	
	Millibars (mb)	Inches Of Hg	°C	°F		Millibars (mb)	Inches Of Hg	°C	°F
0	1,013.2	29.92	15.0	59.0					
1,000	977.2	28.86	13.0	55.4	26,000	359.9	10.63	-36.5	-33.7
2,000	942.1	27.82	11.0	51.9	27,000	344.3	10.17	-38.5	-37.3
3,000	908.1	26.82	9.0	48.3	28,000	329.3	9.72	-40.5	-40.9
4,000	875.1	25.84	7.1	44.7	29,000	314.8	9.30	-42.5	-44.4
5,000	843.1	24.90	5.1	41.2	30,000	300.8	8.89	-44.4	-48.0
6,000	812.0	23.98	3.1	37.6	31,000	287.4	8.49	-46.4	-51.6
7,000	781.8	23.09	1.1	34.0	32,000	274.5	8.11	-48.4	-55.1
8,000	752.6	22.22	-0.8	30.5	33,000	262.0	7.74	-50.4	-58.7
9,000	724.3	21.39	-2.8	26.9	34,000	250.0	7.38	-52.4	-52.2
10,000	696.8	20.58	-4.8	23.3	35,000	238.4	7.04	-54.3	-65.8
11,000	670.2	19.79	-6.8	19.8	36,000	227.3	6.71	-56.3	-69.4
12,000	644.4	19.03	-8.8	16.2	37,000	216.6	6.40	-56.5	-69.7
13,000	619.4	18.29	-10.8	12.6	38,000	206.5	6.10	Constant to 65,600 Feet	
14,000	595.2	17.58	-12.7	9.1	39,000	196.8	5.81		
15,000	571.8	16.89	-14.7	5.5	40,000	187.5	5.54		
16,000	549.2	16.22	-16.7	1.9	41,000	178.7	5.28		
17,000	527.2	15.57	-18.7	-1.6	42,000	170.4	5.04		
18,000	506.0	14.94	-19.7	-5.2	43,000	162.4	4.79		
19,000	485.5	14.34	-22.6	-8.8	44,000	154.7	4.57		
20,000	465.6	13.75	-24.6	-12.3	45,000	147.5	4.35		
21,000	446.4	13.18	-26.6	-15.9	46,000	140.6	4.15		
22,000	427.9	12.64	-28.6	-19.5	47,000	134.0	3.96		
23,000	410.0	12.11	-30.6	-23.9	48,000	127.7	3.77		
24,000	392.7	11.60	-32.5	-26.6	49,000	121.7	3.59		
25,000	376.0	11.10	-34.5	-30.2	50,000	116.0	3.42		

Table 1-36. Standard atmospheric pressure and temperature by level.

Pressure Level	Height Above Mean Sea-Level		Temperature
	(m)	(ft)	
(mb)	(m)	(ft)	(°C)
1000	111	364	+14.3
950	540	1773	+11.5
925	764	2520	+10
900	988	3243	+8.6
850	1457	4781	+5.5
800	1949	6394	+2.3
750	2466	8091	-1.0
700	3012	9882	-4.6
650	3591	11780	-8.3
600	4206	13801	-12.3
550	4865	15962	-16.6
500	5574	18289	-21.2
450	6344	20812	-26.2
400	7185	23574	-31.7
350	8117	26631	-37.7
300	9164	30065	-44.5
250	10363	33999	-52.3
200	11784	38662	-56.5
150	13608	44647	-56.5
100	16180	53083	-56.5

$$1000\text{-mb height} = (500\text{-mb height}) - (1000\text{-}500\text{-mb thickness})$$

Step 2. Divide 1000 mb height by 7.5 meters/mb.

Step 3. Add value of Step 2 to 1000 mb.

• **Example.** Using the upper air charts, the 500-mb height is 5500 meters, and the 1000-500-mb thickness is 5300 meters.

Step 1. 5500 meters - 5300 meters = 200 meters. The 1000-mb height is 200 meters.

Step 2. 200 meters divided by 7.5 meters/mb = 26.67 mb.

Step 3. Add 26.67 mb to 1000 mb = 1026.67 mb.

b. Modeled Output. Another way to forecast SLP is to use the NGM or Eta model alphanumeric bulletins. The third group in the bulletin is the “PSDDFF,” where PS is the sea-level pressure and the DDFF is wind direction and wind speed. The bulletin forecasts in 6-hour increments out to 48 hours. SLP is forecast in millibars, and the leading 9 or 10 are not encoded. The NGM and Eta model take diurnal effects into consideration, which makes this technique accurate and easy to use. Since this is model output, initialize and verify the model.

2. Altimeter Setting. The altimeter setting is the value of atmospheric pressure to which the scale of a pressure altimeter is set. There are three different types of altimeter settings from the Q-code system: QNE, QNH, and QFE. This code system was developed when air-to-ground communications were by wireless telegraph and many routine phrases and questions were reduced to three-letter codes. Table 1-37 explains each altimeter setting and how it affects the altimeter reading.

a. QNH. QNH is the altimeter setting Air Force Weather forecasters work with the most. Obtain the QNH altimeter setting by measuring the surface pressure and reducing it to sea-level. When QNH is set, the altimeter indicates height above mean sea-level. Follow the steps below to forecast the QNH:

Step 1. Obtain the current QNH setting in inches of Mercury (Hg) for the desired location.

Step 2. Obtain the corresponding sea-level pressure in mb.

Step 3. Forecast the sea-level pressure for the desired station.

Table 1-37. Types of altimeter settings.

Altimeter Setting	Corresponding Pressure Altimeter Reading On the Ground	Corresponding Pressure Altimeter Reading In the Air
QNE (29.92 inches of Hg or 1013.25 mb)	Airfield pressure altitude	Altitude of aircraft in a standard atmosphere.
QNH (Station pressure reduced to sea-level)	Airfield elevation above sea-level	Altitude of aircraft above sea-level without consideration of temperature.
QFE (Actual station pressure)	Zero elevation	Altitude of aircraft above ground without consideration of temperature.

Step 4. Determine the difference between current and forecast sea-level pressure.

Step 5. Multiply the sea-level difference by 0.03 (1 mb is approximately 0.03 inches Hg).

Step 6. Add or subtract (add when forecast sea-level pressure is higher than current reading) the value obtained in Step 5 to the current altimeter setting in Step 1.

• **Example:**

Step 1. Current altimeter setting is 29.98 inches.

Step 2. Current sea-level pressure is 1015.5 mb.

Step 3. Forecast sea-level pressure is 1020.5 mb.

Step 4. $1020.5 - 1015.5 = 5.0$

Step 5. $5.0 \times 0.03 = 0.15$

Step 6. $29.98 + 0.15 = 30.14$
30.14 inches of Hg is the new altimeter setting. Consider diurnal effects, upstream observations, and the synoptic situation with every pressure forecast. Subtract 0.01 from this setting for the final value to compensate for the height of the aircraft altimeter above the ground surface.

b. Pressure Conversion Product. Figure 1-56 simplifies the above method for obtaining the altimeter setting. To forecast the sea-level pressure at the desired station and desired time, enter the value and read the altimeter setting. Subtract 0.01 from this setting for the final value to compensate for the height of the altimeter above the ground.

3. Pressure Altitude (PA). PA is the altitude in the standard atmosphere at which a given pressure occurs. Or, it is the indicated altitude of a pressure altimeter with an altimeter setting of 29.92 inches of Hg. For example, if the airfield has a PA of 1,000 feet, aircraft arriving or departing perform as if the elevation is at 1,000 feet, no matter what the true field elevation is. Most aircrews require PA to calculate takeoff and landing performance data, and request this information via the Pilot-to-Metro Service (PMSV). A simple formula for calculating PA, using a given altimeter and the field elevation (FE), in feet, is:

$$PA = FE + [1000 (29.92 - QNH)]$$

In the formula, QNH is the forecast or observed altimeter setting. The QNH in the Terminal Aerodrome Forecast (TAF) is the lowest value expected during the entire forecast period. Adjust it as necessary to forecast the actual values for the time in question. Use Figure 1-56 to convert between mb and inches of Hg.

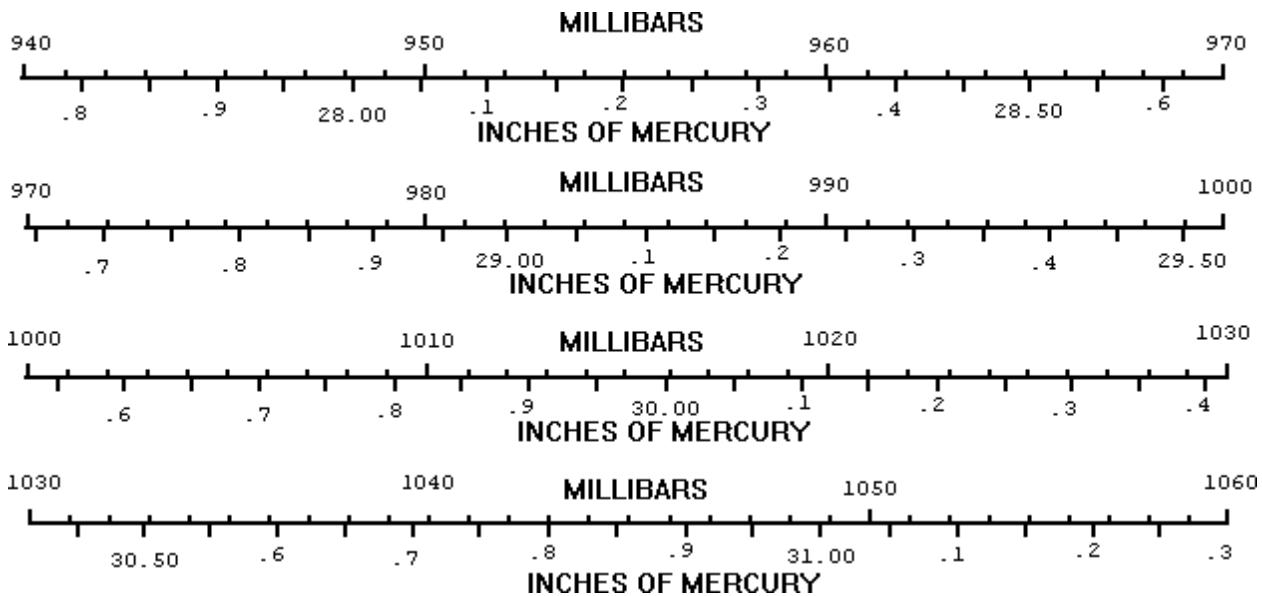

Figure 1-56. Pressure Conversion Chart. The figure gives a graphical method for obtaining the altimeter setting (see instructions in text).

• **Example 1.** Field Elevation of 590 feet and QNH of 29.72 inches of Hg.

$$\begin{aligned} PA &= FE + [1000 (29.92 - QNH)] \\ &= 590 + [1000 (29.92 - 29.72)] \\ &= 590 + [1000 (0.20)] \\ &= 590 + 200 \\ &= 790 \text{ feet} \end{aligned}$$

• **Example 2.** Field Elevation of 1,000 feet and QNH of 30.05 inches of Hg.

$$\begin{aligned} PA &= FE + [1000 (29.92 - QNH)] \\ &= 1000 + [1000 (29.92 - 30.05)] \\ &= 1000 + [1000 (-0.13)] \\ &= 1000 - 130 \\ &= 870 \text{ feet} \end{aligned}$$

4. Density Altitude (DA). DA is the pressure altitude corrected for temperature and humidity variations from the standard atmosphere. For greatest accuracy, virtual temperature—the temperature at which dry air would have the same density as a moist air sample—and not ambient air temperature should be used to calculate DA. Higher DA means less lift and thrust available to an aircraft, which affects takeoff rolls (longer), ability to climb (decreased), and payload capacity (reduced). This is especially critical for heavy airlift missions at high altitude and/or high air temperature locations.

The virtual temperature (T_v) of moist air is defined as the temperature of dry air having the same pressure and density as the moist air. T_v is always greater than actual temperature (T), unless the relative humidity is zero (which it never is, even in a desert). For zero humidity, $T = T_v$. The drier the air, the closer T_v is to T . Knowing T and obtaining the mixing ratio (w) from the Skew-T, Log P diagram, T_v can be approximated mathematically:

$$T_v = T(1 + .61w)$$

DA can be obtained by either of the computational or graphical methods described below.

a. Computed. To figure a DA (value may be five percent or more too high in high temperatures and humidities), use the following formula:

$$DA = PA + (120 \times DT)$$

The 120 in the formula represents the temperature constant and DT is the actual air temperature minus the standard atmosphere temperature at the pressure altitude. *Example:* Given a station PA of 2,010 feet, actual surface temperature of 30°C, and standard atmospheric temperature (for the given PA) of 11°C (see Table 1-36 for standard atmospheric temperatures), calculate the DA.

Step 1. 30°C - 11°C = 19°C. The temperature difference (DT) is +19°C.

Step 2. Apply the density altitude formula to calculate the DA.

$$\begin{aligned} DA &= PA + (120 \times DT) \\ &= 2010 + 120 (30 - 11) \\ &= 2010 + (120 \times 19) \\ &= 2010 + 2280 \\ &= 4290 \end{aligned}$$

The DA is +4,290 feet. This value may be five percent or more too high in high temperatures and humidities.

b. Graphical:

Step 1. Enter the base of Figure 1-57 with the virtual temperature and proceed vertically to the inclined pressure altitude line.

Step 2. From the intersection of the temperature and pressure altitude lines, proceed horizontally to the left side of the figure. Read the DA (in thousands of feet) from the scale on the left.

Example: With a virtual temperature of 22°C and a pressure altitude of 0 feet:

Step 1. From 22°C proceed vertically to the inclined PA labeled sea level (0 feet).

Step 2. From this intersection, proceed horizontally to the left edge of the product. Read the DA from the scale outside the product. The answer is 1,000 feet.

5. **D-Value.** The D-value is the difference between the true altitude of a pressure surface and the standard atmosphere altitude of this pressure surface. Methods to obtain D-value are given below:

a. Computed. To figure the D-value, use the following formula:

$$\text{D-Value} = \text{True Altitude} - \text{Standard Altitude}$$

Example: Determine the D-value for an aircraft flying at 11,000 feet MSL. Use the appropriate constant-pressure product for the flight level, in this case, the 700-mb chart. The standard height for the 700-mb level is 9,882 feet MSL (from Table 1-36). Consulting the 700-mb analysis product (or sounding), the 700-mb level is at 9,200 feet. Thus,

$$\text{D-value} = (9200 - 9882) = -682 \text{ feet}$$

b. Graphical. This method uses the graph in Figure 1-58 to compute estimates of the D-value at any altitude by interpolating between heights of standard pressure surfaces, or between surface altimeter setting and the height of a standard surface.

Step 1. Determine the altitude of interest (aircraft flight level, for example).

Step 2. Determine the observed or forecast heights (in meters) of standard pressure levels bounding the altitude of interest (a helicopter at 7,000 feet would be bound by the 700-mb and 850-mb surfaces, for example).

Step 3. If the altitude of interest is below the 850-mb level, determine the observed or forecast height of the 850-mb level (meters) and the observed or forecast surface (not reduced to sea level) altimeter setting in inches of Hg.

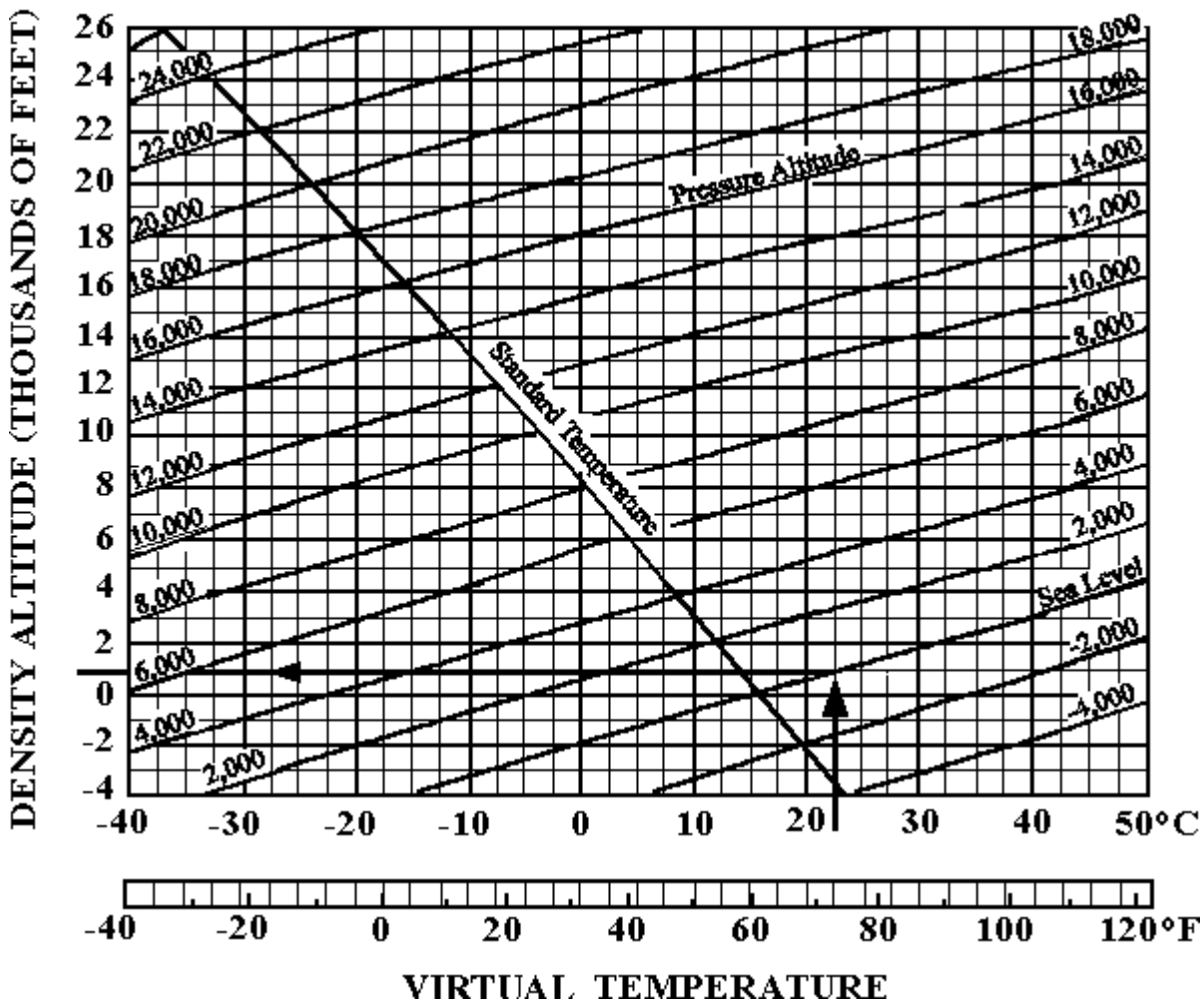

Figure 1-57. Density Altitude Computation Chart. See instructions above to graphically compute density altitude.

Step 4. Plot the heights of the pressure surfaces and/or the altimeter setting on the graph in Figure 1-58. Connect them with a straight line.

Step 5. Locate the point at which the line drawn crosses the altitude of interest, then read straight up the graph to get the D-value in feet.

Caution: The D-value change is assumed to be linear with height; the error with this assumption should not cause the estimated D-value to be off by more than 50 feet. There are other inherent errors in forecasting pressure heights and altimeter settings that could affect the estimate.

• **Example 1:** Compute a D-value for 15,000 feet, knowing the 500-mb height at the time of interest is forecast to be 5,420 meters and the 700-mb height is to be 2,940 meters. Solution: Plotting the 500-mb and 700-mb heights on the graph in Figure 1-58 and connecting them with a line, shows the line crossing the 15,000 feet altitude at a D-value of -410 meters.

• **Example 2:** Compute a D-value for 3,000 feet, given an 850-mb height of 1,640 meters and a surface altimeter of 30.15 inches of Hg. Be sure to plot the altimeter setting point on the zero altitude line, and connecting that point with the 850-mb point gives a D-value of +430 meters.

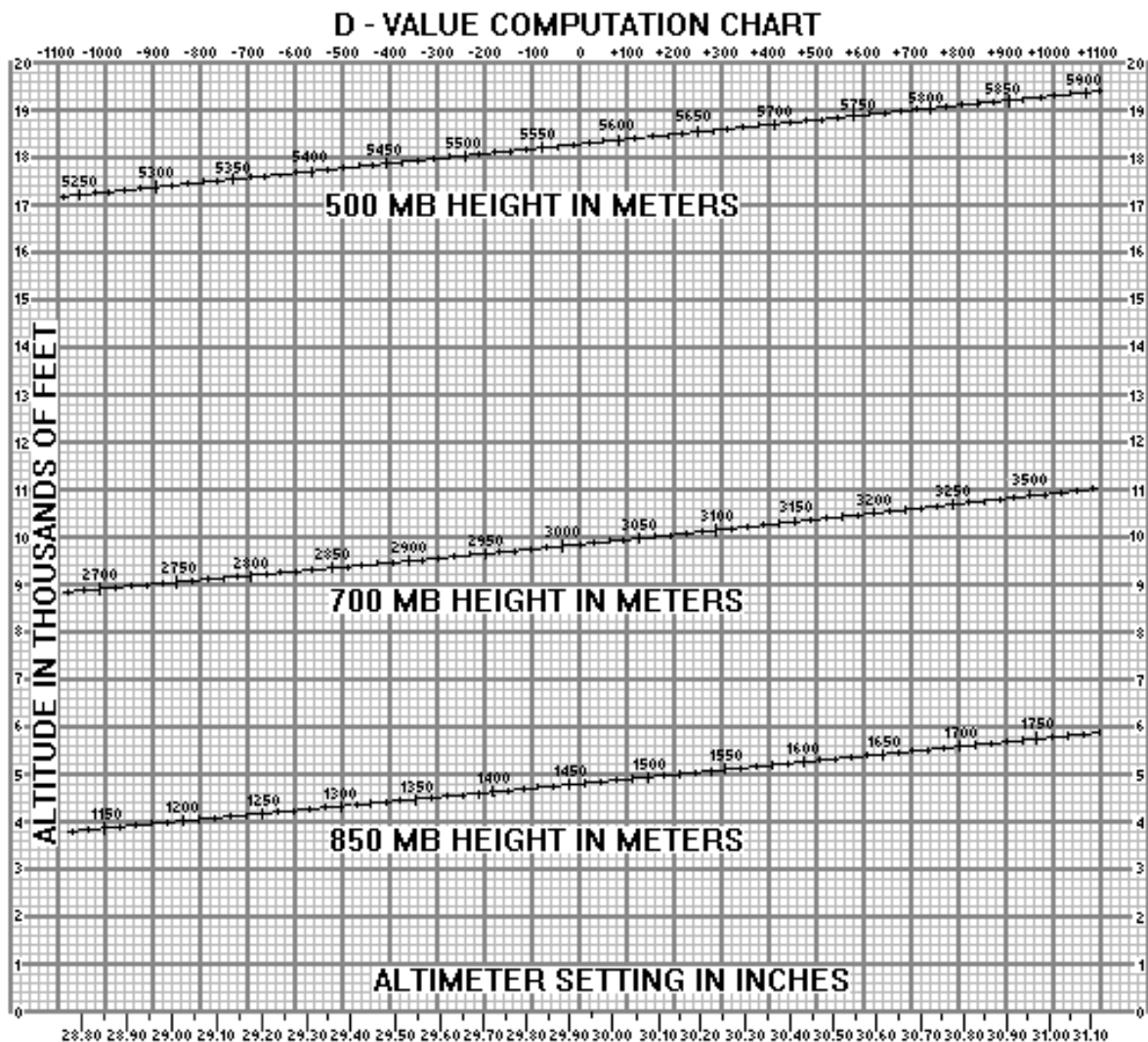

Figure 1-58. D-Value Computation Chart. The figure shows standard pressure level heights in meters and altimeter settings in inches, simplifying the computation of D-values and altimeter settings at nonstandard pressure levels.

Chapter 2

FLIGHT WEATHER ELEMENTS

I. CLOUDS. Clouds form when water vapor changes to either liquid droplets (condensation) or ice crystals (deposition). This happens when air is cooled below its saturation point either directly (radiational cooling or advection) or by being raised higher in the atmosphere (adiabatic cooling). Before beginning to forecast clouds, identification of the basic cloud types and associated characteristics are important.

A. CLOUD TYPES/STATES OF THE SKY.

Clouds are classified by how they form: “cumuliform” clouds are produced by rising air in an unstable atmosphere, while “stratiform” clouds occur when a layer of air is cooled below its saturation point without extensive vertical motion. Although stratiform clouds produce less spectacular weather, persistent low ceilings and poor visibilities, especially during the colder (and more stable) times of day or year, are critical to Air Force and Army operations.

Clouds are further classified by the altitude at which their bases form: low, middle, or high cloud layers. For example, “L1” refers to “low clouds, type 1,” as reported in the International Cloud Atlas. Keeping these basics in mind will help in understanding the various techniques and rules available for forecasting clouds. The International Cloud Atlas and the UK Meteorological Office “Cloud Types for Observers” contain some information relating cloud type with other atmospheric conditions to help forecasters.

1. Low Clouds (Near surface to 6,500 Feet Above Ground Level (AGL)).

a. Cumulus (CU). Cumulus clouds are cottony in appearance with an internal structure of updrafts and downdrafts. Cumulus clouds develop from moderate to strong lifting, especially by convection.

• L1 - Little vertical extent, may also appear flattened or ragged; good weather.

• L2 - Moderate or strong (towering) vertical development.

b. Stratocumulus (SC). Stratocumulus is formed by the spreading out of cumuliform clouds or the lifting and mixing of stratiform clouds. Precipitation from stratocumulus clouds is normally light and intermittent.

• L4 - Formed by the spreading out of cumulus.

• L5 - Not formed by the spreading out of cumulus.

• L8 - Together with cumulus; bases at different levels.

c. Stratus (ST). Stratus is sheetlike in appearance with diffuse or fibrous edges. Precipitation from stratus clouds is typically light, continuous or intermittent—but not showery.

• L6 - More or less a continuous layer or sheet, or in ragged sheets, or a combination or both, but no stratus fractus of bad weather.

• L7 - Stratus fractus or cumulus fractus of bad weather are present.

d. Cumulonimbus (CB). Massive in appearance with great vertical extent, cumulonimbus clouds are responsible for the most intense weather on earth—heavy rain, hail, lightning, tornadoes and damaging winds.

• L3 - Top lacks cirriform development; no anvil top.

• L9 - Presence of a cirriform anvil.

2. Middle Clouds (6,500 to 20,000 Feet AGL).

a. Altostratus (AS). Similar in appearance to stratus but at a higher altitude, altostratus clouds

Chapter 2

are dense enough to prevent objects from casting shadows and do not create the “halo phenomena.”

- M1 - Middle range cloud with features similar to low stratus.

b. Nimbostratus (NS). Thicker and darker than altostratus clouds, nimbostratus clouds usually produce light-to-moderate precipitation. Although classified as a middle cloud, its base usually builds downward into the low cloud height range.

- M2 - Darker gray or bluish gray; greater part dense enough to cover the sun/moon.

c. Alto cumulus (AC). The appearance is similar to SC clouds, but consist of smaller elements. Two important variations of AC are alto cumulus castellanus (ACC) and alto cumulus standing lenticular (ACSL). ACC has greater vertical extent than regular AC, implying midlevel instability. ACSL clouds are caused by the lifting action inherent in mountain waves and indicate turbulence.

- M3 - Greater part is semitransparent.

- M4 - In patches; almond or fish shaped.

- M5 - Semitransparent bands in one or more continuous layers.

- M6 - Spreading out of cumulus or cumulonimbus.

- M7 - Two or more layers; usually opaque.

- M8 - Small sproutings in the form of towers or battlements (ACC).

- M9 - Chaotic sky and occurs at several layers.

3. High Clouds (Bases above 20,000 feet AGL).

a. Cirrus (CI). Cirrus clouds consist entirely of ice crystals and have a very white appearance. A partial halo occasionally accompanies cirrus clouds; however, the presence of a complete halo usually indicates cirrostratus instead of cirrus.

- H1 - Filaments, strands, or hooks; not progressively invading the sky.

- H2 - Dense, in patches or entangled sheaves, not remains of anvil.

- H3 - Remains or the upper part of a CB (anvil).

- H4 - Hooks and/or filaments; progressively invading.

b. Cirrostratus (CS). Cirrostratus clouds appear more sheetlike than CI clouds and will produce halos if they are thin enough. CS is distinguishable from yellow-brown haze by its whiter and brighter appearance.

- H5 - Bands converging to one or two horizon points; progressively invading not further than 45° above the horizon.

- H6 - Same as H5 but extends to more than 45° above the horizon.

- H7 - Veil covering the entire celestial dome.

- H8 - No longer progressively invading and does not cover the entire celestial dome.

c. Cirrocumulus (CC). Cirrocumulus clouds appear similar to AC or ACC, but with smaller individual elements. Individual cloud elements of CC can be covered by your little finger when extended at arm's length; AC and ACC cannot. The elements can be so small that they are often difficult to see with the unaided eye. Some cirrocumulus clouds may resemble fish scales and are sometimes referred to as a “mackerel sky.”

- H9 - Individual elements, or small tufts/turrets; apparent width of less than 1°.

4. Cloud Types with a Mature Wave Cyclone.

Figure 2-1 depicts the position of cloud types that usually occur with a classic frontal wave. Overcast lower clouds may prevent higher clouds from being visible. This “limited data” type technique may help forecast layered clouds, especially when other techniques are not available.

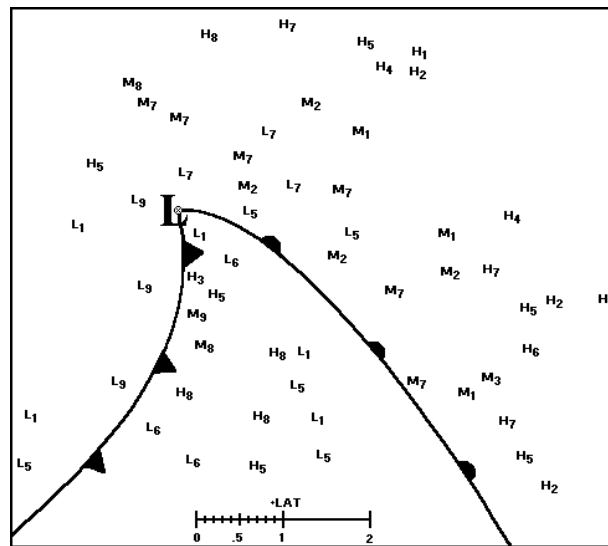

Figure 2-1. Cloud Types with Frontal Waves. The figure depicts the position of cloud types that usually occur with a classic frontal wave.

B. GENERAL FORECASTING TOOLS.

1. Climatology. Climatology is a time-proven method that works well for forecasting clouds. Derived from decades of data, some sources for climatological data are:

a. Conditional Climatology (CC). Its information is contingent upon the initial conditions. These CC tables yield valuable prognostic information on both the persistence and change characteristics of ceiling and visibility. They will display monthly and annual climatology data. Factors such as cloud cover and type of precipitation associated with the clouds are included in the calculations. There are two groupings of CC:

(1) Category-Based CC. Portrays relationships between ceiling and/or visibility and various elements (e.g., time of day, specific weather elements, wind direction, and map type.) These relationships give the most probable ceiling and visibility category when forecasting a particular element.

(2) Time-Based CC. Describes how a specific initial weather condition changes over time. The initial condition is usually a ceiling or visibility category, and in certain instances is stratified by wind direction, moisture, map type, or other

parameters. Subsequent conditions are usually portrayed as frequency distributions of ceiling and visibility categories for each hour after the initial time.

b. Modeled Ceiling/Visibility (MODCV). An electronic version of the CC tables that provides climatological forecasts for ceilings and visibility. The display can be adjusted to meet current or expected weather conditions that affect cloud forecasts.

c. International Station Meteorological Climate Summary (ISMCS). A joint US Navy (USN)/National Oceanic and Atmospheric Administration (NOAA)/USAF summary that contains almost all non-USAF station climatic summaries.

d. Station Climatic Summaries. Regional collections of individual station summaries broken down into seven major geographical areas. These summaries normally include monthly and annual climatic data for the following elements: mean and extreme temperatures (daily and monthly), relative humidity, vapor pressure, dew point, pressure altitude, surface winds, precipitation, mean cloud cover, thunderstorm and fog occurrence (mean number of days), and flying weather by ceiling and visibility categories.

Chapter 2

e. Modeled Curves (MODCURVES). A program that uses climatology as a guide to provide the temperature baseline for the time of year and time of day. Adjust the display to reflect current or expected weather conditions that may impact cloud forecasts (i.e., temperatures, winds, etc.).

f. Surface Observation Climatic Summaries (SOCS). Part D of the SOCS includes the percentage frequency of occurrence of ceiling versus visibility from hourly observations. It includes the probability of ceiling heights ranging between the surface and 20,000 feet, as well as the probability of no ceiling. A station must have 5 years of recorded observations to be included in a SOCS.

Note: These forecasting aids are available at most weather stations and can be ordered through the Air Force Combat Climatology Center (AFCCC).

2. Model and Centralized Guidance.

a. Model Output Statistics (MOS). MOS guidance is an excellent tool for cloud forecasting. MOS derives forecasting relationships by correlating past model output with station climatology. Climatology is the key ingredient. If the weather is abnormal for a particular time of year, the MOS data will be biased towards climatology (average conditions), and may not be as accurate during these times. As always, it's imperative to verify the model before using MOS. Here is a brief explanation of the MOS header formats:

- CLDS - Opaque cloud cover forecast for specified time (overcast, broken, scattered, clear).
- CIG - Ceiling height forecast for specified time (Table 2-1).

Table 2-1. Ceiling height forecast.

Ceiling Height Code	Cloud Height
1.	< 200 ft
2.	200 to 400 ft
3.	500 to 900 ft
4.	1,000 to 3,000 ft
5.	3,100 to 6,500 ft
6.	6,600 to 12,000 ft
7.	> 12,000 ft

- TSV_{xx}.- Thunderstorm/conditional severe thunderstorm probability for 6- and 12-hour periods.

- QPF - Precipitation amount forecast for 6- and 12-hour periods (Table 2-2).

- OBVIS - Obstruction to vision forecast for a specified time (H - Haze, F - Fog, and N - No haze or fog).

b. R1, R2, and R3 Values. The “R” numbers in the NGM and ETA numerical bulletins specify forecast relative humidity percents for layers of the atmosphere above a data point (station).

- R1 is the relative humidity of the surface to 1,000-foot layer centered near 500 feet AGL.

- R2 is the relative humidity of the 1,000- to 17,000-foot layer centered near 9,000 feet AGL.

- R3 is the relative humidity of the 17,000- to 39,000-foot layer centered near 28,000 feet AGL.

Use this information (after initializing and verifying the model) and Table 2-3 to help determine cloud amounts and levels through the 48-hour forecast point. Note that this technique will not necessarily help determine the cloud base, only that a cloud layer may exist in that layer. Remember also that these percentages are layer averages. Shallow cloud decks may be present that aren't identified because shallow layers of RH values become “averaged out” over the entire layer. This is especially true with the R2 and R3 layers.

c. AFWA Trajectory Forecast Bulletins. Trajectory forecasts from AFWA can help pinpoint the origin of air parcels moving towards the station.

Table 2-2. Precipitation amount forecast.

A. Value for 6-hour Period	B. Value for 12-hour Period
0. No Precipitation	0. No Precipitation
1. 0.01 to 0.09 inches	1. 0.01 to 0.09 inches
2. 0.10 to 0.24 inches	2. 0.10 to 0.24 inches
3. 0.25 to 0.49 inches	3. 0.24 to 0.49 inches
4. 0.50 to 0.99 inches	4. 0.50 to 0.99 inches
5. Greater than 0.99 inches	5. 1.00 to 1.99 inches
	6. Greater than 1.99 inches

Table 2-3. R1, R2, and R3 relative humidity values and cloud amounts.

RH %	Cloud Amount (eighths)
< 65	0
70	1 to 2
75	3 to 4
80	4 to 5
85	6 to 7
> 90	8

Knowledge of the initial position, movement, and properties of an air parcel allows for you to do an accurate advection over time. Note the observed flow at the initial point and at the end point. Interpolate between them and estimate the curvature and path of the parcel. Determine moisture advection for levels at 2,000 feet AGL, 850 mb, 700 mb, and 500 mb. Following the “n” header, the bulletin depicts the amount of cloud cover in eighths for each standard level.

There are some disadvantages to using the trajectory bulletins. The trajectories do not include changes in temperature or moisture except for adiabatic contributions; nor do they consider cooling and

moistening (by evaporation) of cool air parcels passing over warm bodies of water. Similarly, they do not consider the influences of topography.

3. Extrapolation. This technique refers to the forecasting of a weather feature based solely on its recent past movement. To use extrapolation techniques in short-range forecasting (0 to 6 hours), determine the positions of fronts and pressure systems, their direction and speed of movement, precipitation and cloud patterns that might affect the local terminal, and the upper-level flow that affects the movement of these weather patterns.

To forecast clouds by extrapolation, simply advect them downstream. For an analysis of clouds by heights or type, using a satellite or a nephanalysis will aid tremendously, especially if the previous continuity was annotated. Figure 2-2 shows an example of a nephanalysis product.

4. Weather Radar. Doppler weather radar can detect cloud layers by sensing large ice crystals present in middle- and high-level clouds and refractive index gradients associated with all clouds. Typical reflectivities are between -12 to +15 dBZ, but may range as high as +20 dbz. The following products and their uses may help in identifying and advecting clouds.

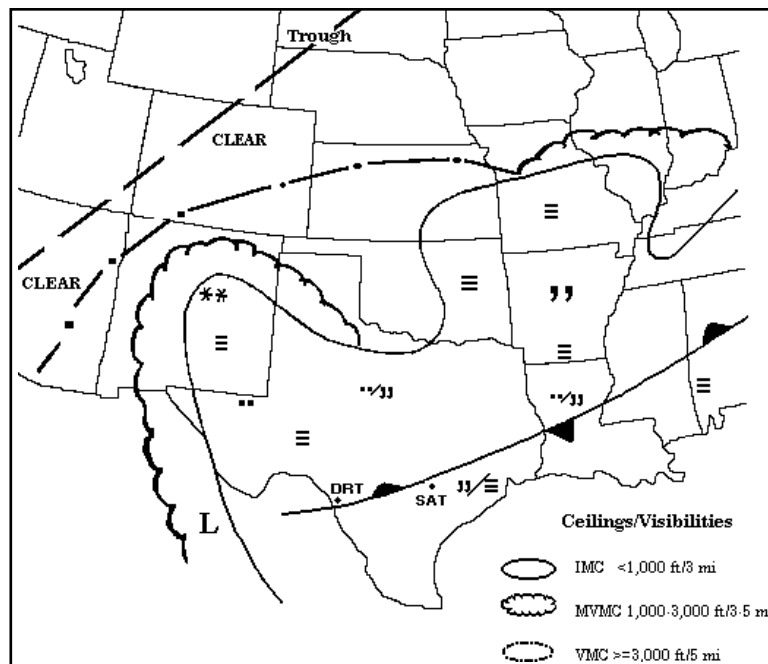

Figure 2-2. Nephanalysis Example. To forecast clouds by extrapolation, simply advect them downstream

Chapter 2

Note: Remember, most radar products are not designed to be used as stand-alone products.

a. Vertical Azimuth Display (VAD) Wind Profile (VWP). Look for “invading” upper-level wind barbs that signify clouds are progressively advancing towards the Radar Data Acquisition (RDA) unit.

b. Reflectivity (R). Determine the height, thickness, and location of clouds using this product.

Step 1. Determine and use the best elevation that depicts the cloud layer.

Step 2. Place the cursor on the edge of the echo closest to the RDA unit and note the readout of azimuth, range and elevation in mean sea level (MSL) of the base of the layer.

Step 3. Determine and use the highest elevation that shows the cloud layer.

Step 4. Place the cursor on the edge of the echo farthest from the RDA and note the readout of azimuth, range and elevation (MSL) of the top of the layer.

Note: If the cloud base or top is not uniform, repeat this technique several times to get average heights and thickness. Use a four-panel display of the reflectivity product for successively higher elevation scans. From the four-panel, determine information on the depth (top and bottom), as well as the structure of a layer, by using the steps above.

c. Reflectivity Cross Section (RCS). This product helps to infer the top of a cloud layer and its depth, depending on the distance from the radar and the viewing angle. Keep in mind, the resolution of the Base Reflectivity product is better. The RCS product integrates returns from the surface to 70,000 feet and tends to exaggerate the cloud layers.

d. Echo Tops (ET). The ET product can provide an indication of the top of a cloud layer using the threshold value of 18 dbz. Always use the reflectivity product in conjunction with ET to determine the existence and extent of the cloud layers.

C. CLOUD FORECASTING TECHNIQUES.

1. Determining Cloud Heights.

a. Using Skew-T, Log P Diagram. The mixing condensation level (MCL) is the lowest height, in a layer to be mixed by wind stirring, at which saturation occurs after the complete mixing of the layer. Use the MCL as a tool for determining the base of stratus and cold-air stratocumulus decks.

Step 1. Determine the top of the layer height to be mixed (a subjective estimate based on winds, terrain roughness, original sounding, etc.). Stations in the cold air should have a pronounced low-level (but elevated) inversion, which can be used as the top of the mixing layer.

Step 2. Determine an average temperature and dew point within that layer using an equal area method.

Step 3. Run the average temperature up the dry adiabat and the average dew point (T_d) up the mixing ratio line until they intersect. This level is the MCL, and provides a good approximation of stratus or stratocumulus base heights, if they form. Figure 2-3 illustrates this process.

The base of non-precipitating convective (cumuliform clouds) will be 25 mb above the Convective Condensation Level (CCL). The CCL is the height to which a parcel of air, if heated sufficiently from below, will rise adiabatically until it is saturated and condensation begins. In the most common case, the CCL is the height of the base of cumuliform clouds produced solely from convection.

Frequently, the surface dew point is used to compute the CCL. But when there is a great deal of variation in moisture content in the layers near the surface, an average moisture value of the lower layer may be used in place of the surface-parcel moisture value—this is known as the moist layer method. It was developed to give more accuracy in severe weather forecasting and considers the low-level moist layer of the sounding starting at the surface. Procedures for computing the CCL—parcel and moist layer—follows:

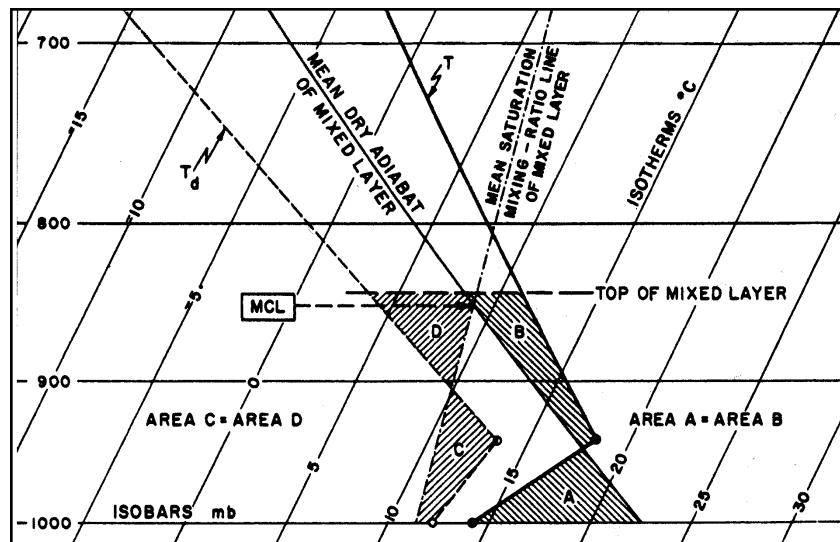

Figure 2-3. MCL Calculations. The MCL provides a good approximation of stratus or stratocumulus base heights

(1) *Parcel Method.* This is the easiest of the methods to compute. On a Skew-T, from the surface dew point, proceed up the chart parallel to the saturation mixing-ratio lines until it intersects the temperature curve on the sounding. This intersection point is the CCL, see Figure 2-4.

(2) *Moist Layer Method.* A layer is defined as “moist,” if it has an RH of 65 percent or more at all levels. In practice, the moist layer does not extend past the lowest 150 mb of the sounding. After finding the depth of the moist layer (or lowest 150

mb of the sounding – whichever is smaller), find the mean mixing ratio of this layer. Follow the mean mixing ratio line of the moist layer to the point where it crosses the temperature curve of the sounding. The level of intersection is the CCL.

b. Base of Convective Clouds Using Dew Point Depressions. Forecast the height of cumulus cloud bases by inserting current or forecast surface Dew Point Depression (DPD) into Table 2-4. This table is not suitable for use at locations situated in mountainous or hilly terrain and should be used only

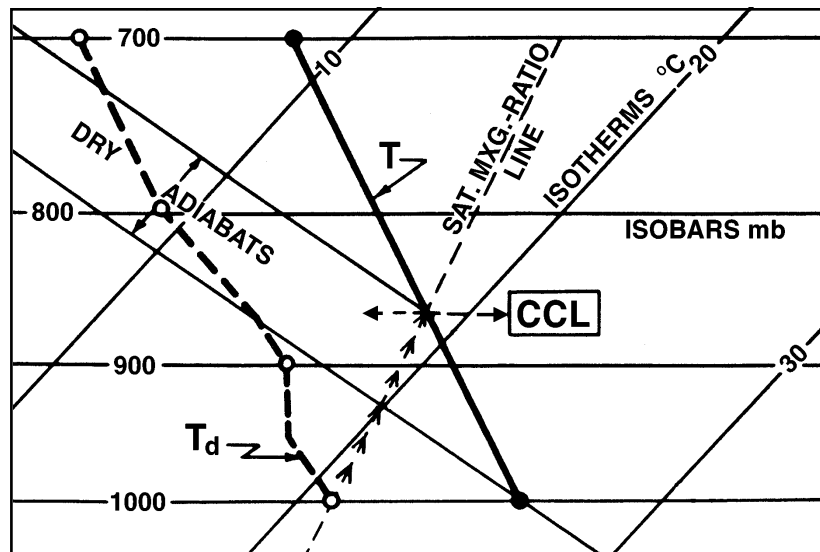

Figure 2-4. Parcel Method. To find the CCL, from the surface dew point, proceed up the chart parallel to the saturation mixing-ratio lines until it intersects the temperature curve on the sounding.

Table 2-4. Base of Convective clouds using surface dew-point depressions.

DPD (°C)	Estimated Cumulus Height (ft)	DPD (°C)	Estimated Cumulus Height (ft)
0.5	200	1.0	400
1.5	600	2.0	800
2.5	1,000	3.0	1,200
3.5	1,400	4.0	1,600
4.5	1,800	5.0	2,000
5.5	2,200	6.0	2,400
6.5	2,600	7.0	2,800
7.5	3,000	8.0	3,200
8.5	3,400	9.0	3,600
9.5	3,800	10.0	4,000
10.5	4,200	11.0	4,400
11.5	4,600	12.0	4,800
12.5	5,000		

when clouds are formed by active surface convection in the vicinity. Use with caution when the surface temperature is below freezing due to possible inaccurate dew points at low temperatures.

c. Relative Humidity and Vertical Velocity.

Upward motion is associated with instability and cloudiness. Downward vertical motion usually results in clearing skies. Figure 2-5 gives the probability of a ceiling ($n > 4$, where n is oktas of clouds) for a given Omega Vertical Velocity (OVV)

and relative humidity (RH). Obtain OVV and RH values from the ETA or NGM numerical bulletins, or from a computer analysis and display program. After initialization and verification of the model output:

Step 1. Determine the mean RH for the forecast area.

Step 2. Determine the OVV for the forecast area.

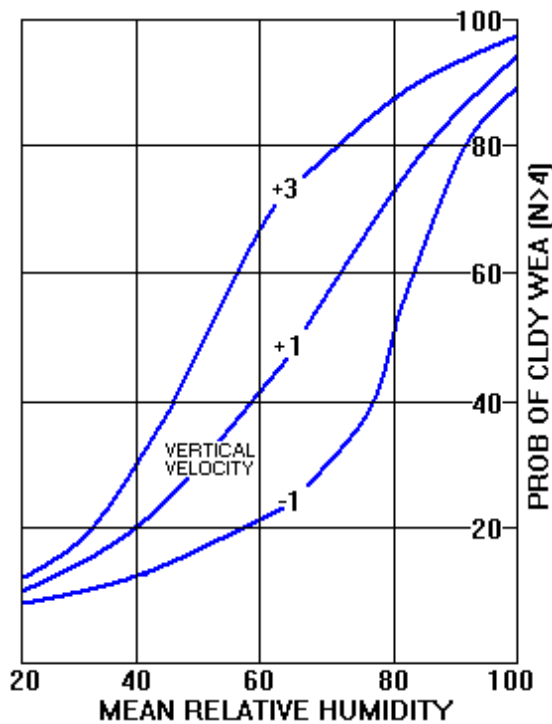

Figure 2-5. RH and OVV graph. Probability of a ceiling based on RH and OVV values.

Step 3. Using Figure 2-5, find the mean RH on the bottom axis and follow it up until it crosses the curved line whose value corresponds to the measured value for OVV.

Step 4. From that intersection, read probability of cloud ceilings using the horizontal lines.

2. Cloud Amounts.

a. Using Dew-Point Depressions. Insert the current or forecast dew-point depression into Table 2-5 to help determine the amount of clouds to forecast at any layer. This technique works well at all levels but may need adjustment for specific locations and/or time of year.

Table 2-5. Determining cloud amounts from dew-point depressions.

Dew Point Depression	Cloud Amount
0 to 2	OVC
2 to 3	BKN VRBL SCT
3 to 4	SCT
4 to 5	SCT VRBL FEW
> 5	CLR

b. Forecasting Clouds in Relation to 700 mb Features. The location and coverage of mid-level clouds can be determined by the following rules of thumb:

- Height contours and isotherms:
 - Parallel to front: extensive cloud band.
 - Perpendicular to front: narrow cloud band.
- Streamlines:
 - Cyclonic: extensive clouds.
 - Anticyclonic: few clouds.
- 700-mb ridge passage ahead of a cold front generally coincides with low and middle cloud formation.
- 700-mb trough passage after a cold front

generally coincides with low and middle cloud clearing.

3. Formation, Advection, and Dissipation of Low Stratus. Air cooled by contact with a colder surface will be transferred upwards by turbulent mixing caused by the wind. The height to which the cooling is diffused upwards depends on the stability of the atmosphere, the wind speed, and the roughness of the surface.

One study found the mean depth of the turbulent layer to be 60 meters (200 feet) for each knot of wind at ground level up to a surface wind speed of 16 knots. With stronger winds, the depth was independent of wind speed, averaging 1,066 meters (3,500 feet) in the early morning and increasing in height during the day to 1,200 meters (4,000 feet). When the atmosphere is cloud-free but initially stable in the lower layers, the layer where turbulent mixing takes place is a very shallow layer. Cooling is confined to very low levels, resulting in the formation of very low stratus or fog.

a. Wind Speed. Wind speed is usually the controlling factor in determining whether fog or stratus will form—although there is no single critical value determining which will occur. Local topography is also an important consideration. Typically, stratus will form due to nocturnal cooling with geostrophic wind speeds exceeding 15-20 knots at an inland site; 10-15 knots on an exposed coastal location, and over 30 knots in a deep valley.

b. Empirical Rules. The level at which stratus forms over land bears some relation to wind speed and the influence of local orographic features, but the dependence of cloud height on temperature and humidity prevents any simple relationship between cloud height and wind speed.

- The height of stratus in meters above level ground is 20 to 25 times the surface wind speed in knots (70 to 80 times surface wind speed in knots for height in feet).

- If advected stratus clears during the morning, the dissipation temperature will give the best estimate of the temperature at which the cloud will move inland again during the evening.

Chapter 2

c. Dissipation of Stratus Using Mixing Ratio and Temperature. Manual analysis of the morning Skew-T is often an excellent tool to use in determining the dissipation time of stratus. Use the checklist below to determine surface temperatures needed to begin dissipating and to completely dissipate stratus (see Figure 2-6).

Step 1. Find the average mixing ratio (mr) between the surface and the base of the inversion.

Step 2. Find the intersections of the average mixing ratio line and the temperature curve. The approximate height of the base is at point (A), top of the stratus deck is at point (B).

Step 3. Follow the dry adiabat from (A) to the surface. Label the surface intersection point as (C). This point is the surface temperature required to start dissipation.

Step 4. Follow the dry adiabat from (B) to the surface. Where it intersects the surface, label the point (D). Point (D) is the surface temperature required for complete dissipation.

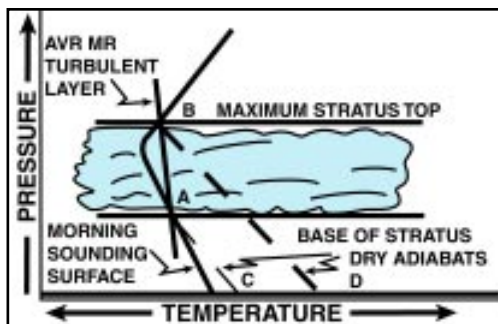

Figure 2-6. Dissipation of Stratus Using Mixing Ratio and Temperature. Use to determine temperature required to dissipate stratus.

4. Forecasting Cirrus Clouds.

a. Advective Cirrus. Cirrus clouds are of two primary types, advective and convective. Advective cirrus appears to have a relationship to the orientation, wavelength, and amplitude of the jet stream. The Gayikian method describes rules-of-thumb developed and based on the amplitude and wavelength of the jet.

Note: Figures 2-7 through 2-19 interpretation: Where two sets of contours and cirrus are displayed, solid lines indicate initial conditions and dashed lines indicate the condition towards which the situation is evolving. Light areas are cirrus associated with solid-line contours, and dark areas are associated with dashed contours. The darkest areas are where they overlap.

- Rule A1 - No change in the jet wavelength or amplitude. Forecast cirrus to exist in the same area relative to the jet that it is now near.

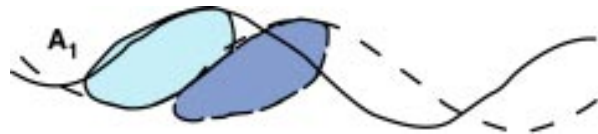

Figure 2-7. Rule A1. Cirrus generally spreads eastward.

- Rule A2 - No change in the jet wavelength, but jet amplitude increases.

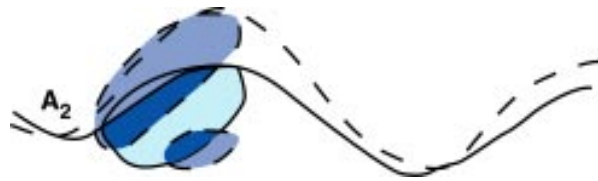

Figure 2-8. Rule A2. Cirrus spreads northward and diminishes in the south slightly. Cirrus becomes denser.

- Rule A3 - No change in the jet wavelength, but jet amplitude decreases.



Figure 2-9. Rule A3. The entire cirrus area decreases and becomes less dense.

- Rule A4 - The jet wavelength is increasing, but the amplitude remains the same.



Figure 2-10. Rule A4. Cirrus is extending further east-west and less north-south and also becomes less dense.

- Rule A8 - Wavelength of the jet is decreasing, but amplitude is increasing.



Figure 2-14. Rule A8. Cirrus area will decrease, but spread to the north, with a slight density decrease.

- Rule A5 - Both wavelength and amplitude increase.



Figure 2-11. Rule A5. Cirrus spreads northeastward with little change in density.

- Rule A9 - Both wavelength and amplitude are decreasing.



Figure 2-15. Rule A9. Cirrus area will decrease.

- Rule A6 - The jet wavelength is increasing, but the amplitude is decreasing.



Figure 2-12. Rule A6. Cirrus will tend to dissipate or coverage will decrease. Cirrus is less dense.

- Rule A7 - Wavelength of the jet is decreasing, but amplitude of the jet remains the same.



Figure 2-13. Rule A7. Cirrus will decrease in the eastern portion with no change in density.

- Rule A10 - Confluent area is developing, cirrus will form downstream near the point of inflection and build or form both up and downstream. Upstream from the maximum wind, the atmosphere is stable and cirrostratus clouds generally form. Downstream from the maximum wind, the atmosphere is unstable and cirrocumulus clouds tend to form. The greatest density will be at the point of maximum wind (Figure 2-16).

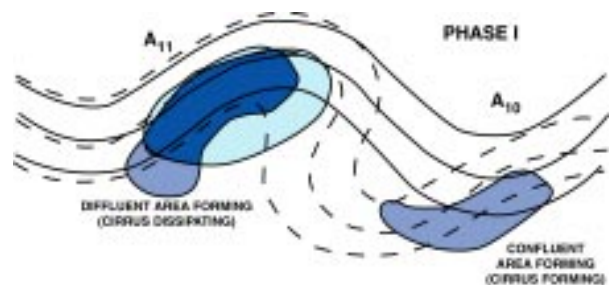

Figure 2-16. Rule A10. Cirrus will form downstream near the point of inflection and build or form both up and downstream.

Chapter 2

- Rule A11 - When a diffluent area is developing, cirrus will dissipate in the diffluent area. The area of dissipation will spread upstream (Figure 2-17).

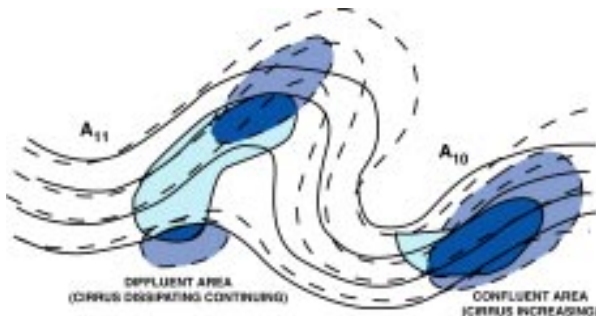

Figure 2-17. Rule A11. Cirrus dissipates in developing diffluent area, and the dissipating cirrus spreads upstream.

- Rule A12 - Cirrus rarely exists in the area south of a jet trough, but a secondary area of cirrus may be present in the low center to the north. There will be a clear area or band between this area and the area east of the trough (Figure 2-18).

- Rule A13- Cirrus usually exists in the center and back part of a ridge area to the south of the jet (Figure 2-18).

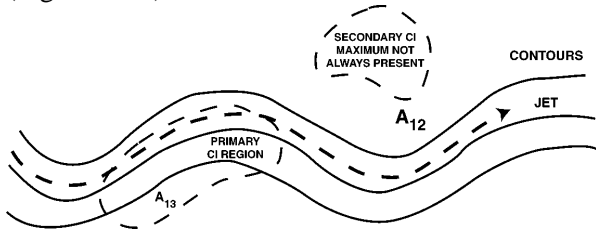

Figure 2-18. Rules A12 and A13. A secondary area of cirrus may be present in the low center to the north. Cirrus usually exists in the center of the ridge south of the jet.

- Rule A14- If the jet crosses contours towards higher heights downstream, cirrus is more likely to exist than if the jet crosses contours toward lower heights (Figure 2-19).

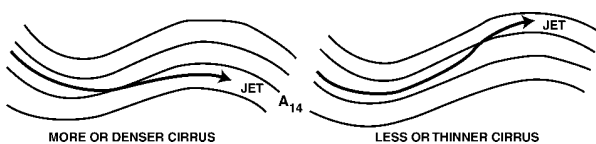

Figure 2-19. Rule A14. Cirrus is more likely to exist if the jet crosses contours toward higher heights.

- Rule A15 - Thunderstorm activity or a front within the maximum cirrus area will thicken the cirrus, lower the base, increase the height of the top, and extend cirrus to the east.

b. Convective Cirrus. For purely convective cirrus, both thunderstorm and frontal, the following rules of thumb apply:

- Rule C1 - When straight-line or anticyclonic flow exists at 300-200 mb, over the area downstream from a thunderstorm area, cirrus may appear the next day and advance ahead of the ridgeline.

- Rule C2 - Cirrus may not appear if the contours over the area downstream are cyclonically curved. It is more likely to appear, however, if the flow is weak.

c. Tropopause Method of Forecasting Cirrus. Many studies have shown the relationship between the tropopause and cirrus deck tops. In rare circumstances the cirrus deck will extend up into the lower stratosphere. A 4-year study concluded the base and tops of cirrus could be determined in relation to the tropopause. Figure 2-20 shows average cirrus bases and tops. To use this figure, find the current tropopause height and read across to see the average cirrus base and top (heights in 1000s of feet on the X and Y axes.)

5. Precipitation Induced Clouds. During continuous precipitation, cloud bases lower in a discontinuous rather than continuous manner, and the lower cloud sheet appears to form rather suddenly over extensive areas.

a. Snow. When snow falls through a layer with a temperature greater than 0°C, the snowflakes start to melt. If the dry- and wet-bulb temperatures at ground level are initially greater than 0°C, the snow ultimately reaches the ground without melting. This is due to an isothermal layer, with a temperature near 0°C, establishing itself near the ground. The air is also cooled below its wet-bulb temperature, supersaturation occurs, and stratus clouds form with bases at or very near ground level.

b. Rain. When the rain is warmer than the wet-bulb temperature, evaporation from falling rain may cause supersaturation and the formation of

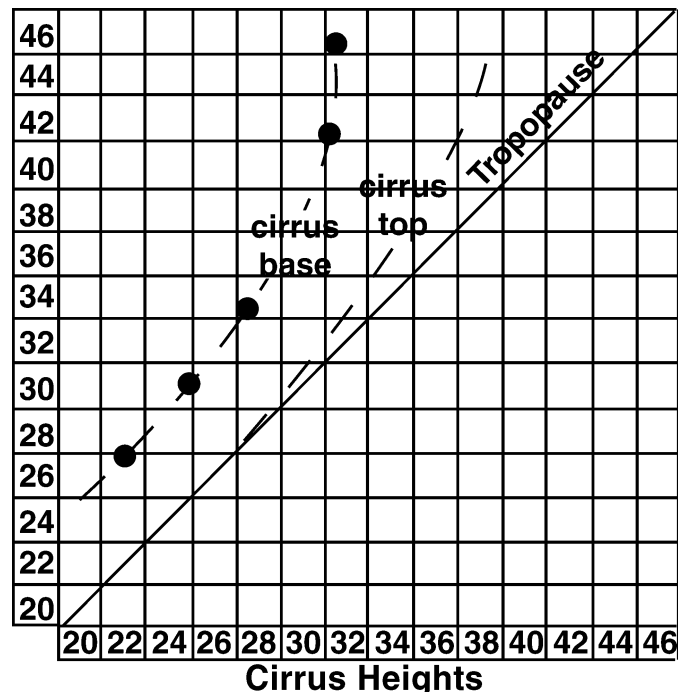

Figure 2-20. Tropopause Method of Forecasting Cirrus. Find the current tropopause height and read across to see the average cirrus base and top.

clouds. The base of the cloud layer will be at a height where the temperature lapse rate decreases or becomes negative (a positive lapse rate exists when temperature decreases with height).

6. Rules of Thumb. The following rules are empirical in nature. They may need adjustment for location and the current weather regime:

- Cloud base of a layer warmer than 0°C is usually located where the dew-point depression decreases to less than 2°C .
- Cloud base of a layer between 0° and -10°C is usually located at a level where the dew-point depression decreases to less than 3°C .
- The cloud base of a layer between -10°C and -20°C is usually located where the dew-point depression decreases to less than 4°C .
- The cloud base of a layer less than -25°C is usually located where the dew-point depression decreases to less than 6°C , but can occur with depressions as high as 15°C .

- For two adjacent layers in which the dew-point depression decreases more sharply in the lower layer than in the upper layer, the cloud base should be identified with the base of the layer showing the sharpest decrease.

- Top of the cloud layer is usually indicated by an increase in dew-point depression. Once a cloud base has been determined, the cloud is assumed to extend up to the level where a significant increase in dew-point depression starts. The gradual increase in dew-point depression that usually occurs with height is not considered significant.

- 500-mb dew-point depressions of 4°C or less coincide with overcast mid-level cloudiness.

D. REGIONAL GUIDANCE.

1. European Regional Guidance.

a. European Grid Forecasts for Clouds. The German Military Geophysical Office (GMGO) produces the FOEU bulletin for general forecasting in Europe – but it also contains excellent information for specifically forecasting clouds. Figure 2-21 (next page) is an example of the FOEU bulletin with

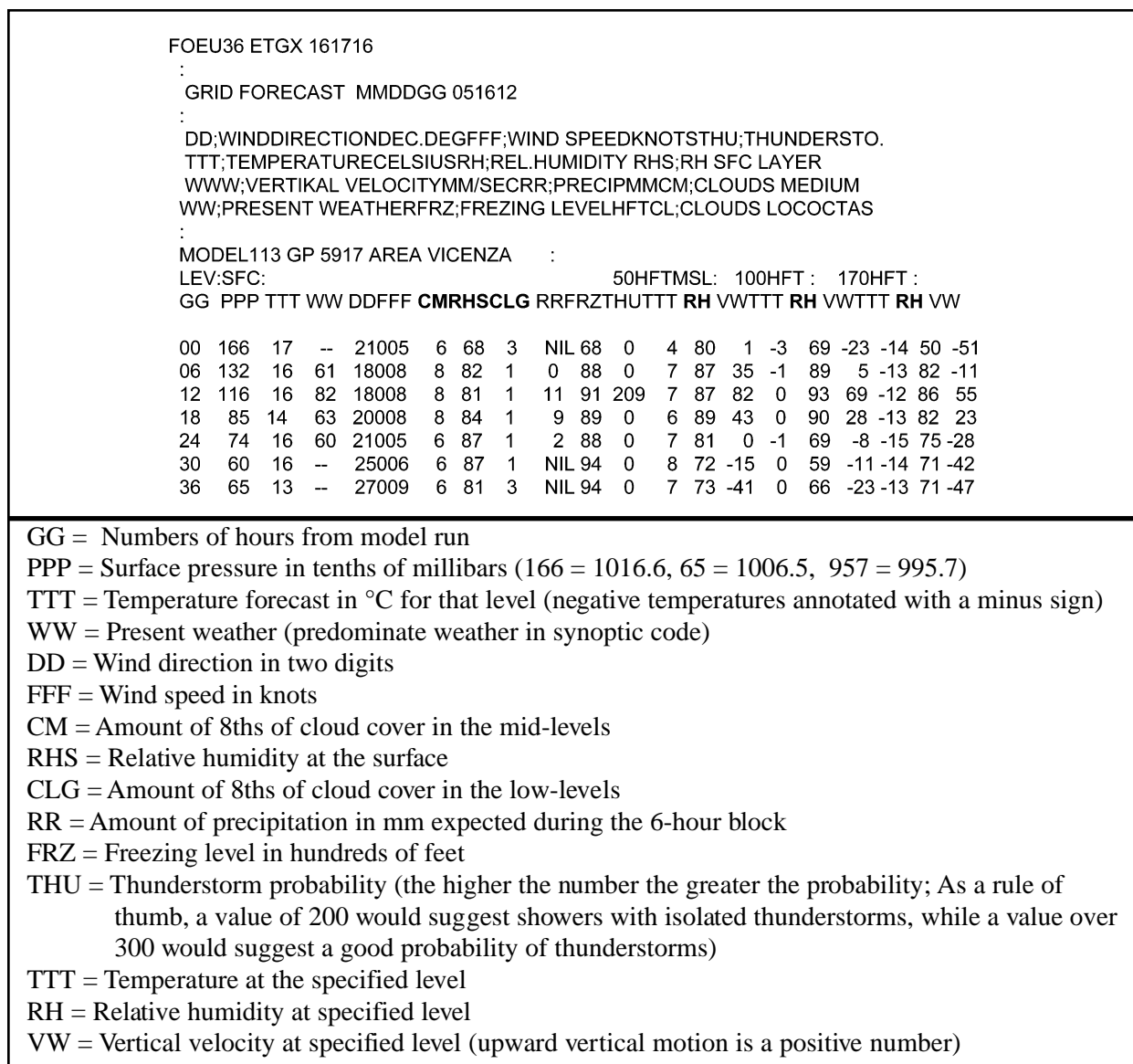

Figure 2-21. FOEU Bulletin Example. A guide to interpreting this product is provided beneath the bulletin example.

columns important to cloud forecasting highlighted in bold. Beneath the figure is breakdown that can be used as a guide to interpreting the bulletin (the bold highlighting indicates values important to cloud forecasting).

b. Figure 2-22 illustrates a typical cold air stratus/stratocumulus case after cold frontal passage. Once formed, the ceilings will remain until the high-pressure center has moved sufficiently close to the location to provide the necessary drying through subsidence to clear the skies. Indicators of this come from an increased frontal inversion height and stations clearing upstream. A slight modification

to this rule is created by the diurnal trend of the wind. Normally, turbulent mixing increases during the day because of differential heating. Consequently, cold-air stratocumulus will have a tendency to form during the day and dissipate at night.

2. CONUS Regional Guidance.

a. Stratus in the Midwest and the Low-Level Jet (LLJ). Throughout the central United States, perhaps no other four words are as important as “the gulf is open” — moisture and warm air is being advected from the Gulf of Mexico. In the fall and

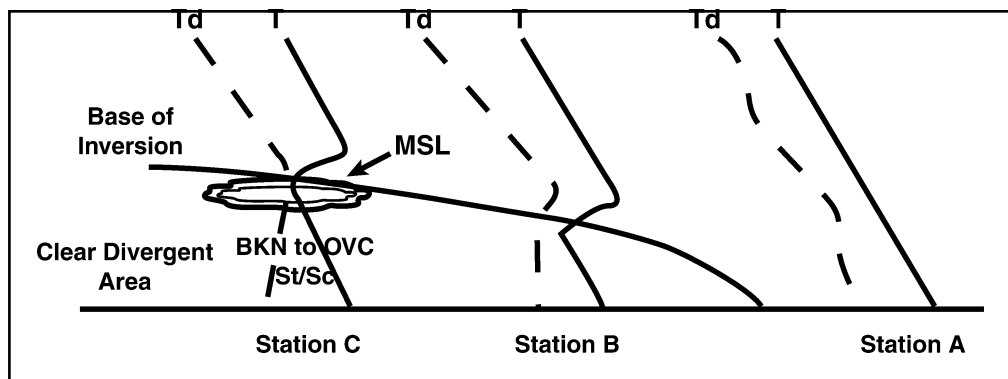

Figure 2-22. Typical Cold-Air Stratocumulus/Stratus Scenerio. Station A is still in warm air, and clouds are dependent upon the moisture and stability of the warm air mass. Station B is in the cold air, but the inversion is below the MCL, hence no stratocumulus is present. At Station C, the frontal inversion is above the calculated MCL and broken to overcast stratocumulus results. Note: ceilings formed purely from turbulent mixing generally have bases above 1,500 feet.

winter these words can mean dense fog, heavy rains, freezing precipitation, and low stratus ceilings.

In the spring and summer, the moisture and LLJ preceding or overrunning a frontal system are primary ingredients in severe thunderstorm activity. It is absolutely essential that you are able to identify the source of moisture and its rate of movement. The basic moisture source region is the western Gulf of Mexico and the basic form of transport is the LLJ. However, the LLJ does not have to be present for moisture to be advected into the region. Either way the forecaster must look to Southern Texas to properly forecast the direction and timing of the advection.

No LLJ present. A common pattern in the fall and

winter is a stationary front oriented SW-NE between the central plains and the gulf. A low center over Mexico or northern Baja California will anchor a longwave trough, with a high pressure center over the upper Midwest. Cloudiness will start out over Texas and the Gulf States, and the moisture will spread westward and northward at low levels, then infiltrate the mid-levels of the atmosphere. Eventually, as the moisture continues to flow northward, expect persistent overrunning precipitation and low stratus ceilings.

Create nephanalysis/weather depiction products to keep continuity on the leading edge of the clouds. Figure 2-2 is an example of this type of product. Satellite imagery is also useful, especially the GOES Low Cloud (LC) curve for identifying black stratus.

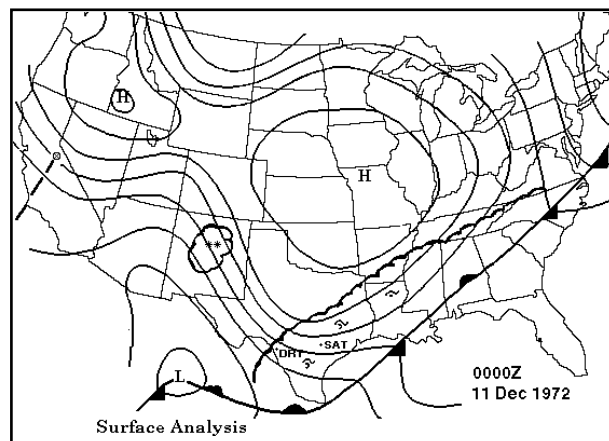

Figure 2-23. Southwest to Northeast Stationary Front. Cloud patterns stretch along the front.

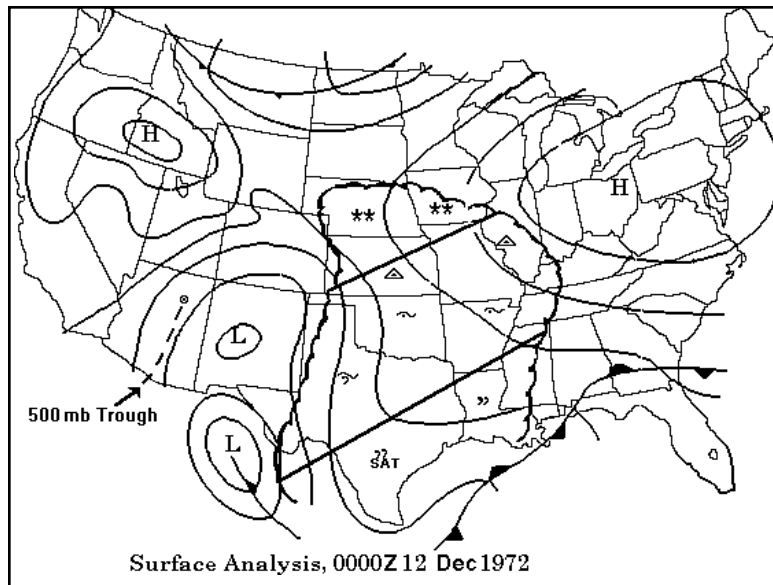

Figure 2-24. Stationary Front 24 Hours Later. Overrunning stratus and precipitation spread northward from Texas into the upper Midwest producing a variety of precipitation types

Figure 2-23 shows a similar situation with a slightly different orientation. The stationary front runs SW-NE from North Carolina across the gulf states and into Mexico with a high over northern Missouri. In 24 hours, overrunning stratus and precipitation spread northward from Texas into the upper Midwest producing a variety of precipitation types shown in Figure 2-24. Remember that continuity is a key tool in tracking these advected patterns.

The following notes apply to forecasting stratus advection:

- During the winter months, cold fronts will often move far enough south to keep the central and upper southern plains free of stratus. However, the southward extent of the frontal position is dependent upon the strength, size, and direction of movement of the surface high-pressure system and the upper wind flow.

- Watch for frontal waves and/or surface cyclogenesis. This often occurs along stationary fronts in Texas and over the Gulf of Mexico, especially when a 500-mb short wave is moving across southern New Mexico and West Texas. Track the progression of the upper trough to determine which track the frontal wave will take. Continued eastward movement of the frontal wave toward

Texas and Louisiana will prevent stratus from spreading northward and would confine precipitation to the Lower Mississippi valley and gulf coast states.

- The moisture flow from the gulf is fairly uniform. To forecast the cloud ceiling, look upstream and adjust for local conditions (upslope, elevation, and/or valley orientation). For example, a station south of your location (but also north of the front) has a 1,500-foot ceiling, its elevation is 800 feet. If your elevation is 1,000 feet, expect a ceiling at approximately 1,300 feet.

b. LLJ or Near LLJ Present. This pattern is possible all year round. Look for a deepening low-pressure system in the lee-side of the Rocky Mountains and high pressure to the east. The coupling of the surface and low-level flow ahead of the low-pressure system and on the backside of the high will create a LLJ, which advects the gulf moisture rapidly northward.

A stationary lee-side trough will maintain the low-level jet until a cold front and/or low approaching from the Rockies moves into the trough. By this time, stratus has usually advected as far north as Kansas and Missouri. The speed and magnitude of

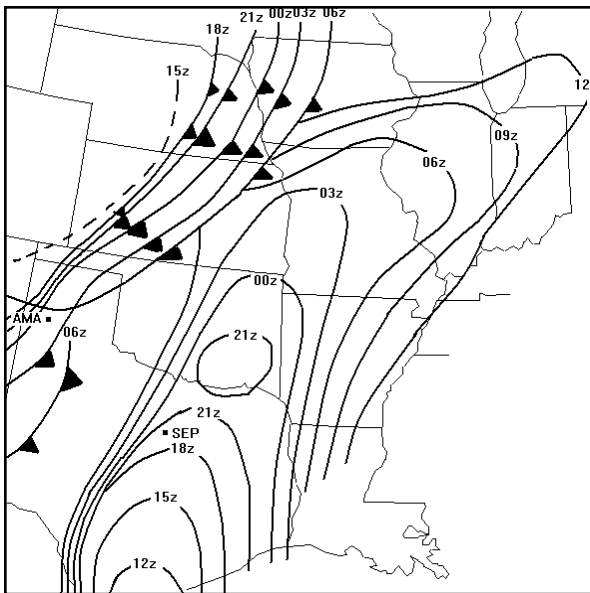

Figure 2-25. Advection of Gulf Stratus with a LLJ. A strong jet can advect significant amounts of gulf moisture from Texas to the Great Lakes within 24 hours.

the advection is dependent on the strength of the jet (see Figure 2-25).

Because a LLJ often forms in the same general area of Central Texas, a reasonable predictor of its strength is the height difference of the maximum wind layer between Stephenville, Texas (KSEP) and Amarillo, Texas (KAMA) from the 00Z sounding. The maximum wind layer is normally found between 3,000 to 4,000 feet; use the 925-mb level and Table 2-6 as a first estimate.

Table 2-6. Gradient and speed relationships.

Height Difference (m)	Approximate Jet Speed
45 to 60	30 to 40 kt
60 to 75	40 to 50 kt
75 to 90	50 to 60 kt

Note: Dial-up the WSR-88D, VWP from KSEP or KDFW — it may also be a useful tool in detecting the LLJ.

The following notes apply to forecasting moisture advection associated with the LLJ:

- Moisture advects at approximately the average speed of the LLJ.

- LLJ maximum wind speeds over central Texas occasionally reach the 80- to 90-knot range in the early morning hours (0600Z), especially in the spring. This diurnal effect rarely lasts over 4 hours. Do not use diurnal speed as average advection rate.

- Even though the actual moisture advection is fairly constant, the presence of clouds may not be. Clouds often dissipate during the day and reform at night. Clouds may dissipate due to localized downslope flow and reform over areas where the flow again turns upward (see Figure 2-26).

c. CONUS Main Moisture Stratus Tracks.

The track of the advection is controlled by the orientation of the jet, which is controlled by the orientation of the retreating high-pressure system. There are three main moisture/stratus tracks. In each case the main moisture axis (stratus ceilings) are located to the right and parallel to the LLJ axis.

- (1) *Type 1.* The Bermuda High axis has shifted westward. Moist air moves into the coastal areas of Eastern Mexico and advects to the Northwest, east of the Sierra Madre Oriental mountains. Del Rio (KDRT) and Laredo (KLRD)

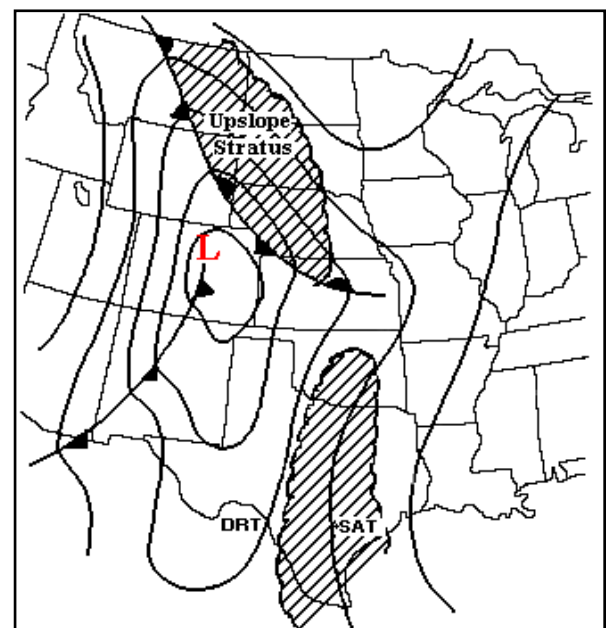

Figure 2-26. Typical Gulf Stratus Coverage. Surface and low-level flow ahead of the low-pressure system and on the back-side of the high will create a LLJ, which advects the gulf moisture northward.

Chapter 2

are often the first stations in Texas to be affected. The moisture advects rapidly northward into western Texas, Oklahoma, and Kansas. The moisture continues to track into central Kansas and curves northeasterly into Nebraska. Upslope stratus along the secondary track tends to dissipate with surface heating; however, dissipation along the main track will be much slower. See Figure 2-27.

(2) *Type 2.* Look for an extensive surface high over the Northeastern US. Strong southeasterly flow sets up at low levels through the Gulf. The first evidence of the increased moisture advection can occur anywhere along the Texas coast. Stratus forms at about 2,500 feet with tops at about 5,000 feet. This type of stratus will advect reliably into the central plains and normally resists dissipation until the air mass changes. See Figure 2-28.

(3) *Type 3.* This track occurs when strong, moist, low-level flow occurs with dry southwest flow above. The LLJ forms lower and further south than normal. Look for a pocket of stratus to form near San Antonio, Texas (KSAT) and spread rapidly northward. Formation usually begins at night. Look for stratus ceilings to form below 1,500 feet.

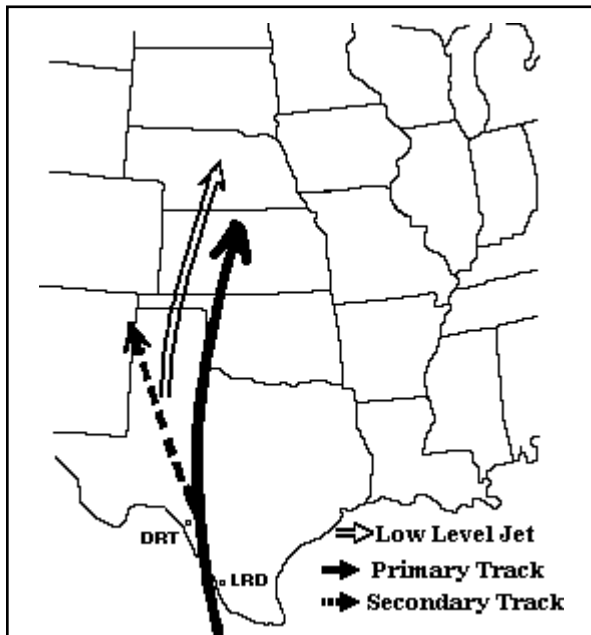

Figure 2-27. Type 1 Gulf Stratus Advection. Moist air enters coastal Mexico and tracks north-west, then north into Nebraska.

Stratus usually advects rapidly ahead of cold fronts located in central Oklahoma, Kansas, and Nebraska. A secondary track sets up when strong lows develop along maritime polar (mP) frontal systems moving from the Rockies. Intense jets result in rapid moisture advection into the low systems. In early fall and late spring, north-south cold fronts from the Rockies can become quasi-stationary through western or central Kansas and Nebraska. These fronts will persist for days before passage of an upper trough moves them out. Look for late evening/early morning stratus formation ahead of these fronts. By midafternoon the stratus becomes broken or scattered CU/SC, and by late afternoon, differential heating contributes to thunderstorm formation along the front. See Figure 2-29.

The following notes apply to forecasting moisture advection associated with the main moisture tracks:

- In the past, the 850-mb analysis was the primary guide to low-level moisture advection. However, the 925-mb level is a much more accurate tool for investigating the lowest 3,000 feet of the atmosphere. The 850-mb level is not recommended, particularly when advected ceilings are below 2,000 feet. The LLJ's maximum winds and moisture

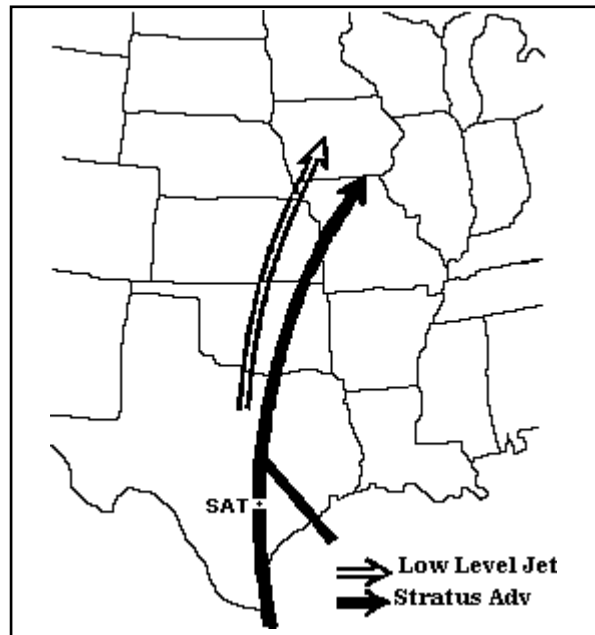

Figure 2-28. Type 2 Gulf Stratus Advection. This type of stratus advects into the central plains and remains until the air mass changes.

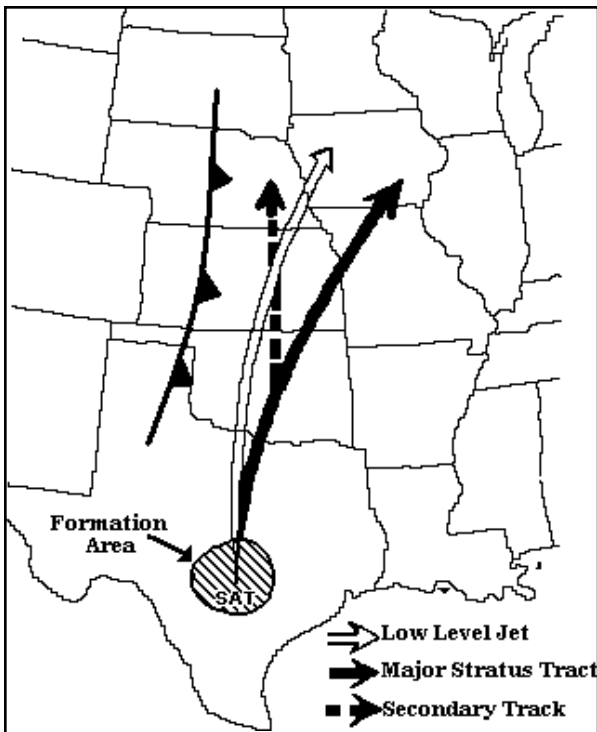

Figure 2-29. Type 3 Gulf Stratus Advection. This type of stratus forms over San Antonio, Texas and moves rapidly northward.

advection are often below the 850-mb level. For a Type 3 LLJ, advection often occurs below 5,000 feet and the 850-mb product will usually reflect dry air throughout most of the southern plains.

- Only after advection has persisted and stratus tops have increased will they reach into the 850-mb level and above. In many cases during northward advection, and especially at night, the 850-mb pressure and wind patterns will show a southwest-northeast flow over the advection track. The 925-mb or gradient-level wind flow charts are much better tools to use in forecasting the direction of the advection when downstream stations already affected are reporting ceilings below 2,500 feet. Locations along the western edge of advection should pay particular attention to the surface to 2,000-foot wind directions under southerly flow. The layer of air near the surface cools at night and the southerly wind tends to back toward the southeast.

- Stratus advects northwestward toward higher elevations, causing upslope flow. Thus, lower ceilings may appear to suddenly occur west of the main area of stratus. In Figure 2-30, the main advection track appears at the 850 mb level from Eastern Texas to Illinois and follows the wind flow. Lowering stratus ceilings below 1,500 feet over Southeast Kansas continued northward and westward during the 00Z and 12Z period and by 12Z, encompassed large portions of Nebraska and Iowa.

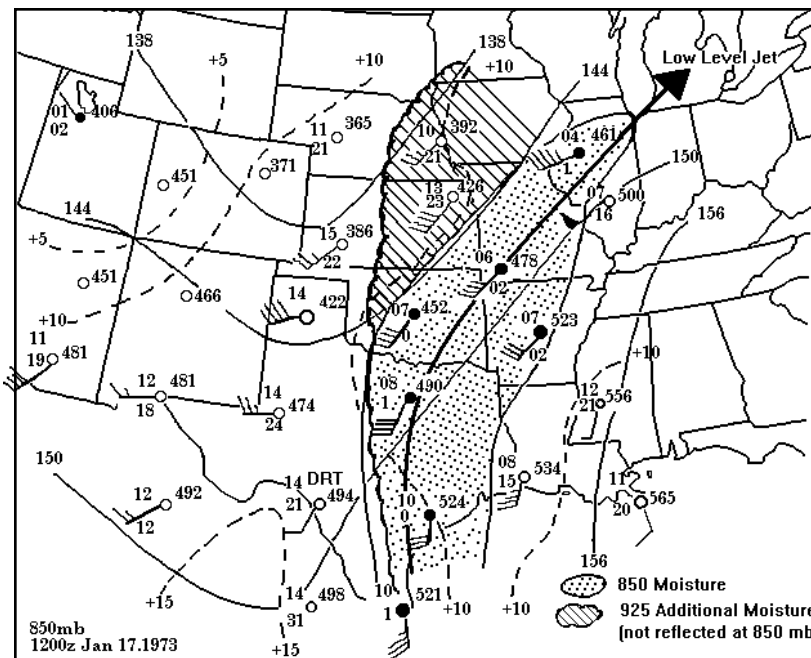

Figure 2-30. Gulf Stratus Advection Track. The figure depicts the extent of Gulf stratus advection at the 850-mb and 925-mb levels.

Chapter 2

II. TURBULENCE. The importance of turbulence forecasting to the flying customer can't be overstated. Forecasting and classifying turbulence, however, is a challenge. The difficulty arises because factors creating turbulence in one instance may not cause turbulence in a similar situation. Complicating matters further is that while one aircraft may report smooth sailing, minutes later, another aircraft flying through the same airspace may report significant turbulence.

Turbulence can rip an aircraft apart in flight, damage the airframe, and cause injury. Therefore, accurate turbulence forecasts are an important part of an aviation brief. If forecasters understand the basics of atmospheric turbulence, they will better analyze and forecast this dangerous phenomenon.

Note: Diagrams presented may show patterns over the United States only. These patterns are applicable, however, to most areas worldwide, given the same synoptic situation.

A. LEVELS OF INTENSITY. The levels of turbulence intensity are based on the impact to aircraft flying through the area of concern.

1. Light Turbulence. The aircraft experiences slight, erratic changes in attitude and/or altitude, caused by a slight variation in airspeed of 5 to 14 knots with a vertical gust velocity of 5 to 19 feet per second. Light turbulence may be found in many areas, such as:

- At low altitudes in rough terrain when winds exceed 15 knots.
- In mountainous areas, even with light winds.
- In and near cumulus clouds.
- Near the tropopause.

2. Moderate Turbulence. The aircraft experiences moderate changes in attitude and/or altitude, but the pilot remains in positive control at all times. The aircraft encounters small variations in airspeed of 15 to 24 knots; vertical gust velocity is 20 to 35 feet per second. Moderate turbulence may be found:

- In towering cumuliform clouds and thunderstorms.
- Within 100 nm of the jet stream on the cold-air side.
- At low altitudes in rough terrain when the surface winds exceed 25 knots.
- In mountain waves (up to 300 miles leeward of ridge), winds perpendicular to the ridge exceed 50 knots.
- In mountain waves as far as 150 miles leeward of the ridge and 5,000 feet above the tropopause when wind perpendicular to the ridge is 25 to 50 knots.

3. Severe Turbulence. The aircraft experiences abrupt changes in attitude and/or altitude and may be out of the pilot's control for short periods. The aircraft encounters large variations in airspeed greater than or equal to 25 knots and the vertical gust velocity is 36 to 49 feet per second. Severe turbulence occurs:

- In and near mature thunderstorms.
- Near jet stream altitude and about 50 to 100 miles on the cold-air side of the jet core.
- In mountain waves (up to 50 miles leeward of ridge), winds perpendicular to ridge are 25 to 50 knots.
- Up to 150 nm leeward of the ridge and within 5,000 feet of the tropopause when a mountain wave exists and winds perpendicular to the ridge exceed 50 knots.

4. Extreme Turbulence. The aircraft is violently tossed about and is practically impossible to control. Structural damage may occur. Rapid fluctuations in airspeed are the same as severe turbulence (greater than or equal to 25 knots) and the vertical gust velocity is greater than or equal to 50 feet per second. Though extreme turbulence is rarely encountered, it is usually found in the strongest forms of convection and wind shear. The two most frequent locations of extreme turbulence are:

- In mountain waves in or near the rotor cloud.
- In severe thunderstorms, especially in organized squall lines.

B. AIRCRAFT TURBULENCE SENSITIVITIES. Different aircraft types have different sensitivities to turbulence. Table 2-7 lists the categories for most military fixed-wing and rotary-wing aircraft at their typical flight configurations. Turbulence forecasts in Aerodrome Forecasts (TAFs) are specified for Category II aircraft. Modify the local turbulence forecast for the type of aircraft supported. Use caution, however; an aircraft’s sensitivity varies considerably with its weight (amount of fuel, cargo, munitions, etc.), air density, wing surface area, wing sweep angle, airspeed, and aircraft flight “attitude.” Since aircraft sensitivity to turbulence varies considerably, use caution when applying forecast turbulence (Category II) to a specific aircraft type, configuration, and mission profile. Table 2-8 is a guide to convert turbulence intensities for the different categories of aircraft.

Table 2-7. Aircraft category type.

Category	Aircraft Type			
I	OH-58	UH-1	AH-1	
II	C-141	C-9	RAH-66	C-12
	C-21	F-106	C-20	C-5A
	E-4A	F-15	AH-64	B-52
	C-130	C-17	F-117	F-16
	KC-135	C-23	CH-47	U-21
	OV-1	CH-3	UH-60	CH-53
III	CH-54	VC-137	T-38	
	OV-10	KC-10	T-37	A-10
IV	A-7	F-4	B-1B	F-111*

* At 50 degree wing configuration.

Note: turbulence thresholds were developed for aircraft in Category II. Consider the synoptic situation, local terrain effects, pilot reports (PIREPS), and aircraft type and configuration before making turbulence forecasts.

Table 2-8. Turbulence intensities for different categories of aircraft (based on Table 2-7).

	I	II	III	IV
	N	N	N	N
	(L)	N	N	N
	L	(L)	N	N
	L-(M)	L	(L)	N
Turbulence	M	L-(M)	L	(L)
Reported As	M-(S)	M	L-(M)	L
	S	M-(S)	M	L-(M)
	S-(X)	S	M-(S)	M
	X	S-(X)	S	M-(S)
	X	X	S-(X)	S
	X	X	X	S-(X)
	X	X	X	X

N = None () = Occasional (less than 1/3 of the time)
 L = Light M = Moderate S = Severe X = Extreme

Note: Use caution when converting extreme turbulence reports between various aircraft types. Extreme turbulence causes a range of effects from a minimum threshold (rapid airspeed fluctuations greater than 25 knots) to a maximum threshold (structural damage). Even though the table considers this, the design is more for the sake of “completeness” rather than observational or scientific evidence.

Chapter 2

1. Fixed Wing Aircraft. Generally, the effects of turbulence for fixed-wing aircraft are increased with:

- Non-level flight.
- Increased airspeed.
- Increased wing surface area.
- Decreased weight of the aircraft.
- Decreased air density (increased altitude).
- Decreased wing sweep angle (wings more perpendicular to fuselage).

2. Rotary Wing Aircraft. Generally, the effects of turbulence for rotary-wing aircraft are increased with:

- Increased airspeed.
- Decreased weight of the aircraft.
- Decreased lift velocity (the faster the lift-off, the less the turbulence).
- Increased arc of the rotor blade (the longer the blade, the greater the turbulence).

C. CAUSES OF TURBULENCE. Turbulence is caused by abrupt, irregular movements of air that create sharp, quick updrafts/downdrafts. These updrafts and downdrafts occur in combinations and move aircraft unexpectedly. There are two basic atmospheric conditions that cause turbulence to occur: thermal conditions and mechanical mixing.

1. Thermal Conditions. Surface heating can generate turbulent conditions. As solar radiation heats the surface, the air above it is warmed by contact. Warmer air is less dense, and “bubbles” of warm air rise upward as updrafts. Uneven surface heating, and the cooling of risen air, allows for areas of downdrafts as well. These vertical motions may be restricted to low levels, or may generate cumulus clouds that can grow to great heights as thunderstorms. The following are characteristics of thermal-induced turbulence.

- The maximum occurrence is between late morning and late afternoon.
- Is normally confined to the lower troposphere (surface to 10,000 feet).
- The impact on flight operations is greatest during terminal approach and departure and during low-level flights.
- Moderate turbulence may occur in hot, arid regions, as the result of irregular convective currents from intense surface heating.

The strongest thermal turbulence is found in and around thunderstorms. Moderate or severe turbulence can be found anywhere within the storm, including the clear air along its outer edges. The highest probability of turbulence is found in the storm core, between 10,000 and 15,000 feet.

2. Mechanical Turbulence. Mechanical turbulence is caused by horizontal and vertical wind shear and is the result of pressure gradient differences, terrain obstructions, or frontal zone shear. Three types of mechanical turbulence discussed later in this chapter include the following: Clear Air Turbulence (CAT), Mountain Wave (MV) Turbulence, and Wake Turbulence. The following are some general characteristics of mechanical turbulence:

- Most turbulence results from a combination of horizontal and vertical wind shears.
- Turbulence layers are usually 2,000 feet thick, 10 to 40 miles wide, and several times longer than wide.
- Wind shear turbulence results from strong horizontal pressure gradients alone. It occurs when the pressure gradient causes a horizontal shear in either wind direction or speed.
- Local terrain can magnify gradient winds to cause strong winds and turbulence near the surface. This creates eddy currents that can make low-level flight operations hazardous.

- Most turbulence resulting from upper frontal zone shear occurs between 10,000 and 30,000 feet.

- The jet stream causes most turbulence in the upper troposphere and lower stratosphere, usually occurring in patches and layers, with the stronger turbulence on the low-pressure (cold-air side) of the jet stream.

- Strong turbulence is often associated with irregular and mountainous terrain. The greater the irregularity of the terrain and the sharper the slope of mountains, the greater the intensity and vertical extent of the turbulence.

- Fronts may produce moderate or greater turbulence.

- Turbulence intensity depends on the strength and speed of the front.

- Over rough terrain, fronts produce moderate or greater low-level turbulence.

- Updrafts may reach 1,000 feet per minute in a narrow zone at low levels just ahead of the front.

- Over flat terrain, fronts moving over 30

knots produce moderate or greater low-level turbulence.

D. CLEAR AIR TURBULENCE (CAT). CAT includes turbulence not associated with visible convective activity. It includes high-level frontal and jet stream turbulence. It may also occur in high-level, non-convective clouds. The following paragraphs describe the classic locations of CAT under specific meteorological conditions. CAT is not limited to these locations; adjustments to the forecast position may be necessary.

1. Surface and Upper-Level Low Patterns.

a. Surface Cyclogenesis. When cyclogenesis occurs, forecast CAT near the jet stream core N-NE of the surface low development (Figure 2-31a). Sometimes the surface low redevelops north of the main jet, with a formation of a secondary jet (Figure 2-31b). Numerical models may not forecast this jet genesis. CAT intensity is directly related to the strength of cyclogenesis, to the proximity of mountains, to the intensity of the jet core, and to the amplification and curvature of the downstream ridge. For cyclogenesis less than 1 mb/hour, expect moderate CAT and for cyclogenesis greater than or equal to 1 mb/hour, expect moderate-to-severe CAT.

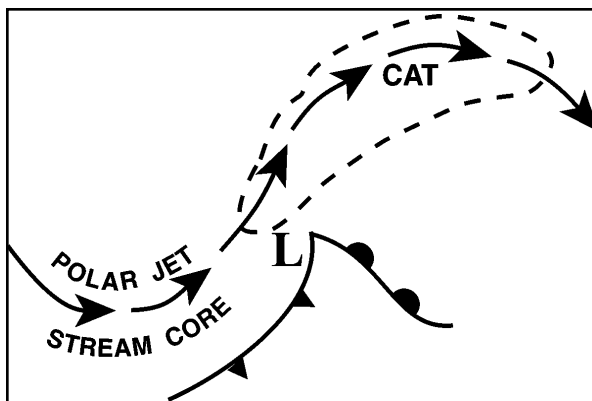

Figure 2-31a. CAT and Surface Cyclogenesis. The figure shows CAT near the jet stream core north to northeast of the surface low development.

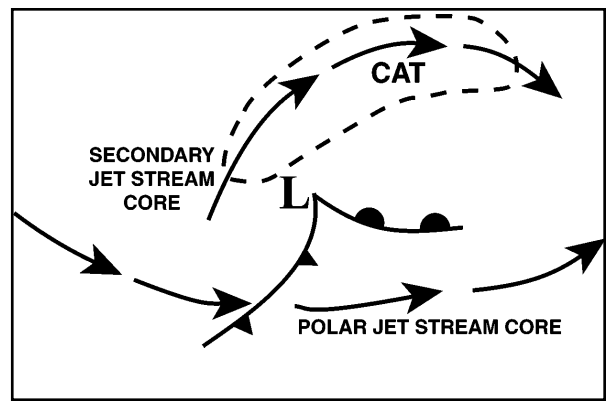

Figure 2-31b. CAT and Surface Cyclogenesis North of the Main Jet. The figure shows CAT near a secondary jet stream core north to northeast of the surface low that developed north of the main jet.

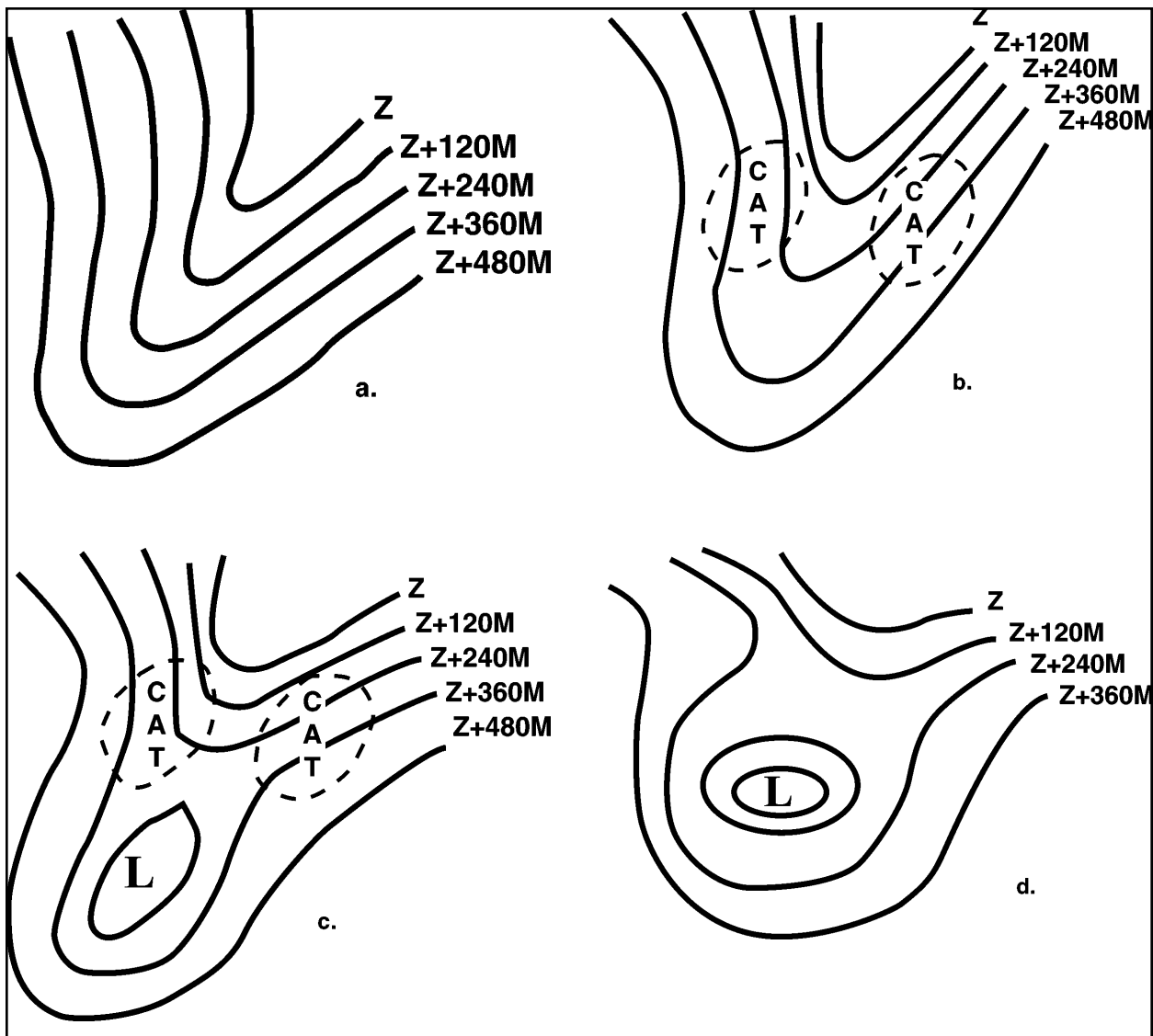

Figure 2-32a-d. CAT and Upper-Level Lows. Figure shows CAT development in various stages during development of a cut-off low.

b. Upper-Level Lows. There is a potential for moderate CAT in the development of cutoff, upper-level lows. The sequence in Figure 2-32a-d shows CAT development in various stages during development of a cutoff low. CAT usually forms in the areas of confluent and diffluent flow. Once the low is cutoff, CAT will diminish to light in the vicinity of the low.

c. 500-mb CAT Criteria. The 500-mb product is useful for forecasting CAT. However, do not use it exclusively. Consider data at all available levels. The following patterns may signal CAT:

- Shortwave troughs near one another (double troughs).

- Well-defined thermal trough.
- A narrow band of strong winds with strong horizontal wind shears.
- Closed isotherm cold pocket moving through an open flow pattern (i.e., height field with no closed contours).
- 500-mb winds greater than 75 knots in areas with wind shifts greater than or equal to 20°, and tight thermal gradients.
- Troughs associated with a surface frontal wave (often indicated by sharply curved isotherms around the northern edge of a warm tongue).

Note: Unless otherwise indicated, Figures 2-32 through 2-46 show 500-mb level data, though text will also associate turbulence observed at other levels.

d. Shear Lines in Upper-Level Lows. Forecast moderate CAT when the jet stream is greater than or equal to 50 knots around a closed upper-level low, and a very narrow neck occurs with a shear line separating the prevailing flow around the low. Forecast moderate to severe CAT if the jet reaches 115 knots. The potential for CAT is greatest between the two anticyclonically curved portions of the jet (see Figure 2-33).

2. Wind.

a. Jet Stream Turbulence Model. In the early 1960s, the meteorology department at United Airlines developed a basic jet stream turbulence model (Figure 2-34). The following applies to CAT occurrence in the model:

- Associated with converging polar and subtropical jets, mountain waves, and strong upper-level frontal zones.

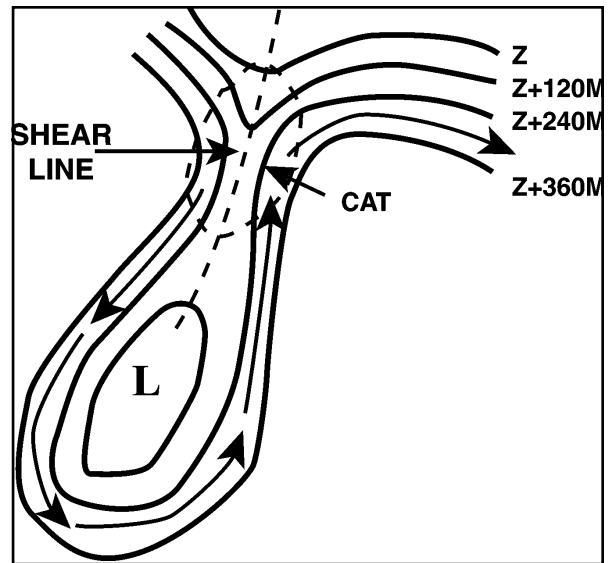

Figure 2-33. CAT and the Shear Line in the Throat of an Upper-Level Low. Forecast moderate or greater turbulence when a shear line separates the prevailing winds around a low.

- Horizontal wind shear should be greater than 40 knots/150 nm and/or vertical wind shear should be greater than 6 knots/1,000 feet.

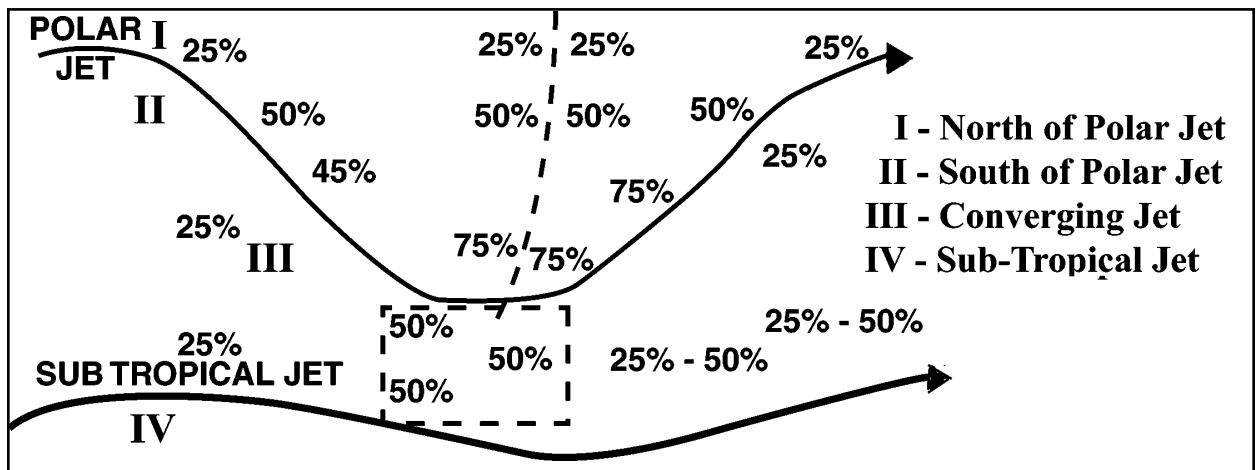

Figure 2-34. United Airlines Jet Stream Turbulence Model. A flight through the box would have a 50 percent chance of encountering CAT. Probabilities are not cumulative and are estimated.

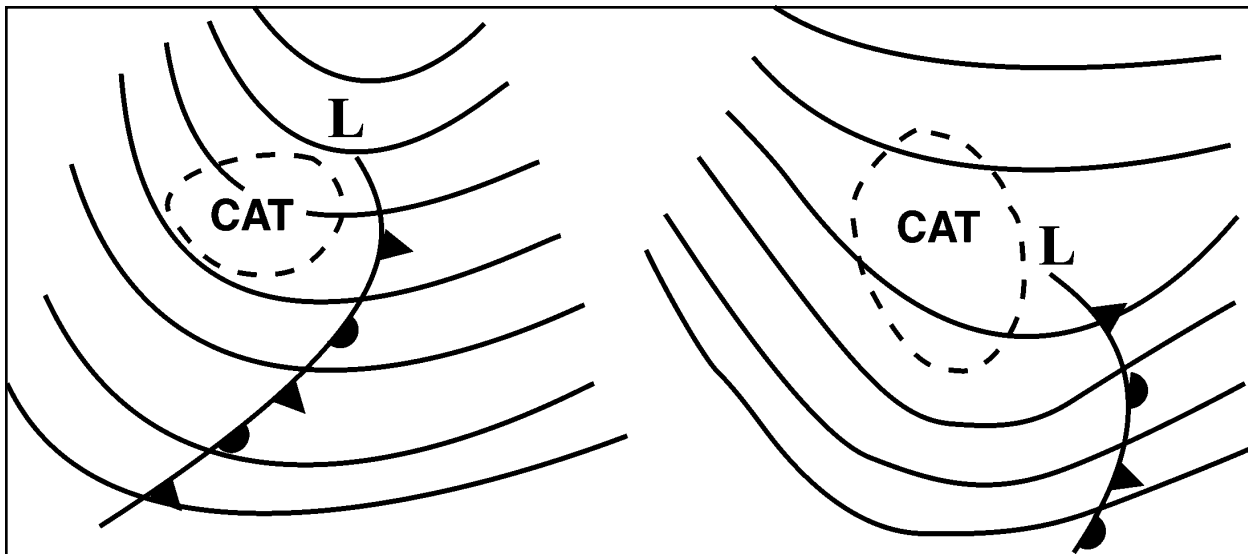

Figure 2-35. CAT and Diffluent Wind Patterns. The potential for CAT increases in the areas of diffluent flow near the surface system.

b. Diffluent Wind Patterns. Most CAT is observed during formation of diffluent upper-level wind patterns. After the diffluent pattern establishes, CAT may weaken in the diffluent zone. However, when a surface front is present (or forming), the potential for CAT increases in the areas of diffluent flow near the surface system (see Figure 2-35)

c. Strong Winds. CAT can exist in areas of strong winds when isotherms and contours are nearly parallel and only minor variations exist in wind direction (about 20° per 4 degrees of latitude) with exceptionally tight thermal gradients. Figure

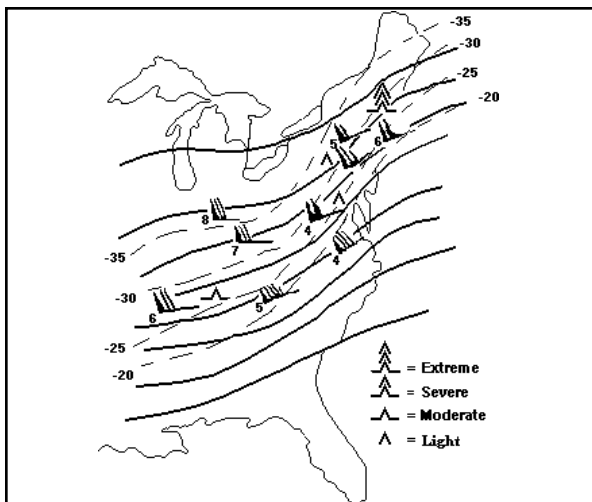

Figure 2-36. CAT and Strong Winds. Isotherms, 500-mb contours, and winds shown. Turbulence between FL180 and FL330.

2-36 illustrates a situation in which 500-mb winds exceeded 100 knots in the vicinity of a very high thermal gradient. CAT was observed between flight level of 18,000 feet (FL180) and FL330. Additionally, CAT often occurs along and above a narrow band of strong 500-mb winds when horizontal wind shears are strong on either side of the band, especially if the winds have an ageostrophic tendency.

d. Confluent Jets. When two jet stream cores converge to within 250 nm, the potential for CAT increases. Figure 2-37 shows the potential CAT area where two jets come within a distance of 5° latitude. Since the poleward jet is usually associated with colder temperatures and is lower than the second

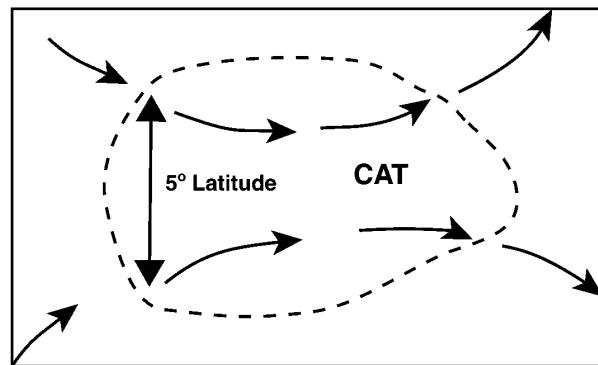

Figure 2-37. Turbulence with Confluent Jets. The CAT area occurs where two jets come within a distance of 5° latitude.

jet, the poleward jet will often undercut the other. This increases the static stability and produces strong vertical wind shears. The potential for CAT ends where the jets diverge to a distance of greater than 5° latitude.

3. Thermal Patterns. Analyze both the thermal and wind patterns to assess the potential for CAT. Appreciable cold-air advection is one significant clue to CAT potential.

a. Temperature Gradients at/above 300-mb. Expect CAT when a temperature gradient of greater than or equal to 5°C/120 nm exists or is forecast to occur and at least one of the following is observed:

- Trough movement greater than or equal to 20 knots.

- Wind shift greater than or equal to 75° in the region of cold advection.

- Horizontal wind shear greater than or equal to 35 knots/110 nm (~200 km).

- Wind component normal to the cold advection is greater than or equal to 55 knots.

b. Open-Isotherm Troughs. This situation encompasses the majority of the CAT patterns. The noticeable bulging of a cold-air tongue in a relatively tight thermal gradient may occur at or near the bottom of the trough. In either case, the isotherms curve more sharply than the contours (see Figures 2-38a-b and 2-39). In both cases, moderate turbulence was reported between FL250 and FL350.

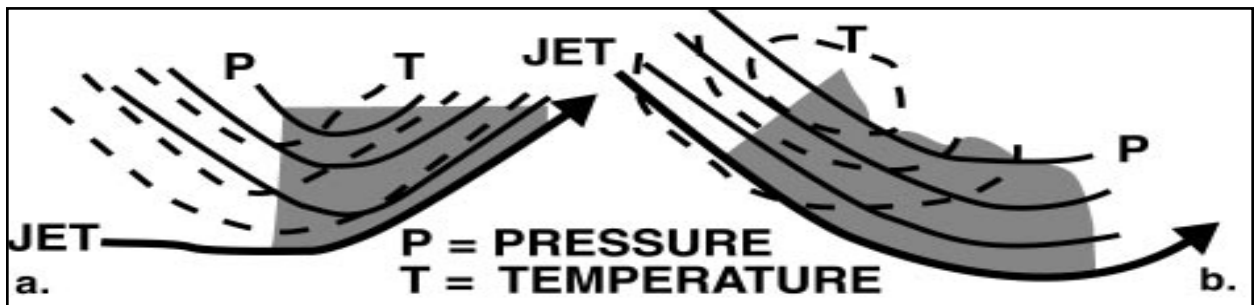

Figure 2-38. Two Basic Cold-Air Advection Patterns Conducive to CAT. Shaded areas highlight thermal patterns conducive to generation of CAT.

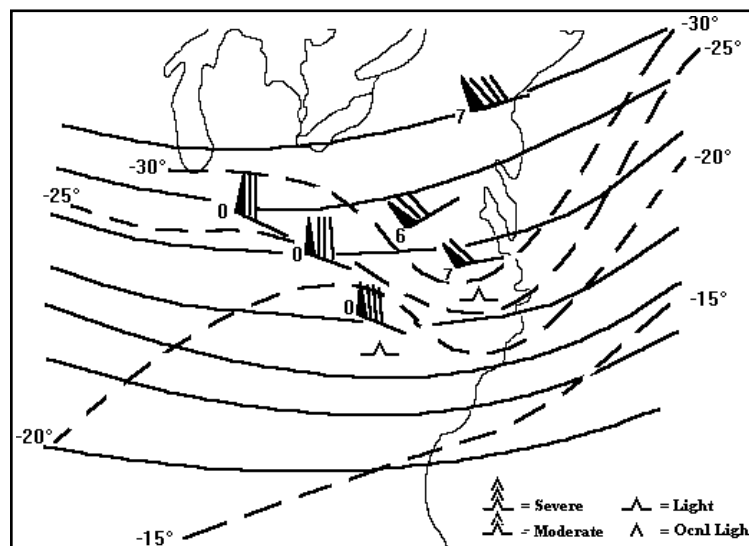

Figure 2-39. Common Open-Isotherm CAT. This situation encompasses the majority of the CAT patterns.

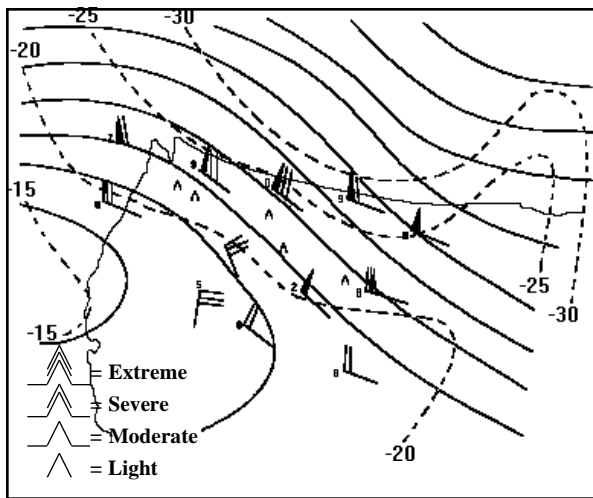

Figure 2-40a. CAT in Thermal Troughs. CAT was reported from FL 280 to FL 370.

Cold tongues commonly develop and move in from the northwest behind a pressure trough. Wind direction changes only gradually in this area. These troughs often move into the western states from the Pacific (see Figures 2-40a-b). Once the thermal configuration shown becomes apparent, check for development at higher levels. In Figure 2-40a, a trough and tongue of cold air at 300 mb extended across the indicated turbulence zone on a northwest-southeast line and was instrumental in creating the turbulence. The lack of turbulence indication in the strong CAA area in south central Canada probably is due to no PIREPS.

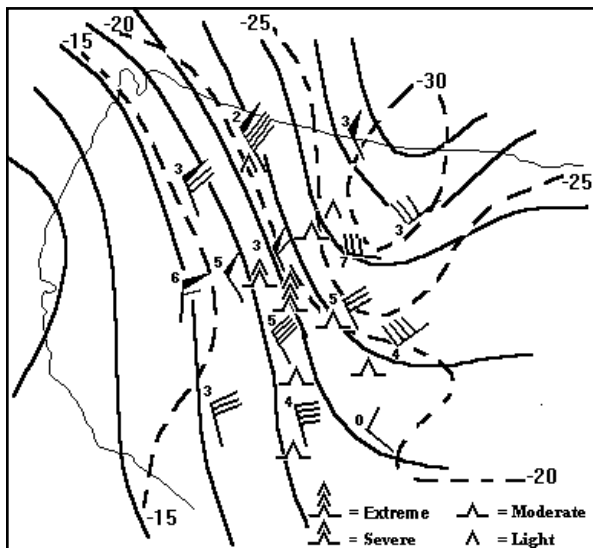

Figure 2-41. Closed Isotherm CAT. CAT was reported between FL240 and FL370.

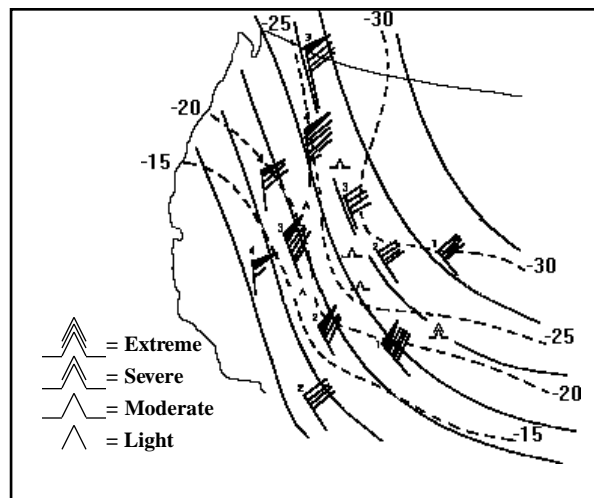

Figure 2-40b. CAT in Thermal Troughs. CAT was reported from FL 250 to FL 320 except over Utah where the report was at FL390.

Figure 2-40b shows a thermal gradient in combination with a smooth, strong wind flow pattern and a high isotherm amplitude. This pattern indicates a strong probability of CAT. The tight thermal gradient produced an average of 8 knots/1,000 feet of wind shear between 24,000 and 26,000 feet in Northern Utah. CAT began with a tightening thermal gradient. Strong winds, an abnormally tight thermal gradient, and higher amplitude isotherms than contours at 500 mb were strong indicators.

c. Closed Isothermal Patterns. CAT is often found in a moving, closed cold-air isotherm pattern at 500 mb when the height contours are not closed (see Figure 2-38b). CAT incidents between FL240 and FL370 were numerous (see Figure 2-41) in this rapidly moving pattern. The shear zone in the east region of the jet streak over the northern U.S. Rockies contributes to the CAT.

4. Troughs and Ridges.

a. Shearing Troughs. Rapidly moving troughs north of a jet may produce CAT in the confluent flow at the base of the trough (see Figure 2-42). The main area of CAT is north of the jet core.

b. Strong Wind Maximum to the Rear of the Upper Trough. CAT potential is high when a strong North-South jet is located along the backside of an upper trough. CAT usually occurs in the area of decreasing winds between the base of the trough and the maximum wind upstream. The change of

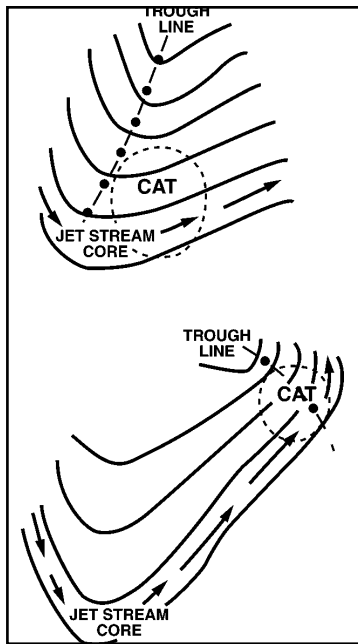

Figure 2-42. CAT and Shearing Troughs. The area of CAT is concentrated north of the jet stream core.

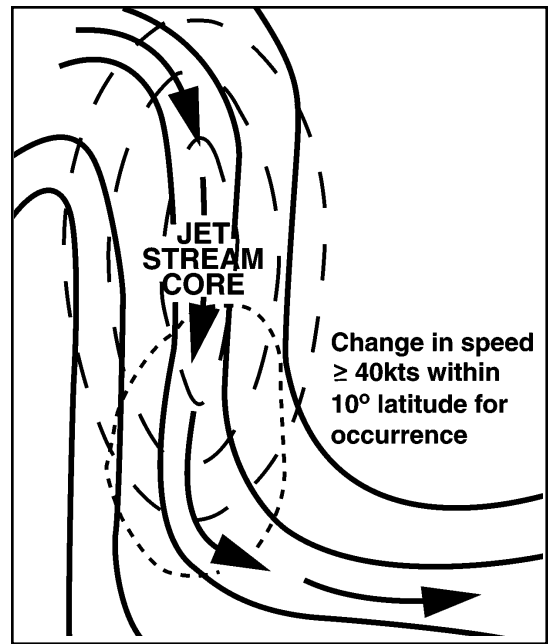

Figure 2-43. CAT Associated with Strong Wind Maximum to Rear of the Upper Trough. The potential is high when a strong North-South jet is located along the back-side of an upper trough.

wind speed should be greater than or equal to 40 knots within 10° of latitude for CAT to occur. If the difference between the jet core and the minimum wind speed is greater than or equal to 60 knots, CAT is most likely to occur between the jet core and the base of the trough, centered on the warm-air side of the jet (Figure 2-43).

c. 500-mb Deep Pressure Trough. A common configuration is a relatively deep pressure trough at 500 mb. CAT is often found in a sharply anticyclonic, persistent isotherm pattern downwind of the trough. In the example shown in Figure 2-44, the isotherms are sharply curved anticyclonically through eastern Mississippi and

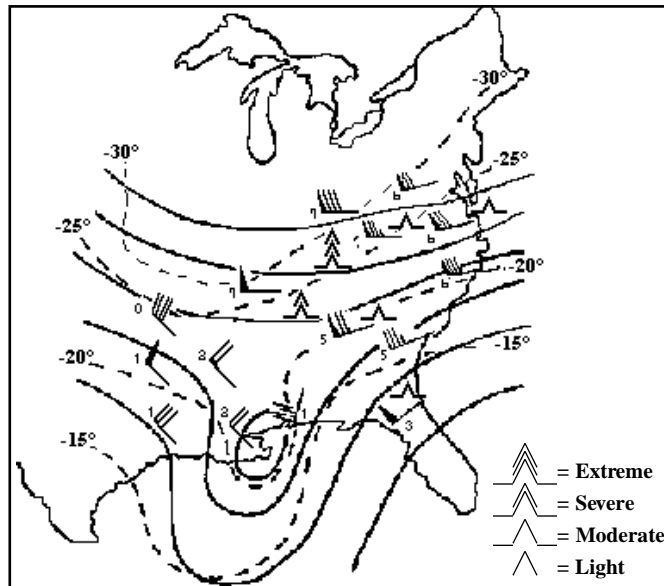

Figure 2-44. CAT in a Deep 500-mb Pressure Trough. CAT was reported between FL180 and FL 260.

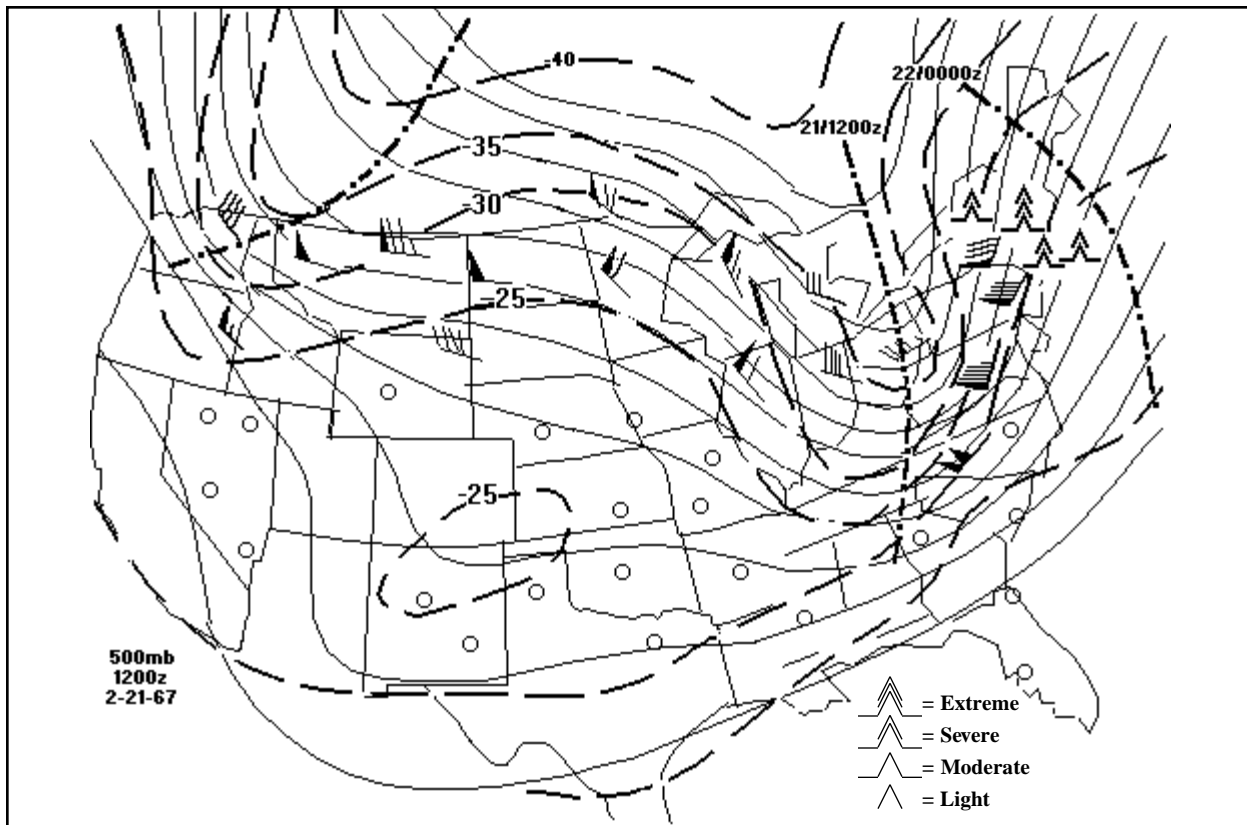

Figure 2-45. Double Trough Configuration. Moderate to extreme CAT was reported between 18,000 and 30,000 Feet (MSL)

Alabama, and the amplitude of the isotherms exceeds that of the contours. CAT was found downwind from the sharp curvature in the isotherms lee of the trough between FL180 and FL260.

d. Double Trough Configuration. Strong CAT is often associated with two troughs when they are close enough together that the trailing trough influences the airflow into the leading trough. This common pattern is often associated with a flat or flattening intervening ridge, which advects warm air into the bottom of the lead trough. Although the double trough can be detected at a number of levels, the 500-mb product is the best to use. Figure 2-45 depicts two troughs that are quite far apart. Nevertheless, the trailing trough exerts a definite influence on the airflow into the leading trough. Moderate to extreme CAT was reported between FL180 and FL300.

e. Upper-Level Ridges. Expect at least moderate CAT on both sides of the jet near the area where the jet undergoes maximum latitudinal displacement in an amplifying ridge (see Figure 2-

46). Maximum CAT is located in the area of greatest anticyclonic curvature (usually within 250 nm of the ridge axis and elongated in the direction of the flow). Expect moderate or greater CAT with the following conditions (cyclogenesis may also occur downstream of these upper-level features):

- Strong vertical wind shear greater than or equal to 10 knots/1,000 feet.
- Winds greater than 135 knots in an area of large anticyclonic curvature.
- Large latitudinal displacement of the jet with winds greater than 115 knots.

5. Uses of Upper-Air Data to Forecast CAT. Here are some hints for using upper-air products to pick out synoptic conditions favorable for CAT, as described elsewhere.

a. 700- and 850-mb Height and Temperature Fields. These tools are useful in identifying regions of thermal advection, wind components normal to

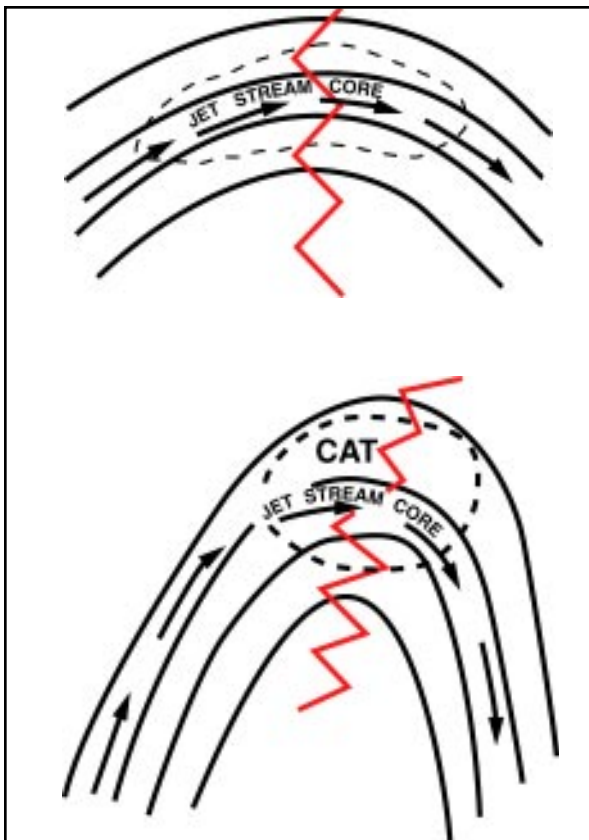

Figure 2-46. CAT and Upper-Air Ridges. Maximum CAT is located in the area of greatest anticyclonic curvature.

mountain ridges, mid- or low-level turbulence, and upper-level frontal boundaries.

b. 500-mb Analysis of Heights, Temperature, and Vorticity. Key on areas of thermal advection, shortwave troughs, and wind components perpendicular to mountain ridges. A 500-mb chart can also be used to approximate jet stream positions and the general upper-air synoptic pattern. For example, place jets near the following isotherms:

- Subtropical jet -11°C
- Polar front jet -17°C
- Arctic jet -30°C

c. 250-mb Jet Steam. Analyze closely to determine the current and future jet stream core position.

d. 200-mb Analyzed Height and Temperature Fields. Look for regions of strong isotherm packing in association with strong wind flow. The 200-mb isotherms correspond closely with the 500-mb vorticity pattern and clearly depict short waves and developing systems.

E. MOUNTAIN WAVE (MW) TURBULENCE.

The most severe type of terrain-induced turbulence is mountain wave turbulence. It often occurs in clear air and in a stationary wave downwind of a prominent mountain range. It is caused by the mechanical disturbance of the wind by the mountain range.

The sketch in Figure 2-47a shows a foehn gap, indicating turbulent lee waves are present. The gap is located between the cirrus clouds and mountain range on the leeward side of the range. Wave intensity depends on several factors:

- Wind speed.
- Height and slope of the mountain (high mountains with steep slopes produce the most intense turbulence).
- Stability of the lower troposphere above and to the lee of the mountain (the most intense turbulence is associated with stable air above and to the lee of the mountain barrier).

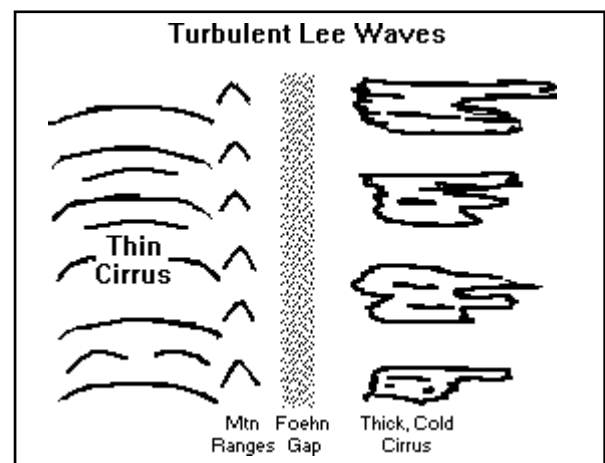

Figure 2-47a. Mountain-Wave Clouds. A foehn gap, indicates turbulent lee waves are present.

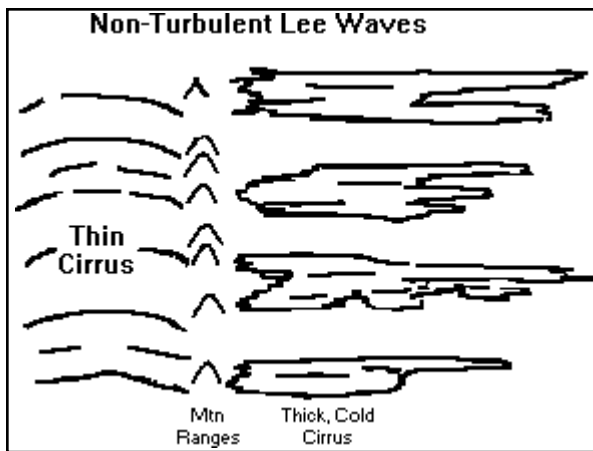

Figure 2-47b. Mountain-Wave Clouds. The lack of a foehn gap indicates the absence of turbulent lee waves.

The most dangerous turbulence is found in the rotor and cap clouds. Downdrafts in these clouds can force a plane into a mountain. The sketch in Figure 2-47b has no foehn gap; the clouds nestle against the mountain range on the leeward side. This indicates an absence of turbulent waves.

A necessary ingredient for severe mountain wave development is a minimum wind component of 25

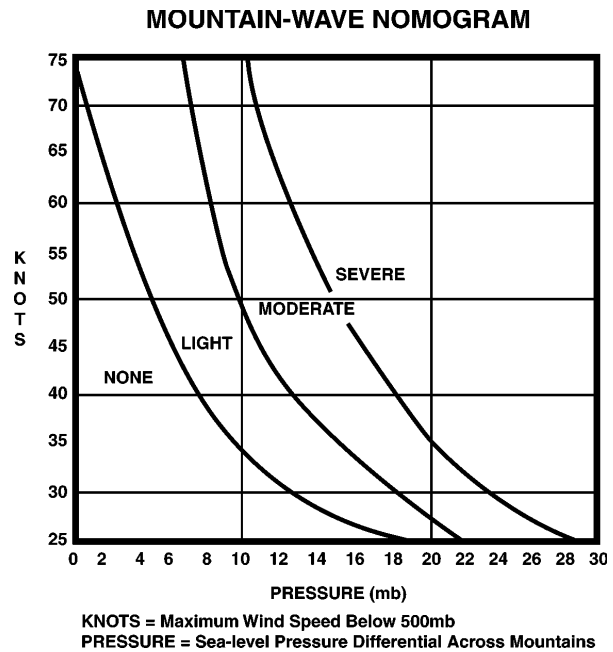

Figure 2-48. Mountain-Wave Nomogram. Use this nomogram to predict mountain wave intensity.

knots perpendicular to the mountain ridge at the height of the ridge. Also, the wind profile should include little change of wind direction with height and increasing wind speeds with altitude high into the troposphere. Table 2-9 and Figure 2-48 (used together), provide guidance in forecasting mountain-wave turbulence.

Table 2-9. Low-level mountain wave turbulence.

Low-Level Mountain-Wave Turbulence (Surface To 5,000 Ft Above Ridge Line)			
Low-Level Feature	Turbulence Intensity		
	Light	Moderate	Severe
Wind Component Normal to Mountain Range at Mountain Top and > 24 kt and			
dP Across Mountain at Surface is	See Figure 2-48	See Figure 2-48	See Figure 2-48
dT Across Mountain at 850 mb is	< 6°C	6°C - 9°C	> 9°C
dT/dX Along Mountain Range at 850 mb is	<4°C/60 NM	4-6°C/60 NM	>6°C/60 NM
Lee-Side Surface Gusts	< 25 kt	25 - 50 kt	> 50 kt
Winds Below 500 mb > 50 kt	Increase the Turbulence found by one degree of intensity (i.e., Moderate to Severe)		

- Notes:**
- (1) dP is the change in surface pressure across the range.
 - (2) |dT| is the absolute value of the 850-mb temperature difference across the range.
 - (3) |dT/dX| is the absolute value of the 850-mb temperature gradient along mountain range.
 - (4) Turbulence category forecast is the worst category obtained from each of the four parameters.

1. Associated Clouds. There are specific clouds associated with mountain wave turbulence. These are cap (foehn wall), roll (rotor), lenticular, and “mother-of-pearl” clouds. Figure 2-49 illustrates the structure of a strong mountain wave and associated cloud patterns. The lines and arrows depict windflow.

a. Cap Cloud. The cap cloud hugs the tops of mountains and flows down the leeward side with the appearance of a waterfall. This cloud is dangerous because it hides the mountain and has strong downdrafts associated with it. The downdrafts can be as strong as 5,000 to 8,000 feet per minute.

b. Roll Cloud. The roll cloud, also called a rotor cloud, looks like a line of cumulus clouds parallel to the ridge line. It forms on the lee side and has its base near the height of the mountain peak and top near twice the height of the peak. The roll cloud often merges with the lenticular clouds above, forming a solid cloud mass to the tropopause. The roll cloud is dangerously turbulent with strong

updrafts (5,000 feet per minute) on the windward side and dangerous downdrafts (5,000 feet per minute) on its leeward edge. This cloud may form immediately on the lee of the mountain or it may be a distance of 10 miles downwind – depending on wind speed.

c. Lenticular Clouds. Lenticular clouds are relatively thin, lens-shaped clouds with bases above the roll cloud. Their tops extend to the tropopause. These clouds have a tiered or stacked look due to atmosphere stability above the mountain ridge. All lenticular clouds are associated with turbulence. In polar regions, lenticular clouds can appear in the stratosphere as high as 80,000 feet. These clouds are called “mother-of-pearl” (nacreous) clouds.

2. Occurrence Indicators.

- Rapidly falling pressure to the lee side of mountains.
- Broken or ragged-edged ACSL reported to the lee of the mountains.

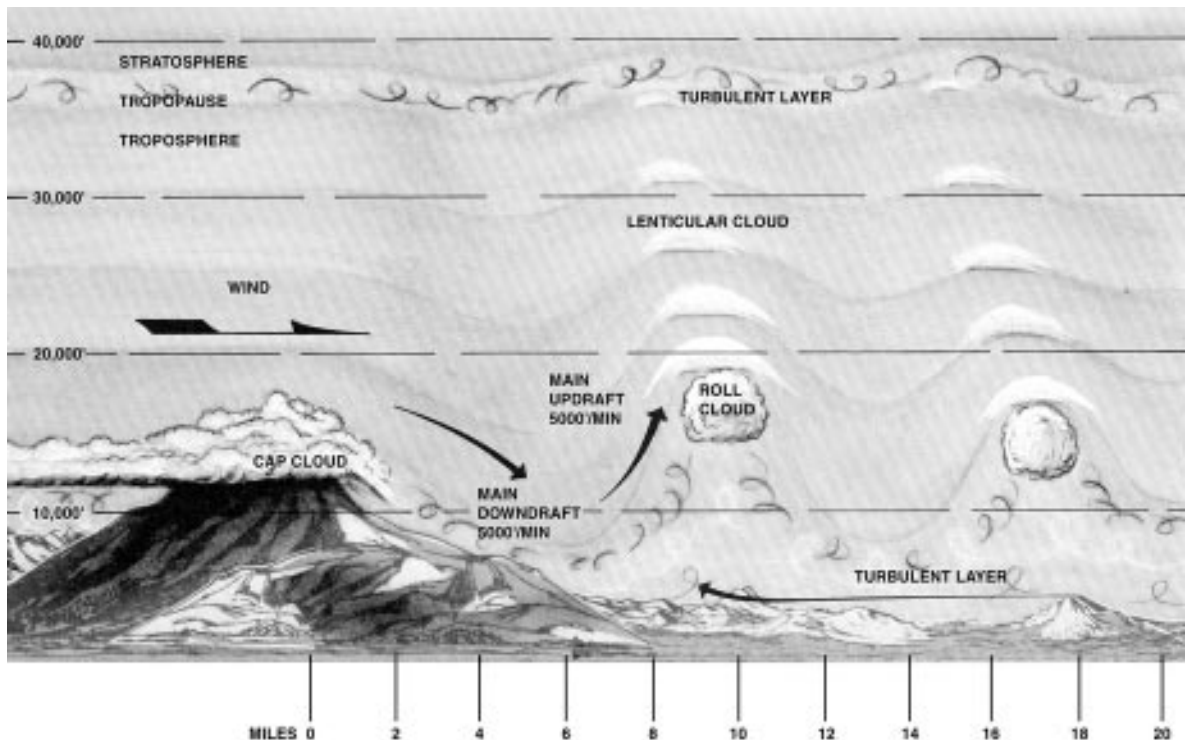

Figure 2-49. Mountain-Wave Cloud Structure. The figure illustrates the structure of a strong mountain wave and associated cloud patterns. The lines and arrows depict windflow.

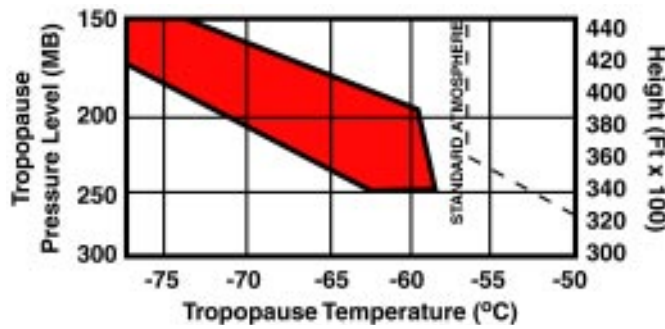

Figure 2-50. Graph of Mountain-Wave Potential. When tropopause temperature and height readings fall within the shaded area, the potential for mountain-wave turbulence exists when the wind speed and direction criteria are met.

- Lee side gusty surface winds at nearly right angles to the mountains.
- Blowing dust picked up and carried aloft to 20,000 feet MSL or higher.
- Temperature of -60°C or less in the upper atmosphere near the mountain-wave zone (see Figure 2-50).

F. WAKE TURBULENCE. Although neither forecasted nor recorded in a TAF, wake turbulence is a problem with the increased use of heavy aircraft. You should be aware of how wake turbulence forms and be aware of its effects.

1. Characteristics. Every aircraft generates two counter-rotating wingtip vortices. Wake turbulence results when an aircraft encounters vortices from another aircraft. Vortex generation begins when the nose wheel lifts off the ground and ends when the nose touches back down again during landings. A vortex forms at each wingtip as air circulates outward, upward, and around the wingtip. The diameter of the vortex core varies with the size and weight of the aircraft.

These vortices can be 25 to 50 feet in diameter with a much larger area of turbulence. They usually stay fairly close together (about $3/4$ of the wing span) until dissipation. They sink at a rate of 400 to 500 feet per minute and stabilize about 900 feet below the flight path, where they begin to dissipate. Vortex

size is reduced by the use of winglets, smaller “wings” that curve upward from aircraft wing tips.

2. Dissipation. Atmospheric turbulence increases the dissipation of wake turbulence while ground effect and surface winds alter the low-level vortex characteristics only slightly. As the vortex sinks into the boundary layer, it begins to move laterally at about 5 knots. A crosswind will decrease the lateral movement of a vortex moving toward the wind and increase the movement of a vortex moving with the wind. This could hold one of the vortices over the runway for an extended period or allow one to drift onto a parallel runway. Vortices persist longer during inversions.

Listed below are some rules for avoiding wake turbulence (Federal Aviation Administration (FAA) Aeronautical Information Manual):

- Stable conditions combined with a crosswind of about 5 knots may keep the upwind vortex over the runway for periods of up to 15 minutes.
- Vortex generation begins with lift-off and lasts until touchdown. Therefore, aircraft should avoid flying below the flight path of a recent arrival or departure.
- If two aircraft fly in the same direction within 15 minutes of each other, the second should maintain an altitude equal to or higher than the first. If required to fly slightly below the first, the second aircraft should fly upwind of the first.

G. FORECASTING AIDS. Use the following list of checklists, figures, standard system tools, and tables provided to aid you in providing accurate turbulence forecasts.

1. Location of Turbulence Conditions. The general location of turbulence should be anticipated in the following areas:

- Thunderstorms
- Areas of strong thermal advection, such as:
 - Cold-air advection.
 - Warm-air advection.
 - Strong upper-level fronts.
 - Rapid surface cyclogenesis.
 - Outflow area of cold digging jet.
- Areas of considerable horizontal directional and/or speed shear, such as in:
 - Mountain areas.

- Diffluent upper flow.
- Developing cutoff lows.
- Sharp anticyclonic curvature.
- Areas of considerable vertical shear, particularly below strong stable layers in:
 - Tilted ridges.
 - Sharp ridges.
 - Tilted troughs.
 - Confluent jet streams.

2. Basic Forecasting Checklist for Low-Level (Surface to 10,000 Feet) Turbulence. Low-level turbulence can dramatically impact flight operations. Aircrews operating in high speed, low altitude training routes must be prepared to make quick corrections to avoid catastrophic accidents (see Figure 2-51).

Note: Checklist is based on Category II aircraft. Adjust turbulence values for supported aircraft using Tables 2-7 and 2-8.

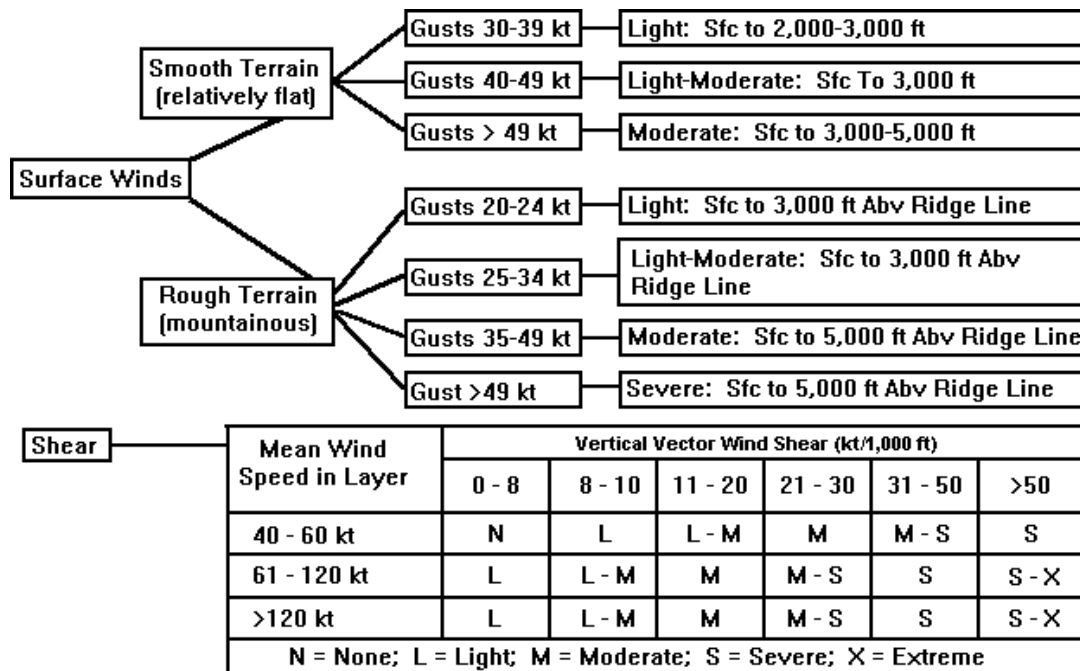

Figure 2-51. Forecasting Checklist for Low-Level Turbulence. This checklist is designed for Category II aircraft.

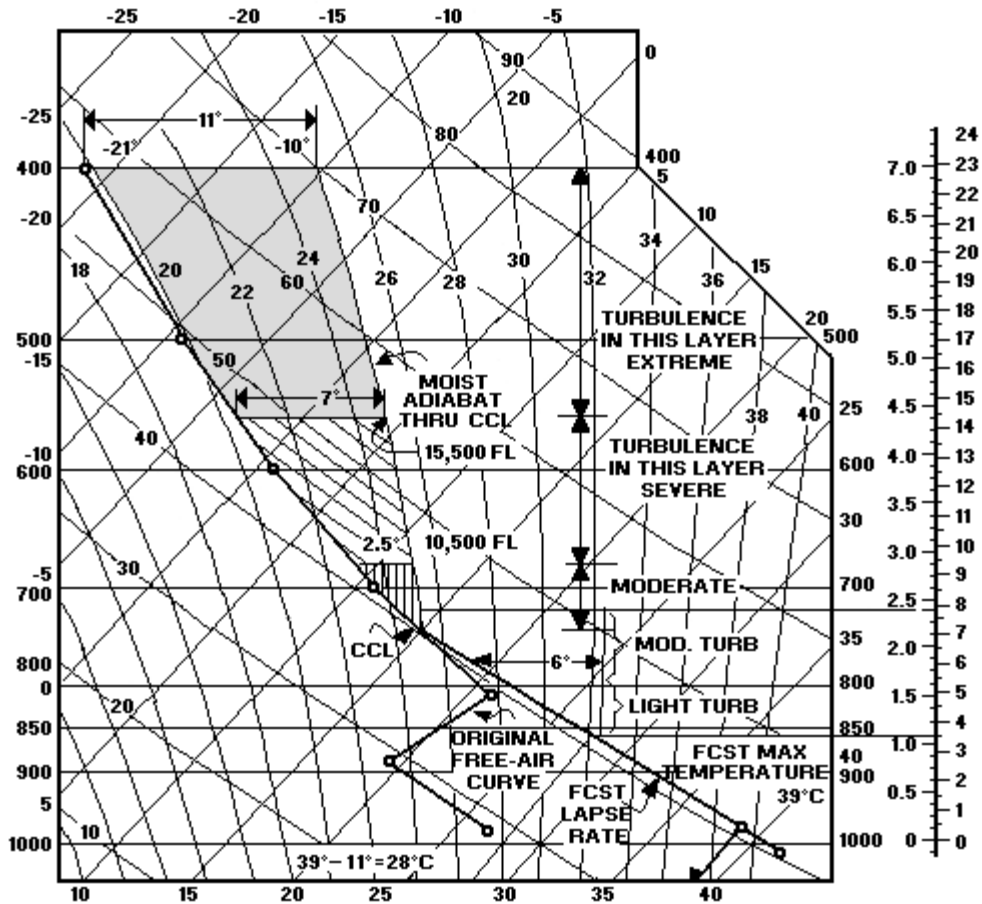

Figure 2-52. Turbulence Forecasting from Skew-T. The figure depicts a method for forecasting turbulence in convective clouds using a Skew-T.

3. Forecasting Turbulence in Convective Clouds. This section describes a method for forecasting turbulence in convective clouds using a Skew-T. The method considers two layers of the atmosphere: surface to 9,000 feet MSL and above 9,000 feet MSL (see Figure 2-52). The forecast is designed for Category II aircraft and must be modified for other types of aircraft.

a. Layers from Surface to 9,000 feet. Use the steps below to estimate the buoyant potential in the lower atmosphere. Use the results obtained from this method to estimate turbulence in thunderstorms.

- Use the convective temperature to forecast the maximum surface temperature. Project a dry adiabat from the CCL to the surface. This gives the convective temperature. Adjust this temperature using temperature curves for local effects.

- Subtract 11°C from the final forecast maximum temperature. Follow this isotherm to its intersection with the dry adiabat projected upward from the forecast maximum temperature.

If the intersection is above 9,000 feet MSL, forecast no turbulence below 9,000 feet MSL. If the intersection is below 9,000 feet, draw a moist adiabat from the intersection of the isotherm and the dry adiabat upward to the 9,000-foot level. The temperature difference between this moist adiabat and the free-air temperature curve determines the severity of the turbulence as well as the limits of the layers of each degree of turbulence. Apply the temperature differences to Table 2-10.

b. Layers Above 9,000 Feet. Follow the moist adiabat that passes through the CCL upward to the 400-mb level. The maximum temperature difference between this moist adiabat and the forecast free-air temperature curve is the central

Table 2-10. Layers below 9,000 feet using temperature differences.

Layers Where Temperature Difference is	Turbulence is Forecast as
0° to 6°C	Light
6° to 11°C	Moderate
11°C or More	Severe

Table 2-11. Layers above 9,000 feet using temperature differences.

Layers Where Temperature Difference is	Turbulence is Forecast as
0° to 2.5°C	Moderate
2.5° to 7°C	Severe
7°C or More	Extreme

portion of the most turbulent area. The intensity of the turbulence is found in Table 2-11.

graph in Figure 2-53 can be used to predict turbulence using forecast or observed winds and the temperature differences across a surface front.

4. Low-Level Turbulence Nomogram. The

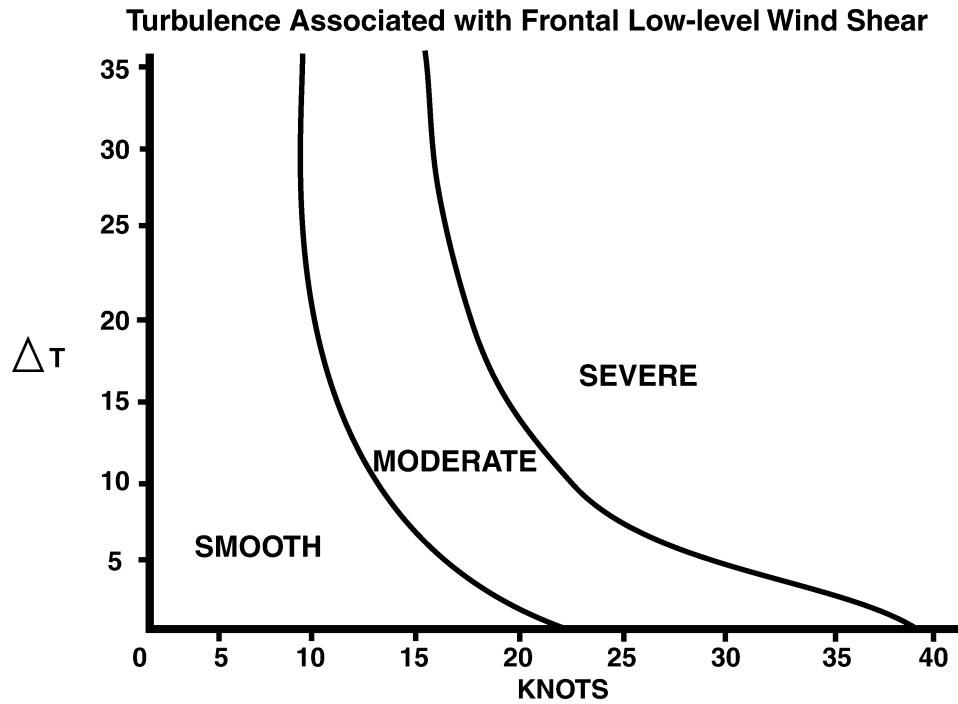

ΔT = Temperature difference across front at surface. (Deg F/50nm)
 KNOTS = Sustained surface wind speed, forecast or observed

Figure 2-53. Turbulence Nomogram—Temperature Gradient and Surface Winds. Use this figure to predict turbulence using forecast or observed winds and temperature differences across a surface front.

Table 2-12. Wind shear critical values.

	Turbulence Intensity			
	Light	Moderate	Severe	Extreme
Horizontal Shear		25-49 kt/90 NM	50-89 kt/90 NM	> 90 kt/90 NM
Vertical Shear	3-5 kt/1,000 ft	6-9 kt/1,000 ft	10-15 kt/1,000 ft	> 15 kt/1,000 ft

5. Wind Shear Critical Values. Use Table 2-12 if receiving PIREPs with turbulence for a particular area and you want to quickly confirm if the turbulence will likely continue in the area. When two of the criteria are present in the same region, forecast the higher turbulence intensity (e.g., if moderate horizontal criteria and severe vertical criteria are present in the same region, forecast severe turbulence in this region).

6. Significant Parameter Checklist. This checklist (see completed checklist in Table 2-13) lists significant turbulence-producing parameters arranged in three situations. Use situations Ia or b,

II, and III over land. For over water use, only Ib applies.

- Situation I: high-level wind and temperature field.
- Situation II: terrain parameters.
- Situation III: gravity wave atmospheric parameters.

Note: If a parameter is only marginally suitable for turbulence, enter an “X” in the suitability column; enter two “X’s” if a parameter is strongly

Table 2-13. Significant Parameter Checklist.

Situation		Parameter	Suitability	Remarks
High-level wind and Temperature Fields	Ia	Vertical shear (jet stream vicinity)	XX	Strong double jet stream
		Cyclonic shear (cyclonic side of jet)	X	Approximately under jet stream; difficult specify shear
		Vicinity of tropopause		Well below tropopause
		Low static stability (destabilizing differential advection)	XX	Moderate cold-air advection at 300 mb but not at 500 mb
		Cyclonic curvature and diffluence (troughs and exit regions)	X	Trough to west; difficult to determine diffluence pattern
	Ib	Vertical shear (jet stream vicinity)		
		Anticyclonic shear		
		Anticyclonic curvature		
		Low static stability (destabilizing differential advection)		
		Exit region of isotach maximum		
Terrain Parameters		Height of ridge (presence of ridge)	X	Not high
	II	Ridge well-defined sharp	XX	
		Series of well-spaced ridges	XX	
Gravity wave parameters	III	Strong low-level winds	XX	About 25 kt
		Low-level winds normal to ridge	XX	Winds 290° - ridge 200-020
		Increasing wind with height (strong winds aloft)	XX	
		Little change of direction with height	XX	Only about 20-30 degrees
		Low-level unstable layer (cold-air advection)	XX	Surface to 850 mb
		Intermediate stable layer and less stable above	XX	

suitable for turbulence. The more “X’s” in the suitability column, the greater the turbulence occurrence and severity. Stations should determine their own thresholds for what number of “X’s” are significant to their operations. In the example above, several aircraft experienced severe turbulence; one aircraft crashed.

7. NESDIS CAT Tool. The National Environmental Satellite, Data, and Information (NESDIS) decision tree in Figures 2-55 through 2-61 helps produce a turbulence forecast from hourly satellite infrared images, daytime visible and water vapor channel images, and rawinsonde wind and temperature observations (or 6- to 12-hour forecasts), at standard levels. In order to correctly use the decision tree, first understand both the dynamics that cause turbulence and satellite imagery analysis techniques. Be familiar with and recognize the following features:

a. Deformation Zone. A region where the atmosphere is undergoing contraction in one direction and elongation or stretching in the perpendicular direction, relative to the motion of the air stream (see Figure 2-54). A cloud border is often located near and parallel to the stretching axis. Situations where moderate to severe turbulence is most likely are as follows:

- Low and associated comma-cloud system is dissipating.
- A flattening of the cloud border on the upstream side of the comma.
- Cyclogenesis is in progress, accompanied by a building or rapidly moving upper ridge to the east of the storm.
- The cloud system is encountering confluent (opposing) flow caused by a blocking upper-level system (a closed low or anticyclone) downstream.

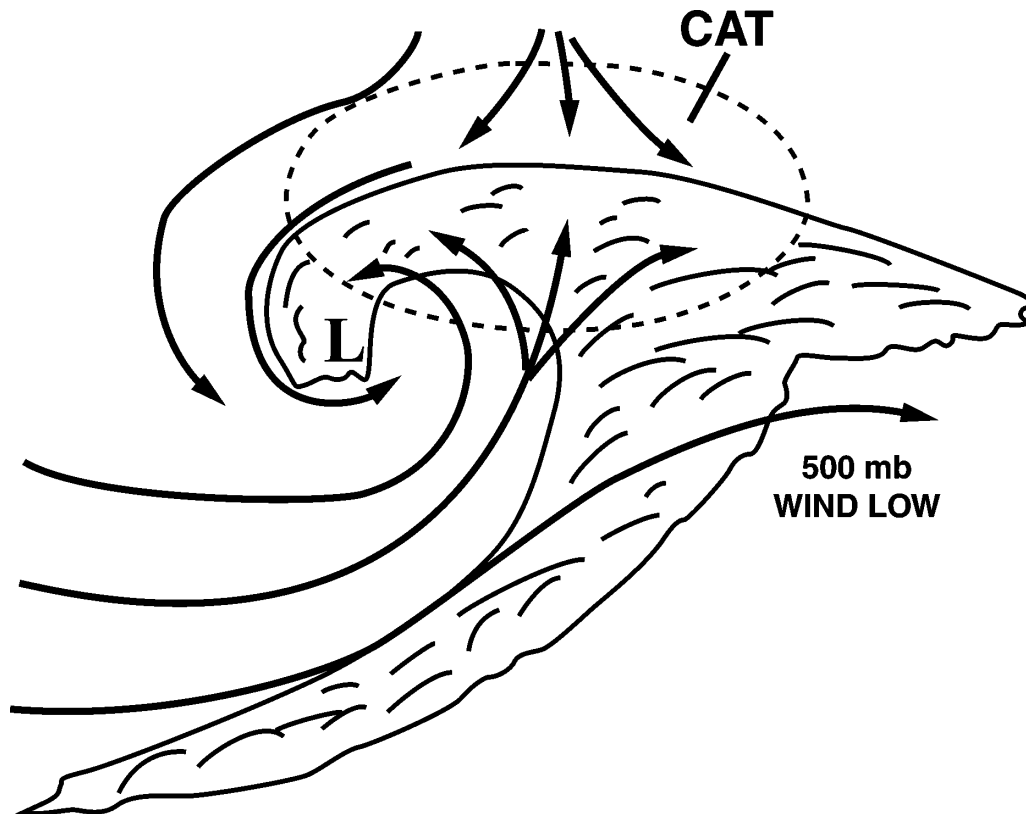

Figure 2-54. CAT in a Deformation Zone. Moderate to severe turbulence can occur in the dotted area.

Chapter 2

b. Wave Cloud Signatures.

(1) *Transverse Bands.* Defined as irregular, wavelike cirrus cloud patterns that form nearly perpendicular to the upper flow. They are usually associated with the low latitude subtropical jet stream and indicate large vertical and possibly horizontal wind shears. Generally, the wider, thicker transverse bands are more likely to contain severe turbulence, possibly due to the added presence of thermal instability. In these situations, the bands often have a carrot-shaped appearance, similar to cumulonimbus anvils. Cloud bands, in general, tend to be aligned with the cloud layer shear vector. For this reason, the presence of cirrus bands which differ in orientation from the prevailing wind direction (transverse to the flow) indicate directional shear with height.

(2) *Billows.* Defined as wave cloud patterns in cirrus, or middle-level clouds which are regularly spaced, narrow, and oriented to the upper flow. They are most often seen when a strong jet intersects either a frontal cloud system or a line of cumulonimbus clouds at a large crossing angle. The anvil debris of convective clouds in these situations extends well downstream from its source. Although individual waves dissipate quickly (less than 30 minutes), new waves can reform nearby under favorable conditions. The longer the wavelength of the billows, the better the chance for significant turbulence. Kelvin-Helmholtz instability is often made visible in billow clouds.

(3) *Water Vapor Image Darkening.* This refers to elongated bands, or in some cases, large oval-shaped gray regions that become darker in successive images. The darkening is usually accompanied by cold advection and convergence in the mid- and upper-levels of the troposphere resulting in compensating sinking through a deep layer. Cross sections of such features reveal sloping baroclinic zones (tropopause leaves or folds). This indicates stratospheric air is descending into the

upper troposphere. Moderate or stronger turbulence occur 80 percent of the time when image darkening occurs, especially if it persists for at least 3 hours.

(4) *Mountain Waves.* Defined as stationary waves situated downwind of a prominent mountain range and caused by the disturbance of the wind by the mountain range. Usually the wave appears as a stationary, narrow clearing zone parallel to steep mountain ranges. It may also occur in foehn wind synoptic situations, near or just east of the upper ridge and south of the jet stream.

(5) *CAT Decision Tree.* The decision tree summarizes subjective and objective techniques developed by NESDIS (see Figures 2-55 through 2-59). The decision tree starts with an assessment of the upper-level synoptic flow pattern over the area of interest and then asks questions about features observed in satellite imagery. Sketches are included to help visualize the image features or flow patterns being described. The decision tree has built-in redundancy. If a mistake is made in the analysis of the synoptic flow pattern, it is still possible to arrive at the correct solution. Sketches are included to help visualize the image features or flow patterns being described.

Confidence levels are stated when a solution level is reached. The estimates are based on a study completed by NESDIS. In most cases confidence levels range from 50 to 80 percent. Confidence level is usually lowest in mountainous regions where turbulence may occur without any conspicuous satellite image features.

Turbulence intensities are Light (L), Moderate (M), and Severe (S). The intensities have been determined from numerous large commercial and military aircraft pilot reports. A solution of Moderate Or Greater (MOGR) means that moderate turbulence is likely and severe turbulence is possible. A solution of "M-S" means that moderate to occasional severe turbulence is likely.

Turbulence Decision Tree

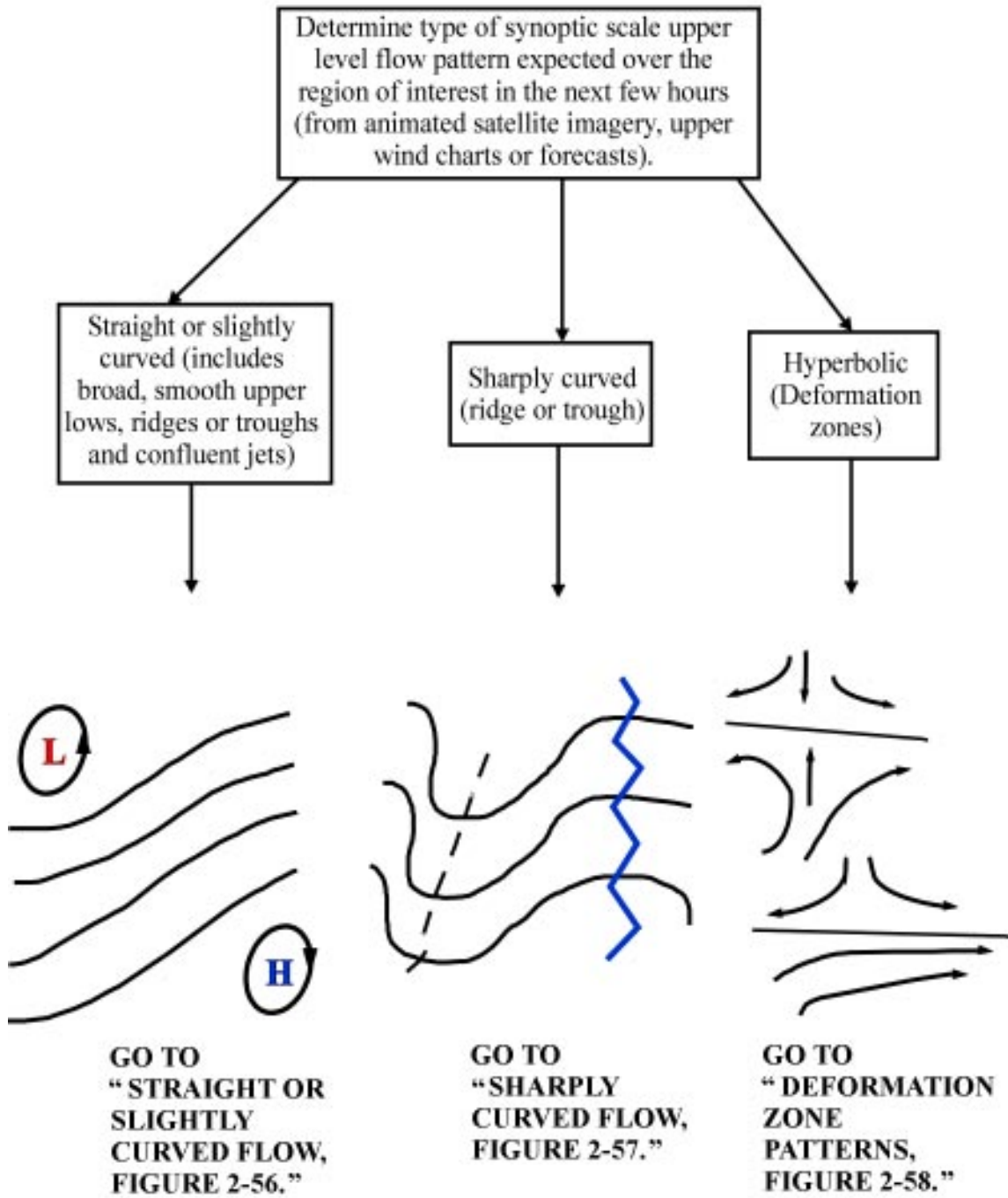

Figure 2-55. Clear-Air Turbulence Decision Tree.

Straight or Slightly Curved Flow

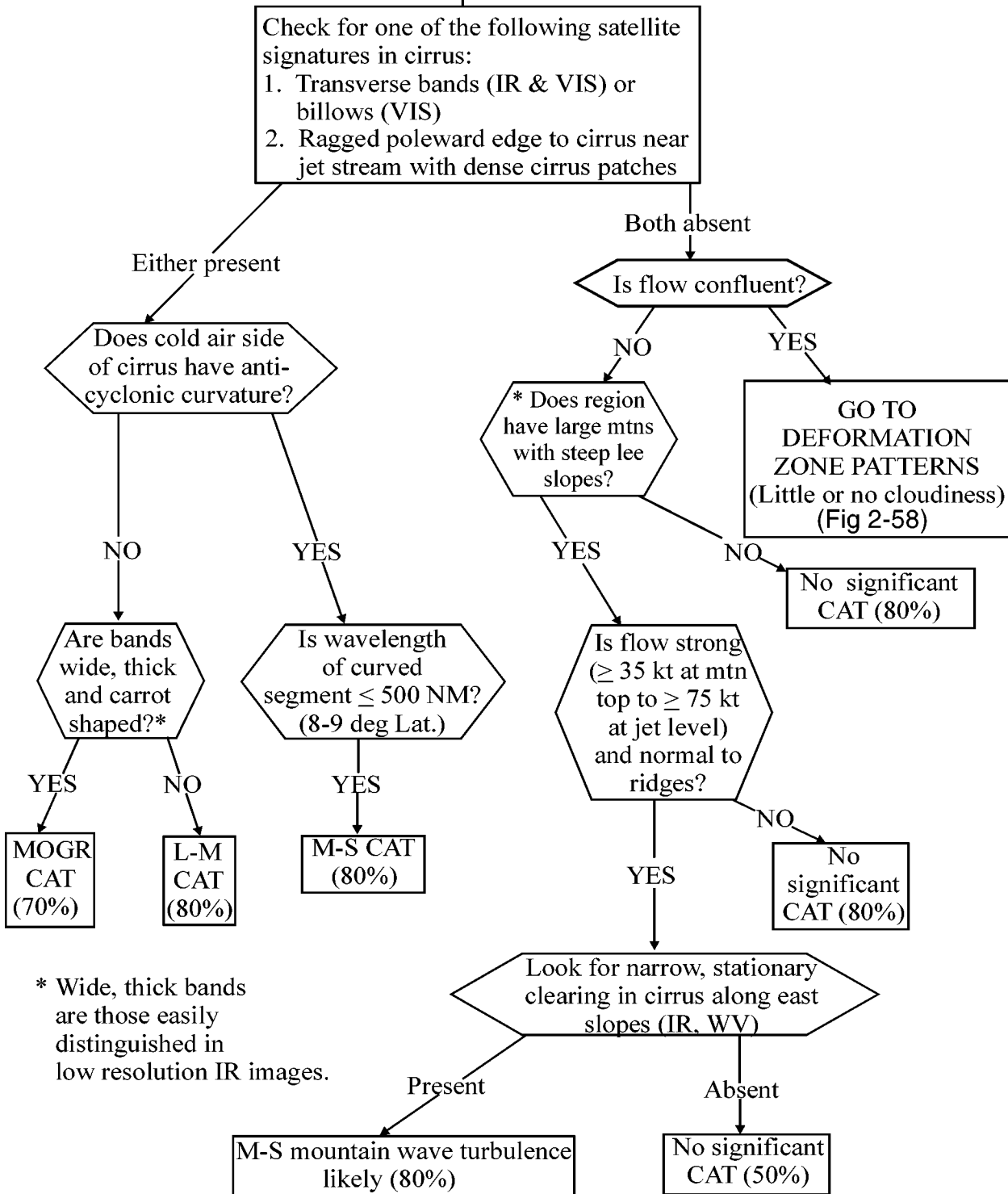
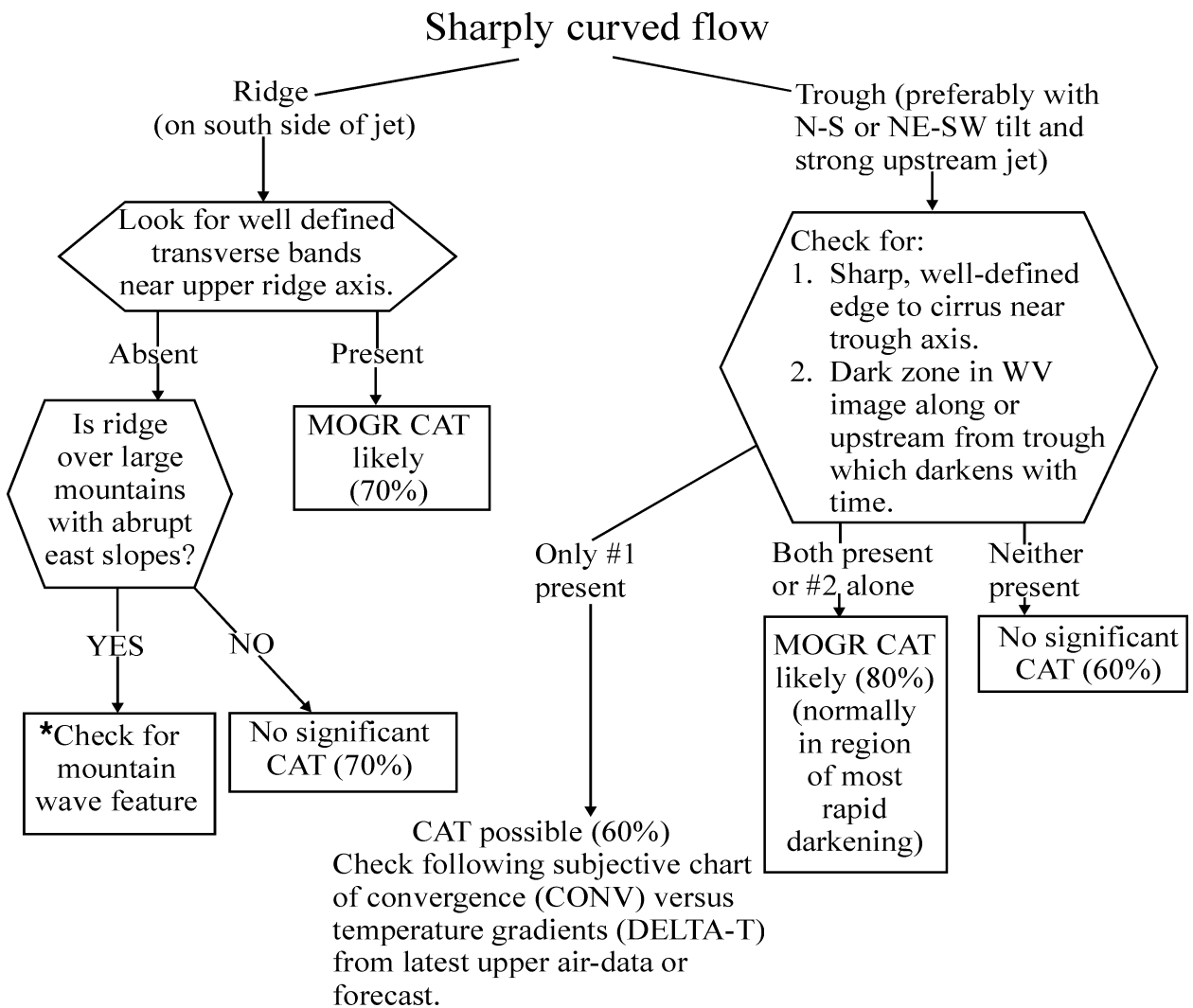

Figure 2-56. CAT Forecasting—Straight or Slightly Curved Flow.



CONV ¹	DELTA-T ²	CAT
Strong	Large	M-S
Strong	Small	M
Moderate	Large	M
Moderate	Small	L-M
Weak	Large	L-M
Weak	Small	None

¹ Strong CONV is defined as a deceleration of about 50 knots (25 m/sec) in 4 degrees latitude. Moderate CONV would occur with about a 35 knot deceleration.

* (Go to * in Figure 2-56) ² Large DELTA-T is >4°C/180 NM (3 degrees latitude).

Figure 2-57. CAT Forecasting—Sharply Curved Flow.

Deformation Zone Patterns

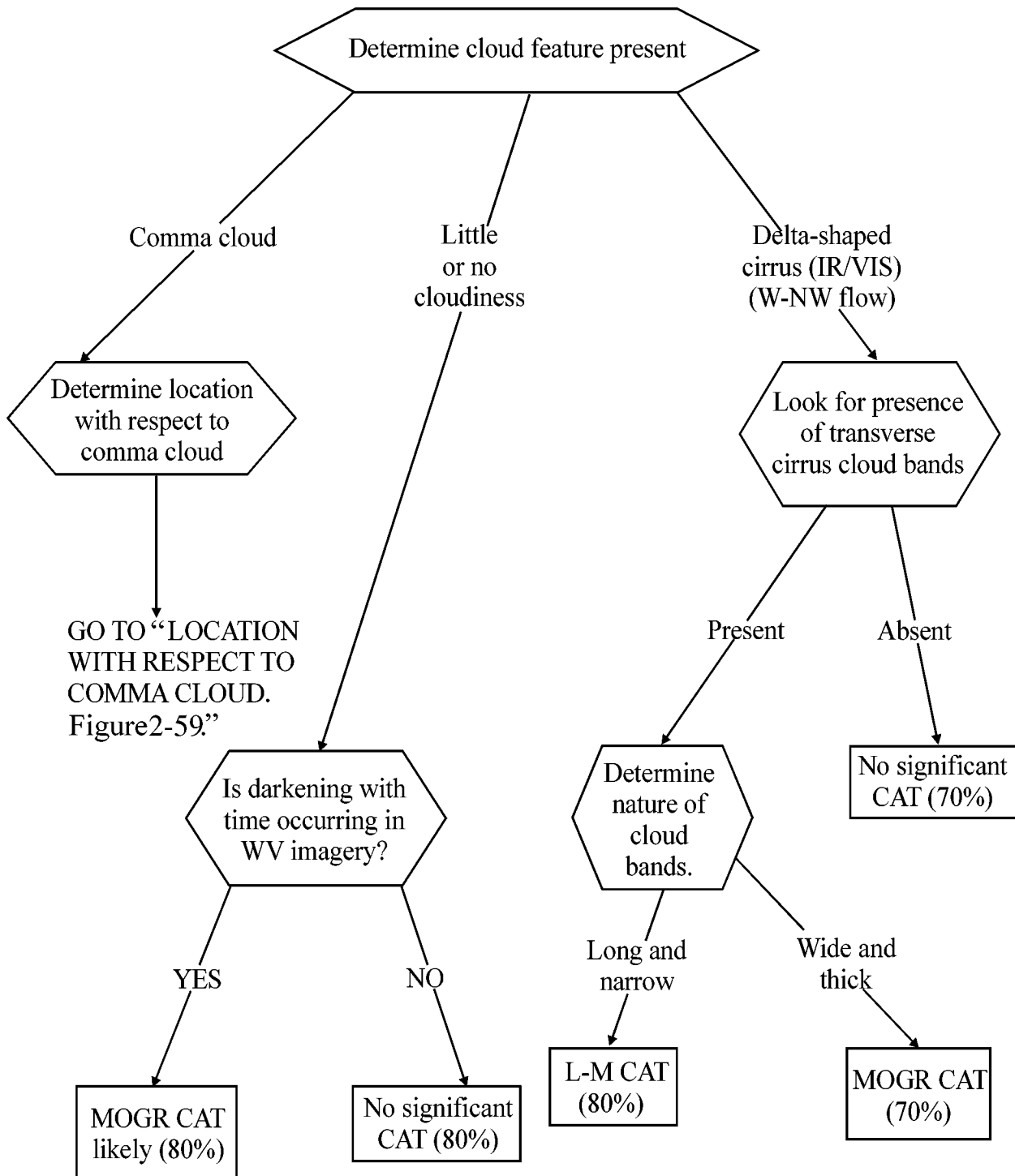

Figure 2-58. CAT Forecasting—Deformation Zone Patterns.

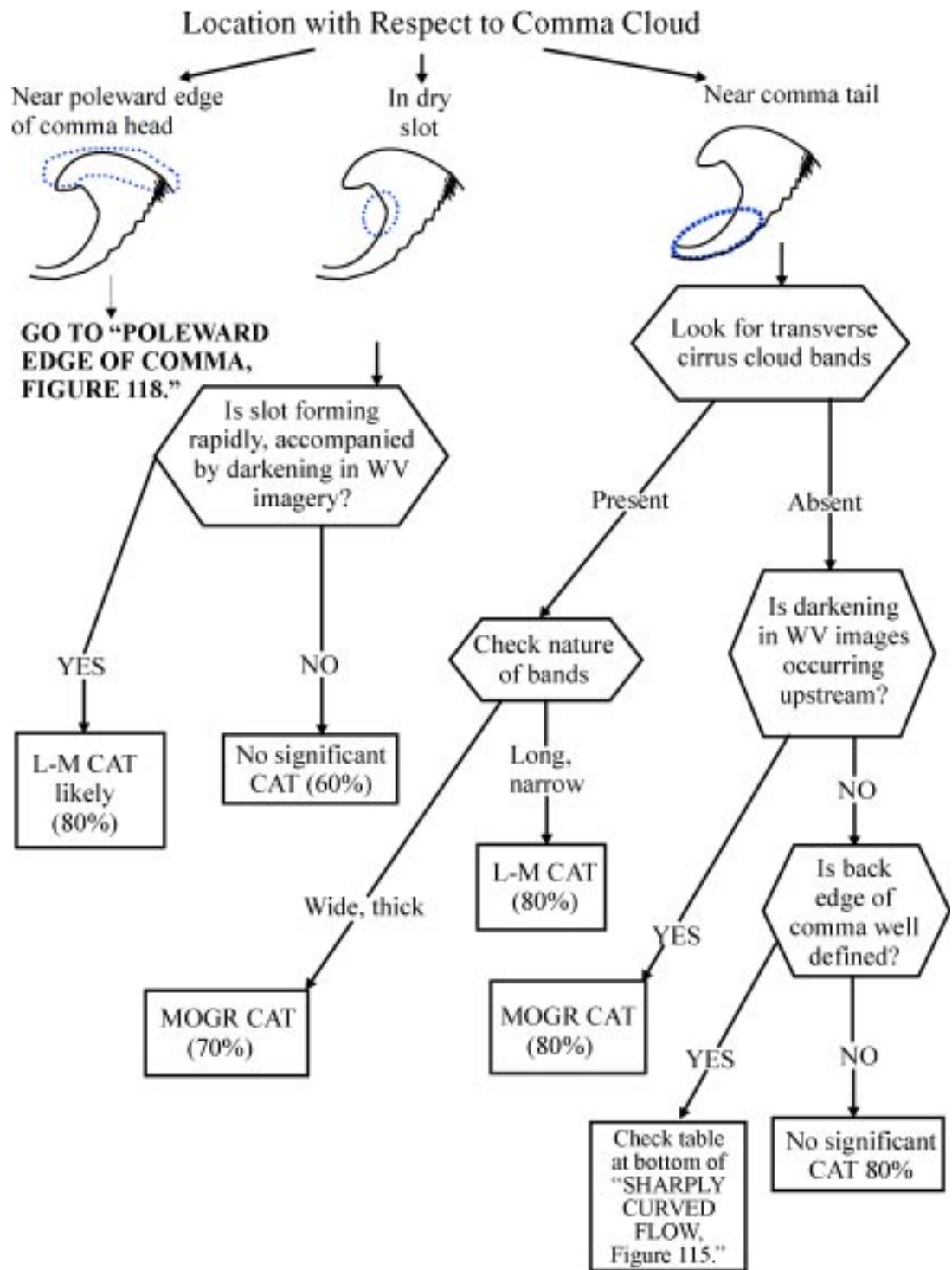

Figure 2-59. CAT Forecasting—with Respect to Comma Cloud.

Poleward Edge of Comma

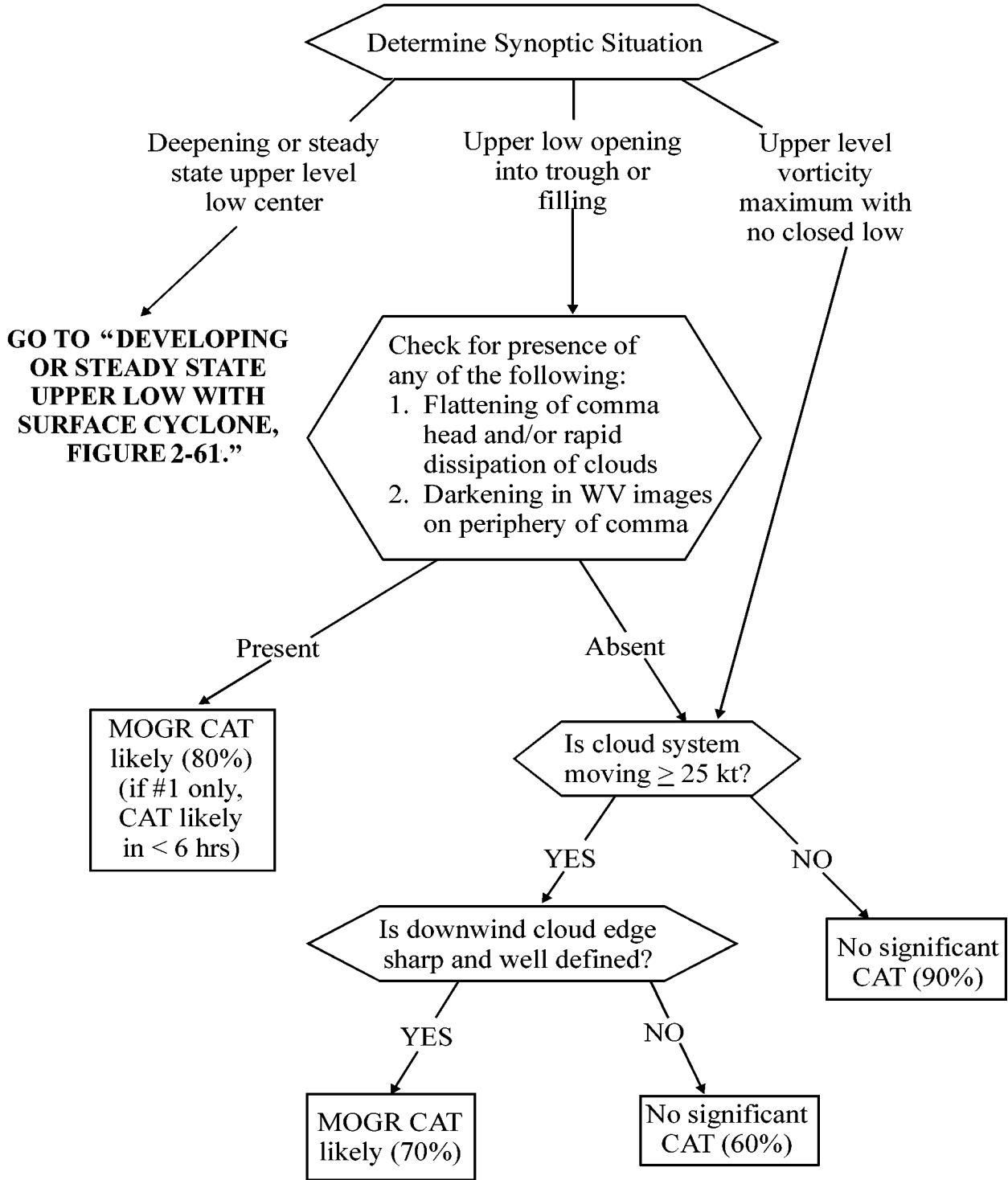

Figure 2-60. CAT Forecasting—Poleward Edge of the Comma Cloud.

Developing or Steady State Upper Low with Surface Cyclone

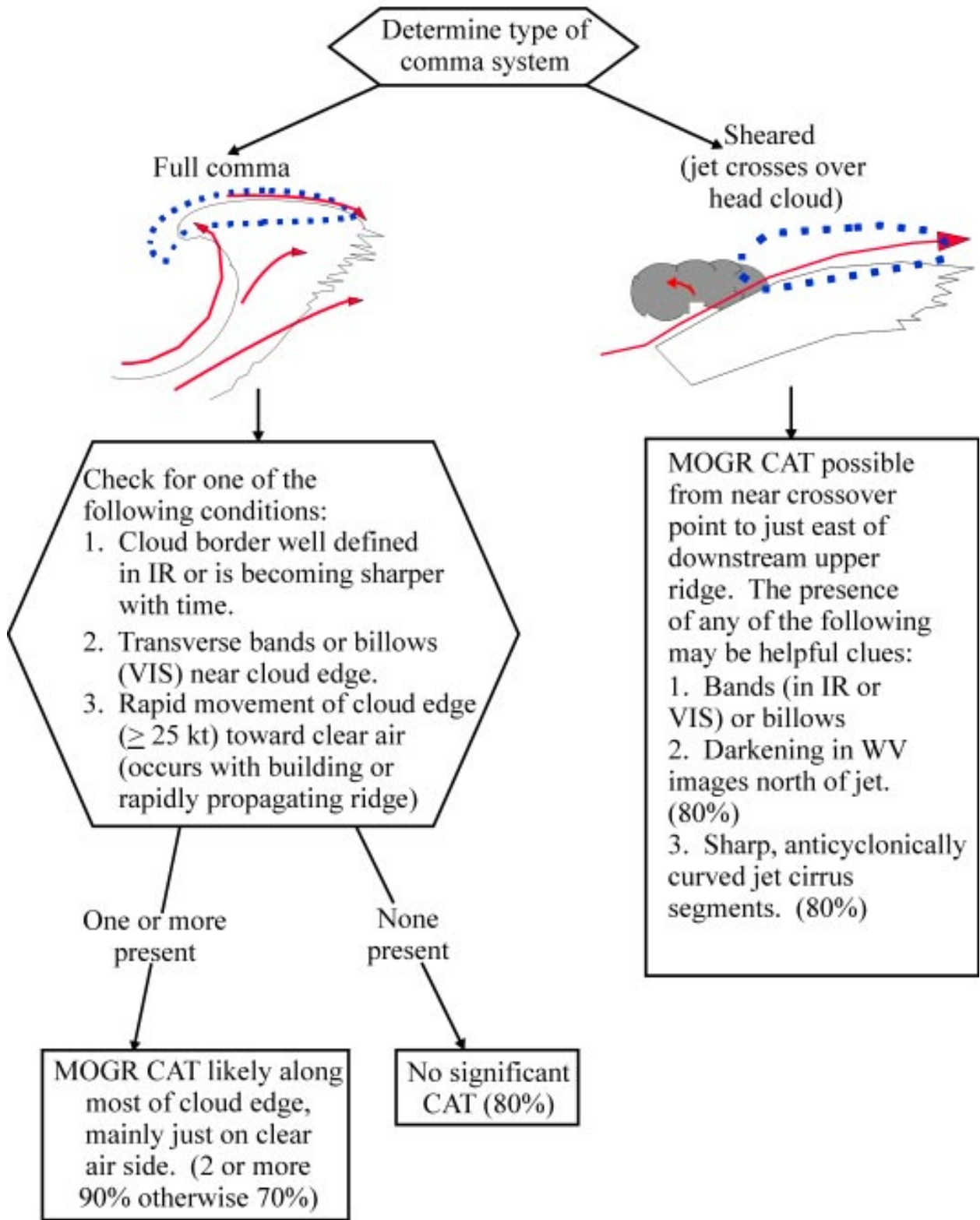

Figure 2-61. CAT Forecasting—Developing or Steady State Upper-Low with Surface Cyclones.

Chapter 2

8. Vertical Cross Sections. Vertical cross-sections of the atmosphere (e.g., Distance-log p diagrams) can greatly increase the understanding of atmospheric structures that contribute to turbulence development. Standard computer software packages can quickly generate and analyze Skew-T data or use gridded fields to generate vertical cross-sections needed for this technique. Isoplething wind speeds (10 knot intervals) and temperature (at 5°C intervals) will reveal jet cores and strong vertical temperature gradients associated with atmospheric turbulence. Frontal boundaries and areas of wind shear that contribute to turbulence can also be found.

9. Doppler Weather Radar. This radar provides unique, near real-time capabilities to detect and display turbulence indicators such as frontal boundaries, low-level jets, gust fronts, and upper-level wind shear.

a. Spectrum Width. Though not conclusive, spectrum width values of 8-11 knots are often associated with moderate turbulence (CAT II aircraft). Values 12 knots or higher may indicate severe turbulence. Use the spectrum width product to confirm suspected turbulence areas found using other products such as base velocity

b. Velocity Azimuth Display (VAD) Wind Profile (VWP). The VWP is a graphic display of winds. This product allows you to examine the current and past vertical wind structure to help identify meteorological conditions associated with atmospheric turbulence evolving over time (e.g., inversions, wind shears, and development of jet streams). Look for areas of sharp turning in the winds with high wind speeds to identify strong local vertical wind shear.

c. Base Velocity. This product displays horizontal wind velocities. Areas of sudden speed or directional shifts are associated with wind shear and atmospheric turbulence. Intense shear regions, such as the top of the thunderstorm associated with storm top divergence, can also be located using base velocity.

d. Vertically Integrated Liquid (VIL). VIL values indicate thunderstorms that may have stronger potential for severe convective weather and associated wind shear and atmospheric turbulence.

III. AIRCRAFT ICING. Structural icing interferes with aircraft control by increasing drag and weight while decreasing lift. Engine-system icing reduces the effective power of aircraft engines. The accuracy of the icing forecast begins with an accurate prediction of precipitation, clouds, and temperature.

Aircraft icing generally occurs between the freezing level and -40°C. However, icing can occur at -42°C in the upper parts of cumulonimbus clouds. The frequency of icing decreases rapidly with decreasing temperatures, becoming rare at temperatures below -30°C. The normal atmospheric vertical temperature profile usually restricts icing to the lower 30,000 feet of the atmosphere.

Icing may occur during any season of the year. In the middle latitudes (such as in most of the United States, Northern Europe, and the Far East), icing is most frequent in winter. Frontal activity is also more frequent in winter, and the resulting cloud systems are more extensive, creating favorable icing conditions. In winter, however, polar regions are normally too cold to contain the concentration of moisture necessary for icing. Generally locations found at higher latitudes (such as Canada and Alaska) have the most severe icing conditions in spring and fall.

A. ICING FORMATION PROCESSES AND CLASSIFICATION.

1. Processes. The initial formation of ice on an aircraft requires the existence of supercooled water droplets in the atmosphere. Aircraft icing then forms by sublimation or by conduction and evaporation after the droplets strike the aircraft. Each of these processes depend on other variables being in place.

a. Supercooled Water Droplets. The supercooled temperature at which droplets start to freeze is known as the spontaneous freezing temperature. The spontaneous freezing temperature of a water droplet can vary from -10° to -42°C. This temperature also varies with droplet size and with the amount and type of foreign particles (freezing nuclei) in suspension. The spontaneous freezing temperature usually decreases with droplet

size, that is, the smaller the droplet size, the lower the temperature that's required before freezing takes place.

b. Sublimation. Sublimation is the transition of a substance from the vapor phase directly to the solid phase, or vice versa, without passing through an intermediate liquid phase. It may occur when an aircraft descends from a cold layer of air into a layer of warm, moist air. Sublimation may also occur at flight level when an aircraft passes from a subfreezing air mass into a moist and slightly warmer air mass. Frost is an example of icing that forms by sublimation.

c. Conduction and Evaporation. These two processes control the formation of ice after the droplet contacts the aircraft. The impact of the droplet on the aircraft causes the temperature of the droplet to rise, which creates a temperature gradient from the droplet to the aircraft. The temperature gradient causes the droplet to cool by evaporation of water vapor between the droplet and the aircraft.

2. Classification.

a. Icing Types. Aircraft structural icing consists of three basic types: clear, rime, and frost. Also, mixtures of clear and rime are common (mixed icing). The type of icing that will form depends primarily upon the temperature and water droplet size (see Figure 2-62).

(1) *Clear Icing.* Glossy, clear or translucent ice formed by the relatively slow freezing of large supercooled droplets. It is potentially the most dangerous type of icing because it adheres so firmly to the aircraft. The droplets spread out over the airframe surface before completely freezing. Since it is transparent, clear icing may initially go undetected.

- Adheres firmly to the exposed surfaces, and is much more difficult to remove with deicing equipment than rime ice.

- Occurs most frequently within stratus clouds at temperatures between -8° and -10°C .

- Forms in cumulus clouds, most commonly at temperatures between 0° and -16°C , but can be encountered in cumulonimbus clouds with temperatures as low as -25°C .

(2) *Rime Icing.* A milky, opaque, and granular deposit with a rough surface. It forms by the rapid freezing of small, supercooled water droplets. This instantaneous freezing traps a large amount of air giving the ice its opaqueness and making it very brittle.

- Forms in cumuliform clouds between -10° and -20°C .

- Can form in stratiform clouds from 0° to -30°C , but occurs most frequently within stratus clouds at temperatures between -8° and -10°C .

(3) *Frost Icing.* Frost is a light, feathery deposit of ice crystals that forms when water vapor contacts a subfreezing surface. Frost can occur on an aircraft in flight, on the ground, and on the upper surfaces of parked aircraft during a clear night with subfreezing temperatures. It also affects the aircraft's lift-to-drag ratio and can be hazardous during takeoff.

(4) *Mixed Icing.* Combination of rime and clear icing. It is formed when water droplets vary in size or when liquid droplets are combined with snow or ice particles. The ice particles become imbedded in the clear icing, building a very rough appearance that can form rapidly on the airframe.

- Most common at temperatures between -10° to -15°C .

- Generally has similar formation requirements as those for rime and clear icing.

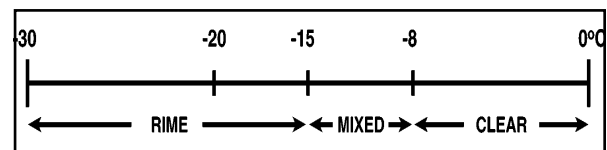

Figure 2-62. Icing Type Based on Temperature. Figure shows temperature ranges for various types of icing.

Chapter 2

b. Icing Intensities.

(1) *Trace.* Icing first becomes perceptible as trace icing. The ice formation rate is slightly greater than the sublimation rate. Trace icing is not usually hazardous to operations unless it persists for longer than 1 hour.

(2) *Light.* Icing condition persist for over 1 hour. Accumulation continues and begins to create a problem for the aircraft. Occasional use of deicing/anti-icing equipment removes/prevents accumulation.

(3) *Moderate.* The rate of accumulation causes even short encounters in the area of icing to be potentially hazardous. Use of deicing/anti-icing equipment is necessary.

(4) *Severe.* The rate of accumulation is so strong that deicing/anti-icing equipment fails to reduce or control the hazard. Immediate diversion is necessary.

B. VARIABLES FOR DETERMINING ICING ACCUMULATION.

1. Airspeed. The rate of ice formation increases with the airspeed of the aircraft. However, at very high speeds, friction creates enough heat on the skin of the aircraft to melt structural ice. Icing is seldom a problem at airspeeds in excess of 575 knots. Helicopter rotor speeds of 570 to 575 knots preclude ice buildup on the outboard portion of the main rotor blades. The chance of ice buildup on the rotor, however, increases inboard toward the rotor disk.

2. Droplet Size. The rate of ice formation will increase with an increase in droplet size. When aircraft pass through clouds or precipitation, small water droplets tend to move with the deflected air stream, and not collect on the aircraft wing or structural parts. Larger supercooled droplets can resist the deflecting influence and strike aircraft surfaces causing ice to form. Ice formation is more

rapid in cloud formations that are thick and continuous, due to the large quantities of supercooled liquid water.

3. Aircraft Size and Shape. The rate of ice formation varies with the size, shape, and smoothness of aircraft surfaces and airfoils. Ice accumulates faster on large non-streamlined aircraft with rough surface features than it does on thin, smooth, highly streamlined aircraft. However, once ice forms, the rate of ice formation accelerates since the accumulated ice presents a larger surface area upon which droplets can freeze and collect.

C. METEOROLOGICAL CONSIDERATIONS.

1. Cloud Type. The type and amount of icing varies with each type of cloud.

a. Stratiform. Stable air masses often produce stratiform clouds with extensive areas of relatively continuous potential icing conditions. Icing intensities in-cloud generally range from light to moderate, with the maximum intensity occurring in the cloud's upper portions. Both rime and mixed icing may be observed in stratiform clouds. High-level stratiform clouds (e.g., cirrostratus) contain mostly ice crystals and produce little icing.

- Typically occurs in mid- and low-level clouds in a layer between 3,000 and 4,000 feet thick.

- Rarely occurs more than 5,000 feet above the freezing level (normal atmospheric conditions).

- Multiple layers of clouds may be so close together that flying between layers is impossible. In these cases, maximum depth of continuous icing conditions rarely exceeds 6,000 feet.

b. Cumuliform. Unstable air masses generally produce cumuliform clouds with a limited horizontal extent of potential icing conditions. Icing generally occurs in the updraft regions in a mature cumulonimbus and is confined to a shallow layer near the freezing level in a dissipating thunderstorm (see Figure 2-63).

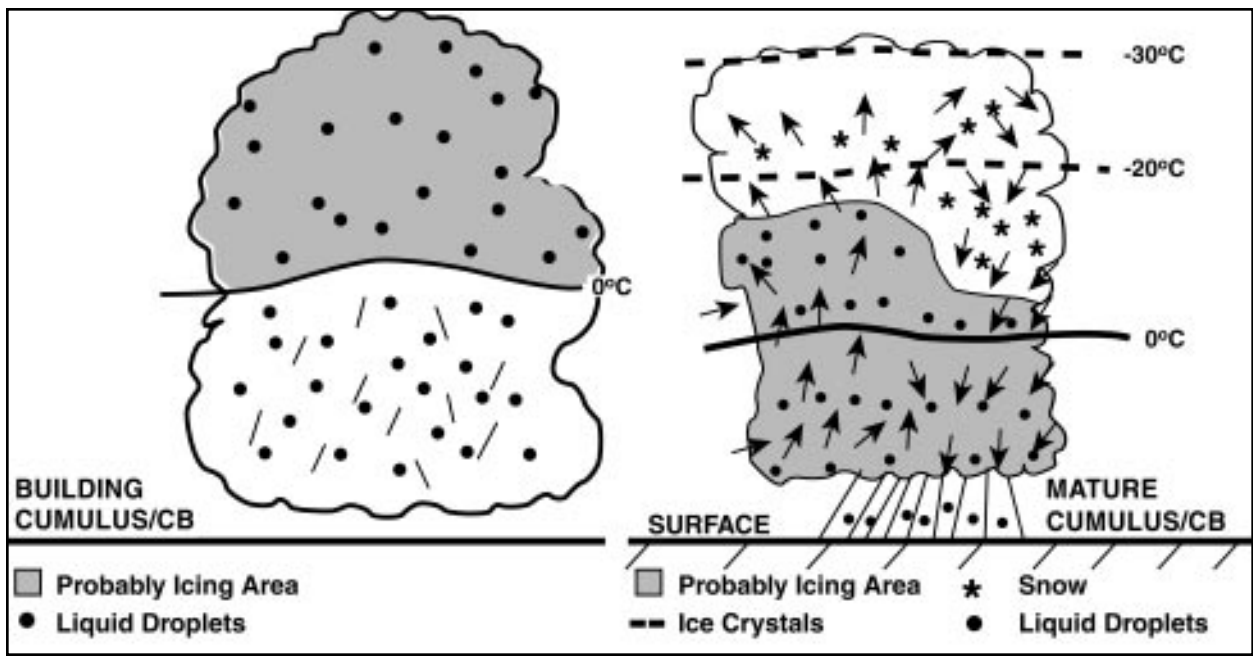

Figure 2-63. Cumuliform Cloud Icing Locations. The figure shows the location of icing in the building and mature stages of cumuliform cloud formation and dissipation.

Icing intensities generally range from light in small cumulus below freezing to moderate or severe in towering cumulus and cumulonimbus. The most severe icing occurs in convective clouds just prior to beginning the cumulonimbus stage. Although icing occurs at all levels above the freezing level in building cumulus, it is most intense in the upper-half of the cloud.

- The zone of icing in cumuliform clouds is smaller horizontally but greater vertically than in stratiform clouds.

- Icing (usually clear or mixed) is more variable in cumuliform clouds because many of the factors conducive to icing depend largely on the particular stage of the cloud's development.

c. Cirriform Clouds. Icing rarely occurs in cirrus clouds, even though some non-convective cirriform clouds do contain a small proportion of water droplets. However, moderate icing can occur in the dense cirrus and anvil tops of cumulonimbus, where updrafts may contain considerable amounts of supercooled water.

2. Frontal Systems. Icing can occur either above or below frontal surfaces aloft. The following general rules will help in forecasting frontal icing.

a. Above the Frontal Surface Aloft. For significant icing to occur above a frontal surface, lifted air must cool to temperatures below freezing, and be at or near saturation. Icing may occur over either a warm frontal or a shallow cold frontal surface. While precipitation forms in the relatively warm air above the frontal surface at temperatures above freezing, icing usually occurs in regions where cloud temperatures are colder than 0°C. Generally, this layer is less than 3,000 feet thick. If the warm air is unstable, icing occurrence may be sporadic; if the air is stable, icing may be continuous over an extended area.

b. Below the Upper Frontal Surface Aloft. Occurs most often as freezing rain or drizzle. As it falls into the cold air below the front, the precipitation becomes supercooled and freezes on impact with aircraft. Freezing drizzle and rain occur with both warm fronts and shallow cold fronts.

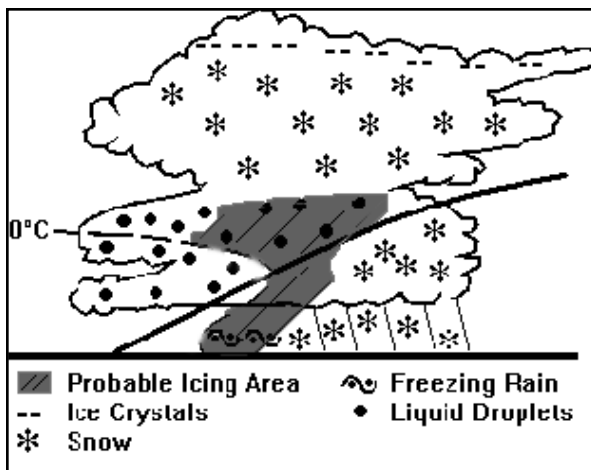

Figure 2-64. Icing with a Warm Front. Icing occurs up to 300 miles ahead of the warm frontal surface position.

c. Frontal Icing Characteristics.

(1) Warm Fronts (Figure 2-64).

- Clear or Mixed Icing. Occurs 100 to 200 miles ahead of the warm frontal surface position.
- Light Rime Icing. Normally occurs in altostratus up to 300 miles ahead of the warm frontal surface position.

(2) Cold Fronts. Icing associated with cold fronts is usually not as widespread as that with warm fronts because cold fronts typically move faster and have fewer clouds (Figure 2-65).

- Clear Icing. More prevalent than rime icing in the cumuliform clouds associated with cold fronts.
- Moderate Icing. Light-moderate clear icing occurs in supercooled cumuliform clouds up to 100 miles behind the cold front surface position. It occurs most readily above the frontal zone.
- Light Icing. Occurs in the extensive layers of supercooled stratocumulus clouds that frequently exist behind cold fronts. Icing in the stratiform clouds of a widespread slow moving cold frontal cloud shield is similar to icing associated with warm fronts.

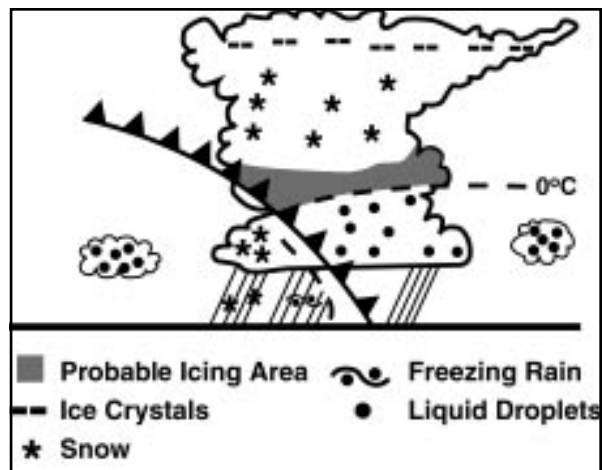

Figure 2-65. Icing with a Cold Front. Icing associated with cold fronts is usually not as widespread as icing with warm fronts.

(3) Stationary and Occluded Fronts. Icing associated with occluded and stationary fronts are similar to that of warm or cold frontal icing, depending on which type the front most resembles. Moderate icing frequently occurs also with deep, cold, low-pressure areas where frontal systems are indistinct.

Note: Icing can be severe in freezing precipitation.

3. Other Icing Conditions.

a. Terrain. Icing is more likely and more severe in clouds located over mountainous regions than over other terrain. Strong upslope flow can lift large water droplets as much as 5,000 feet into subfreezing layers above a peak, resulting in supercooled water droplets. In addition, when a frontal system moves across a mountain range, the normal frontal lift is enhanced by the mountain's upslope effect to create extremely hazardous icing zones.

b. Induction Icing. In addition to the hazards created by structural icing, an aircraft frequently is subjected to icing of the power plant itself. Ice develops on air intakes under the same conditions favorable for structural icing. Ice formation is most common in the air induction system but may also be found in the fuel system. The main effect of induction icing is power loss due to its blocking of the air before it enters the engine. On some

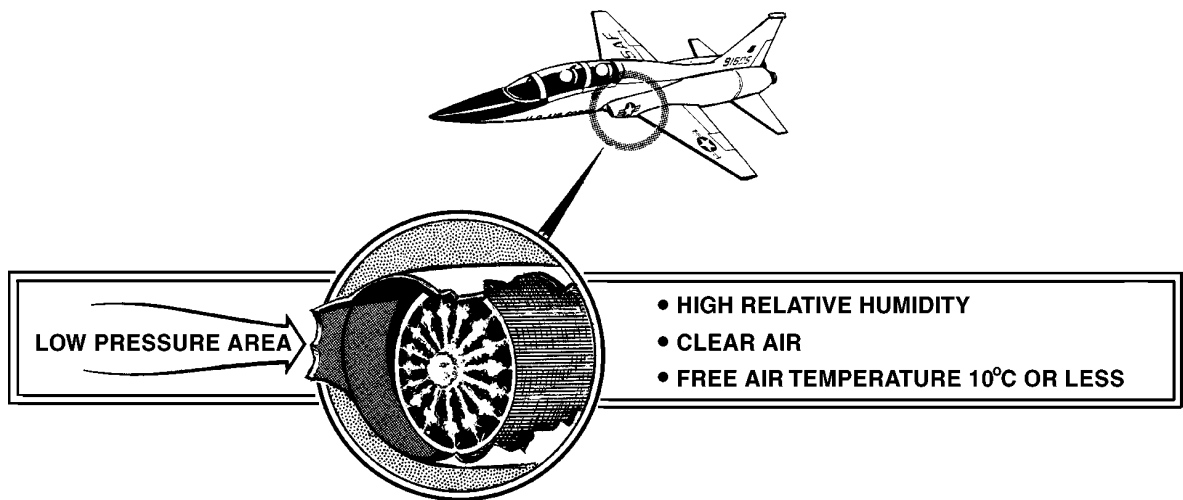

Figure 2-66. Intake Icing. Ice formed on these surfaces can later break free, causing potential foreign object damage to internal engine components.

helicopters, a loss of manifold pressure concurrently with air intake screen icing may force the immediate landing of the aircraft.

(1) *Air Intake Ducts.* In flights through clouds containing supercooled water droplets, air intake duct icing is similar to wing icing. However, the ducts may ice when the skies are clear and the temperatures are above freezing. During taxi, takeoff, and climb, reduced pressure exists in the intake system (see Figure 2-66). This lowers temperatures to the point that condensation and/or sublimation takes place, resulting in ice formation which decreases the radius of the duct opening and limits the air intake. Ice formed on these surfaces can later break free, causing potential foreign object damage to internal engine components.

(2) *Carburetor Icing.* Carburetor icing is treacherous, and frequently causes complete engine failure. It may form under conditions in which structural ice could not possibly form. Carburetor icing occurs when moist air, drawn into the carburetor, is cooled to a dew point temperature less than 0°C (frost point). Ice in the carburetor may partially or totally block the flow of the air/fuel mixture as seen in Figure 2-67.

- When the relative humidity of the outside air being drawn into the carburetor is high, ice can form inside the carburetor (even in cloudless skies) when the temperature is as high as 22°C (72°F) or as low as -10°C (14°F).

- The fact that carburetor icing can occur in temperatures well above 0°C, may lead the pilot to potentially misdiagnose engine problems.

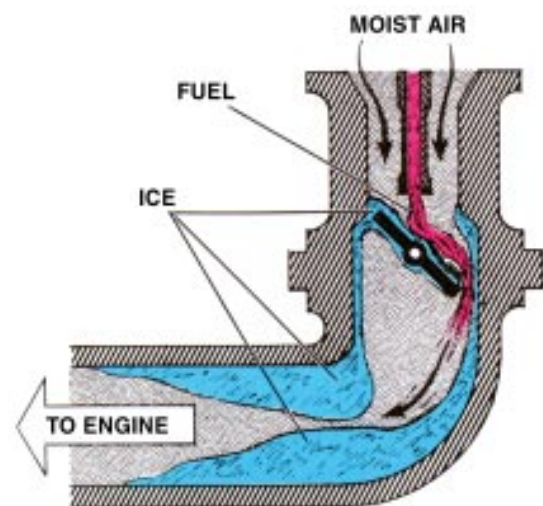

Figure 2-67. Carburetor Icing.

Chapter 2

D. PRODUCTS AND PROCEDURES. Below is a listing of products and what to look for during the evaluation process of determining icing conditions. Later paragraphs will provide some rules of thumb and methods/procedures that expand on some of the products listed here.

1. Centralized Products.

a. AFWA High-Level and Low-Level Hazard Charts. Extrapolate and adjust AFWA-produced icing products. Use them to decide if favorable icing conditions exist.

b. Military Weather Advisories (MWA). Use the military weather advisory, MWA, to check for freezing precipitation along the route that could suggest moderate (freezing drizzle) or severe (freezing rain) icing.

c. AIRMETs and SIGMETs. These provide information on moderate and greater areas of icing.

2. Upper-Air Reports, Data, and Products.

a. PIREPs and AIREPs. Use these reports to verify icing forecasts, to locate icing areas which impact your area of responsibility, and to identify synoptic conditions causing icing.

Note: PIREPs/AIREPs are important data sources since they originate from aircrews—those most threatened by icing conditions. Therefore, solicit aircrews aggressively for reports so other aircrews may benefit from their reporting.

Table 2-14. Unfavorable Atmospheric Conditions for Icing.

Temperature	Dew Point Depression	Forecast
0°C to -7°C	> 2°C	None
-8°C to -15°C	> 3°C	None
-16°C to -22°C	> 4°C	None
Lower than -22°C	Any Spread	None

b. Upper-Air Data. Check upper-air soundings along a flight route for dew-point spreads at flight level, then use Tables 2-14 and 2-15 to determine icing. Also, analyze the upper-level flow to identify upstream icing which may advect into the route of flight by the time the aircraft reaches the area.

c. Upper-Air Composites on AWDS. Upward vertical motion in the vicinity of a jet stream maximum, combined with adequate moisture and cold-air advection, give a good indication of icing. When these upper-air composite features are located together in a common area, generally forecast icing. Use other information in this section to determine icing type and intensity.

(1) **Vorticity.** Use the 500-mb product to show areas of positive and negative vorticity advection (PVA/NVA). Overlay the Omega Vertical Velocity product (OVV) to show vertical motion.

(2) **Wind Speed (Jet Stream).** Use 300- and 200-mb data to identify the location of jet streams, with emphasis on wind speed maxima and minima.

Table 2-15. Favorable atmospheric conditions for icing.

Temperature	Dew Point Depression	Advection	Forecast	Probability
0°C to -7°C	$\leq 2^\circ\text{C}$	Neutral/Weak Cold-air	Trace	75%
		Strong Cold-air	Light	80%
-8 to -15°C	$\leq 3^\circ\text{C}$	Neutral/Weak Cold-air	Trace	75%
		Strong Cold-air	Light	80%
0°C to -7°C	$< 2^\circ\text{C}$	None	Light	90%
-8 to -15°C	$\leq 3^\circ\text{C}$	Associated areas with vigorous cumulus buildups due to surface heating		

(3) *Moisture.* Analyze the 850-, 700-, and 500-mb analysis products for moisture. Sufficient moisture, combined with cold-air advection, should alert the forecaster to the possibility of icing in that area.

(4) *Thermal Advection Patterns.* Evaluate the 1000-500 mb, 1000-700 mb, or 1000-850 mb thickness products for thermal advection patterns. Cold-air advection into an area often increases the possibility of icing.

d. Other Composites.

(1) *Icing from Freezing Precipitation.* The following are instructions for creating a composite product using surface and 850-mb data.

Step 1. Isopleth surface isotherms in one color and then overlay the 850-mb isotherms in another color.

Step 2. Display the 850-mb moisture (dew-point depression of 2°, 3°, 4°C) using a third color.

Step 3. Look for areas on the composite chart with surface temperatures of 0°C or colder and 850-mb temperatures above freezing. Precipitation in these areas (dew-point depressions of 4°C or less) is likely to be occurring as freezing rain or freezing drizzle.

(2) *Horizontal Weather Depiction (HWD).* Freezing level forecast products overlaid on an HWD product can be a useful tool for identifying areas and levels of icing.

e. Vertical Cross Section. Generate a vertical cross section to show the amount of moisture in the

atmosphere and the associated temperatures and dew-point depressions at the levels of interest. Evaluate the cross section to see where the following rules of thumb might apply.

(1) *Relative Humidity (RH).* Identifying relative humidity values in an area can also be a key to making an accurate icing forecast. Generally, values greater than 65 percent indicate broad areas of icing.

(2) *Temperature and Dew-Point Depression – Icing Occurrence.* Knowing the relationship between temperature and dew point in the atmosphere can provide a good indication of the occurrence of icing. Some rules of thumb below include the percent probability (i.e., 80 percent) of icing for the described conditions. Use Figures 2-62, 2-63, and 2-68. Also refer to Tables 2-14 and 2-15.

(3) *Temperatures – Icing Types.* Temperatures can also indicate the type of icing to forecast. Clear ice usually occurs at temperatures just below freezing, whereas rime ice predominates at lower temperatures. Use the rules of thumb below as a general guide for forecasting icing types.

- Forecast rime icing when temperatures at flight altitude are colder than -15°C or when between -1° and -15°C in stable stratiform clouds.
- Forecast clear icing when temperatures are between 0° and -8°C in cumuliform clouds or in freezing precipitation.
- Forecast mixed rime-and-clear icing when temperatures are between -8° and -15°C in unstable clouds.

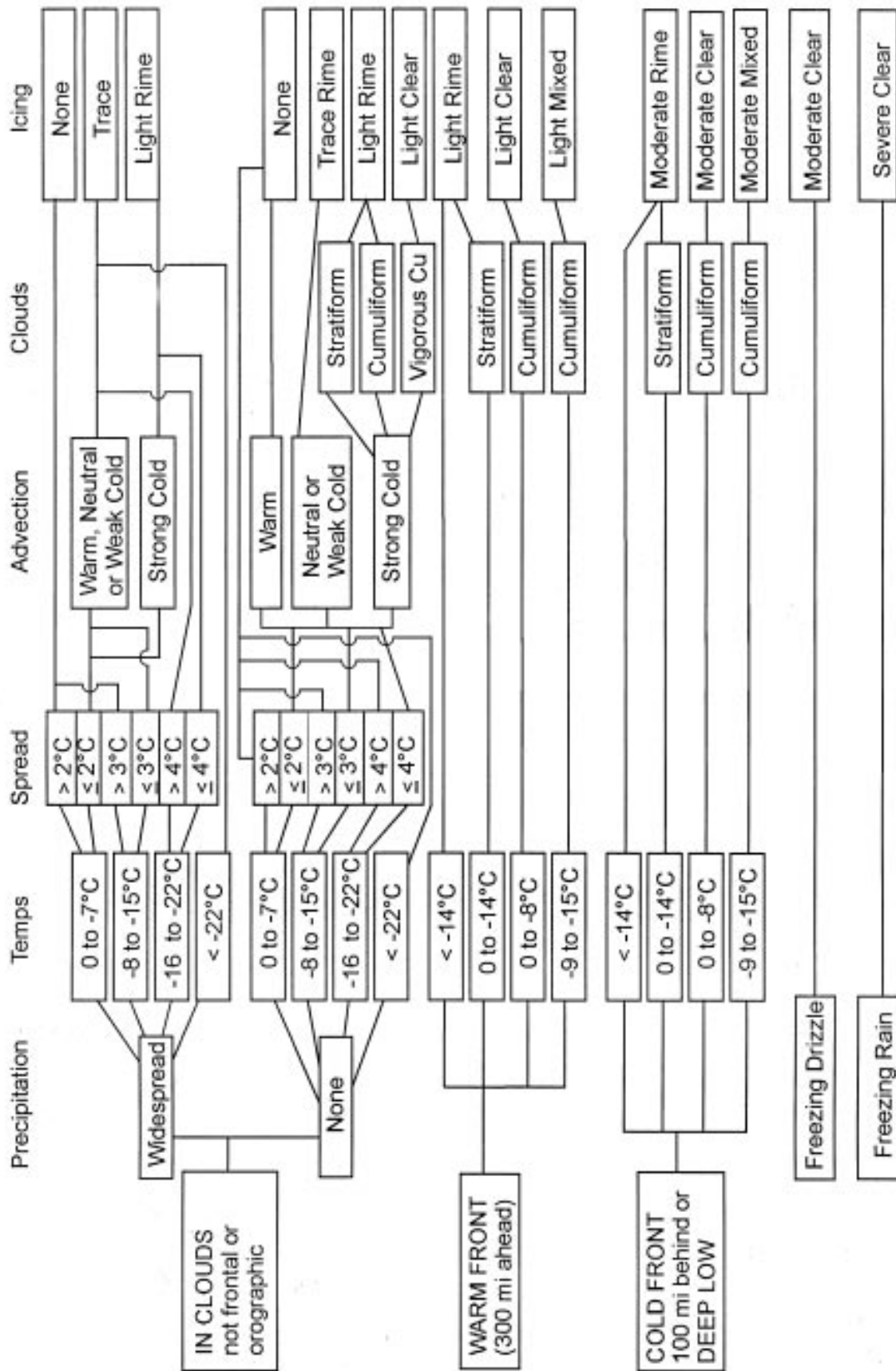

Figure 2-68. Icing Flowchart.

f. Surface Products. Surface products can be used as a guide for potential icing conditions. This is not as reliable as using an upper-air analysis, but it can be very useful. Possible icing occurs along frontal cloud shields, low-pressure centers, and precipitation areas along the route (see Figure 2-69). General locations for icing, in relation to the position of surface features are:

- Up to 300 miles in advance of a warm front.
- Up to 100 miles behind the cold front .
- Over a deep, almost vertical low center.

E. STANDARD SYSTEM APPLICATIONS.

1. Radar. Use the WSR-88D, Doppler Weather Radar, to determine potential icing areas using reflectivity and velocity products. The following rules of thumb will help to identify icing conditions with the WSR-88D.

a. Cold Air Advection (CAA). Base Velocity (V) and the VAD Wind Profile (VWP) are helpful products for determining CAA. The Base Velocity Product indicates cold-air advection by a backward S-shaped pattern in the zero isotach. The VWP will show winds backing with height, associated with cold-air advection (the same pattern you see on the

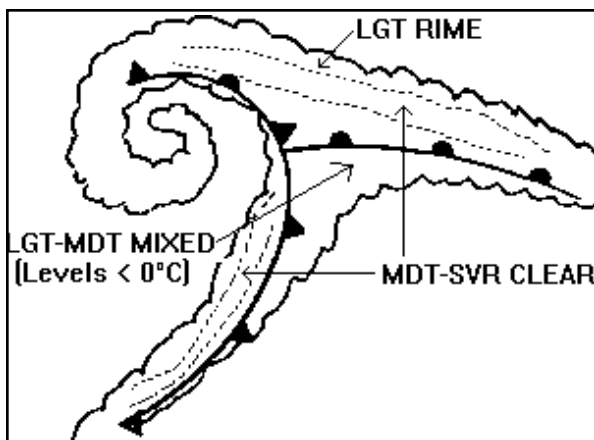

Figure 2-69. Typical Icing Areas in a Mature Cyclone. The figure shows general locations for icing, in relation to the position of surface features.

Skew-T). Updated every volume scan, the VWP is also a valuable tool to monitor changes in the vertical profile between upper-air runs and should always be used to augment your Skew-T.

b. Freezing Level. The Reflectivity Cross Section (RCS) can also be used to identify and measure the height of the freezing level. To obtain an accurate measurement of the height of the freezing level, choose RCS end points on different sides of the bright band on the Base Reflectivity product.

c. Bright Band Identification. The Base Reflectivity product will display the freezing level as a ring of enhanced reflectivity (30 to 45 dBZ) around the Radar Data Acquisition Unit (RDA). This enhanced area is called the bright band, formed when frozen precipitation melt as it falls through the freezing level (Figure 2-70.). The height of the outer edge of the bright band is the height of the freezing level (0°C). You can measure height MSL by placing the cursor on the area of interest and reading the elevation to the right of the reflectivity panel.

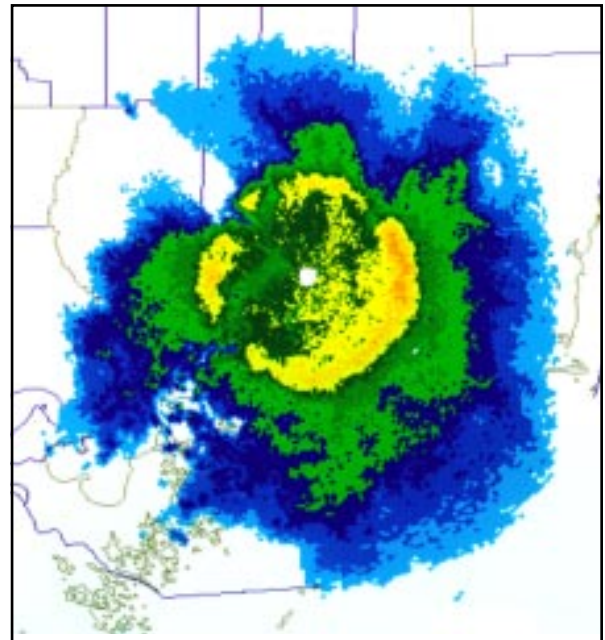

Figure 2-70. Bright Band Identification Using the WSR-88D. The enhanced area is called the bright band, formed when frozen precipitation melt as it falls through the freezing level.

Chapter 2

d. Moisture. The Base Reflectivity displays cloud droplets (primarily in clear air mode) and precipitation. At temperatures between 0° and -22°C, if the base reflectivity product indicates clouds, supercooled water may be present and this moisture may cause icing.

2. Satellite Imagery.

a. GOES-8 and GOES-9 Imagery. There are five spectral channels on GOES-8 and GOES-9; three of them (Channels 1, 2, and 4) can be useful in spotting potential aircraft icing areas.

(1) *Channel 1 (Visible).* Brighter clouds on visible imagery imply greater thickness and high water content. Visible data can also assist in the identification of embedded convection.

(2) *Channel 2 (Near Infrared).* Three principles of radiation apply to using this channel. First, small water droplets are more reflective than larger ones. Second, water clouds are more reflective than ice clouds. Finally, warm scenes radiate more than cold scenes.

- Thus, during the daytime, ice clouds (relatively large particles, poorly reflective, and cold) will be darker than small droplet water clouds (smaller droplets, higher reflectivity, and warmer).

- Supercooled clouds, composed of small water droplets, may be very cold (down to -20°C), but they appear brighter during the daytime due to reflected radiation.

(3) *Channel 4 (Infrared or IR).* Cloud-top temperatures can be obtained from IR imagery. If the cloud-top temperature is in the range 0° to -20°C, icing may be present. However, if cloud tops are close to 0°C, the in-cloud temperature may be above freezing and no icing will occur.

(4) *Channel Comparisons.* Compare Channels 1, 2, and 4 to find supercooled clouds during daytime hours. Embedded lighter gray shades sometimes occur with heavier icing due to the large cloud droplet sizes (higher liquid water content) or slightly thicker clouds.

b. GMS and Meteosat. These provide basic Visible and IR images only. Image enhancement (such as those available from GOES satellites) is not available. Use rules applying to GOES channels 1-4 above to detect possible areas of icing.

F. METHODS AND RULES OF THUMB FOR THE “NEGATIVE 8 TIMES D” (-8D) PROCEDURE. One effective way to forecast icing is by using the Skew-T to complete the -8D Method. An example of the completed method can be found in Figure 2-71.

1. -8D Method; Procedures.

Step 1. Plot the upper-air data from a sounding on a Skew-T.

Step 2. Plot the temperature and dew point in degrees and tenths to the left of each plotted point.

Step 3. Determine the dew-point depression for the significant levels. This is D and is always positive or zero.

Step 4. Multiply the dew-point depression (D) by -8 and plot the product (in °C) opposite the temperature at the pressure level.

Step 5. Repeat Step 4 for each temperature between 0°C and -22°C.

Step 6. Connect the points plotted by step 5 with a dashed line.

Step 7. Icing layers usually occur between the intersection of the temperature curve and the -8D curve when it is to the right of the temperature curve. These are levels which are supersaturated with respect to ice.

Step 8. Use the cloud type, the precipitation observed at the sounding time or forecast time, as well as the temperature and dew point to forecast the type and intensity of icing.

Note: In this example, the air in the middle layers is supersaturated with respect to ice. Forecast icing

in this layer using Figure 2-71 and the information that follows to determine type and intensity.

2. -8D Method; Rules of Thumb.

- When the temperature curve lies to the right of the -8D curve in a subfreezing layer, the layer is subsaturated with respect to both ice and water surface. Icing does not usually occur in this region.

- When the dew-point depression is 0°C , the -8D curve must fall along the 0°C isotherm. In the subfreezing layers, light rime icing will likely occur in altostratus or nimbostratus, with moderate rime icing occurring in cumulonimbus, cumulus, and stratus cloud types.

- When the dew-point depression is greater than 0°C and the temperature curve lies to the left of the -8D curve in the subfreezing layer, the layer is supersaturated with respect to ice and probably subsaturated with respect to cloud droplets.

- If altostratus, altocumulus, or stratocumulus is expected in this layer, usually only light rime icing occurs.

- If the clouds are cirrus, cirrocumulus, or cirrostratus, usually only light frost sublimates on aircraft.

- In cloudless regions, there will be no supercooled droplets, but frost will often form on the aircraft through direct sublimation of water vapor. This is a factor to aircraft and helicopters that cannot tolerate any form of icing.

G. SUMMARY. Some aircraft have limited or no deicing capability and therefore must avoid icing conditions at all times. Icing forecasting begins with a solid understanding of the physical processes responsible for icing and a thorough knowledge of the atmospheric conditions over your area of responsibility.

If icing is suspected, start with the general rules provided (tailored with local rules of thumb and techniques) and interrogate the atmosphere for location, type, and severity of icing. When icing is probable, use the techniques and tools presented to further refine your forecast.

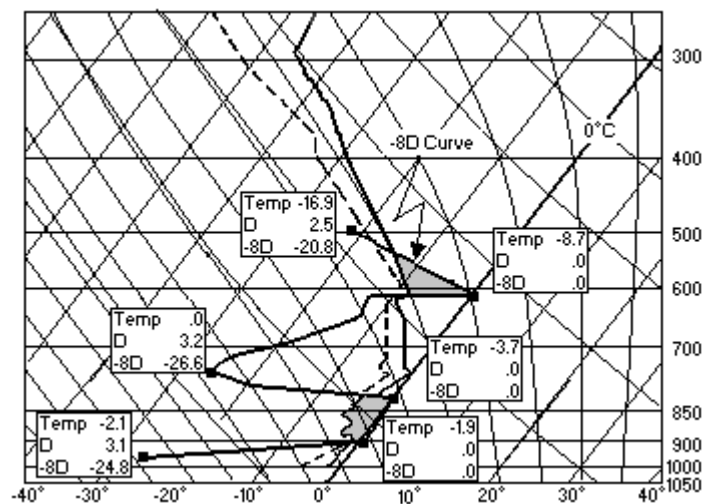

Figure 2-71. Example of -8D Method. The figure is a graphical presentation of the -8D method for forecasting icing.

IV. MISCELLANEOUS WEATHER ELEMENTS. This section focuses on flight weather elements (wind, temperature, thunderstorms, contrails, and D-values) that do not fit neatly into other sections. Some of these areas receive more in-depth explanations in other parts of this publication (i.e., thunderstorms in the Severe Weather Section), but they're addressed here to show how they are tied into forecasting flight weather elements.

A. FLIGHT LEVEL AND CLIMB WINDS.

1. Flight Level Winds. Forecasting accurate flight level winds (winds aloft) helps aircrews plan efficient fuel requirements and result in safer and more timely missions. Flight weather briefers use a variety of tools and products in preparing to forecast flight level winds. In most cases, use the following tools and products without modification; however, spot check them against other information and adjust, if necessary, when other information is available.

a. Constant Pressure Products. These rules of thumb should be used when determining flight level winds from constant pressure products:

- Use the product nearest to the desired level and extrapolate upward or downward as necessary.
- Relationships between isotherm and height contours are invaluable in forecasting upper winds. If the wind direction is known, estimate the speed through the following relationship between isotherms and contours.

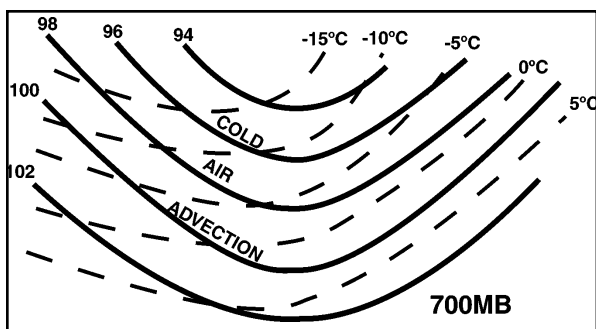

Figure 2-72. Increasing Wind Speed Pattern. Tight thermal packing associated with cold-air advection indicates increasing wind speeds.

•• Little change in wind speed and direction results when isotherms and contours are in phase and parallel.

•• Increasing flight level winds occur with tight thermal gradients (denser packing of isotherms) associated with cold-air advection aloft (See Figure 2-72).

•• Decreasing flight level wind speeds occur with loose thermal gradients (looser packing of isotherms) associated with warm-air advection aloft (See Figure 2-73).

b. Satellite Imagery. Interpret wind directions and speeds using cloud shape, size, and orientation.

c. Vertical Cross Section—Distance Log-P Plots. Distance Log-P plots and contours can provide a general picture of wind speeds along a cross section. Keep in mind that wind speeds are approximate values since they're interpolated between the actual station data points.

Note: This product is best used to locate synoptic features such as jet streams, jet cores, and wind patterns.

2. Climb Winds. Forecast climb winds using upper-level wind and temperature products displayed from standard meteorological systems, or by using rawinsonde data plotted by local computer programs. Below are specific examples of resources available to forecast climb winds:

a. Upper-Air Products. Locate the area of interest and read the winds directly from several

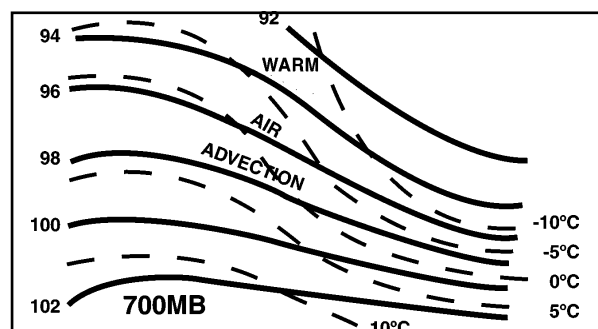

Figure 2-73. Decreasing Wind Speed Pattern. Loose thermal packing associated with warm-air advection indicates decreasing wind speeds.

upper-air charts. Interpolate intermediate winds and temperature (2°C or 5.5°F/1,000 feet). Winds and temperatures interpolated from these charts will not be as accurate as those interpreted from the winds from a Skew-T.

b. Time Cross Section—Time Log-P Winds.

Cross section plots and associated contours can provide a good look at a vertical cross section of the current, plus 3 previous, model runs for a specific station. Use this product to review wind trends at or near your station or to investigate wind behavior at another station during a specific weather event. Extrapolate the information on these plots to produce a fairly accurate short-range wind forecast.

c. Vertical Azimuth Display (VAD) Wind Profile (VWP). The VWP display on the Doppler radar provides representative wind direction and speed measurements compiled at several heights and distances from the radar antenna. The VAD default range is 16 nm from the antenna. Up to 11 previous profiles (one profile per volume scan) can be displayed on screen, with the most recent profile to the far right. The VWP displays wind direction and speed values in 1,000 foot increments, adjustable up to 70,000 feet MSL. Because of its usefulness, each station should include the VWP as part of the Routine Product Set (RPS) lists.

Not all volume scans will produce a usable VWP product. If “ND” appears instead of a wind direction and speed, the winds could not be determined at that level due to a lack of scatterers or the thresholds for RMS and symmetry were exceeded. However, you may still be able to find valuable wind information by examining the VAD wind product for the levels of interest. Keep the following in mind when using VWPs:

- Precipitation creates a high concentration of scatterers; therefore, VWPs usually give good wind estimates in these conditions.
- The amount of scatterers available in the radar beam affects the radar’s ability to make good wind estimations.
- Scatterers are often scarce in clear, cold air; therefore, VWP may not be reliable in such

conditions. In some cases, the radar may produce no wind information at all.

- High Root Mean Square (RMS) values do not always mean the wind data is incorrect. Compare a high RMS wind with values at heights immediately above and below (vertical and time consistency) to assess its accuracy. The wind display shows RMS values in knots using color-coded wind barbs in five different ranges.

d. Upper-Air Soundings. Locate sounding data nearest to the area of interest and read the winds and temperature directly from the standard and supplemental levels. These soundings are used to plot the Skew-T, so they give representative winds and temperatures within about an hour of the time of the sounding run.

e. Skew-T, Log P Diagram. Read winds and temperatures directly from the plot. Heights are given in kilometers (km) or thousands of feet using a scale on the far right. Keep in mind that Skew-Ts do not present an instantaneous profile of the winds directly above the radiosonde site.

Note: Radiosonde balloons ascend at a rate of about 1,000 feet a minute. In 1-hr of ascent time, the balloon is carried downwind approximately 20 to 100 NM and to an altitude of as high as 60,000 feet by the prevailing upper-level winds.

B. TEMPERATURE. Use centrally produced forecast products to forecast temperatures aloft. If the temperature is in a layer between standard levels, interpolate between the base and the top of the layer. If you know only one boundary temperature, then extrapolate using an assumed lapse rate of 2°C (5.5°F) per 1,000 feet in the troposphere, and isothermal conditions in the stratosphere up to 100,000 feet.

C. THUNDERSTORMS. Forecast thunderstorms for high-level flights the same as you do for low-level operations, with one main difference—do not underestimate thunderstorm tops. Pilots are usually able to better detect individual thunderstorms at high altitudes than at low altitudes when they are not imbedded in cirrus clouds. However, they may not

Chapter 2

be able to fly over them due to limitations in their aircraft's maximum ceiling. Use the following tools to find thunderstorm tops:

- Look at the latest MWA, FANH, FATR, or local hazardous weather products.
- Checkout the latest composite radar products, convective SIGMETs and/or PIREPs.
- Use radar for local thunderstorm tops, or dial-up other RDAs for thunderstorm tops in other areas.
- Use a sequence of infrared (IR) satellite images, with Skew-T data, to get the temperature and height of the coldest convective cloud tops.

D. CONTRAILS. Condensation trails are elongated tubular-shaped clouds composed of water droplets or ice crystals that form behind an aircraft when the wake becomes supersaturated with respect to water or ice. They can signal the presence and the location of the aircraft, which in time of war can be a real danger.

1. Contrail Types:

a. Engine Exhaust Induced. This is the most common form of contrails and also the most visible. They form when water vapor within exhaust gasses mix with and saturate the air in the wake of a jet aircraft. Whether or not the wake reaches saturation depends on the ratio of water vapor to heat in the exhaust gas as well as on the pressure, temperature, and relative humidity of the surrounding environment.

b. Aerodynamically Induced. Aerodynamic contrails form by the momentary reduction of air pressure as air flows at high speeds past an airfoil. These trails usually form at the tips of the wings and propellers. They are relatively rare and occur for only short periods in an atmosphere that is nearly saturated. Aerodynamic contrails occur during extreme flight maneuvers in saturated air and are virtually impossible to forecast. A small change in

altitude or reduction in airspeed, however, is usually enough to stop formation.

c. Instability Induced. Even though it is a rare occurrence, aircraft flying through an undisturbed layer of moist, unstable air can create instability contrails.

2. Forecasting Probability of Contrail Formation. Critical relationships between pressure, temperature and relative humidity used to forecast contrails are shown on a plotted Skew-T in Figure 2-74. Construct a scaled overlay of Figure 2-74 for your Skew-T and use it to find the temperature and relative humidity necessary for the formation of contrails in the wake of a jet aircraft flying at a particular pressure level.

At a particular flight altitude, the flight altitude temperature and relative humidity values are required to make a “yes” or “no” contrail forecast.

- If flight altitude temperature is to the right of the 100 percent curve, forecast no contrails regardless of the relative humidity;
- If flight altitude temperature is left of the zero percent curve, always forecast contrails no matter what the relative humidity;
- And if flight altitude temperature is between the 0 and 100 percent curves, both the relative humidity and the flight altitude temperature are needed to forecast contrails.
 - Contrails form only if the actual relative humidity is equal to or greater than the value indicated at that point on the graph (called the uncertain or possible area).
 - If the humidity along the route is unknown, assume a 40 percent relative humidity if there are no clouds and a 70 percent relative humidity if there are clouds.

The accuracy of contrail forecasts is degraded by uncertainties in measuring relative humidity at high altitudes. Use the empirical data in Table 2-16 to

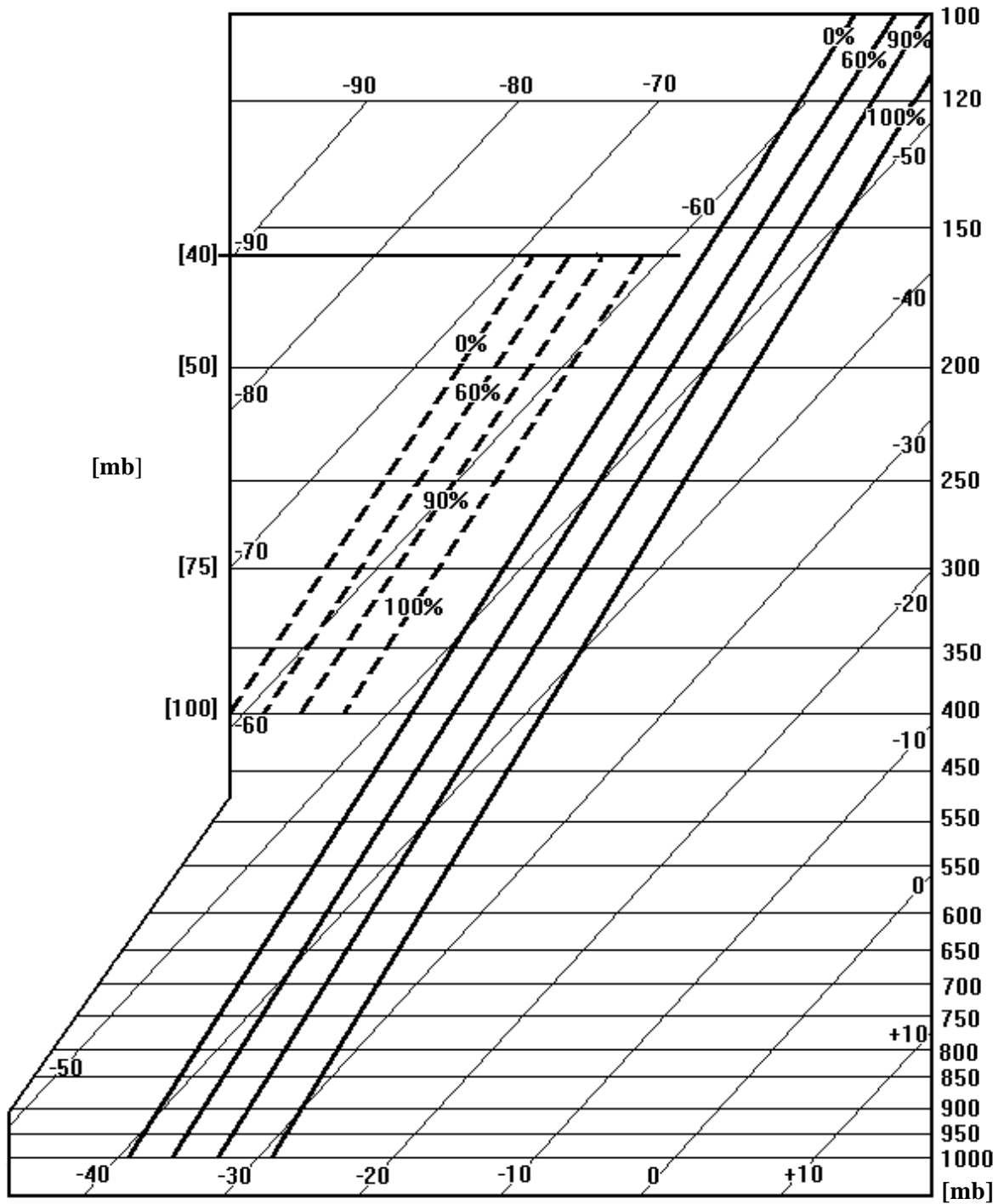

Figure 2-74. Jet Contrail Curves on Skew-T. Critical relationships between pressure, temperature, and relative humidity used to forecast contrails are shown in the figure. Dashed lines and brackets indicate curves in the 100- to 40-mb region.

Table 2-16. Probability of Contrail Formation. Enter table with temperature at altitude of interest and read up to get probability.

Contrail Probability							
Pressure (mb)	95%	90%	75%	50%	25%	10%	5%
150	-60.5°C	-59.3°C	-57.1°C	-55.5°C	-53.6°C	-51.5°C	-50.7°C
175	-58.8°C	-57.4°C	-55.3°C	-53.6°C	-51.4°C	-49.6°C	-48.5°C
200	-58.5°C	-56.6°C	-54.8°C	-53.1°C	-51.0°C	-48.5°C	-47.0°C
250	-58.1°C	-56.3°C	-53.8°C	-52.2°C	-50.1°C	-47.1°C	-45.3°C
300	-55.5°C	-54.0°C	-52.0°C	-50.7°C	-49.1°C	-46.3°C	-44.3°C
350	N/A	-49.9°C	-49.4°C	-49.0°C	-48.0°C	-45.9°C	-43.6°C

estimate contrail probabilities when accurate upper-air temperature and relative humidity data are not available.

Apply the flight altitude and temperature at flight time in Table 2-16 to get the contrail probability. For example, at an altitude of 250 mb and a temperature of -52°C, there is a 50 percent probability of contrail formation.

E. D-VALUES. Pilots use D-values for navigation when more reliable navigation aids are not available. D-values describe the departure of the height of a pressure surface from its standard height. They can

be calculated from the equation: $D = Z_a - Z$, where D is the D-value, Z is the standard height (pressure altitude), and Z_a is the actual height. The following tools are useful in determining D-values:

- 1. Skew-T.** The easiest tool to use since it presents both actual and standard heights.
- 2. Upper-Air Data.** Read heights directly from the bulletin and subtract from standard heights shown in Table 2-17.
- 3. Upper-Air Products.** Interpolate heights and subtract from heights shown in Table 2-17.

Table 2-17. Standard atmosphere.

U. S. Standard Atmosphere									
Altitude (ft)	Pressure Temperature				Altitude (ft)	Pressure Temperature			
	Millibars (mb)	Inches of Hg	°C	°F		Millibars (mb)	Inches of Hg	°C	°F
0	1,013.2	29.92	15.0	59.0					
1,000	977.2	28.86	13.0	55.4	26,000	359.9	10.63	-36.5	-33.7
2,000	942.1	27.82	11.0	51.9	27,000	344.3	10.17	-38.5	-37.3
3,000	908.1	26.82	9.0	48.3	28,000	329.3	9.72	-40.5	-40.9
4,000	875.1	25.84	7.1	44.7	29,000	314.8	9.30	-42.5	-44.4
5,000	843.1	24.90	5.1	41.2	30,000	300.9	8.89	-44.4	-48.0
6,000	812.0	23.98	3.1	37.6	31,000	287.4	8.49	-46.4	-51.6
7,000	781.8	23.09	1.1	34.0	32,000	274.5	8.11	-48.4	-55.1
8,000	752.6	22.22	-0.8	30.5	33,000	262.0	7.74	-50.4	-58.7
9,000	724.3	21.39	-2.8	26.9	34,000	250.0	7.38	-52.4	-52.2
10,000	696.8	20.58	-4.8	23.3	35,000	238.4	7.04	-54.3	-65.8
11,000	670.2	19.79	-6.8	19.8	36,000	227.3	6.71	-56.3	-69.4
12,000	644.4	19.03	-8.8	16.2	37,000	216.6	6.40	-56.5	-69.7
13,000	619.4	18.29	-10.8	12.6	38,000	206.5	6.10		
14,000	595.2	17.58	-12.7	9.1	39,000	196.8	5.81	Constant to	
15,000	571.8	16.89	-14.7	5.5	40,000	187.5	5.54	65,600 Feet	
16,000	549.2	16.22	-16.7	1.9	41,000	178.7	5.28		
17,000	527.2	15.57	-18.7	-1.6	42,000	170.4	5.04		
18,000	506.0	14.94	-19.7	-5.2	43,000	162.4	4.79		
19,000	485.5	14.34	-22.6	-8.8	44,000	154.7	4.57		
20,000	465.6	13.75	-24.6	-12.3	45,000	147.5	4.35		
21,000	446.4	13.18	-26.6	-15.9	46,000	140.6	4.15		
22,000	427.9	12.64	-28.6	-19.5	47,000	134.0	3.96		
23,000	410.0	12.11	-30.6	-23.9	48,000	127.7	3.77		
24,000	392.7	11.60	-32.5	-26.6	49,000	121.7	3.59		
25,000	376.0	11.10	-34.5	-30.2	50,000	116.0	3.42		

Chapter 3

CONVECTIVE WEATHER

I. THUNDERSTORMS. There are three basic storm types: single cells, multi-cells and supercells. This section will cover each storm type, unique characteristics of each, and associated severe weather. Thunderstorm-produced severe weather may consist of a combination of tornadoes, hail, strong winds, lightning, and heavy rainfall.

While upward vertical motions and instability of an air mass determine whether thunderstorms will occur, wind shear strongly influences the type of thunderstorms to expect. Other conditions being the same (and favorable to thunderstorm formation), the greater the shear, the more likely the convection will be sustained. Each type of storm can be identified by a distinctive hodograph pattern, a visual depiction of the wind shear. AWS/FM-92/002 describes hodograph construction and use. The SHARP computer program will produce hodographs from RAOB soundings. Both are available from the AFWTL. Knowing expected storm type is key to predicting severe weather.

A. THUNDERSTORM TYPES

1. Single Cell. Single-cell storms are short-lived (30 to 60 minutes) with one updraft that rises rapidly through the troposphere. Precipitation begins at the mature stage as a single downdraft. When the downdraft reaches the surface, it cuts off the updraft and the storm dissipates. Figure 3-1 is a typical diagram of a hodograph for a single-cell storm.

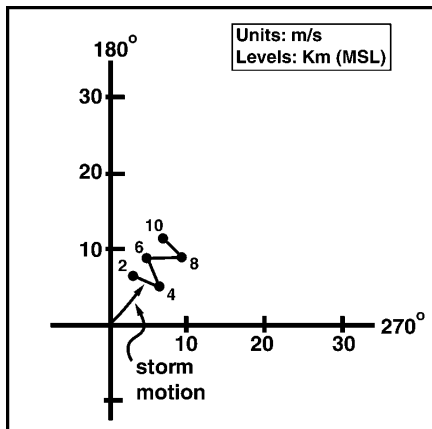

Figure 3-1. Single-Cell Storm Hodograph.

a. Single-cell Storm Indicators.

- Weak vertical and horizontal wind shear.
- The shear profile on the hodograph has a random pattern.
- Storm motion is with the mean wind in the lowest 5 to 7 km.

b. Associated Severe Weather.

- Tornadoes are rare.
- Short-lived high winds and hail are possible.

Watch developing cells using weather radar. When severe weather occurs in single-cell storms, it usually is in the stronger and longer-duration cells. Individual cells develop stronger core reflectivity at higher elevations than surrounding cells and must be closely monitored.

2. Multicellular. Multicellular storms are clusters of short-lived single-cell storms. Each cell generates a cold outflow that can combine to form a gust front. Convergence along this boundary causes new cells to develop every 5 to 15 minutes in the convergent zone. These storms are longer in duration than single-cell storms because they typically regenerate along the gust front. Figure 3-2 is a typical hodograph for a multicellular storm.

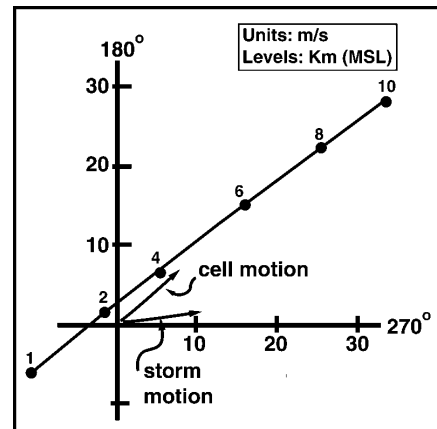

Figure 3-2. Typical Multicell Storm Hodograph.

a. Multicellular Storm Indicators.

- A straight-line or unidirectional shear profile.
- Strong directional shear in the lower levels, and strong speed shear aloft.
- Cell motion coincides with mean wind.
- Storm clusters propagate in the direction of the gust front and to the right of the mean wind.

b. Associated Severe Weather.

- Flash flooding from slow-moving cells.
- Large hail near downdraft centers.
- Short-duration tornadoes possible along gust fronts near updraft centers.

3. Supercell. Supercell thunderstorms consist of one quasi-steady rotating updraft, a forward-flanking downdraft that forms the gust front, and a rear-flanking downdraft. These storms exist for several hours and are a frequent producer of severe weather. There are three types of supercells: classic, high precipitation (HP), and low precipitation (LP). The hodograph for a supercell is pictured in Figure 3-3. The following indicate supercell storms:

- Wind speed increases with height.
- Shear vector veers with height in the lower levels, which can produce storm updraft rotation.
- Curved shear profile in lower levels becoming straight-line above 3 km.
- At least 70 degrees of directional shear in the first 3 km. Average amount of shear for a supercells is 90 degrees.
- A “cyclonically curved” hodograph, as shown in Figure 3-3, is associated with cyclonically rotating cells that move to the right of the mean (surface - 6 km) wind. “Anticyclonically curved” hodographs indicated storms moving to the left of the mean wind; These storms are notorious hail producers.

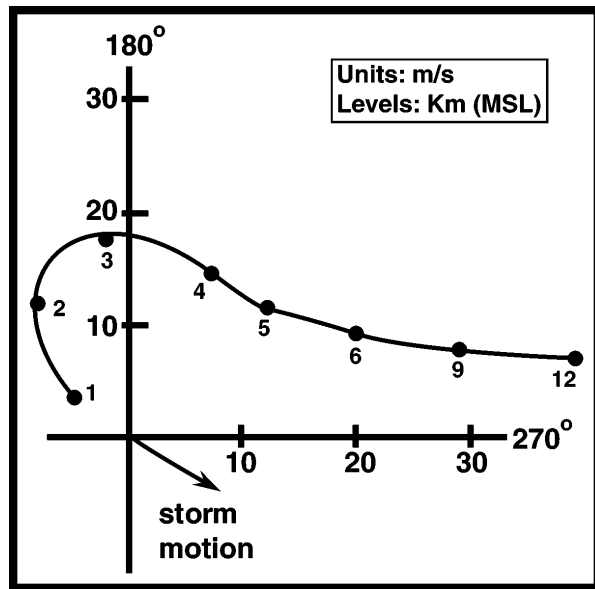

Figure 3-3. Supercell Hodograph. The figure shows a cyclonically curved hodograph.

a. Classic Supercells (Figure 3-4). Classic supercells are usually isolated per thunderstorm outbreak and are identified by the classic “hook echo” in the low-level reflectivity pattern and

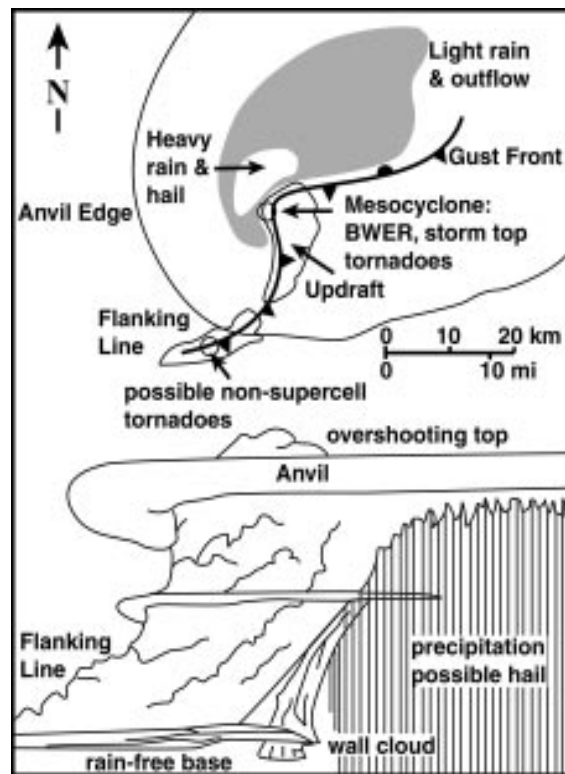

Figure 3-4. Classic Supercell. These supercells are identified by a “hook echo” in the low-level reflectivity pattern.

bounded weak-echo region (BWER) aloft. These cells have the following associated severe weather:

- Golf ball-size hail.
- Possible tornadoes.
- Wind gusts in excess of 50 knots (along the gust front and from microbursts in the rear-flanking downdraft).

b. High Precipitation (HP) Supercells (Figure 3-5). These develop in deep moist layers with high moisture values. They are more common the further east you go from the Plains. They produce heavier rain than classic supercells and are not as isolated as these storms. Radar patterns associated with HP storms are more varied than the classical “hook”. HP storms have the potential to evolve into bow echo configurations. Associated severe weather includes the following:

- Very heavy rain.
- Tornadoes and hail possible.

c. Low Precipitation (LP) Supercells (Figure 3-6). These storms are most commonly found along the dryline of west Texas. They produce some precipitation but have a rather “benign” appearance on radar. Although smaller in diameter than classic supercell storms, they are still capable of producing severe weather. These cells have the following associated severe weather:

- Large hail.
- Tornadoes.

4. Dry, Wet, and Hybrid Microbursts. Downbursts are dynamically enhanced concentrated downdrafts from thunderstorms that result in damaging winds with gusts of 50 knots or greater

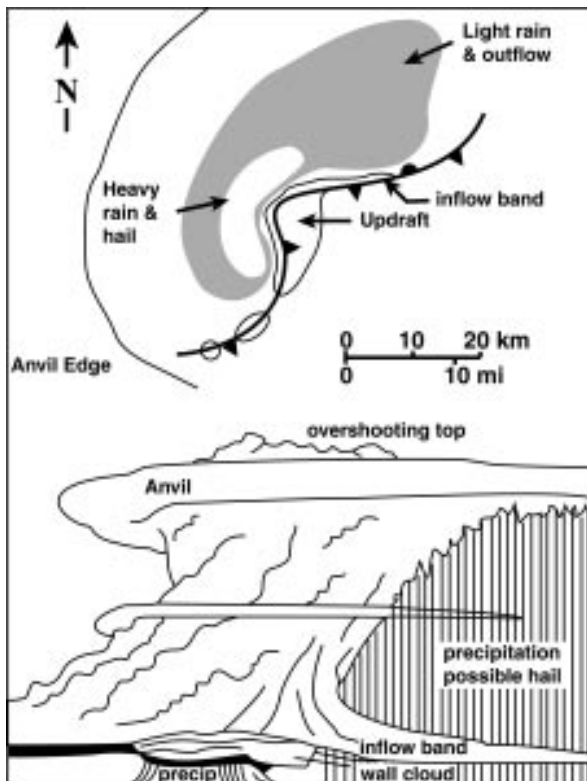

Figure 3-5. Typical High Precipitation (HP) Supercell. These supercells develop in deep, moist layers with high moisture values.

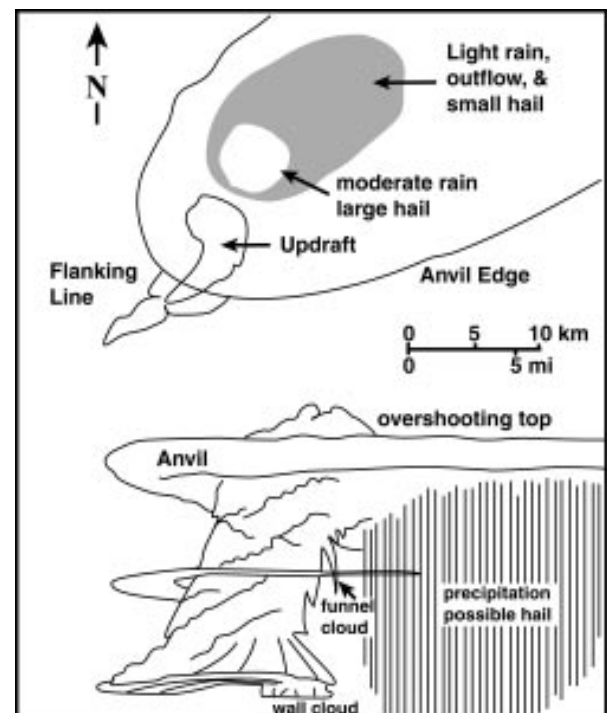

Figure 3-6. Low Precipitation (LP) Supercell. These storms occur most often along the dryline of west Texas.

at the surface. These usually occur in the rear-flanking downdraft region of supercell storms and may also be found behind the gust front. Downbursts/microbursts, however, are not restricted to large supercell storms; they can come from innocuous-looking, high-based rain clouds (dry microbursts) and from single- and multicellular pulse storms (wet microbursts), or from hybrid microbursts that combine dry and wet extremes. The microburst type depends on the type of environment where the formation of the storm takes place.

Figure 3-7a-c portrays typical atmospheric profiles for dry, wet, and hybrid microbursts. Currently, there is no method for predicting precisely when and where a microburst will occur, but if the environment is conducive to microburst occurrence, then the possibility for a microburst event can be incorporated into the forecast.

5. *Derechos*. Derechos are straight line winds from severe convective storms. There are two types of derechos. The first are rapidly propagating segments of an extensive squall line associated with a strong, migratory low-pressure system that occurs late winter and spring. The second type develops in association with a relatively weak frontal system in a moisture-rich environment, showing characteristics of both squall lines and nonlinear types of MCSs, and is a late spring and summer event. They predominately occur along an axis from southern Minnesota through the Ohio River Valley but are not limited to that region.

II. SYNOPTIC PATTERNS. This section describes five basic severe thunderstorm-producing synoptic weather patterns for mid-latitudes and describes three well-acknowledged parameters used to identify areas for thunderstorm development: mid-level jets or shears; dry-air intrusions between 850 mb and 700 mb; and low-level moisture gradients. These parameters have proven to be useful to identify severe thunderstorm triggering mechanisms, and forecasting when and where severe thunderstorm outbreaks will occur in each of the synoptic patterns. Stability index usage for thunderstorm forecasting is covered later.

Mid-level jets can be used to determine areas of thunderstorm and tornado development. Mid-level

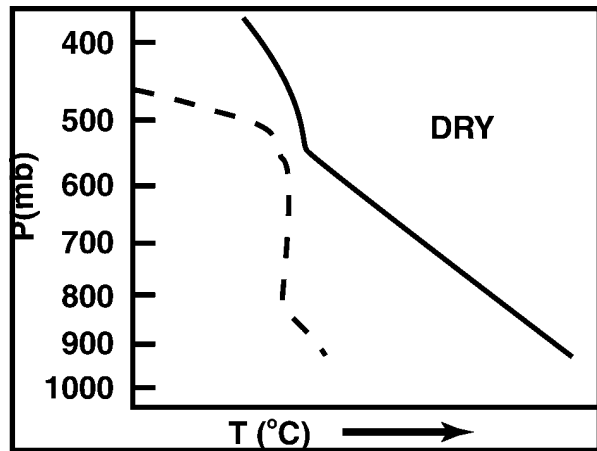

Figure 3-7a. Dry Microburst Atmospheric Profile. Typical atmospheric profile for dry microbursts.

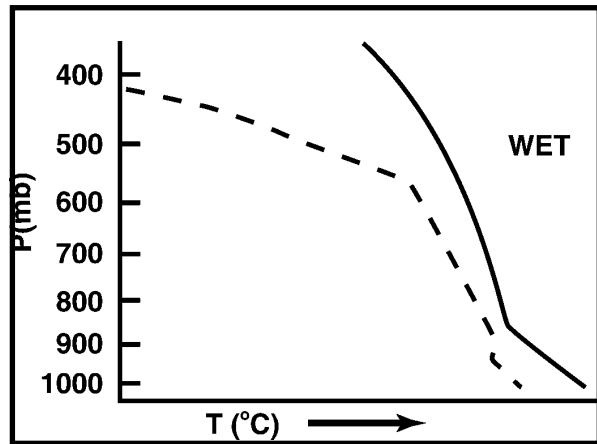

Figure 3-7b. Wet Microburst Atmospheric Profile. Typical atmospheric profile for wet microbursts.

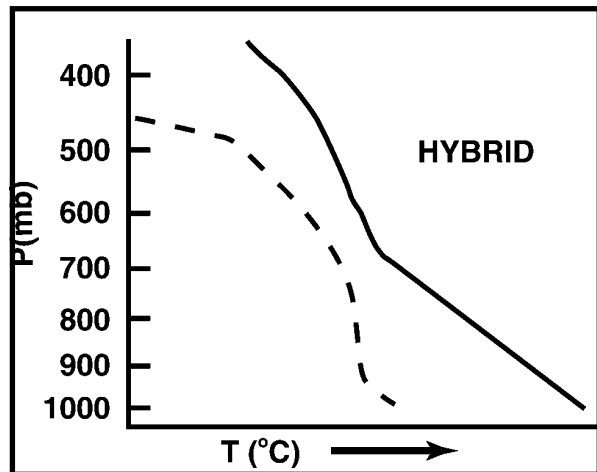

Figure 3-7c. Hybrid Microburst Atmospheric Profile. Typical atmospheric profiles for hybrid microbursts.

Table 3-1. Severe thunderstorm development potential.

Parameters	Weak	Moderate	Strong
Jet Speed	35 kt	35-50 kt	>50 kt
Horizontal Shear	15 kt/90 NM	15-30 kt/90 NM	>30 kt/90 NM
Winds crossing the axis of 700-mb dry intrusions and moisture boundaries	Less than 20° or not at all	20-40°	Greater than 40°
Surface Dew Point	< 13°C	13-18°C	> 18°C
850-mb Dew Point	< 8°C	8-12°C	> 12°C

jets are wind speed and shear maxima that occur between 10,000 and 20,000 feet, or roughly 700 mb to 500 mb. These jets should not be confused with upper-level polar front and subtropical jet streams. Table 3-1 shows an empirical relationship between threshold values for mid-level jet speeds and shear parameters and potential for severe thunderstorm development.

Dry-air intrusions between 850 mb and 700 mb are a major triggering mechanism for tornadoes and can be used to pinpoint areas of potential severe thunderstorm development. Dry-air intrusions are difficult to identify by a particular temperature/dew point spread or relative humidity since the values vary from case to case. They can often be identified by looking at the intensity with which the drier air is being forced into the moist air. Table 3-1 also shows an empirical relationship between the angle of the 700-mb winds and the dry-air intrusion axis, and severe thunderstorm potential.

Almost all severe thunderstorm outbreaks are associated with strong low-level (below 700 mb) moisture gradients except in the case of winds greater than or equal to 50 knots associated with dry microbursts. The moisture axes are generally located on the windward side of the outbreak area. The intensity of the storm is usually proportional to

the tightness of the moisture gradient along the wind component from dry to moist air.

Note: When the 850-mb or 925-mb product is not representative of moisture below 700 mb, the moisture gradient can often be determined from satellite imagery and computer-generated vertical cross sections.

A. FIVE CLASSIC SYNOPTIC CONVECTIVE WEATHER PATTERNS. Five classic synoptic severe weather patterns are generally associated with the development of severe mid-latitude thunderstorms. The characteristics of the thunderstorm outbreak area(s), triggering mechanism(s), and timing rule(s) are identified for each of the patterns. Pattern recognition provides clues to which type of weather severity is possible in each situation.

Keep in mind these weather patterns are idealized, and various elements used to define the synoptic patterns may be located or oriented differently in other areas of interest. In some instances, more than one pattern may apply to one area. Look for a “best fit” of the weather patterns to the area of interest.

Note: Air-mass (pulse) thunderstorms, (thunderstorms not associated with any recognizable frontal systems) are covered later in this chapter.

1. Type A Thunderstorm Pattern, “Dryline.”
(Figure 3-8).

a. Pattern Characteristics.

- Well-defined southwesterly 500-mb jet.
- Distinct, warm dry-air intrusion from the southwest, surface to 700 mb.
- Considerable streamline confluence (850 mb to 700 mb) along the dry line.
- Low-level moisture (surface to 850 mb) advection from the south, ahead of dry air.
- Convective development characterized by unusually rapid growth (15 to 30 minutes) from inception to maturity with almost immediate production of very large hail, damaging winds, and tornadoes (usually in groups or families).

b. Initial Outbreak Area.

- Storms are usually confined to the edges of the dry air at 850 mb and 700 mb.
- The convergence zone between the moist and dry air (area of maximum gradient from dry to moist air).
- These storms form rapidly, in isolated clusters, along the leading edge of the dry intrusion. (Sharp, well-defined squall lines are not common with this pattern.)

c. Severe Weather Area.

- Severe thunderstorms often extend along and to about 200 miles to the right of the 500-mb jet (in the diffluent zone), and from the maximum low-level convergence, downstream to the point where the low-level moisture decreases to a value

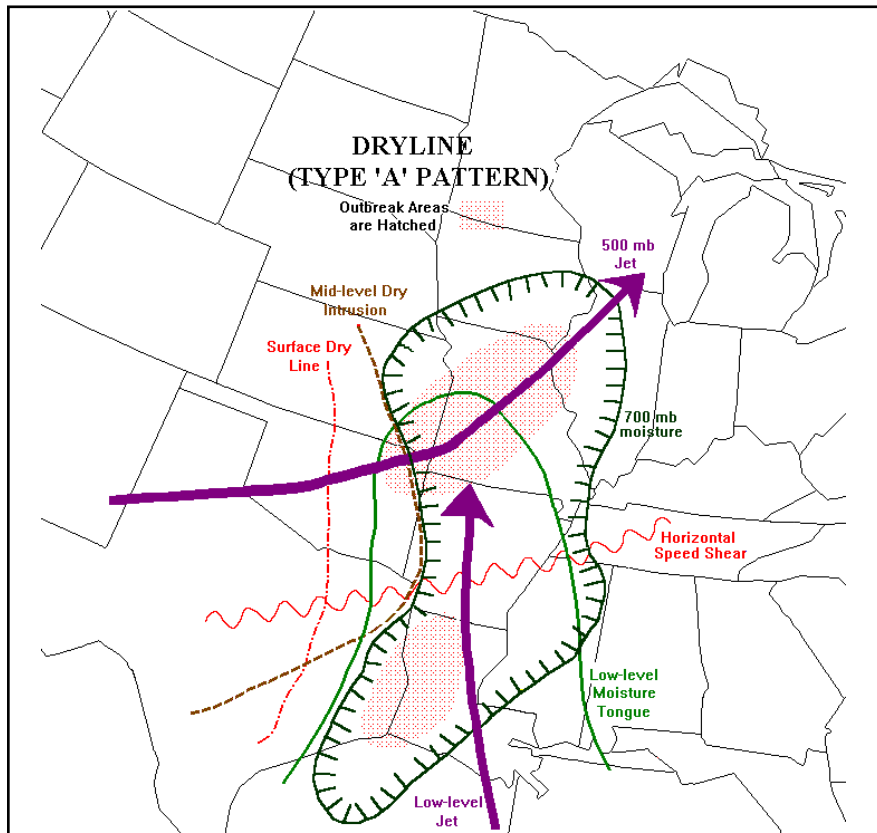

Figure 3-8. Type “A” Thunderstorm Pattern. The most violent storms usually form where the jet meets the moist and dry-air convergence zone.

insufficient to support severe weather. The most violent storms usually form where the jet meets the moist and dry-air convergence zone.

- A secondary severe weather outbreak area may be located along and 150 miles to the right of the 500-mb horizontal speed shear zone, and from the maximum low-level convergence, downstream until a decrease in sufficient moisture to produce severe weather.

d. Triggering Mechanisms.

- Maximum diurnal heating.
- Passage of the upper-level jet maximum.
- A low-level intrusion of warm, moist air.
- Dry air moving into a low-level moist region.

e. Timing.

- Thunderstorms begin about the time of maximum heating.
- Convection is usually suppressed by an inversion until the convective temperature is reached.
- The activity usually lasts 6 to 8 hours, or until the mixing of moist and dry air masses is complete and low-level winds diminish.

2. Type B Thunderstorm Pattern, “Frontal” (Figure 3-9). The convective development pattern is characterized by prefrontal squall lines with one or more mesoscale lows (25 to 100 miles in diameter) that form at the intersection of the low-level jet (850 mb) and the 500-mb jet. Mesoscale lows may form in the area of the intersection of the

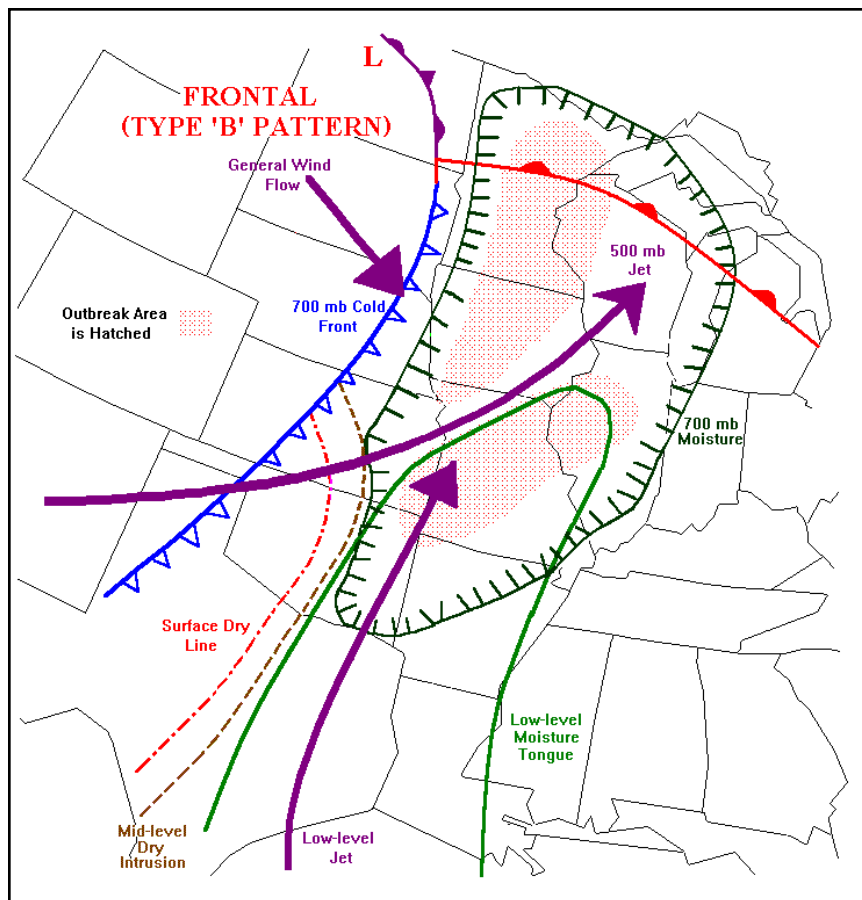

Figure 3-9. Type “B” Thunderstorm Pattern. Tornado families are usually associated with any mesoscale lows that form.

low-level jet and the warm front. Tornado families are usually associated with any mesoscale lows that form.

a. Pattern Characteristics.

- Well-defined southwesterly jet at 500 mb.
- Well-defined dry intrusion (surface to 700 mb).
- Strong low-pressure center, cold and warm fronts.
- Frontal and prefrontal squall lines almost always form.
- Strong cold-air advection behind the cold front (surface to 500 mb).
- Warm low-level (surface to 850 mb) jet transporting moisture from the south.
- Cool, moist air at the 700-mb and 500-mb cold trough axes, which lie to the immediate west of the threat area.
- Considerable low- and mid-level streamline confluence at altitudes between the low-level warm, moist air and the cooler air aloft.

b. Initial Outbreak Area.

- Mesolows may form at the intersection of the low-level jet and the warm front.
- Location depends on the speed of the cold front and the dry surge into the moist air.
- The severe weather area extends along and 200 miles to the right of the 500-mb jet (in the diffluent zone) and from the dry intrusion to where the low-level moisture becomes insufficient to support severe weather activity.
- Initial outbreak usually occurs along or just ahead of the surface cold front in the region where strong upper-level cold-air advection, strong low-level warm moist advection, and southwesterly dry intrusion all occur. The outbreak area occurs in the

area of maximum cold-air advection (500 mb) and dry-air advection at 850 mb and 700 mb.

c. Secondary Outbreak Area.

- Squall lines often form about 150 to 200 miles north of the jet, extending south to the leading edge of the dry-air intrusion.
- Located along and 150 miles to the right of the horizontal speed shear zone and from the dry intrusion to where the low-level moisture becomes insufficient to support further activity.

d. Triggering Mechanisms.

- Movement of the dry line.
- Intersection of low-level jet (850 mb) with the warm front.
- Intersection of the low-level jet (850 mb) with the 500-mb jet.
- Intersecting lines of discontinuity (i.e., squall lines, jet streams, and/or fronts).

e. Timing.

- Anytime; may last all day and night (doesn't depend on diurnal heating).
- Will last as long as the air mass ahead of the squall remains absolutely unstable.

Note: On rare occasions, the severe activity may last longer if the dry line is driven by a 30-knot or greater wind from the surface through 700 mb.

3. Type C Thunderstorm Pattern, "Overrunning" (Figure 3-10). The area of overrunning-produced thunderstorms is enhanced by dry intrusions. The outbreak area is favorable for the development of mesoscale lows and mesoscale highs. These mesoscale features move in a direction 30 degrees to the right of the 500-mb flow toward higher temperatures and lower pressures. There are intense pressure gradients around these mesoscale features. Tornadoes occur either singly or by two's and three's separated by

25 to 50 miles. This pattern changes to a Squall Pattern if a well-defined cold front accompanied by strong cold-air advection overtakes the active thunderstorm area.

a. Pattern Characteristics.

- East-west stationary frontal zone with warm, moist tropical overrunning air.
- West-southwest to west-northwest positioned 500-mb jet, or a strong 500-mb westerly horizontal wind speed shear zone.
- Dry intrusion from the southwest present at 700 mb. (if a dry intrusion doesn't exist, severe thunderstorms are not likely.)
- Tornadoes may occur with surface dew points of 50°F (14°C) or higher. Release of latent heat is usually considered fuel for combustion.

Widespread large hail and damaging winds may also be present.

b. Initial Outbreak Area.

- Scattered thunderstorms develop on and to the north of the front as a result of overrunning.
- Thunderstorm activity reaches severe limits as the squall line forms along the leading edge of the dry intrusion.
- Hail producer if the Wet-bulb zero height is favorable for severe weather.
- Severe weather threat area occurs between the 500-mb jet and the stationary front. The western edge of activity extends for 50 miles west of the axis of maximum overrunning, and the eastern edge depends on a decrease in temperature lapse rate and/or a decrease in overrunning.

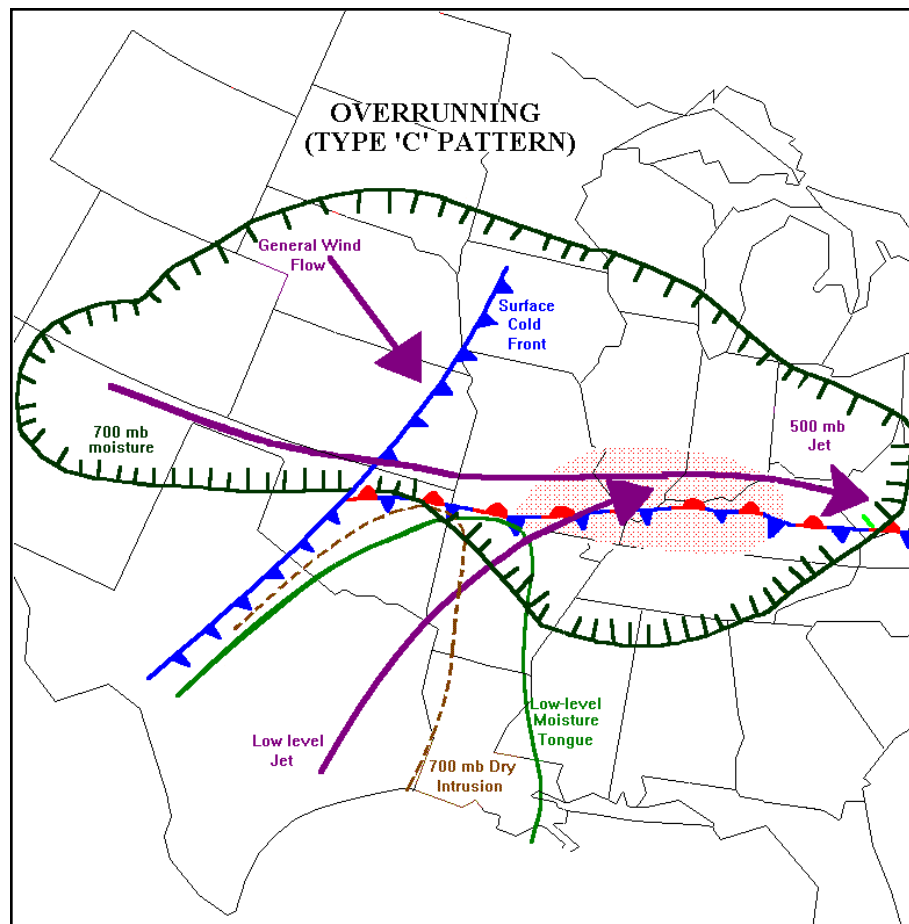

Figure 3-10. Type “C” Thunderstorm Pattern. Tornadoes occur either singly or by two’s and three’s separated by 25 to 50 miles.

- Usually no area of secondary outbreaks.

c. Triggering Mechanisms.

- Overrunning.
- Maximum diurnal heating.
- Severe storms triggered by a dry intrusion moving into an area of active storms.

d. Timing.

- When the dry intrusion is lost, storm intensity falls below severe criteria.
- Maximum activity occurs for 6 hours after maximum heating or when a dry intrusion enters the area.

4. Type D Thunderstorm Pattern , “Cold Core” (Figure 3-11). Widespread storms produce hail and numerous funnel clouds; tornadoes occur singly, not in families, and they seldom occur.

a. Pattern Characteristics.

- Deep southerly 500 mb jet.
- Surface low deepening.
- 500-mb cold-core low.
- Cool, dry-air advection at all levels around the bottom of the low.
- Low-level jet advecting warm, moist air from south-southeast toward the north and under the cold air aloft.

b. Initial Outbreak Area.

- Hail of increasing frequency and size westward from the jet to the 500-mb cold-core low.
- In the warm, moist under-running air between the 500-mb jet and the cold closed isotherm center at 500 mb.

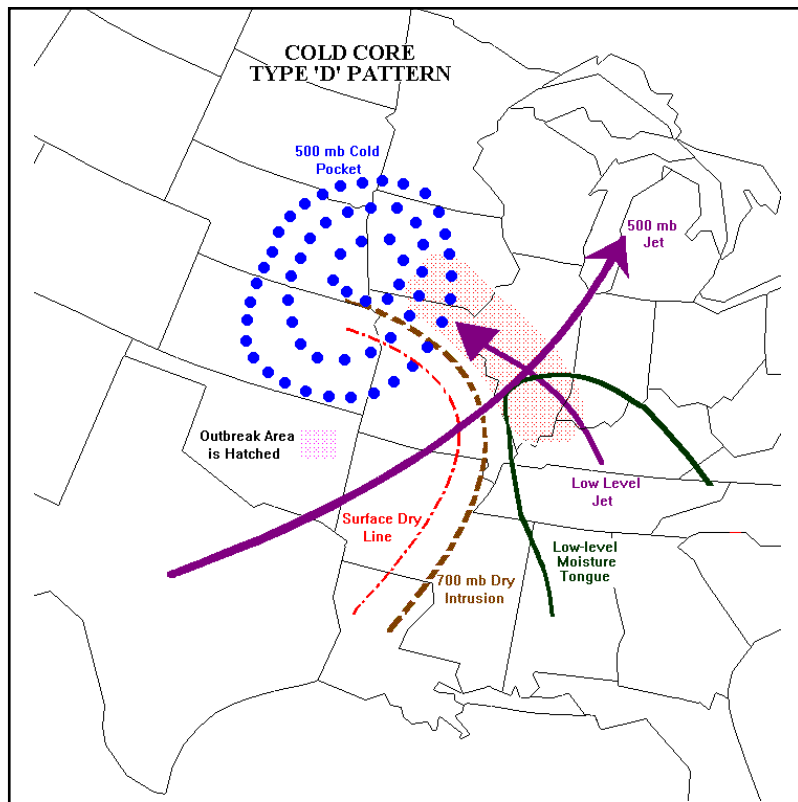

Figure 3-11. Type D Thunderstorm Pattern , “Cold Core.” Widespread storms produce hail and numerous funnel clouds, but tornadoes seldom occur.

- Severe weather extends from approximately 150 miles to the right of the 500-mb jet to the cold core low center and from the intense low-level confluence ahead of the dry intrusion (southwest boundary) to the east and northeast limit of the under-running unstable warm, moist air.

c. Triggering Mechanisms.

- Intense low-level wind confluence.
- Increasing instability caused by the 500-mb cold-air advection over the low-level warm moist advection.

d. Timing.

- Weaker storms can occur at any hour.
- Intensity of storms decreases rapidly after sunset.

- The most violent storms occur between noon and sunset, during maximum diurnal heating.

5. Type E Thunderstorm Pattern, “Squall Line” (Figure 3-12). Frontal or prefrontal squall lines are almost always well defined.

a. Pattern Characteristics.

- Well-defined westerly jet at 500 mb.
- Well-defined dry source bounded by a 700-mb warm sector.
- Considerable low-level convergence and a squall line forms in virtually all cases.
- Moderate to strong south to southwest low-level flow advecting warm moist air over cooler air (usually ahead of a warm front).

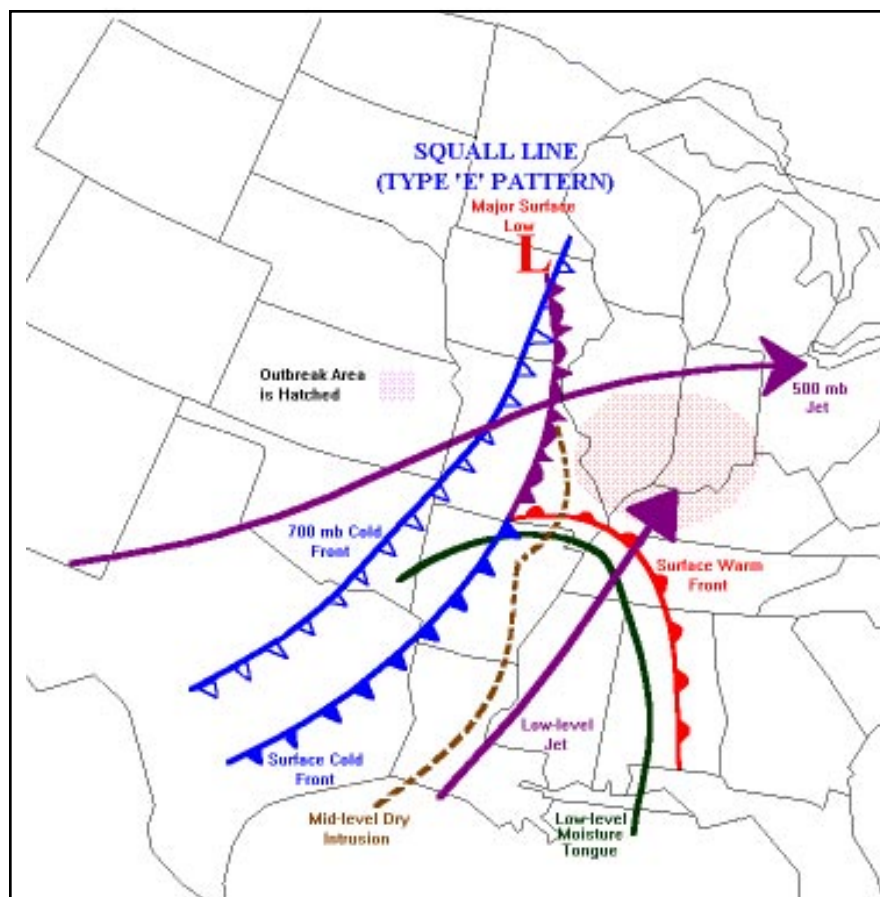

Figure 3-12. Type E Thunderstorm Pattern, “Squall Line.” Maximum severe activity, both quantity and intensity, occur from maximum heating to a few hours after sunset.

b. Initial Outbreak Areas.

- Severe weather usually extends along and south of the 500-mb jet but north of the 850-mb warm front and from the 700-mb cold front to the place where instability decreases to a value insufficient to support severe activity.

- Thunderstorms form in the overrunning moist air between the 850-mb warm front and the upper-level jet axis where the 700-mb dry-air intrusion meets the frontal lifting of the warm, moist low-level air and the strong 500-mb cold-air advection.

c. Secondary Outbreak Areas.

- If the 700-mb dry intrusion extends to the south of the 850-mb warm front, outbreaks can occur along the 500-mb horizontal speed shear zone and along transitory, but active, squall lines.

d. Triggering Mechanisms.

- Diurnal heating.
- 700-mb dry intrusion moves into threat area.
- Frontal lifting of warm moist air triggers the initial outbreak.
- Cold-air advection at 500 mb into threat area increases severity of storms.

e. Timing.

- Onset of 500-mb cold-air advection into threat area.
- Maximum severe activity, both quantity and intensity, occur from maximum heating to a few hours after sunset.
- Many severe thunderstorms continue until midnight, or until the air mass becomes too stable to produce severe activity.

III. CONVECTIVE WEATHER TOOLS. The thermal stability or instability of a column of air can be conveniently expressed as a single numerical value called a stability index. These indices are aids

for forecasting thunderstorms and should not be used as the sole basis for making a thunderstorm forecast. Detailed procedures for calculating many of these indices can be found in AWS/TR—79/006. See also various PC programs such as SHARP or Skew-T Pro, available from the AFWTL.

A. STABILITY INDICES

1. Convective Available Potential Energy (CAPE). This is a measure of the convective instability of the atmosphere and, thus, thunderstorm potential. It is calculated using the most unstable parcel in the lowest third of the atmospheric model. CAPE values are not a direct indicator of severe weather. They should be used in conjunction with helicity (a measure of the rotation potential of a column of air) for forecasting severe weather. Use values above 200 J/kg in conjunction with helicity to determine conditions for tornadic thunderstorms and severe weather. Be aware that violent thunderstorms and tornadoes are associated with a wide range of values.

2. Bulk Richardson Number (BRN). The BRN is a better indicator of storm type than of storm severity or storm rotation. It is useful in differentiating between weak, multicellular storms (non-severe) and super-cell-storm (severe) types. The BRN is a measure of turbulent energy (a ratio of buoyancy to vertical wind shear) in a column of air to enhance or hinder convective activity

- Works best when CAPE index is 1,500 to 3,500 J/kg.
- When CAPE is less than 1,000 J/kg and accompanied by moderate wind shear, the BRN value may indicate supercells, but the lack of buoyancy is likely to inhibit severe weather occurrence.
- When CAPE is greater than 3,500 m^2/s^2 with a moderate wind shear environment, BRN values may suggest multicellular storms (non-severe storms), but the buoyant energy will be sufficient to produce tornadoes and large hail.

Note: Using BRN might not be as useful for predicting tornado development as it is for predicting multi- vs super-cell type thunderstorm.

Strong tornadoes have developed in environments with BRN values ranging from 0 to 40.

3. Cross Totals (CT). Cross Totals is most effective for thunderstorm coverage and severity east of the Rockies and along the Gulf Coast. It measures a combination of low-level moisture and upper-level temperature. The CT value is contingent on the low level moisture band being at 850 mb and a cold air pocket at the 500 mb level. If the moisture and cold air are centered slightly above or below these levels, CT values will not be a reliable indicator of thunderstorm coverage or severity.

4. Dynamic Index. This index is designed for air-mass thunderstorms. Positive values indicate stability, and negative numbers indicate a conditionally unstable air mass. A triggering mechanism is needed for thunderstorms to occur when conditionally unstable, diurnal heating is usually enough to trigger the convection.

5. Energy/Helicity Index (EHI). Use this index only if strong thunderstorms are forecast. As mentioned previously, CAPE cannot be used alone to forecast severe weather. EHI is a combination of CAPE and Storm-Relative Helicity (S-RH), which measures the contribution of convective instability of the atmosphere and the shear vorticity to the potential for tornado formation. Strong to violent tornadoes are associated with a wide range of CAPE values: large CAPE values combined with low wind shear, and conversely, low CAPE values combined with high wind shear are both capable of producing conditions favorable for the development of tornadoes (mesocyclogenesis).

6. Fawbush-Miller Stability Index (FMI). This index is similar to the Showalter Stability Index, except it emphasizes the low-level (surface) moisture rather than the 850-mb moisture. The FMI can be more representative than the Showalter Index, however, computation of the FMI is definitely more difficult (Ref: AWS/TR-79/006). Use only when the Showalter appears to be misrepresenting the low level moisture.

7. GSI Index. This index was developed for use in the central Mediterranean using the following procedure:

Step 1. Obtain the minimum temperature/dew point spread ($^{\circ}\text{C}$) between 650 mb and 750 mb

Step 2. Obtain the average wet-bulb temperature in the lowest 100 mb by the equal area method. From this point, follow the saturation adiabat to the 500-mb level. Subtract the temperature were the saturation adiabat crosses 500 mb from the observed 500-mb temperature ($^{\circ}\text{C}$).

Step 3. Add the values from Step 1 and Step 2 above to calculate GSI.

Example: If the saturation adiabat crosses the 500-mb level at -20°C , and the observed 500-mb temperature is -15°C , then the value would be -5 .

8. K Index (KI). The K Index is primarily used to forecast heavy rain and thunderstorm potential. It is not a good indicator of severe vs non-severe weather. The K index was developed for pulse (air-mass) thunderstorm forecasting. It works best in the summer east of the Rockies in maritime-tropical (mT) air masses and in any tropical region. It has limited use in overrunning situations and in mountainous regions.

Note: KI Values over 35 represent heavy rain potential and a flood threat, especially when a series of storms travel over the same area.

9. KO Index (KO). The KO index, created by the German Weather Bureau, is sensitive to moisture and works best for cool moist climates (mP), (i.e., Europe, Pacific Northwest). The KO Index's drawback is its complexity. Unlike most other indices, the standard Skew-T programs do not calculate it. The KO equation is:

$$\text{KO} = \frac{(\theta_{e_{500}} + \theta_{e_{700}})}{2} - \frac{(\theta_{e_{850}} + \theta_{e_{1000}})}{2}$$

(Where θ_e is the equivalent potential temperature at a given level.)

To find θ_e , first find the lifting condensation level (LCL) for the given pressure level. Continue up the moist adiabat until all moisture is removed from the parcel. This occurs at the level where the moist and dry adiabats become parallel. From there, continue up the dry adiabat to the top edge of the

chart. There, read θ_e directly. Do this for each of the four pressure levels in the equation and plug into the equation. The result is the KO index. (Ref: AWS/FM-90/001)

10. Lifted Index (LI). The LI can be used successfully at most locations since it contains a good representation of the low-level moisture. This index counters deficiencies in the Showalter Index when low-level moisture and/or inversions are present. The LI fails to consider destabilizing effects of cold air above 500 mb. Threshold values generally are lower than Showalter Index.

11. Mean Storm Inflow (MSI). Use the SHARP computer program to derive the MSI index. It measures the potential strength of inflow to a storm, which contributes to the development of storm rotation. Mesocyclones, known tornado producers, require storm rotation in order to develop.

12. Modified Lifted Index (MLI). The MLI considers the destabilizing effects of cold air aloft, which the LI fails to take into account. It works well as a severe thunderstorm indicator in Europe, though it has been used with success in the CONUS. It gives poor results when the -20°C level is above 500 mb (too warm) or below the LCL (too cold).

13. S Index (S). The German Military Geophysical Office (GMGO) developed this index from the Total Totals (TT) index. The S Index adds the 700-mb moisture and a variable parameter based on the Vertical Totals (VT). The addition of 700-mb moisture tailors this index for sections of Europe since low-level heating is usually less intense in parts of Europe than in the States, and 700-mb moisture is a good predictor of thunderstorm development there. The S-Index is useful from April to September. It can be computed from the equation:

$$S = TT - (700T - 700T_d) - A$$

Where A is defined as follows:

- If $VT > 25$ then $A = 0$
- If $VT \geq 22$ and ≤ 25 then $A = 2$
- If $VT < 22$ then $A = 6$

14. Severe WEather Threat Index (SWEAT). The SWEAT index is designed to predict severe storms and tornadoes, rather than ordinary thunderstorms. High SWEAT values do not necessarily mean that severe weather will occur since it doesn't consider triggering mechanisms. High SWEAT values based on the morning sounding do not necessarily imply severe weather will occur. If SWEAT values remain high for the forecast sounding, then severe weather potential is high.

15. Showalter Stability Index (SSI). This index works best in the Central US with well-developed systems. This index is a first indication of instability. It doesn't work well if a frontal surface or inversion is present between 850 mb and 500 mb. It also is not a good predictor of severe weather when low-level moisture is present below 850 mb. See Fawbush-Miller or Lifted Index.

16. Storm Relative Directional Shear (SRDS). SRDS is also a SHARP-derived index, used to measure the amount of directional shear in the lower 3 km of the atmosphere, and strong directional shear significantly contributes to storm rotation.

17. Storm-Relative Helicity (S-RH). Helicity has been found to correlate strongly with the development of rotating updrafts. The correlation with tornadoes is less clear. Helicity is very sensitive to the storm motion. Storms that encounter boundaries or slow down can have radically different helicities than the general environment. A high-helicity, low-shear environment is possible.

18. Surface Cross Totals (SCT). Use SCT to predict severe potential for areas at high elevations.

19. Thompson Index (TI). Use TI to determine thunderstorm severity over or near the Rockies.

20. Total Totals (TT). Use TT to forecast thunderstorm coverage and severity. This index is particularly good with cold air aloft. It may over-forecast severe weather when sufficient low-level moisture is not available. The TT index is the sum of the Vertical Totals and Cross Totals.

21. Vertical Totals (VT). Use VT in the western U.S., UK, and western Europe to predict thunderstorm potential.

22. Wet-Bulb Zero Height (WBZ). The WBZ is often a good indicator of hail and surface gusts 50 knots or greater when it lies between 5,000 to 12,000 feet, and of tornadoes, when it lies between 7,000 to 9,000 feet. It is not a good indicator for mT air masses, which naturally have high WBZs; hail or strong surface gusts rarely occur in these air masses outside the immediate vicinity of tornadoes. Many studies indicate a strong correlation between the height of wet-bulb zero and the types of tornadoes that will occur. While it doesn't directly forecast the occurrence of tornadoes, WBZ can help predict whether tornadoes will form in families or singularly once tornadoes are forecast.

Table 3-2 lists various general thunderstorm forecast indices and threshold values; Table 3-3 lists indices and threshold values for forecasting severe weather potential. Tables 3-4 and 3-7 list various tornado indicators. Thresholds vary somewhat from site to site, so closely monitor these values to discover the best value for local use and adjust accordingly. The best way to evaluate a threshold is to keep a continuous record of their effectiveness. Regional values are given where data are available. See also Tables 3-11 to 3-14 for regional summaries.

Table 3-2. General thunderstorm (instability) indicators.

Index	Region	Weak (Low)	Moderate	Strong (High)
CAPE		300 to 1000	1000 to 2500	2500 to 5300
Cross Totals (CT)	East of Rockies	< 18 No thunderstorms	18 to 19	≥ 20
	Gulf Coast	< 16 No thunderstorms	20 to 21	
Dynamic Index	For airmass thunderstorms	Positive numbers		Negative numbers
Fawbush-Miller Index (FMI)		0 to -2	-2 to -6	-6 and lower Severe possible
GSI Index	Mediterranean	> 8 Thunderstorms		≤ 8 Thunderstorms
K-Index (KI)	East of Rockies (mT air masses), and the Tropics	20 to 26	26 to 35	> 35
	West of Rockies (mT)	15 to 21	21 to 30	> 30
KO-Index (KO)	Cool, moist climates: Europe, Pacific NW	>6	2 to 6	<2
Lifted Index (LI)		0 to -2	-3 to -5	-5 and lower
S-Index	Europe, April-September only	< 39 No thunderstorms	> 40 and < 46 Thunderstorms possible	> 46 Thunderstorms likely
Showalter Stability Index (SSI)	US	≥ +3	+2 to -2	≤ -3 Severe possible
	Europe	> 2 No thunderstorms	≤ 2 Thunderstorms possible	
Total-Totals (TT)	West of Rockies	48 to 51	52 to 54	> 54
	East of Rockies	44 to 45	46 to 48	> 48
	Europe	> 42	> 48	> 50
Vertical Totals (VT)	US: general			≥ 26
	Gulf Coast			≥ 23
	West of Rockies	< 28 No thunderstorms	28 to 32	> 32
	UK			> 22
	W. Europe			> 28

Table 3-3. Severe thunderstorm indicators.

Index	Region	Weak (Low)	Moderate	Strong (High)
Bulk Richardson Number (BRN)		> 50 Multi-cellular storms		10 to 50 Supercells
Cross Totals (CT)	East of Rockies	22 to 23	24 to 25	> 25
	Gulf Coast	16 to 21	22 to 25	> 25
	West of Rockies	< 22	22 to 25	> 25
Modified Lifted Index	Europe	0 to -2	-3 to -5	-5 and lower
Surface Cross Totals (SCT)	East of 100°W			≥ 27
	High Plains			≥ 25
	Foothills of Rockies			≥ 22
SWEAT Index	Midwest and Plains (unreliable at higher elevations)	<275	275 - 300	≥ 300
Thompson Index (TI)	Over the Rockies	20 to 29	30 to 34	≥ 35
	East of Rockies	25 to 34	35 to 39	≥ 40
Total-Totals (TT)	West of Rockies	55 to 57	58 to 60	≥ 61
	East of Rockies	48 to 49	50 to 55	≥ 56
Wet-Bulb Zero Height	Not for use with mT air masses	< 5,000 ft	7,000 to 9,000 ft	Tornadoes
			5,000 to 12,000 ft	Large hail

Table 3-4. Tornado Indicators.

Index	Value	Interpretation
Energy/Helicity Index (EHI)	0.8 to 1	Weak tornadoes.
	1 to 4	Strong tornadoes.
	> 4	Violent tornadoes.
Lifted Index (LI)	< -6	Tornadoes possible.
Mean Storm Inflow (MSI)	> 20	Mesocyclone development possible.
Showalter Index (SSI)	≤ -6	Tornadoes possible.
Storm Relative Directional Shear (SRDS)	> 70	Mesocyclone development possible
Storm Relative Helicity (s-rH)	≥ 400	Tornadoes possible.
SWEAT Index	≥ 400	Tornadoes possible.
Wet-Bulb Zero Height	7,000 to 9,000 ft (mP)	Families of tornadoes.
	≥ 11,000 ft (mT)	Single tornadoes.

B. EVALUATION AND TECHNIQUES. There are many data sources and tools available to the forecaster: atmospheric models and numerical analysis techniques; satellite, radar, and conventional upper-air data; and a variety of software applications designed to help forecasters interpret these data. Some of these programs are available on the Internet. Deciding which tools and data to use in forecasting severe convective weather can be an overwhelming task. Using the following techniques and rules of thumb may help in organizing your thoughts as you move through the forecast process. Start by knowing the typical “seasons” for thunderstorm activity in the geographical area of interest as described in Regional Climatologies produced by AFCCC.

1. Synoptic Evaluation for Potential Severe Weather. Begin by determining if the current and/or forecast weather is favorable for severe convective weather pattern development. After initializing available numerical weather prediction model outputs (i.e., MM5, NGM, ETA, NOGAPS, BKFG, etc.), examine the graphical representations of the NWP model outputs to determine which model has the best handle on the current synoptic weather pattern.

Use examples of the classic convective patterns described later in this section to determine which, if any, apply to the current weather pattern (regime). If there is a match, apply information regarding storm characteristics, triggers, timing, and outbreak areas to the forecast. Table 3-5 suggest products and features to look for in developing a forecast for severe convective weather. Notice that jets, shears, moisture gradients, and dry-air intrusions are key features on these products.

Pay close attention to areas where favorable severe convective storm predictors stack with height. The more favorable conditions in a specific area, the greater the chance of development of severe thunderstorms.

Use composite products to help stack significant features. If most of the predictors indicate a “strong” potential for severe weather, then seriously consider forecasting severe thunderstorms, tornadoes, strong winds, and/or hail. If predictors mostly indicate “weak,” consider forecasting non-severe

thunderstorms. If indicators are mixed, consider forecasting non-severe thunderstorms with isolated or scattered severe thunderstorms. Finally, if low-level predictors are strong, weak upper-level diffluence is often sufficient to trigger severe weather, and if low-level predictors are marginal, strong upper-level diffluence is necessary to trigger severe convective storms.

Incorporate local rules of thumb, the Military Weather Advisory, forecast discussion bulletins, and the various stability indices appropriate for the location into the decision-making process. It is seldom wise to base a forecast on a single tool when several are available.

2. Forecast Products and Techniques. Begin with a Skew-T diagram of the nearest representative upper-air sounding to the location of interest. Use the techniques described to analyze the sounding for indications of convective instability in the air mass. There are many good Skew-T software programs available (SHARP, RAOB, Skew-T Pro, etc.), to help with this analysis. Determine if the air mass is absolutely unstable or, more commonly, conditionally unstable.

Next analyze the upper-air and surface products for the area of interest (Table 3-5). Upper-air analyses are not as useful for forecasting air-mass thunderstorms as they are for forecasting the classic trackable severe thunderstorms previously discussed, but they can often help. The LAWG will play a key role in an analysis since it can be updated hourly and the significant triggering mechanisms are often apparent on these products. Table 3-6 identifies key predictors to analyze and why they are significant.

3. Identifying Severe Weather Features.

a. Tornado Features. The first requirement to predict tornadoes is a forecast for severe thunderstorms, and then to determine whether tornadogenesis will occur. Research has shown the strength or magnitude of various parameters derived from the low-level wind and thermodynamic fields of the atmosphere are keys to tornadogenesis. The elements that contribute to tornadogenesis are strong storm-relative flow, strong vertical wind shear, strong low-level vorticity (i.e., strong low-level

Table 3-5. Product analysis matrix and reasoning.

Charts	Feature to Analyze	Why (favorable/unfavorable; weak, moderate, strong chance for severe weather conditions.)	
200 mb/300 mb	Identify jet maximums.	• ≤55 knots Weak	
		• 56 to 85 knots Moderate	
		• ≥ 86 knots Strong	
	Streamline and identify diffluent areas.	Favorable for development.	
	Shade areas of horizontal wind speed shear.	Favorable for development.	
500 mb	Identify jet maximums.	• ≤ 35 kt Weak	
		• 36 to 49 Moderate	
		• ≥ 50 Strong	
		Streamline and identify diffluent areas.	Favorable for development.
	Shade areas of horizontal wind speed shear.	• ≤ 15 kt Weak	
		• 16 to 29 kt Moderate	
		• ≥ 30 kt Strong	
	Isopleth 12-hour height falls (Oct to Apr) or 24-hour height falls (May to Sep).	• ≤ 30 m Weak	
		• 31 to 60 m Moderate	
		• ≥ 61 m Strong	
	Perform 2°C isotherm analysis, color cold pools, identify thermal ridges and troughs.	Severe activity suppressed near and east of thermal ridge particularly when in phase with streamline ridge.	
	Identify areas of cold air advection.	The following temperatures are favorable:	
		• Dec to Feb: -16°C or lower.	
		• Mar, Apr, Oct, Nov: -14°C or lower.	
• May, Jun: -12°C or lower.			
	• Jul to Sep: -10°C or lower.		
Identify dew-point depressions of 6°C or less, moisture analysis.	Cut-off moisture sources indicate a short wave is present.		
Identify areas of vorticity advection.	NVA: Weak Or Not Favorable.		
	Positive Vorticity isopleths crossing 500-mb height contours:		
	• ≤ 30° Moderate		
	• > 30° Strong		
	Storms develop on the periphery of the vorticity maximum and not directly below.		
700 mb	Perform 2° isotherm analysis, identify thermal troughs and ridges.	Good stacking of cold air here and at 500 mb is favorable for severe.	
	Indicate (12-hour) temperature no-change line.	Advancement of the temp. no-change line ahead of the 700-mb trough indicates the surface low will intensify.	
	Draw dew-point depression lines.	Moisture fields detached from the main moisture field indicate rising motions and a possible short wave in the area.	
	Mark dry line. The dry line can be placed where dew point is ≤ 0°C, the dew point depression is ≥ 7°C, or the RH is ≤ 50 percent.	Weak winds across the dry line: Weak	
		Winds 15 to 25 knots crossing between 10° and 40°: Moderate	
		Winds ≥ 26 knots crossing between 41° and 90°: Strong	
Streamline and identify confluent areas.	Confluent areas are favorable for severe.		

Table 3-5. (cont) Product analysis matrix and reasoning

Charts	Feature to Analyze	Why (favorable/unfavorable; weak, moderate, strong chance for severe weather conditions).
850 mb	Streamline and identify confluent zones.	The greater the angle of winds from dry to moist air, the more unstable.
	Identify wind speed maximums.	<ul style="list-style-type: none"> • \leq 20 knots Weak • 21 to 34 knots Moderate • \geq 35 knots Strong
	Draw every 2°C isotherm starting with an isotherm that bisects the entire U.S. Mark thermal ridges.	Thermal ridge is often ahead of convergence zone. Cold air advection often found behind the main convergence zone, unless a dry line forms and moves out ahead of the cold advection. (Warm air is usually ahead of the main convergence zone).
	Draw isodrosotherms every 2°C starting at 6°C (43°F).	Dew point: <ul style="list-style-type: none"> • $<$ 8°C (46°F) Weak • 9°C to 12°C (48 to 54°C) Moderate • \geq 13°C (55°F) Strong
	Color in areas of significant moisture.	A diffuse moisture field is unfavorable for development of severe weather. Thermal ridge east of moisture axis: Weak Thermal ridge coincident with the moisture axis: Moderate Thermal ridge west of the moisture axis: Strong
	Identify dry line.	Note the angle of winds crossing from dry to moist air, the greater the angle, the greater the instability. Where the dry line is intruding into moist areas is unstable.
Surface	2-mb isobar analysis	Surface pressure patterns indicate likely areas for severe weather: <ul style="list-style-type: none"> • $>$ 1009 mb Weak • 1009 to 1005 mb Moderate • $<$ 1005 Strong
	Isalobaric analysis (12-hour) identify areas of falling pressure.	Squall lines often develop in narrow troughs of falling pressure. A strong pressure rise/fall couplet is favorable for severe weather. The following values indicate probability of severe weather: <ul style="list-style-type: none"> • \leq 1 mb Weak • 2 to 5 mb Moderate • $>$ 6 mb Strong
	Identify areas of rapid temperature and dew point change	Favorable for development of severe weather
	2° isodrosotherm analysis starting at 50°F (10°C).	Areas of horizontal moisture convergence are favorable. The following dew point temperatures indicate probability of severe weather: <ul style="list-style-type: none"> • \leq 50°F (10°C) Severe Unlikely • $>$ 51 to 55°F (11 to 12°C) Weak • $>$ 56 to 64°F (13 to 17°C) Moderate • $>$ 65°F (18°C) Strong
	Identify confluent streamline areas.	Areas of strong winds converging with weak winds is favorable.
	Identify highs, lows, fronts, squall lines, and dry lines and mark their previous locations.	Any discontinuity line is a likely place for thunderstorm development. Intersecting discontinuity lines are highly probable locations for development. Use distance between past and current locations to extrapolate onset of thunderstorms.
1000/500 mb Thickness	Mark thickness ridge.	Probable area for squall line.
	Mark thickness no-chance line (12-hour).	Indicates area of cold advection.

Table 3-6. Identifying features of airmass thunderstorm development on upper-air charts.

Product	Feature to Analyze	Why (favorable/unfavorable for convective weather conditions.)
200 mb/300 mb	Streamline	Areas under diffluent flow aloft are favorable for thunderstorms; convergence strongly suppresses development.
500 mb	Ridge placement	Convection forms on the confluent side of the ridge axis.
	Vorticity advection	PVA is present, severe weather is possible. NVA or neutral, severe weather unlikely
	Short-wave troughs	Severe weather possible.
850 mb/925 mb	Streamline	Confluence.
	Gradient Winds	Use to forecast steering flow if stronger than forecast sea breeze.
Surface/LAWC	Streamline: Draw convergent asymptotes	Expect convection to begin along these lines when convective temperature is reached.
Composite Workchart	Satellite depiction Radar observations LAWC: streamlines	Identify cells/lines of convection. Identify intersecting boundaries as possible areas for severe winds, heavy rain, and possible hail.
	Mark past positions of significant features.	Use the time difference and distance between related weather features to forecast their future movement, and to forecast areas of intersecting boundaries and development.

cyclonic circulation), potential for strong rotating updrafts, and great instability or buoyancy. All of these elements are associated with supercells, which are known tornado producers. However, not all tornado-producing thunderstorms are supercells.

Several tools are available for determining whether conditions exist for tornadogenesis. These are shown in Table 3-7 with the parameters they measure, and what each tool is used to predict. The actual threshold values are listed in Tables 3-2 through 3-4.

Note that several of these tools indicate storm type rather than just tornado type or strength. Knowing the expected storm type can indicate where tornadoes are likely to form within the storm, aiding severe storm metwatch: Combine storm-type knowledge with the WSR-88D’s meso indicator (and other features), track and forecast movement of potentially tornadic storms and radar signatures. Listed below are descriptions of likely locations where supercell and non-supercell tornadoes are found in a storm.

Table 3-7. Tornado forecasting tools.

Tool	Parameter(s) Measured	Indicator for:
Bulk Richardson Number (BRN).	Buoyancy and wind shear.	Storm type: multicell, supercell.
Convective Available Potential Energy (CAPE).	Buoyancy.	Potential updraft strength, which relates to storm intensity.
Energy/Helicity Index (EHI).	Combines CAPE and SRH.	Tornadoes.
Mean Storm Inflow (MSI).	Storm relative winds.	Mesocyclone development.
Storm Relative Directional Shear (SRDS).	Low-level vorticity (i.e., strong low-level cyclonic circulation).	Mesocyclone development.
Storm Relative Helicity (SRH).	Potential for a rotating updraft, horizontal vorticity due to wind shear.	Supercells and tornadoes.
Hodographs.	Vertical and horizontal directional and speed shear, mean wind, storm motion, storm inflow, helicity.	Storm type: single cell, multicell, and supercell.

(1) *Supercell Tornadoes.* These tornadoes develop in the mesocyclone of classic and heavy precipitation supercells, and on the leading edge of the storm updraft in the vicinity of the wall cloud of low-precipitation supercells.

(2) *Non-super-cell Tornadoes.* They can occur in the flanking line of a supercell, during the growth stage in the updraft of “pulse” thunderstorms (strong, single-cell storms), along the gust front of multicellular storms, and in strong updraft centers of multicellular storms. Tornadoes in single-cell and multicellular storms are rare, and require exceptionally strong development of those storms to produce a tornado.

b. Bow Echo Features. The bow echo is a line of storms that accelerates ahead of the main line of storms. The bow echo forms from strong thunderstorms with a gust front. A strong downburst develops and the line echo wave pattern (LEWP) begins to “bow.” A well-developed bow echo or “spear head” is associated with the mature stage of the downburst. Strong winds and tornadoes are possible near the bow.

As the downburst weakens, the line forms a comma shape often with a mesocyclone developing on the north end of the comma which will be evident by a “hook” in the radar echo. At this point, tornadoes may still occur in the area of the mesocyclone, but the winds are now decreasing. Figure 3-13 shows the evolution of the bow echo in a LEWP. Strong to severe straight-line winds are likely to exist if four specific characteristics of the bow echo are present (see Figure 3-14).

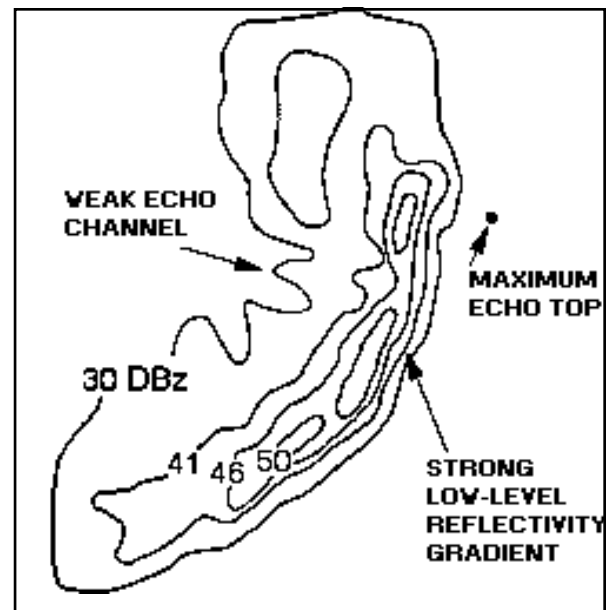

Figure 3-14. Bow Echo. Strong winds and tornadoes are possible near the bow.

- Weak echo channels exist.
- The low-level echo configuration is concave downstream (bowed).
- A strong reflectivity gradient along the leading edge of the concave-shaped echo.
- The maximum echo top is over or ahead of the strong low-level reflectivity gradient.

c. Wet Microburst Features. Microbursts or downbursts are difficult to predict and detect due to their small spatial scale (less than 4-km diameter), shallow vertical extent and short life span. However,

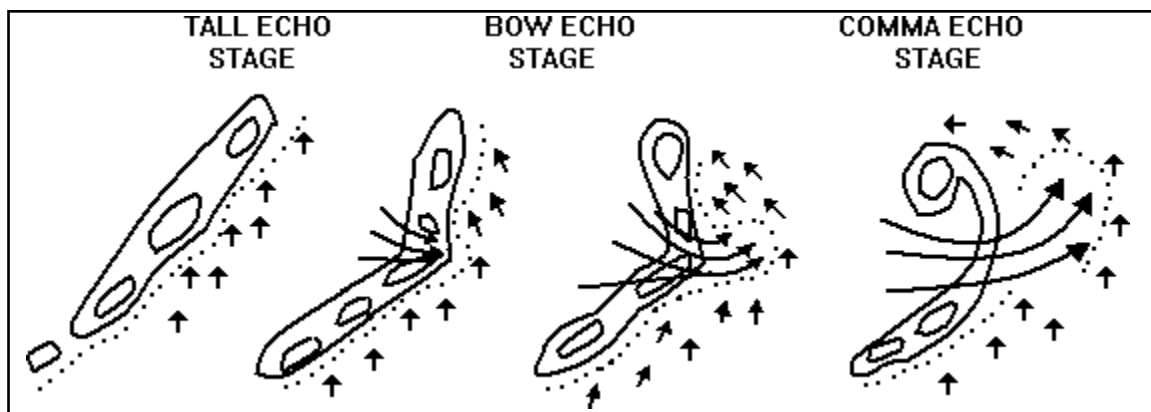

Figure 3-13. Line Echo Wave Pattern, Bow Echo Evolution. Strong to severe straight-line winds are likely to exist.

the following technique can provide up to 40 minutes lead time predicting maximum downburst winds from pulse-type thunderstorms. The following conditions must exist:

- A source of dry (dew-point depression $\geq 18^{\circ}\text{C}$), potentially cold air between 400 and 500 mb.
- Maximum Reflectivity at least 55 dBZ (sufficient moisture for entrainment of the parcel to produce negative buoyancy through evaporative cooling).

To predict the wind gust potential:

- Interrogate the suspect storm cells on the WSR-88D.
- Obtain the maximum top of the cell using Echo Tops and get the VIL.
- Cross-reference the two values using Table 3-8, and read the maximum downburst winds, in knots, in the body of the table.

For the Southern Plains, Southeast, and Gulf Coast, add 1/3 of the mean low-level wind speed to the value in the table to predict the wind gust from the

potential microburst. For the Northeast, add mean low-level wind speed to the value given in the table.

Note This technique will not work when VIL values are large due to hail contamination. When thunderstorms are too close to the radar, echo top estimates are erroneously low. This technique also works poorly for thunderstorms over 125 NM away from the radar. This only works for pulse-type air-mass thunderstorms, it does not work for multicell and supercell storms.

d. Boundaries and Boundary Interaction Features.

(1) *Satellite.* As diurnal heating occurs, cumulus clouds will often form into cloud streets (over land) oriented with the gradient wind flow. Look for clear areas forming in the flow; these identify sea-breeze fronts, lake breezes, and outflow boundaries. The leading edge of these boundaries between clear areas and the cloud streets is highly favorable for development. Similarly, the boundary between cloud-free areas and fog-stratus broken/overcast areas are prime for development as clouds burn off. When outflow boundaries intersect, convection is almost guaranteed if the air mass is unstable or conditionally unstable.

Table 3-8. Wet microburst potential table. Determine VIL and maximum cell tops (100s feet) from WSR-88D, to read maximum downburst winds (knots) in body of table.

		T O P S									
		250	300	350	400	450	500	550	600	650	700
V I L	35	45	42	37	31	23					
	40	49	46	42	38	30	19				
	45	53	50	47	42	36	28	14			
	50	57	55	51	46	41	34	24			
	55	60	57	54	50	45	39	31	18		
	60	63	61	57	54	50	44	37	27		
	65	66	64	61	58	53	48	42	33	21	
	70	69	67	64	61	57	53	46	39	29	
	75	72	70	67	64	60	56	50	44	35	22
	80	75	72	70	67	63	59	54	48	40	29

(2) *Radar - WSR-88D.* Sea-breeze boundaries and other discontinuities in low-level flow can usually be identified in the WSR-88D base reflectivity displays. The sea breeze will appear as a thin line of low intensity returns parallel to the coastline. These patterns can be entirely obliterated if lower intensity values are masked for clutter suppression. Convection is most likely to form on these lines when convective temperature is reached.

(3) *Streamline Analysis/Sea Breeze Onset.* Use the latest LAWC streamline analysis combined with current satellite and radar analysis. Create a composite product (or use the LAWC) to identify locations of streamline-confluent asymptotes, sea/lake breezes, and outflow boundaries. Mark past placements of these boundaries. Determine speed and direction of movement of boundaries to project when and where these boundaries will intersect. The intersections are almost certain to result in air-mass thunderstorms. If thunderstorms are present along the boundaries already, severe weather (usually severe wind gusts) is possible. Tornadoes and hail are unlikely unless strong upper-level support is evident.

(4) *MWA Products.* These centrally produced products cover large forecast areas and periods of time. Although they are not site-specific forecasts, they are products of an extensive evaluation of observed and forecast weather conditions. They should be carefully considered in the preparation of site-specific thunderstorm forecasts. They should not be used as the sole decision aid in preparing the forecast.

4. Techniques

a. Severe Thunderstorm Checklist. The parameters involved in producing ordinary versus severe thunderstorms are well documented. However, no two thunderstorm situations are alike. There are varying degrees of intensity for each parameter, and the combinations of parameters produce individual storm events. This makes a foolproof, all-inclusive checklist nearly impossible. The following checklist is an outline of the forecast-reasoning process. Incorporate local rules of thumb and stability thresholds to fine-tune this for each station.

Step 1. Identify the current weather regime.

- Dryline.
- Frontal.
- Overrunning.
- Cold Core.
- Squall Line.
- Air-mass Thunderstorm.

Step 2. Analyze available NWP models. Tailor the analysis.

Step 3. Are elements for severe weather present? Refer to Table 3-5 for features conducive severe weather.

Step 4. Analyze current and forecast Skew-Ts and calculate stability indices appropriate for the weather pattern and station. Do they indicate severe weather potential? See Tables 3-6 and 3-7.

Step 5. Produce and examine the current and forecast hodograph from current and forecast sounding data. What type of storms can be expected?

Step 6. What type of severe weather: tornadoes, convective winds, or hail? Severe weather forecasting aids follow.

b. Forecasting Convective Wind Gusts. This section presents four methods to forecast convective wind gusts. Each is designed to forecast winds under different conditions: Use the T1 method for scattered thunderstorms in the vicinity of the forecast location; T2 winds are designed for intense squall lines or numerous thunderstorms; the next method is for high-based thunderstorms; and the Snyder Method is for air-mass or pulse thunderstorms. Each of these methods requires a current sounding or forecast Skew-T.

(1) *T1 Gust Computation.* There are two methods of computing the T1 gust, one for when an inversion is present, the other for no inversion.

Table 3-9. T1 convective gust potential.

T1 values (°C)	Average Gust Speed (knots)	T1 values (°C)	Average Gust Speed (knots)
3	17	15	49
4	20	16	51
5	23	17	53
6	26	18	55
7	29	19	57
8	32	20	58
9	35	21	60
10	37	22	61
11	39	23	63
12	41	24	64
13	45	25	65
14	47		

(a) *T1 Method 1.* The top of the inversion present is within 150 mb to 200 mb of the surface and is not susceptible to being broken by surface heating.

- Project moist adiabat from warmest point of inversion to 600 mb.
- Calculate temperature difference (°C) between the moist adiabat and the dry-bulb temperature trace at 600 mb (label as T1).
- Refer to Table 3-9. The value found for T1 is considered to be the average gust speed.
- Add 1/3 of lower 5,000 feet mean wind speed to chart value for maximum gust speed.
- Wind gust direction is determined from mean wind direction in layers between 10,000 feet and 14,000 feet above local terrain.

(b) *T1 Method 2.* No inversion present or inversion is relatively high (more than 200 mb above surface).

- Forecast maximum surface temperature.
- Project moist adiabat from maximum temperature to 600 mb.

- Calculate the difference between the moist adiabat and dry-bulb temperature trace at 600 mb and label as T1.

- Refer to Table 64. The value found for T1 is considered to be the average gust speed.
- Add 1/3 of lower 5,000 feet mean wind speed to chart value for maximum gust speed.
- Wind gust direction is determined from mean wind direction in layers between 10,000 and 14,000 feet above local terrain.

(2) *T2 Gust Computation.*

Step 1. Find the wet-bulb zero (where wet-bulb curve crosses the 0°C isotherm).

Step 2. Project the moist adiabat through wet-bulb zero to the surface.

Step 3. Read value of temperature (°C).

Step 4. Subtract the moist adiabat temperature (°C) from surface dry-bulb (°C) (or projected maximum) temperature.

Step 5. Label as T2.

Step 6. Refer to Figure 3-15. Follow the T2 to where it intersects the three curves. The first

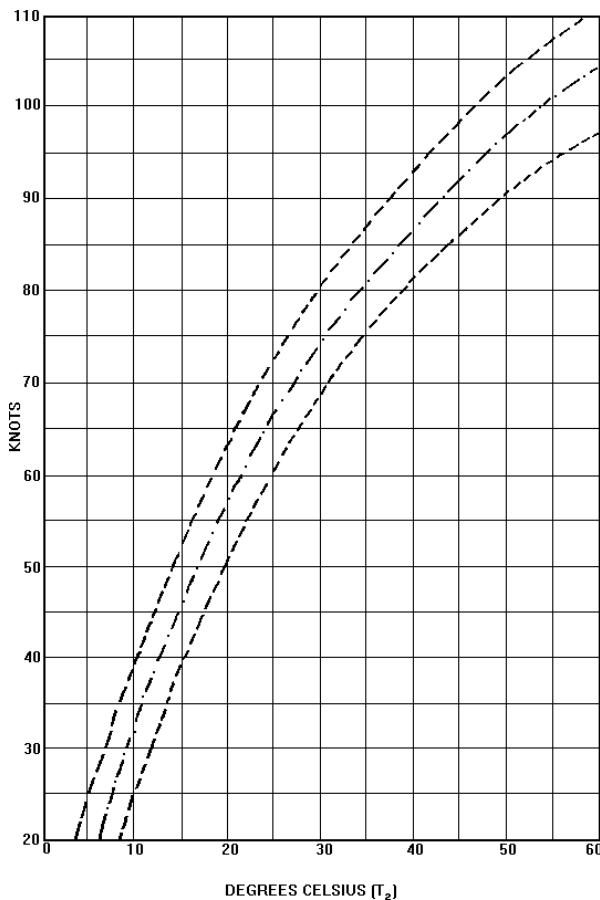

Figure 3-15. T2 Gust Computation Chart. See Step 6.

intersection point represents the minimum gust in knots; the middle intersection point represents the average gust; and the upper intersection point represents the maximum gust.

Step 7. The mean wind direction in the layer between 10,000 and 14,000 feet has been found to closely approximate direction of maximum gusts at surface and should be used in forecasting gust direction.

(3) *High-based Thunderstorm Method.* This method was developed for use near the Rocky Mountains to determine the potential for wind gusts reaching the surface, produced by high-based thunderstorms (typically 17,000 to 18,000 feet MSL). This method can be adapted for other mountainous regions as long as the atmosphere above 12,000 feet is convectively unstable and low levels are dry.

Step 1. Multiply 500-mb dew-point

depression by three and subtract 700-mb dew-point depression from the result. If number is negative, proceed; if number is positive, gust potential is zero.

Step 2. Compute upper-level instability index (UI) by lifting a parcel from 500 mb to its LCL, then up moist adiabat through 400 mb to 300 mb. At the point where the moist adiabat crosses 300 mb and 400 mb, read the temperature and use the following formula:

$$UI = (T_{400} - T_{500}) + (T_{300} - T_{500})$$

where: T_{300} is the temperature at which the moist adiabat crosses the 300 mb level. T_{400} is similar, at the 400 mb level. T_{500} is temperature of sounding at 500 mb level.

Step 3. Using Figure 3-16, plot the result of Step 1 and 2. If the point falls within:

Area 1. Conditions are too moist for strong convective gusts, even though thunderstorms may occur.

Area 2. Conditions are too stable for upper-level thunderstorms.

Area 3. The potential exists for gusts greater than 30 knots for period during which thunderstorms are expected.

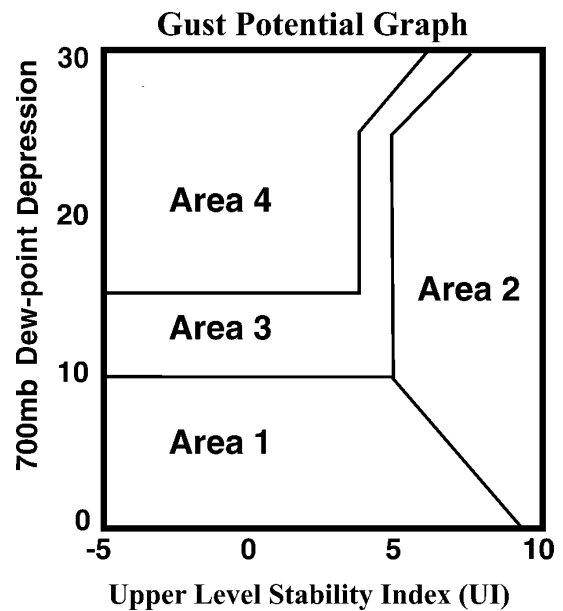

Figure 3-16. Gust Potential Graph. Plot the result of Step 1 and 2.

Area 4. The potential exists for gusts greater than 40 knots for period during which thunderstorms are expected.

(4) *Snyder Method.* A method of forecasting the average gust with air-mass thunderstorm.

Step 1. Plot the latest rawinsonde, plot the wet-bulb curve, and locate the height of wet-bulb zero (SHARP is good for this). _____

Step 2. Forecast max temperature (°F) at time of thunderstorm occurrence _____

Step 3. Lower the WBZ value to the surface, moist adiabatically, to calculate the “Down Rush Temperature (°F).” - _____

Step 4. Step 2 - Step 3. _____

Step 5. Find the average wind speed in the layer 5,000 feet above and below the WBZ. + _____

Step 6. Average gust associated with air-mass thunderstorms. Ignoring units, add Step 4 + Step 5. _____ knots

(5) *Derecho Checklist.* The derecho resembles the Line Echo Wave Pattern (LEWP) and/or a large bow echo. Storm movement can exceed 50 knots and move slightly to the right of the mean wind. They last for several hours, continually maintaining high wind speeds and gusts, and traverse hundreds of miles. The following parameters are necessary for derecho development. Without all of these elements present, derechos are unlikely.

- Surface-based Lifted Index (SBLI) \leq -6.
- Warm air advection at 850 mb and 700 mb.
- Quasi-stationary boundary parallel to 500-mb flow.
- Maximum 500-mb 12-hour height-falls \geq 60 meters.
- Estimated mean wind speed from 8,000 to 18,000 feet \geq 25 knots.

- Mean relative humidity from 700 mb to 500 mb less than 70 percent.

- 500-mb flow direction from west to northwest (most frequent with wind direction 240° to 280°).

Finally, if these parameters exist over a 250 NM (or greater) swath downstream of the MCS, then any rapid-moving squall lines or squall line segments moving with the mean flow of 35 knots or greater are likely to develop into a derecho. If these conditions do not persist downstream for 250 NM, locally strong or severe winds are still possible in lines of downburst clusters, or bow echoes.

c. Forecasting Hail and Hail Size. Hail is a micro-scale phenomenon associated with all thunderstorms. The key is to determine if the hail within a thunderstorm will occur at the surface, and then determine the hailstone size.

(1) *Forecasting Hail (Using Skew-T).* The following is an objective method derived from a study of severe Midwest thunderstorms. This method determines the cloud depth ratio, then correlates cloud depth ratio and freezing level to occurrence or non-occurrence of hail.

Step 1. From a Skew-T, calculate the Convective Condensation Level (CCL), Equilibrium Level (EL), and Freezing Level (FL).

Step 2. Determine cloud-depth ratio:

$$\frac{(CCL - FL)}{(CCL - EL)}$$

Step 3. Cross-reference the cloud-depth ratio (y-axis) to the freezing level (x-axis) on Figure 3-17. If the plot is below the line, forecast hail; if above the line, do not forecast hail.

(2) *Forecasting Hail Size (Using Skew-T).* The following technique requires a sounding plotted on a Skew-T chart. The calculations are accomplished graphically, either on the Skew-T or on the accompanying charts (Figures 3-18 to 3-20).

Step 1. Determine the convective condensation level (CCL), which is found using the mean mixing ratio in the lowest 150 mb, then follow

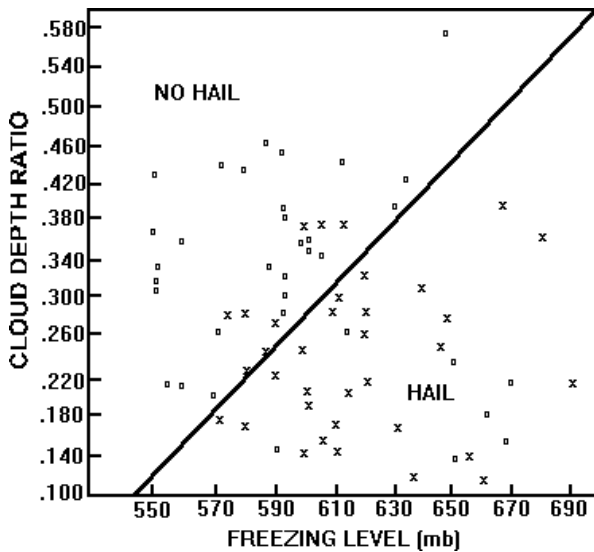

Figure 3-17. Hail Prediction Chart. See text. Also shown are the results of the original study.

the saturation mixing-ratio line to its intersection with the temperature trace, Point A (see Figure 3-18).

Step 2. Point B_H is at the intersection of the -5°C isotherm and the sounding.

Step 3. From Point A go moist adiabatically to the pressure at B_H , this is Point B' .

Step 4. Note the temperature difference ($^\circ\text{C}$) between B_H and B' . It is used with the horizontal axis in Figure 3-19.

Step 5. Go from B_H dry adiabatically to the CCL; this is Point H' . The temperature difference between B_H and H' is used with the vertical axis in Figure 3-19.

Step 6. Forecast preliminary hail size from Figure 3-19. The dashed lines on Figure 3-19 represent hailstone diameter in inches.

Step 7. Use the following procedures to find the wet-bulb-zero height.

- Choose a reported level close to the freezing level. From the dew point at that level, draw a line upward parallel to a saturation mixing-ratio line.

- From the temperature at the same level,

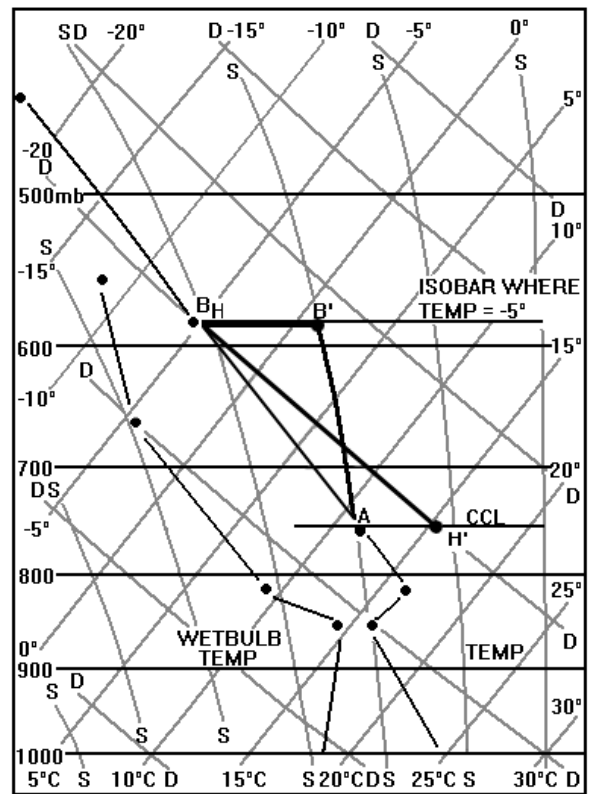

Figure 3-18. Skew-T Chart. Curves labeled “S” are saturation adiabats; lines labeled “D” are dry adiabats. Other points are described in the text.

draw a line upward parallel to a dry adiabat until it intersects the line drawn in previous step.

- From this intersection, follow a saturation adiabat back to the original pressure. This is the wet-bulb temperature ($^\circ\text{C}$).

- Repeat the above steps as necessary; connect the various wet-bulb temperatures to form a trace.

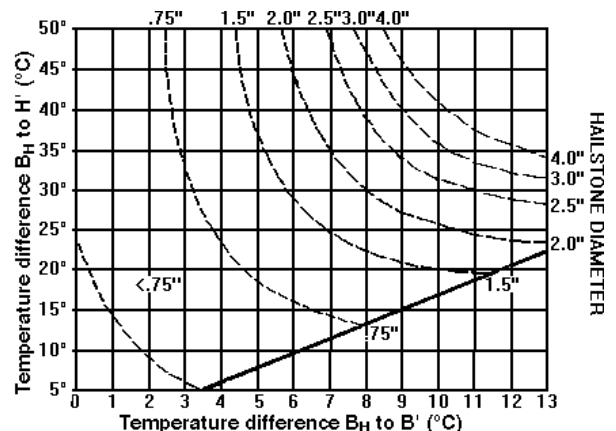

Figure 3-19. Preliminary hail size nomogram.

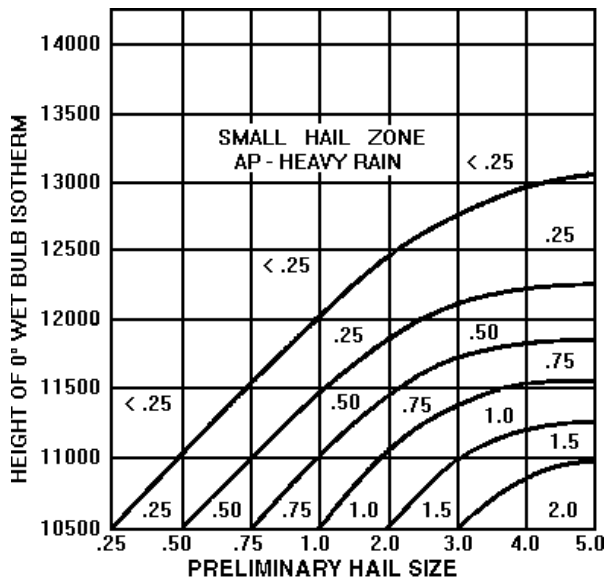

Figure 3-20. Final Hail Size Nomogram. If the wet-bulb-zero height is greater than 10,500 feet, enter this figure with the preliminary hail size and the height of the wet-bulb-zero to compute final hail size.

- Wet-bulb-zero height is the height at which the wet-bulb trace crosses the 0°C isotherm.

Step 8. If the wet-bulb-zero height is less than 10,500 feet, the preliminary hail size computed in Step 6 will be the final size. If the wet-bulb-zero height is greater than 10,500 feet, enter Figure 3-20 with the preliminary hail size and the height of the wet-bulb-zero to compute final hail size.

(3) *Forecasting Hail Size Using VIL Density.* Use the WSR-88D to approximate hail size from active storms using Table 3-10.

5. General Rules of Thumb.

a. Onset of Typical Thunderstorms. Predict thunderstorm onset at the time when convective temperature is needed or maximum solar insolation is expected. Predict formation along confluent streamline asymptotes and discontinuities in the flow such as sea breezes, outflow boundaries, and lake breezes.

b. Severe Thunderstorms. Hail, tornadoes, and severe winds are less common with air-mass thunderstorms. For severe storms to occur, at least one of the following must be present:

Table 3-10. VIL density versus hail size.

VIL Density	Hail Size
≥ 3.5 g/m ³	≥ ¾ inch
≥ 4.0	≥ 1 inch
≥ 4.3	≥ Golf ball size

- Cold and/or dry air aloft.
- Positive Vorticity Advection.
- Shortwave troughs at 500 mb.

Note: Low-level convergence is necessary for severe weather.

6. Regional Rules of Thumb.

a. Convective Weather: Alaska. Use the following rules of thumb to aid in forecasting convective weather in Alaska.

- Use critical values for stability indices in Table 3-11 to help base thunderstorm forecasts.
- The temperature at the top of air-mass thunderstorms should be below -28°C to produce lightning.
- Do not forecast air-mass thunderstorms (thunderstorms not directly associated with a front) if the wind at 500 mb exceeds 20 knots. Strong winds at 500 mb, in air masses not associated with fronts, tend to shear cloud tops of developing air-mass thunderstorms before they produce lightning.
- Thunderstorms over Alaska develop along trough lines (90 percent of the time), which coincide with lines of “thermal convergence” on the surface analysis. Though thunderstorms are often shallow on the early 1500Z surface analysis, these trough

Table 3-11. Stability indices for Alaska.

INDEX	CRITICAL VALUE
KI	≥ 20
VT	30.0 after 15 May 29.0 after 1 Jun 27.0 after 15 Jun 26.5 after 1 Jul 26.0 after 15 Jul 27.0 after 15 Aug 28.0 after 1 Sep

lines can often be detected by analyzing the product with 2-mb spacing.

b. Convective Weather: Europe and Eastern Mediterranean. Because of the diversity of climates found in this region (only a few of which compare to those in the U.S.), the standard methods used to forecast thunderstorms in the U.S. need to be modified to be effective in convective weather forecasting in this region.

For example, although a typical Midwestern thunderstorm is over 30,000 feet tall, in the United Kingdom (UK), thunder can come from a 12,000-foot high convective cell, and hail frequently falls from rain showers (TCU/CU) in the UK. Nevertheless, several useful forecasting methods, stability indices, and rules of thumb have been developed to assist in forecasting convective weather for Europe and the Mediterranean.

For European locations north of 40°N, spring and summer is the favored thunderstorm season. The lack of thunderstorm activity here during the colder months of the year is primarily due to lack of solar insolation. The central part of the Commonwealth of Independent States (CIS) and eastern Europe experience most convective activity in the spring. Increased solar heating of the landmass and fronts that still frequent the region causes this. Locations in North Africa appear to have a relatively “flat”

annual distribution of thunderstorm activity. The Mediterranean and eastern Turkey have two maxima, one in spring and another in fall. In the southeast Mediterranean, the thunderstorm season occurs from fall through spring when polar and arctic air passes over the warm Mediterranean waters.

(1) Modified Stability Indices. The most successful stability indices for Europe are summarized in Table 3-12. The KO Index is generally considered the most effective—it was designed specifically for Europe. It has advantage over the other two because it considers data below 5,000 feet, and it includes moisture at all levels. Other stability indices as they pertain to Europe and the eastern Mediterranean are described below.

(a) Showalter Stability Index (SSI). Though it does not reflect all anomalies below 850 mb, it has a high success rate.

(b) Total Totals (TT) Index. Used widely in both the US and Europe, it is available to forecasters via trajectory forecast bulletins. Since it fails to consider low-level moisture, it tends to under-forecast convection in Europe.

(c) Gollehon Stability Index (GSI). This index was developed specifically for use in the Mediterranean, and has proven reliable.

Table 3-12. Summary of stability indices for Europe.

INDEX	REGION	CRITICAL VALUE	
KO	Europe	> 6	No Thunderstorms
		2 to 6	Thunderstorms Possible
		< 2	Severe Thunderstorms Possible
SSI	Europe	< 2	Thunderstorms
TT	Europe	> 42	Thunderstorms Possible
		> 48	Thunderstorms Vicinity
		> 50	Thunderstorms in TAF
GSI	Mediterranean	≤ 8	Thunderstorms
		> 8	No Thunderstorms
S	Europe, April-September only	< 39	No Thunderstorms (89 percent)
		41 to 45	Thunderstorms Possible (42 percent)
		> 46	Thunderstorms Likely (75 percent)
Wet-bulb Potential Temperature at 850 mb	Europe, spring and summer	≥ 16°C	Strong chance Thunderstorms

Table 3-13. GMGO thunderstorm severity chart. Enter table with cloud-top temperature (A) and/or extent of cloud above freezing level (B); read across to predict severity. Use less severe condition if the table parameters disagree.

A. Cloud-Top Temp (°C)	B. Extent Above Freezing Level (1000 ft)	Event (Old AIRWAYS Code)	Precip (mm)	Visibility Rain (km)	Visibility Snow (km)	Hail (cm)	Peak Gust (kt)
-10 to -15	5 to 7	RW-	< 1	> 8	3 to 6		< 20
-15 to -20	7 to 9	RW	1 to 2	6 to 8	1 to 3		20 to 25
-20 to -25	9 to 12	RW+	2 to 3	4 to 6	0.5 to 1		25 to 30
-25 to -35	12 to 17	TRW-	3 to 5	3 to 4	< 0.5		30 to 35
-35 to -45	17 to 22	TRW	5 to 10	2 to 3		< 1	35 to 45
-45 to -55	22 to 27	TRW+	10 to 30	1 to 2		1 to 4	45 to 60
-55 to -70	27 to 35	TRW++	30 to 100	< 1		4 to 10	60 to 100

(d) *S Index (S)*. Created by the German Military Geophysical Office (GMGO), it's a variation of the Total Totals (TT) index.

(e) *Wet-bulb Potential Temperature at 850-mb*. Threshold values that have worked for Europe are listed. A study by Bradbury of the UK Met Office indicates that the wet-bulb potential temperature value at 850 mb of 16°C or higher is a strong indicator of thunderstorms in Europe (spring and summer).

(2) *Severe Thunderstorms*. In the Mediterranean region, techniques in AWS-TR 200, *Notes on Analysis and Severe-storm Forecasting Procedures of the AFGWC*, work well. Anywhere else in Europe, they over-forecast thunderstorms.

The GMGO developed a technique based on the vertical extent of convective clouds and the height of the freezing level (Table 3-13). This technique works very well in the predominantly maritime air masses north of the Alps. The following provides a relatively simple, reasonably accurate, consistent method for forecasting thunderstorm severity in this European region.

- Begin with a sounding. RAREPs, PIREPs, and the MWA are additional sources.
- Find the cloud-top temperature and the extent of cloud above the freezing level.
- Move across Table 3-13 to derive the most probable condition that will occur.

Note: The result is the worst case. Use the less severe of “A” or “B” if there is a discrepancy.

(a) *Rules of Thumb.*

1. Central Europe. Easterly flow isn't always dry in central Europe. Persistent low-level flow from the east/southeast often brings low-level moisture from the Mediterranean. Surface dew points and 850-mb and/or 925-mb products should be watched carefully for increasing moisture moving in from the east/southeast.

2. North and Central Europe. Spring and summertime severe thunderstorms in central and northern Europe are frequently associated with above-normal surface temperatures.

c. Convective Weather: Korea. Triggers for thunderstorms include orographic lift, frontal lift, and/or surface heating. Refer to Table 3-14 for stability indices considered critical for thunderstorm formation in Korea. Below are some of the necessary parameters needed for convective weather in Korea.

- Significant diffluence aloft.
- Abundant low-level moisture.
- Cold air advection at 500 mb.
- 500-mb temperature of -20°C or less.

Table 3-14. Critical Stability index values for Korea.

INDEX	CRITICAL VALUE
TT	≥ 50
SSI	≤ -1
LI	≤ -1

d. Convective Weather: WSR-88D Guide for Tropical Weather. In Guam, the NWS discovered

for tropical regions, cells should extend at least to the -30°C level, and VIL values should be greater than or equal to 20 kg/m^2 to be considered a thunderstorm. Close to and far away from the radar, echo tops and VIL values always decrease, but reflectivities (dBZ) with thunderstorms tend to hold the strongest values in the middle levels. Values greater than or equal to 40 dBZ above the -10°C height, and composite reflectivity values of 45 dBZ to over 50 dBZ, are other very good indicators.

BIBLIOGRAPHY

- Air Force Global Weather Central, *Air Force Global Weather Central Products*, AFGWCP 105-1, Vol. 3, Offutt AFB, Neb., 1986.
- Air Weather Service, *Conditional Climatology (CC) Tables*, For Your Information # 23, Headquarters Air Weather Service, Scott AFB, Ill., September 1993.
- ., *Forecasting of Aircraft Condensation Trails*, AWS Manual 105-100, Headquarters Air Weather Service, Scott AFB, Ill., 11 March 1960.
- ., *Forecasters' Guide on Aircraft Icing*, AWS Technical Report—80/001, Headquarters Air Weather Service, Scott AFB, Ill., March 1980.
- ., *Isallobaric Wind*, T-TWOS #14, Headquarters Air Weather Service, Scott AFB, Ill., March 1993.
- ., *Meteorological Techniques*, Headquarters Air Weather Service Pamphlet 105-56, Headquarters Air Weather Service, Scott AFB, Ill., 1 August 1979.
- ., *Q-vectors Users Manual*, T-TWOS #1, Headquarters Air Weather Service, Scott AFB, Ill., March 1992.
- ., *Thunderstorm Indices*, Air Weather Service Meteorological Enhancement Team Pamphlet, 1994.
- ., *Use of the Skew T, Log P Diagram in Analysis and Forecasting*, Air Weather Service Technical Report—79/006 Revised, Headquarters Air Weather Service, Scott AFB, Ill., December 1979.
- Ahrens, C. Donald, *Meteorology Today: An Introduction to Weather, Climate, and the Environment*, 5th Edition, West Publishing Company, Minneapolis/St. Paul, Minn., 1994.
- Air Education and Training Command, *Air Education and Training Command Instruction 11-405, Attachment 3*, Randolph AFB, Texas, August 1995.
- Alsruhe, Capt Timothy F., *Forecasting Hints for Japan*, First Weather Wing Forecaster Memo—88/001, Hickam AFB, Hawaii, February 1988.
- Atkins, N. T. and R. M. Wakimoto, “Wet Microburst Activity Over the Southeastern United States: Implication for Forecasting.” *Weather and Forecasting*, Vol 6, 1991.
- American Conference of Governmental Industrial Hygienists, “1995-96 Threshold Limit Values and Biological Exposure Indices,” 1996.
- Bernstein, Ben C., “The Stovepipe Algorithm: Identifying Locations Where Super-Cooled Large Droplets are Likely to Exist.” *Proceedings of the FAA International Conference on Aircraft In-flight Icing, Volume II*, August 1996.
- Best, Donald L., *Maximum and Minimum Temperature Forecasting in Europe*, Second Weather Wing Technical Note—88/002, January 1988.

- Binding, A.A., "Association of Clear Air Turbulence with 300 mb Contour Patterns," *Meteorological Magazine*, 1965, pp. 11 -19.
- Branick, Michael, *A Comprehensive Glossary of Weather Terms for Storm Spotters*, NOAA Technical Memorandum NWS SR-145, September 1996.
- Brooks, H. E., C. A. Doswell III, and J. Cooper, "On the Environments of Tornadic and Nontornadic Mesocyclones." *Weather and Forecasting*, Volume 9, 1994.
- Campbell, TSgt Rodger, "Forecasting Techniques." SC2570 Meteorological Technician, Vol 3 & 4, Extended Course Institute, Maxwell AFB, Ala., 17 February 1994.
- Carle, Ed, *Flash Flood Forecasting Tools*, WRTA 82-26, Salt Lake City, Utah, June 1982.
- Cook, Billie J., "A Snow Index Using 200 mb Warm Air Advection," *National Weather Digest*, Vol 5, May 1980.
- Crisp, MSgt Charlie A., *Training Guide for Severe Weather Forecasters*, Air Force Global Weather Central Technical Note—79/002, Offutt AFB, Neb., November 1979.
- Department of Commerce, *Doppler Radar Meteorological Observations*, Federal Meteorological Handbook, Vol 11D, June 1991.
- Department of the Air Force, *Surface Weather Observations*, AFM 15-111, Headquarters Air Weather Service, Scott AFB, Ill., September 1996.
- , *Weather for Aircrews*, AFM 51-12, Volume 1, Headquarters United States Air Force, 2 April 1990.
- Elliot, George, *Compilation of Weather Forecasting Rules, Techniques, and Procedures*. (McMaster, Greg, Air Force notes-Compilation of Weather Forecasting Rules, Techniques and Procedures-unpublished).
- Ellrod, Gary P., *A Decision Tree Approach to Clear Air Turbulence Analysis Using Satellite and Upper Air Data*, NOAA Technical Memorandum, NESDIS, January 1989.
- ., "The Use of GOES-8 "Multispectral Imagery for the Detection of Aircraft Icing Regions," *NOAA Eighth Conference on Satellite Meteorology and Oceanography*, 28 January-2 February, 1996.
- Evans, Michael S., *A Method for Predicting Severe Weather Thresholds of Vertically Integrated Liquid in West Virginia*, Eastern Region Technical Attachment No. 94-5a, NWSFO, Charleston, West Virginia, May 1994.
- Federal Aviation Administration, *Aeronautical Information Manual, Superintendent of Documents*, GPO, Pittsburgh, Penn., 26 February 1998.
- Finch, Donald L., and Jeffrey P. Walker, *Snowfall at Anchorage Alaska, Associated with Cold Advection* NOAA Technical Memorandum NWS AR-25.
- Frazier, Mark, *The Prediction of Thunderstorm Wind Gusts Based on Vertically Integrated Water Content and Storm Echo Tops*, Eastern Region Technical Attachment No. 94-7b, NWSFO, Pittsburgh, Penn., July 1994.

- Gilligan, George T., ed. *Dhahran, Saudi Arabia Local Forecast Study*, Fifth Weather Wing Forecaster Memo—86/007, Langley AFB, Va., September 1986.
- Godske, C.L., et. al., *Dynamic Meteorology and Weather Forecasting*, American Meteorological Society, 1957.
- Gollehon, Capt George B., *Mediterranean Area Thunderstorm Forecasting*, Second Weather Wing Technical Bulletin, July 1962.
- Haggard, W.G., “CAT Forecasting at the National Meteorological Center of the National Weather Service,” August 1975.
- Haragan, D., et. al., *Elements of Meteorology*, Merrill Publishing Company, Columbus, Ohio, 1983.
- Hart, John A. and Josh Korotky, *The SHARP Workstation Users Manual*, National Weather Service Forecast Office, Charleston, West Virginia.
- Holcomb, Michael C., *Jet Stream Analysis and Turbulence Forecasting*, Air Force Global Weather Central Technical Manual 76-1, Offutt AFB, Neb., 1 March 1976.
- Huschke, R.E., *Glossary of Meteorology*, American Meteorological Society, Boston, Mass., 1959.
- Johnson, G. Alan, and Jeffrey Grascel, *Sea Fog and Stratus: A Major Aviation and Marine Hazard in the Northern Gulf of Mexico*, NWS Forecast Office, New Orleans, La., 1992.
- Johns, R. H., and W. D. Hirt, “Derechos: Widespread Convectively Induced Windstorms,” *Weather and Forecasting*, Vol 2, March 1987.
- Kitchen, SSgt Billy R., and TSgt Duane C. Parker, *Forecasting Techniques for Bradshaw Army Air Field, Hawaii*, First Weather Wing Forecaster Memo—85/001, 31 March 1985.
- Lee, David R., and Roland B. Stull, *Clear Air Turbulence Forecasting Techniques*, Air Force Global Weather Central Technical Note—79/001 (REV), Offutt AFB, Neb., February 1984.
- Lester, Peter F., *Aviation Weather*, Jeppesen Sanderson Training Products, Englewood, Calif., 1995.
- Jimenez, Michael A., *Low-Level Wind Shear: Still Dangerous After All These Years*, 7WW/FM-91/001, May 1991.
- Meteorological Glossary, 6th Edition*, HMSO Publications, London, 1991.
- Miller, Albert, et al, *Elements of Meteorology, Fourth Edition*, Merrill Publishing Company, Columbus, Ohio, 1983.
- Miller, Robert C., *Notes on Analysis and Severe-Storm Forecasting Procedures of the Air Force Global Weather Central*, Air Weather Service Technical Report 200 (Rev), May 1972.
- Morgan, Joseph M., and Michael D. Morgan, *Meteorology, the Atmosphere and the Science of Weather*, MacMillan Publishing Company, New York, 1991.

- Myers, Jane E. and Michael Fitzsimmons, *Case Study Applying the High-Wind Warning Decision Tree*, Eastern Region Technical Attachment No. 89-6, 16 May 1989.
- Nastrom, Gregory D., *Using Hodographs in Thunderstorm Forecasting*, Air Weather Service Forecaster Memo—92/002, Scott AFB, Ill., September 1992
- Naval Education and Training Program Development Center, *Aerographer's Mate 1&C*, NAVEDTRA 10362-B1, GPO, Washington DC, 1985.
- Nestor, LCDR M.J.R., *The Environment of South Korea and Adjacent Sea Areas*, NAVENVPREDRSCHFAC TR 77-03, September 1977.
- Niziol, Thomas A., and Judith M. Levan, "Forecast Procedures for the Mesoscale Lake Induced Snow Events in the Eastern United States." *Symposium on Weather Forecasting*, 1992.
- NOAA Technical Memorandum*, NWS WRTA 92-32, October 1992.
- Opitz, Harold H., "The Challenge of Forecasting Heavy Rain and Flooding throughout the Eastern Region of the National Weather Service. Part II: Forecast Techniques and Applications," *Weather and Forecasting*, Volume 10, Number 1, March 1995.
- Pettett, Capt James, *Climate and Weather Regimes of Korea*, First Weather Wing Forecaster Memo—200/001, December 1980.
- ., *Climate and Weather Regimes of Japan*, 1st Weather Wing Forecaster Memo—200/002, December 1980.
- Pollard, Capt, "An Investigation of Dust Generation in the Southern Great Plains," Thesis, Texas A&M, December 1977.
- Prechtel, Anton S., et. al., *Alaskan Forecasting Techniques*, First Weather Wing Forecaster Memo—90/002, July 1990.
- Quale, Robert, and Fred Doehring, "Heat Stress, A Comparison of Indices," *Weatherwise*, June 1981.
- Rothfus, Lans P., *The Heat Index Equation*, National Weather Service Western Region TA 90-24, July 1990.
- Schmocker, G. K., R. W. Przybilinski, and Y. Lin, "Forecasting the Initial Onset of Damaging Downburst Winds Associated with a Mesoscale Convective System (MCS) Using the Mid-Altitude Radial Convergence (MARC) Signature," *AMS 15th Conference on Weather Analysis and Forecasting*, Norfolk, Va., August 1996.
- Schwerdt, Richard W., *Effect of Wind and Temperature on Humans-Revisited*, National Weather Service Central Region TA 93-04, February 1993.
- Scott, Christopher W., *Variation in the Force of the Wind with Elevation*, National Weather Service Central Region TA 93-12, NWSFO, Cheyenne, Wyoming, 1993.

- Skew-T, Log P Diagram*, National Weather Service Training Center, January 1988.
- Stanton, Thomas E., *Low Level Turbulence Nomogram*, 3rd Weather Wing Technical Note 10, April 1965.
- Stewart, Stacy R., *Wet Microbursts—Penetrative Downdrafts as a Source*, NOAA-NWS, WSR-88D Operational Support Facility, Norman, Okla., September 1995.
- Stone, Robert G., *A Compendium on Cirrus and Cirrus Forecasting*, AWS/TR—105-130, Scott AFB, Ill., March 1957.
- Third Weather Wing, *Summary of Rules for Winter Precipitation Forecasting*, Third Weather Wing Forecaster Memo—80/001, Offutt AFB, Neb., January 1980.
- Synoptic Patterns for Clear Air Turbulence, UAL Meteorology Circular No 56, December 1963.
- Taylor, MSgt Tony D., *Weather Element Forecasting, Flight Hazards, and Limited Data*, SC01W01A Supplemental Forecaster Training, Volume 3, Extended Course Institute, Maxwell AFB, Ala., July 1996.
- Terminal Forecast Reference Notebook*, Wheeler Army Air Field, Hawaii, January 1996.
- Third Weather Wing, *Drizzle*, Third Weather Wing Forecaster Memo—80/002, January 1980, Offutt AFB, Neb., 1980.
- Thunderstorms*, NWS Training Center, Hydrometeorology & Management Division, September 1993.
- Tongue, Jeffrey S., *Single Station Analysis of Surface Observations*, Air Weather Service Forecaster Memo 300/001, Scott AFB, Ill., January 1987.
- United Air Lines, *Mountains and Clear Air Turbulence*, UAL Meteorology Circular No 63, January 1976.
- , *Progress in Forecasting High Level Clear Air Turbulence*, UAL Meteorology Circular No 52, March 1961.
- United States Air Force Environmental Technical Applications Center, *Wet-bulb Globe Temperature, A Global Climatology*, United States Air Force Environmental Technical Applications Center Technical Note—90/005, Scott AFB, Ill., October 1990.
- United States Air Forces Europe, *European Theater Weather Orientation (ETWO)*, USAFE Pamphlet 15-101, 15 November 1995.
- Wagne, James A., *Mean Temperature from 1000 mb to 500 mb as a Predictor of Precipitation Type*, MIT Scientific Report No. 2, May 1957.
- Walters, Kenneth R., and Maj Kathleen M. Traxler, *North Korea: A Climatological Study*, United States Air Force Environmental Technical Applications Center Technical Note—94/003, Scott AFB, Ill., August 1994.
- Wang, Pin-hua, *Sea Fog*, Springer-Verlag, 1985.

Waters, CWO Andrew, *Forecasting Gusty Surface Winds in the Continental United States*, Air Weather Service Technical Report—219, Scott AFB, Ill., January 1970.

———., *Recurring Eastern Asiatic Synoptic Features*, First Weather Wing Technical Study 14, October 1967.

Weather & Korean Climatology, 607th Weather Squadron Pamphlet 15-5, 1 January 1995.

Weber, Eugene M., *Major Snowstorm Development over the Midwest United States*, Third Weather Wing Technical Note 79-2, August 1979.

Wickham, P.G., *The Practice of Weather Forecasting*, Her Majesty's Stationery Office, London, 1983.

World Meteorological Organization, *Techniques for High-Level Analysis and Forecasting of Wind and Temperature Fields*, World Meteorological Organization-106.TP.45.

Yee, *Forecasting Hints for Korea*, First Weather Wing Forecaster Memo—88/003, December 1988.

ABBREVIATIONS AND ACRONYMS

AC	Alto cumulus
ACC	Alto cumulus Castellanus
AFCCC	Air Force Combat Climatology Center
ACSL	Alto cumulus Standing Lenticular
AETC	Air Education Training Command
AFDIS	Air Force Dial-In Subsystems
AFGWC	Air Force Global Weather Center
AFH	Air Force Handbook
AFM	Air Force Manual
AFW	Air Force Weather
AFWA	Air Force Weather Agency
AFWTL	Air Force Weather Technical Library
AIRMET	Airman's Meteorological Information
AGL	Above Ground Level
AS	Altostratus
AWC	National Weather Service Aviation Weather Center
AWDS	Automated Weather Distribution System
BG	Black-Globe Temperature
BQFP	British Quick Fog Point
BKFG	BaroKline Feucht - GMGO (an NWP model)
BRN	Bulk Richardson Number
BWER	Bounded Weak Echo Region
C	Celsius
CAA	Cold Air Advection
CAPE	Convective Available Potential Energy
CAT	Clear Air Turbulence (or Category)
CB	Cumulonimbus
CC	Cirrocumulus or Conditional Climatology
CCL	Convective Condensation Level
CI	Cirrus
CIG	Ceiling
CONTRAIL	Condensation Trail
CONUS	Continental United States
CONV	Convergence
cP	Continental Polar Air mass
CS	Cirrostratus
CT	Cross Totals
CU	Cumulus
DA	Density Altitude
DB	Dry-bulb Temperature
DELTA-T	Temperature Gradient
DPD	Dew Point Depression
DoD	Department of Defense
EHI	Energy/Helicity Index
ESI	European Snow Index
EL	Equilibrium Level
ET	Echo Tops

F	Fahrenheit
FAA	Federal Aviation Administration
FBD	Formatted Binary Data
FE	Field Elevation
FMI	Fawbush-Miller Stability Index
FITS	Fighter Index of Thermal Stress
FL	Flight Level also can be Freezing Level
FSI	Fog Stability Index
GMGO	German Military Geophysical Office
GMS	Geostationary Meteorological Satellite (Far East)
GOES	Geostationary Operational Environmental Satellite (United States)
GSJ	Gollehon Stability Index
Hg	Mercury
HWD	Horizontal Weather Depiction
HP	High Precipitation Supercell
IMC	Instrument Meteorological Conditions
IR	Infrared
ISMCS	International Station Meteorological Climate Summary
ITS	Index of Thermal Stress
K	Cold Air Advection
KI	K-Index
km	Kilometer
KO	KO Index
kt	Knots
L	Light Turbulence
LAFP	Local Analysis and Forecast Program
LAWC	Local Area Work Chart
LC	Low Cloud
LCL	Lifted Condensation Level
LEWP	Line Echo Wave Pattern
LI	Lifted Index
LLJ	Low-level Jet
LLT	Low-level Thickness
LLWS	Low-level Wind Shear
LP	Low Precipitation Supercell
MWA	Military Weather Advisory-Meters
M	Moderate Turbulence
MARWIN	Brand name for rawinsonde equipment.
mb	Millibars
MCC	Mesoscale Convective Complex
MCL	Mixing Condensation Level
MCS	Mesoscale Convective System
METEOSAT	Meteorological Satellite (Europe)
MetTIPs	Meteorological Technical Information Program
METWATCH	Meteorological Watch
MLI	Modified Lifted Index
MODCURVES	Modeled Curves
MODCV	Modeled Ceiling and Visibility
MOGR	Moderate or Greater
MOS	Model Output Statistics
mP	Maritime Polar air mass

M/S	Meters Per Second
mT	Maritime Tropical air mass
MSI	Mean Storm Inflow
MSL	Mean Sea Level
MV	Mountain Wave Turbulence
MVMC	Marginal Visual Meteorological Conditions
MWA	Military Weather Advisory
MX/MN	Maximum/Minimum
N	North, No Tubulence or Current Time
NGM	Nested Grid Model
NM	Nautical Miles
NCAR	National Center for Atmospheric Research
NCEP	National Centers for Environmental Prediction
NE	Northeast
NESDIS	National Environmental Satellite Data and Information Service
NEXRAD	Next Generation Weather Radar
NGM	Nested Grid Model
NOAA	National Oceanic and Atmospheric Administration
NOGAPS	Naval Operational Global Atmospheric Prediction System
NS	Nimbostratus
NVA	Negative Vorticity Advection
NWP	Numerical Weather Prediction
NWS	National Weather Service
OBVIS	Obsrtuction to Vision
OCDS	Operational Climatic Data Summary
OVV	Omega Vertical Velocity
PA	Pressure Altitude
PGF	Pressure Gradient Force
PIREP	Pilot Report
PFJ	Polar Front Jet
PMSV	Pilot-to-Metro Service
POP	Probability of Precipitation
POPT	Probability of Precipitation Type
POR	Period of Record
POSA	Probability of Snow Accumulation
PT	Point
PVA	Positive Vorticity Advection
PWI	Precipitable Water Index
QFE	Station pressure
QNE	Pressure altitude
QNH	Altimeter setting
QPF	Quantitative Precipitation Forecast
R	Base Reflectivity
RAOB	Radiosonde Observation
RAREP	RAdar REPort
RCS	Reflectivity Cross Section
RDA	Radar Data Acquisition
RH	Relative Humidity
RMS	Root Mean Square
RW	Rain Shower
RUSSWO	Revised Uniform Summary of Surface Weather Observations

S	Severe Turbulence
SBLI	Surface-based Lifted Index
SC	Stratocumulus
SCT	Surface Cross Totals
SFC	surface
SHARP	Skew-T/Hodograph Analysis and Research Program
SIGMET	Significant Meteorological Information
SLD	Super-cooled Large Water Droplets
SLP	Sealevel Pressure
SOCS	Surface Observation Climatic Summaries
SRDS	Storm Relative Directional Shear
SRH or s-rH	Storm Relative Helicity
SSI	Showalter Stability Index
ST	Stratus
STJ	Subtropical Jet
SST	Sea Surface Temperature
SWEAT	Severe Weather Threat Index
T	Temperature, Thompson Index
T1	Maximum Land Temperature for Land/Sea Breeze
TAF	Terminal Aerodrome Forecast
TCU	Towering Cumulus
T_d	Dew Point Depression
TFRN	Terminal Forecast Reference Notebook
Theta-E	Equivalent Potential Temperature
THI	Temperature Humidity Index
T_{MAX}	Maximum Temperature
TRW	Thunderstorm/Rain Shower
TT	Total Totals
TTWOS	Technical Transition Manuals
T_v	Virtual Temperature
T_w	Water Temperature
UGDF	Uniform Gridded Data Field
UI	Upper Level Stability Index
UK	United Kingdom
U.S.	United States
USAF	United States Air Force
USN	United States Navy
UTC	Universal Time Coordinate (formerly GMT)
VAD	Velocity Azimuth Display
VCNTY or VC	Vicinity
VIL	Vertically Integrated Liquid
VIS	Visibility, Visible satellite imagery
VMC	Visual Meteorological Conditions
VT	Vertical Totals
VWP	VAD Wind Profile
WAA	Warm Air Advection
WB	Wet-Bulb Temperature
WBG	Wet-Bulb Globe Temperature
WBPT	Wet-Bulb Potential Temperature
WBZ	Wet-Bulb Zero
WMO	World Meteorological Organization

WSR-88D	Weather Surveillance Radar-1988 Doppler
WV	Water Vapor Imagery
X	Extreme
Z	Standard Height (Pressure Altitude)
Za	Actual Height

GLOSSARY

Adiabatic Process. A thermodynamic change of state in a system in which there is no transfer of heat or mass across the boundaries of the system. An example of such a system is the concept of the air parcel. In an adiabatic process, compression always results in warming and expansion in cooling.

Advection. The horizontal transfer of an atmospheric property by the wind.

Ageostrophic Wind. The vector difference between the observed wind and the geostrophic wind.

Air Mass. A large body of air that is largely homogenous both horizontally and vertically in temperature and moisture.

Altimeter Setting. The station pressure reduced to sea level without compensating for temperature. Also, the barometric pressure reading used to adjust a pressure altimeter for variations in existing atmospheric pressure.

Apparent Temperature. What the air temperature “feels like” for various combinations of temperature and relative humidity.

Baroclinic. A state in which a constant-pressure surface intersects a constant density surface. In upper-air products, can be seen where height lines intersect isotherms.

Barotropic. A state in which a constant-pressure surface is coincident with a constant density surface. In upper-air products, can be seen where height lines parallel isotherms.

Bora. Cold, dry, gale-force, gravity-assisted winds that blow down from mountains.

Bounded Weak Echo Region (BWER). (Also known as a “vault.”) A radar signature within a thunderstorm characterized by a local minimum in radar reflectivity at low levels which extends upward into, and is surrounded by, higher reflectivity aloft. This feature is associated with a strong updraft and is almost always found in the inflow region of a thunderstorm. It cannot be seen visually. See WER.

Boundary Layer. Also called Surface Boundary Layer and Friction Layer. The layer of air immediately adjacent to the earth’s surface.

Bow Echo. A radar echo that is linear but bent outward in a bow shape. Damaging straight-line winds often occur near the “crest” or center of a bow echo. Areas of circulation also can develop at either end of a bow echo, which sometimes can lead to tornado formation, especially in the left (usually northern) end, where the circulation exhibits cyclonic rotation.

Convective Available Potential Energy (CAPE). The amount of energy available to create convection; higher values increase the possibility for severe weather.

Centripetal Force. The force that tends to keep an air parcel moving in a curved path, such as isobars.

Chinook. A warm and dry (sometimes very strong) wind that flows down the leeward side of mountains.

Clear Icing. A layer or mass of ice which is relatively transparent because of its homogeneous structure and small number and size of air pockets.

Cloud Streets. Rows of cumulus or cumulus-type clouds aligned parallel to the low-level flow. Cloud streets can sometimes be seen from the ground, but are best seen on satellite imagery.

Coalescence. Usually used to denote the growth of water drops by collision. The term is also used for the growth of an ice particle by collision with water drops.

Cold-Air Advection. The horizontal transport of colder air into a region by wind. See warm-air advection.

Cold-Core Thunderstorms. Thunderstorms formed primarily due to steep lapse rates, especially when very cold air aloft overlies warmer surface air.

Cold Front. The leading edge of an advancing cold air mass that is underrunning and displacing the warmer air in its path. Generally, with the passage of a cold front, temperature and humidity decrease, pressure rises, and the wind shifts (usually from the southwest to the northwest in the Northern Hemisphere). Precipitation is generally at and/or behind the front, and with a fast-moving system, a squall line may develop ahead of the front.

Cold Low. At a given level in the atmosphere, any low that is generally characterized by colder air near its center than around its periphery. A significant case of the cold low is that of a cutoff low, characterized by a completely isolated pool of cold air within its vortex.

Cold Pool. A region of relatively cold air, represented on a weather map analysis as a relative minimum in temperature surrounded by closed isotherms. Cold pools aloft represent regions of relatively low stability, while surface-based cold pools are regions of relatively stable air.

Comma Echo. A thunderstorm radar echo which has a comma-like shape. It often appears during latter stages in the life cycle of a bow echo.

Conditional Instability. Stable unsaturated air that results in instability in the event or on the condition that the air becomes saturated. If the air is saturated, it is considered unstable; if air is unsaturated, it is considered stable.

Condensation. The process in which a vapor is turned into a liquid or solid, such as water vapor into water droplets. Condensation is the opposite of evaporation.

Confluence. A pattern of airflow in which wind direction converges along an axis oriented parallel to the flow. The opposite of diffluence. Confluence can be, but is not necessarily, convergence.

Convection. The mass motion within a fluid, resulting in the transport and mixing of the properties of that fluid. This could be the transport of heat and/or moisture. It is often used to imply only upward vertical motion; in this sense, it is the opposite of subsidence.

Convective Temperature. The temperature the air near the ground must warm to in order for surface-based convection to develop. However, thunderstorms may develop well before or well after the convective temperature is reached (or may not develop at all) due to conditions other than heating. Convective temperature can be a useful parameter for forecasting the onset of convection.

Convergence. A contraction of a vector field; the opposite of divergence. Convergence in a horizontal wind field indicates that more air is entering a given area than is leaving at that level. To compensate for the resulting excess air, vertical motion may result—upward forcing if convergence is at low levels or downward forcing (subsidence) if convergence is at high levels.

Convergent Asymptote. Any horizontal line along which horizontal convergence of the airflow is occurring. See Divergent Asymptote.

Coriolis Force. An apparent force due to the spinning earth that deflects an air parcel to the right of its motion as it moves in the Northern Hemisphere. The force deflects parcels to the left in the Southern Hemisphere.

Density Altitude. Density altitude is the pressure altitude corrected for temperature and humidity.

Derecho. A line of intense, fast-moving thunderstorms that moves across a great distance. They are characterized by damaging straight-line winds over hundreds of miles. Spanish for “straight” or “direct.”

Dew Point. The temperature to which air must be cooled to reach saturation (at constant pressure and water vapor content). Also called dew point temperature.

Diffluence. A pattern of air flow where wind direction spreads apart (or “fans-out”) along an axis oriented parallel to the flow. The opposite of confluence. Diffluence is not the same as divergence. In diffluent flow, winds normally decelerate as they move through the region of diffluence, resulting in speed convergence which offsets the apparent divergence of the diffluent flow.

Divergence. The expansion or spreading out of a vector field resulting in a net outflow of air from a particular region; usually said of horizontal winds. It is the opposite of convergence. Divergence at upper levels of the atmosphere enhances upward motion, and hence the potential for thunderstorm development.

Divergent Asymptote. Any horizontal line along which horizontal divergence of the airflow is occurring.

Downburst. A strong localized downdraft resulting in an outward burst of cool air creating damaging winds at or near the surface. Sometimes the damage resembles tornadic damage. Usually associated with thunderstorms, downbursts can occur with showers too weak to produce thunder. See Microburst.

Downdraft. A sudden descent of a cool or cold column of air towards the ground, usually with precipitation, and associated with a thunderstorm or shower. Contrast with an updraft.

Drainage Wind. A wind directed down the slope of an incline caused by density differences.

Dry Line. The boundary between a dry air mass (e.g., from the desert southwest) and a moist air mass (e.g., from the Gulf of Mexico). The passage of a dry line results in a sharp decrease in humidity, clearing skies, and a wind shift from southeasterly or south to southwesterly or west. It usually lies north-south across the central and southern United States High Plains states during spring and summer, and its presence influences severe weather development in the Great Plains.

Dry Microburst. A microburst with little or no precipitation reaching the ground; most common in semiarid regions. Dry microbursts may develop in an otherwise fair-weather pattern; visible signs may include a cumulus cloud or small cumulonimbus with a high base and high-level virga, or an orphan anvil from a dying rain shower. At the ground, the only visible sign might be a dust plume or a ring of blowing dust beneath a local area of virga. Compare with Wet Microburst.

Dry Slot. An intrusion of dryer air into a region of moist air in the middle levels. Usually seen in the formation of comma clouds.

D-Value. The difference between the true altitude and the standard altitude of a pressure surface.

Empirical. Relying upon or gained from experiment or observation.

Eta Model. NWS forecast model. Eta is not an acronym, but a letter in the Greek alphabet.

Etesian. A prevailing summertime, northerly wind that blows in the eastern Mediterranean.

Evaporation. The process in which a solid or liquid is turned into a gas, such as liquid water turning into water vapor. Evaporation is the opposite of condensation.

Extrapolation. The technique of forecasting the position of a weather feature based solely upon recent past motion of that feature.

Fall Wind. Similar to a drainage wind, but with cold air on a much larger (and stronger) scale.

Fetch. Distance the wind blows over open water.

Flanking Line. A line of cumulus or towering cumulus clouds connected to and extending outward from the most active part of a supercell, normally on the southwest side. The line normally has a stair-step appearance, with the tallest clouds closest to the main storm, and generally coincides with the pseudo-cold front.

Flash Flood. A flood that rises and falls rapidly with little or no advance warning, usually because of intense rainfall over a relatively small area.

Foehn. See Chinook.

Fog. A hydrometeor consisting of visible water droplets suspended in the atmosphere near the earth's surface that restricts visibility below 1000 meters (0.62 miles). Fog can also be considered a cloud on the earth's surface.

Fog Index. An index derived from a formula that uses surface and 850-mb parameters to determine stability. The lower the index, the greater the likelihood of fog. Also called the fog stability index.

Forward-Flank Downdraft. The main region of downdraft in the forward, or leading, part of a supercell, where most of the heavy precipitation is. Compare with Rear-Flank Downdraft.

Gale. A storm with mean wind speeds of 34 knots and gusts of 43 knots.

Geostrophic Wind. A wind that results from the balance of the pressure gradient force and Coriolis Force. It causes winds to blow parallel to isobars.

Gradient Wind. The wind that results from the balance of the sum of the Coriolis Force and the centripetal force and the pressure gradient force.

Gust Front. The leading edge of gusty surface winds from thunderstorm downdrafts; sometimes associated with a shelf cloud or roll cloud. See also Downburst, Outflow Boundary.

Haze. A lithometeor consisting of fine dust, salt, or pollutant particles dispersed through a portion of the atmosphere. The particles are so small they are not felt or individually seen with the naked eye.

Heat Index. An index that combines temperature and relative humidity to determine an apparent temperature. Heat index thresholds are used to indicate the effects of heat and humidity on the human body.

Helicity. A property of a moving fluid which represents the potential for helical flow (flow which follows a corkscrew pattern) to evolve. Helicity is proportional to the strength of the flow, the amount of vertical wind shear, and the amount of turning in the flow (vorticity). Atmospheric helicity is computed from the vertical wind profile in the lower part of the atmosphere (usually from the surface up to 3 km), and is measured relative to storm motion.

High-precipitation Supercell (HP Supercell). A supercell thunderstorm in which heavy precipitation (often including hail) falls on the trailing side of the mesocyclone. Precipitation often totally envelops the region of rotation, making visual identification of any embedded tornadoes difficult and very dangerous. Unlike classic supercells, the region of rotation in many HP storms develops in the front-flank region of the storm. HP supercell storms often produce extreme and prolonged downburst events, serious flash flooding, and very large damaging hail events.

Hodograph. A polar coordinate plot of wind vectors representing the vertical distribution of horizontal winds. Hodograph interpretation can help in forecasting the potential evolution of thunderstorms (squall line vs. supercells, splitting vs. non-splitting storms, tornadic vs. non-tornadic storms, etc.). Also, a method of analyzing a wind sounding. The individual wind vectors at selected levels are plotted head-to-tail on a polar coordinate diagram.

Hook (or Hook Echo). A radar reflectivity pattern characterized by a hook-shaped extension of a thunderstorm echo, usually in the right-rear part of the storm (relative to its direction of motion). A hook often is associated with a mesocyclone, and indicates favorable conditions for tornado development.

Hydrometeors. Any substance produced by the condensation or sublimation of water vapor in the air.

Inflow Notch. A radar signature characterized by an indentation in the reflectivity pattern on the inflow side of the storm. The indentation often is V-shaped, but this term should not be confused with V-notch. Supercell thunderstorms often exhibit inflow notches, usually in the right quadrant of a classic supercell, but sometimes in the eastern part of an HP supercell storm or in the rear part of a storm (rear inflow notch).

Insolation. The intensity at a specified time, or the amount in a specified period, of direct solar radiation incident on a unit of horizontal surface on or above the earth's surface.

Instability. The state of atmospheric equilibrium in which a parcel of air when displaced has a tendency to move further away from its original position (i.e., the tendency to accelerate upward after being lifted). It is a prerequisite condition for spontaneous convection and severe weather to occur. For example, air parcels, when displaced vertically, accelerate upward, often forming cumulus clouds and possibly thunderstorms.

Inversion. A departure from the usual increase or decrease of an atmospheric property with altitude. It usually refers to an increase in temperature with increasing altitude, which is a departure from the usual decrease of temperature with height.

Isallobar. The line of equal change in atmospheric pressure during a certain time period. It marks the change in pressure tendency.

Isallotherm. A line of equal temperature change.

Isobar. A line connecting points of equal pressure.

Isochrone. A line drawn on a map in such a way as to join places at which a phenomenon is observed at the same time, i.e. lines indicating the places at which rain commences at a specified time.

Isodrosotherm. The line connecting points of equal dew point.

Isogon. Line connecting points of equal wind direction.

Isopleth. General term for a line connecting points of equal value of some quantity. Isobars and isotherms are examples of isopleths.

Isotach. A line connecting points of equal wind speed.

Isotherm. A line of equal or constant temperature.

Jet Stream. An area of strong winds concentrated in a relatively narrow band in the upper troposphere of the middle latitudes and subtropical regions of the Northern and Southern Hemispheres. Flowing in a semi-continuous band around the globe from west to east, it is caused by the changes in air temperature where the cold polar air moving towards the equator meets the warmer equatorial air moving poleward. It is marked by a concentration of isotherms and strong vertical shear. Various types include arctic, low level, polar, and subtropical jets.

Kelvin-Helmholtz Instability. Instability arising from a strong vertical shear of wind through a narrow atmospheric layer across which there is a sharp gradient of temperature and density, e.g., at an inversion. A wavelike perturbation may be set up which gains energy at the expense of the large-scale flow.

Land Breeze. A breeze that blows from land to sea at night. Part of the land/sea breeze couplet.

Lapse Rate. The rate of change of temperature with height.

Lithometeor. The general term for dry atmospheric suspensoids, including dust, haze, smoke, and sand.

Line Echo Wave Pattern (LEWP). A bulge in a thunderstorm line producing a wave-shaped “kink” in the line. The potential for strong outflow and damaging straight-line winds increases near the bulge, which often resembles a bow echo. Severe weather potential also is increased with storms near the crest of a LEWP.

Loess. Buff to yellowish brown loamy soil deposited by wind.

Low-level Jet. Strong winds that are concentrated in relatively narrow bands in the lower part of the atmosphere. It is often amplified at night. The southerly wind over the United States plains states during spring and summer is a notable example. See Jet Stream.

Low-precipitation Supercell (LP Supercell). A supercell thunderstorm characterized by a relative lack of visible precipitation. Visually similar to a classic supercell, except without the heavy precipitation core. LP supercell storms often exhibit a striking visual appearance; the main tower often is bell-shaped, with a corkscrew appearance suggesting rotation. They are capable of producing tornadoes and very large hail. Radar identification often is difficult relative to other types of supercells, so visual reports are very important. LP supercell storms usually occur on or near the dry line, and thus are sometimes referred to as dry line storms.

Macroscale. The meteorological scale for obtaining weather information covering an area ranging from the size of a continent to the entire globe. Systems have a horizontal size greater than 1500 NM and duration from several days to over a week, e.g., long waves and semipermanent pressure systems.

Maritime Air Mass. An air mass influenced by the sea. It is a secondary characteristic of an air mass classification, signified by the small “m” before the primary characteristic, which is based on source region. For example, mP is an air mass that is maritime polar in nature. Also known as a marine air mass.

Mesoscale. Systems vary in size horizontally from 1 to 500 NM and duration from tens of minutes to several hours. This includes mesoscale convective complexes, mesoscale convective storms, and squall lines. Smaller phenomena are classified as microscale, while larger are classified as synoptic-scale.

Mesocyclone. A storm-scale region of rotation, typically 2 to 6 miles in diameter and often found in the right rear flank of a supercell (or often on the eastern, or front, flank of an HP supercell). The region of a mesocyclone is a known area for tornadogenesis. Mesocyclone used as a radar term is defined as a rotation signature appearing on Doppler radar that meets specific criteria for magnitude, vertical depth, and duration.

Mesoscale Convective Complex (MCC). A large round or oval shaped mesoscale convective system (MCS), approximately 100,000 km², lasting at least 6 hours. Generally forming during the afternoon and evening during which the threat of severe weather is the greatest. It normally reaches its peak intensity at night when heavy rainfall and flooding become the primary threat. However, severe weather may occur at any time.

Mesoscale Convective System (MCS). A large organized convective weather system comprised of a number of individual thunderstorms. It normally persists for several hours and may be rounded or linear in shape. This term is often used to describe a cluster of thunderstorms that does not meet the criteria of a mesoscale convective complex (MCC).

Metamorphism. A pronounced change in internal structure due to pressure, heat, and water that results in a more compact and more highly crystalline condition, e.g., snow pack changing to ice.

Microburst. A severe localized wind blasting down from a thunderstorm. It covers an area less than 2.5 miles (4 km) in diameter and is of short duration, usually less than 5 minutes. See downburst.

Microscale. Systems have a horizontal size less than 1 NM and duration from a few seconds to a few minutes. These comprise the smallest weather systems.

Middle Latitudes. The latitude belt roughly between 35° and 65° North and South. Also referred to as the temperate region.

Mie Scattering. Scattering of energy in a forward direction from particles in the air.

Mixed Icing. A combination of clear and rime icing.

Mountain Breeze. A breeze that descends a mountain slope during the night. It is stronger than a drainage wind and caused by surface cooling of an incline.

Mountain Waves. Waves formed on the leeside (lee waves) of a mountain barrier, characterized by strong turbulence.

Nephanalysis. The analysis of a synoptic product in terms of the types and amount of clouds and/or precipitation.

Notorious Wind Boxes. Ten areas of strong wind-gust patterns in the United States.

Orographic. Related to, or caused by, physical geography such as mountains or sloping terrain.

Outflow Boundary. A storm-scale or mesoscale boundary separating thunderstorm-cooled air (outflow) from the surrounding air; similar in effect to a cold front, with passage marked by a wind shift and usually a drop in temperature. Outflow boundaries may persist for 24 hours or more after the thunderstorms that generated them dissipate, and may travel hundreds of miles from their area of origin. New thunderstorms often develop along outflow boundaries, especially near the point of intersection with another boundary (cold front, dry line, another outflow boundary, etc.).

Overrunning. Refers to an air mass moving over a denser surface air mass, such as warm air moving over a cold air mass in a warm front. This occurs when a relatively warm air mass is forced above a cooler air mass of greater density that is at the surface. Weather generally associated with this event includes cloudiness, cool temperatures, and steady rain.

Persistence. The tendency for a phenomenon to occur in the future, given it occurred in the immediately preceding time period. For example, if it rained the last two hours, it rains during the next hour.

Pressure Altitude. The altitude in the standard atmosphere for a given station pressure.

Pressure Gradient Force (PGF). The primary force responsible for winds. It arises from spatial atmospheric pressure differences and acts in the direction from high to low pressure.

Pseudo-cold Front. A boundary between a supercell's inflow region and the rear-flank downdraft. It extends outward from the mesocyclone center, usually toward the south or southwest (but occasionally bows outward to the east or southeast in the case of an occluded mesocyclone), and is characterized by advancing of the downdraft air toward the inflow region. It is a particular form of gust front.

Pulse Storm. A thunderstorm within which a brief period (pulse) of strong updraft occurs, during and immediately after which the storm produces a short episode of severe weather. These storms generally are not tornado producers, but often produce large hail and/or damaging winds.

Q-Vector. A measure of atmospheric motion that combines temperature advection and divergence due to changes in vorticity advection with height.

Rain-free Base. A dark, horizontal cloud base with no visible precipitation beneath it. It typically marks the location of the thunderstorm updraft. Tornadoes may develop from wall clouds attached to the rain-free base, or from the rain-free base itself—especially when the rain-free base is on the south or southwest side of the main precipitation area.

Rear Flank Downdraft. Regions of dry air subsiding on the backside of, and wrapping around, a mesocyclone. It often is visible as a clear slot wrapping around the wall cloud. Scattered large precipitation particles (rain and hail) at the interface between the clear slot and wall cloud may show up on radar as a hook or pendant; thus the presence of a hook or pendant may indicate the presence of an RFD.

Relative Humidity. An indicator of moisture in the air, expressed as a percentage. It is the ratio of the mixing ratio to the saturation-mixing ratio of the air.

Rime Icing. Deposit of white, rough ice crystals which form when supercooled water droplets of fog come into contact with a solid object (aircraft) at a temperature below 0°C.

Santa Ana Wind. A hot, dry, Chinook-like wind that is channeled in the pass and river valley of Santa Ana, California.

Sea Breeze. A breeze that blows from sea to land during the day.

Shamal. The northwest wind in the lower valley of the Tigris and Euphrates and the Persian Gulf. Although the wind rarely exceeds 30 knots, it is very hot, dry, and dusty.

Shear. The change in wind speed (speed shear) and/or direction (directional shear) over a short distance. It can occur vertically, such as a change with height (vertical wind shear), or horizontally. The term also is used in Doppler radar to describe changes in radial velocity over short horizontal distances.

Sirocco. Also spelled scirocco. A warm south or southeast wind that blows from the Sahara desert across North Africa and the southern Mediterranean Sea.

Squall. A sudden onset of strong winds with speeds increasing to at least 16 knots and sustained at 22 or more knots for at least one minute. The intensity and duration is longer than that of a gust.

Squall Line. A narrow band or line of active thunderstorms that is not associated with a cold front. It may form from an outflow boundary or the leading edge of a mesohigh.

Stable/Stability. Occurs when a rising air parcel becomes denser than the surrounding air. It then returns to its original position. When the density of the air parcel remains the same as the surrounding air after being lifted, it is also considered stable, since it does not have the tendency to rise or sink further. Contrast with unstable air and instability.

Standard Atmosphere. The internationally agreed upon vertical distribution of temperature, pressure, and density taken as representative of the atmosphere.

Storm Scale. Refers to weather systems with sizes on the order of individual thunderstorms. See Synoptic Scale, Mesoscale.

Straight-line Winds. Generally, any wind that is not associated with rotation, used mainly to differentiate from tornadic winds.

Streamline. Arbitrarily spaced lines whose tangent at any point in the flow is parallel to the horizontal velocity vector at a particular level at a particular instant in time.

Subsidence. A sinking or downward motion of air, often seen in anticyclones. It is most prevalent when there is colder, denser air aloft. It is often used to imply the opposite of atmospheric convection.

Supercell. A severe thunderstorm characterized by a rotating, long-lived, intense updraft. Although not very common, they produce a relatively large amount of severe weather, in particular, extremely large hail, damaging straight-line winds, and practically all violent tornadoes.

Suspensoid. A system composed of one substance dispersed throughout another substance. E.g., dust dispersed through the atmosphere.

Synoptic Scale (or Large Scale). Size scale referring generally to weather systems with horizontal dimensions of several hundred miles or more. Most high and low pressure areas seen on weather maps are synoptic-scale systems. Systems vary in size horizontally from 500 NM to 1,000 NM and duration from tens of hours to several days, e.g., migratory cyclones and frontal systems.

Tail Cloud. A horizontal, tail-shaped cloud (not a funnel cloud) at low levels extending from the precipitation cascade region of a supercell toward the wall cloud (usually observed extending from the wall cloud toward the north or northeast). The base of the tail cloud is about the same as that of the wall cloud. Cloud motion in the tail cloud is away from the precipitation and toward the wall cloud, with rapid upward motion often observed near the junction of the tail and wall clouds.

Thermal Ribbon. A band of closely spaced isotherms.

Trajectory. The path in the atmosphere tracing the points successively occupied by an air parcel in motion.

Triggering Mechanism. An event or causative factor that acts to set in motion extreme thermodynamic reaction in the troposphere.

Tropopause. The upper boundary of the troposphere, between the troposphere and the stratosphere, usually characterized by an abrupt change in lapse rate from positive (decreasing temperature with height) to neutral or negative (temperature constant or increasing with height).

Unstable/Instability. Occurs when a rising air parcel becomes less dense than the surrounding air. Since its temperature does not cool as rapidly as the surrounding environment, it continues to rise on its own.

Updraft. A small-scale current of rising air. If the air is sufficiently moist, then the moisture condenses to become a cumulus cloud or an individual tower of a towering cumulus or cumulonimbus.

Valley Breeze. A wind that ascends a mountain slope during the day.

Virtual Temperature. In a given air mass, the temperature of dry air having the same density and pressure as the given air mass. This temperature is always greater than the actual temperature.

Visibility. The greatest distance in a given direction at which it is just possible to see and identify with the unaided eye: in the daytime, a prominent dark object against the sky at the horizon; at night, a preferably unfocused, moderately intense light source.

V-notch. A radar reflectivity signature seen as a V-shaped notch in the downwind part of a thunderstorm echo. The V-notch often is seen on supercells, and is thought to be a sign of diverging flow around the main storm updraft (and hence a very strong updraft). This term should not be confused with inflow notch or with enhanced V, although the latter is believed to form by a similar process.

Vorticity. A measure of the local rotation in a fluid flow. It usually refers to the vertical component of rotation (rotation about a vertical axis) and is used most often in reference to synoptic scale or mesoscale weather systems. By convention, positive values indicate cyclonic rotation.

Wall Cloud. A localized, persistent, often abrupt lowering from a rain-free base. Wall clouds can range from a fraction of a mile up to nearly 5 miles in diameter, and normally are found on the south or southwest (inflow) side of the thunderstorm. When seen from within several miles, many wall clouds exhibit rapid upward motion and cyclonic rotation. However, not all wall clouds rotate. Rotating wall clouds usually

develop before strong or violent tornadoes, by anywhere from a few minutes up to nearly an hour. Wall clouds should be monitored visually for signs of persistent, sustained rotation, and/or rapid vertical motion.

Warm-air Advection. The horizontal transport of warmer air into a region by wind.

Warm Cloud Top Rain. Rain that falls from clouds whose tops do not reach the freezing level. The coalescence process initiates such rain.

Weak Echo Region (WER). Radar term for a region of relatively weak reflectivity at low levels on the inflow side of a thunderstorm echo, topped by stronger reflectivity in the form of an echo overhang directly above it. The WER is a sign of a strong updraft on the inflow side of a storm, within which precipitation is held aloft. When the area of low reflectivity extends upward into, and is surrounded by, the higher reflectivity aloft, it becomes a bounded WER (BWER).

Wet Microburst. A microburst accompanied by heavy precipitation at the surface. A rain foot may be a visible sign of a wet microburst. See Dry Microburst.

Whiteout. An atmospheric optical phenomenon of the polar regions in which the observer appears to be engulfed in a uniformly white glow. Shadows, horizon, or clouds are not discernible; sense of depth and orientation is lost; only very dark, nearby objects can be seen.

Yellow Wind. Dust in the Far East lifted and advected from the Gobi Desert by strong winds.

Zagros Mountains. Mountains in western and southern Iran bordering on Turkey, Iraq, and the Persian Gulf. The highest peaks are over 14,000 feet (4267 meters).

SUBJECT INDEX

References are to page numbers. Definitions of technical terms are found in the glossary, which is not indexed here.

A

Aircraft icing

- icing formation processes and classification 2-48
 - classification 2-49
 - icing intensities 2-50
 - light 2-50
 - moderate 2-50
 - severe 2-50
 - trace 2-50
 - icing types 2-49
 - clear icing 2-49
 - frost icing 2-49
 - mixed icing 2-49
 - rime icing 2-49
 - processes 2-48
 - conduction and evaporation 2-49
 - sublimation 2-49
 - supercooled water droplets 2-48
 - meteorological considerations 2-50
 - cloud type 2-50
 - stratiform 2-50
 - cirriform clouds 2-51
 - cumuliform 2-50
 - frontal systems 2-51
 - above the frontal surface aloft 2-51
 - below the upper frontal surface aloft 2-51
 - frontal icing characteristics 2-52
 - cold fronts 2-52
 - stationary and occluded fronts 2-52
 - warm fronts 2-52
 - other icing conditions 2-52
 - induction icing 2-52
 - air intake ducts 2-53
 - carburetor icing 2-53
 - terrain 2-52
 - methods and rules of thumb for the “negative 8 times d” 2-58
 - 8d method; procedures 2-58
 - 8d method; rules of thumb 2-59
 - products and procedures 2-54
 - centralized products 2-54
 - afwa high-level and low-level hazard charts 2-54
 - airmets and sigmets 2-54
 - military weather advisories (mwa) 2-54

- surface products 2-57
- upper-air reports, data, and products 2-54
 - other composites 2-55
 - horizontal weather depiction (hwd) 2-55
- icing from freezing precipitation 2-55
- pireps and aireps 2-54
- upper-air composites on awds 2-54
 - moisture 2-55
 - thermal advection patterns 2-55
 - vorticity 2-54
 - wind speed (jet stream) 2-54
- upper-air data 2-54
- vertical cross section 2-55
 - relative humidity (RH) 2-55
 - temperature and dew-point depression–icing occurrence 2-55
 - temperatures– icing types 2-55
- standard system applications 2-57
 - radar 2-57
 - bright band identification 2-57
 - cold air advection (caa) 2-57
 - freezing level 2-57
 - moisture 2-58
 - satellite imagery 2-58
 - goes-8 and goes-9 imagery 2-58
 - channel 1 (visible) 2-58
 - channel 2 (near infrared) 2-58
 - channel 4 (infrared or ir) 2-58
 - channel comparisons 2-58
 - gms and meteosat 2-58
- variables for determining icing accumulation 2-50
 - aircraft size and shape 2-50
 - airspeed 2-50
 - droplet size 2-50

C

Classic synoptic convective weather patterns

- cold core 3-10
 - initial outbreak area 3-10
 - pattern characteristics 3-10
 - timing 3-11
 - triggering mechanisms 3-11
- dryline pattern 3-6
 - initial outbreak area 3-6
 - pattern characteristics 3-6
 - severe weather area 3-6
 - timing 3-7

- triggering mechanisms 3-7
- frontal pattern 3-7
 - initial outbreak area 3-8
 - pattern characteristics 3-8
 - secondary outbreak area 3-8
 - timing 3-8
 - triggering mechanisms 3-8
- overrunning pattern 3-8
 - initial outbreak area 3-9
 - pattern characteristics 3-9
 - timing 3-10
 - triggering mechanisms 3-10
- squall line 3-11
 - initial outbreak areas 3-12
 - pattern characteristics 3-11
 - secondary outbreak areas 3-12
 - timing 3-12
 - triggering mechanisms 3-12

Clouds

- cloud forecasting techniques 2-6
 - determining cloud heights 2-6
 - base of convective clouds using dew point depressions 2-7
 - relative humidity and vertical velocity 2-8
 - using skew-t, log p diagram 2-6
 - parcel method 2-7
 - moist layer method 2-7
 - cloud amounts 2-9
 - forecasting clouds in relation to 700 mb features 2-9
 - using dew-point depressions 2-9
 - forecasting cirrus clouds 2-10
 - advective cirrus 2-10
 - convective cirrus 2-12
 - tropopause method of forecasting cirrus 2-12
 - formation, advection, and dissipation of low stratus 2-9
 - dissipation of stratus using mixing ratio and temperature 2-10
 - empirical rules 2-9
 - wind speed 2-9
 - precipitation induced clouds 2-12
 - rain 2-12
 - snow 2-12
 - rules of thumb 2-13
- cloud types/states of the sky 2-1
 - high clouds 2-2
 - cirrocumulus (cc) 2-2
 - cirrostratus (cs) 2-2
 - cirrus (ci) 2-2
 - low clouds 2-1
 - cumulonimbus (cb) 2-1
 - cumulus (cu) 2-1

- stratocumulus (sc) 2-1
- stratus (st) 2-1
- middle clouds 2-1
 - altocumulus (ac) 2-2
 - altostratus (as) 2-1
 - nimbostratus (ns) 2-2
- cloud types with a mature wave cyclone 2-2
- general forecasting tools 2-3
 - climatology 2-3
 - conditional climatology 2-3
 - category-based cc 2-3
 - time-based cc 2-3
 - international station meteorological climate summaries 2-3
 - modeled ceiling/visibility (MODCV) 2-3
 - modeled curves (MODCURVES) 2-4
 - station climatic summaries 2-3
 - surface observation climatic summaries (SOCS) 2-4
 - extrapolation 2-5
- model and centralized guidance 2-4
 - afwa trajectory forecast bulletins 2-4
 - model output statistics (mos) 2-4
 - r1, r2, and r3 values 2-4
- weather radar 2-5
 - echo tops (ET) 2-6
 - reflectivity (R) 2-6
 - reflectivity cross section (RCS) 2-6
 - vertical azimuth display (VAD) wind profile (VWP) 2-6
- regional guidance 2-13
 - conus regional guidance 2-14
 - conus main moisture stratus tracks 2-17
 - type 1 2-17
 - type 2 2-18
 - type 3 2-18
 - LLJ or near LLJ present 2-16
 - stratus in the midwest and the low-level jet (LLJ) 2-14
 - European regional guidance 2-13
 - European grid forecasts for clouds 2-13

Convective weather tools

- general rules of thumb 3-28
 - severe thunderstorms 3-28
 - onset of typical thunderstorms 3-28
- identifying severe weather features 3-17
 - boundaries and boundary interaction features 3-22
 - mwa products 3-23
 - radar - WSR-88d 3-23
 - satellite 3-22
 - streamline analysis/sea breeze onset 3-23
 - bow echo features 3-21
 - tornado features 3-17

- non-super-cell tornadoes 3-21
 - supercell tornadoes 3-21
 - wet microburst features 3-21
- regional rules of thumb 3-28
 - Alaska 3-28
 - Europe and eastern Mediterranean 3-29
 - Korea 3-29
 - severe thunderstorms
 - central Europe 3-30
 - north and central Europe 3-30
- synoptic evaluation for potential severe weather 3-17
- stability indices 3-12
 - Bulk Richardson number (BRN) 3-12
 - convective available potential energy 3-12
 - cross totals (CT) 3-13
 - dynamic index 3-13
 - energy/helicity index (EHI) 3-13
 - Fawbush-Miller stability index (FMI) 3-13
 - GSI index 3-13, 3-29
 - k index (KI) 3-13
 - ko index (KO) 3-13
 - lifted index (LI) 3-14
 - mean storm inflow (MSI) 3-14
 - modified lifted index (MLI) 3-14
 - modified stability indices 3-29
 - s index (S) 3-14, 3-30
 - showalter stability index (SSI) 3-14, 3-29
 - storm relative directional shear (SRDS) 3-14
 - storm-relative helicity (S-RH) 3-14
 - surface cross totals (SCT) 3-14
 - thompson index (TI) 3-14
 - total totals (TT) 3-14, 3-29
 - vertical totals (VT) 3-14
 - wet-bulb zero height (WBZ) 3-15
 - wet-bulb potential temperature at 850-mb 3-30
- techniques 3-23
 - forecasting convective wind gusts 3-23
 - t1 gust computation 3-23
 - t1 method 1 3-24
 - t1 method 2 3-24
 - t2 gust computation 3-24
 - high-based thunderstorm method 3-25
 - derecho checklist 3-26
 - snyder method 3-26
- forecasting hail and hail size 3-26
 - forecasting hail (using skew-t) 3-26
 - forecasting hail size (using skew-t) 3-26

forecasting hail size using vil density 3-28
severe thunderstorm checklist 3-23

D

Dry obstructions

dry haze 1-3
duststorm generation 1-3

H

Hydrometeors

precipitation 1-1
suspended (liquid or solid) water particles 1-1
 advection fog 1-2
 frontal fog 1-2
 ice fog 1-2
 radiation fog 1-2
 upslope fog 1-2
whiteout conditions 1-1, 1-2

I

Lithometeors

dry haze 1-1
 dust 1-1
 sand 1-1
smoke 1-1

M

Miscellaneous weather elements

climb winds 2-60
 skew-t, log p diagram 2-61
 time cross section—time log-p winds 2-61
 upper-air products 2-60
 upper-air soundings 2-61
 vertical azimuth display (vad) wind profile (vwp) 2-61
contrails 2-62
contrail types 2-62
 aerodynamically induced 2-62
 engine exhaust induced 2-62
 forecasting probability of contrail formation 2-62

- instability induced 2-62
- d-values 2-64
 - skew-t 2-64
 - upper-air data 2-64
 - upper-air products 2-64
- flight level winds 2-60
 - constant pressure products 2-60
- temperature 2-61
- thunderstorms 2-61

P

Precipitation

- determining precipitation type 1-27
- thickness 1-27
 - analyzing/extrapolating patterns 1-27
 - CONUS 1-29
 - Korea and Japan 1-29
 - UK and northwestern Europe 1-30
- nomograms 1-30
- temperature 1-30
 - air temperature 1-31
 - height of the wet-bulb freezing level (UK and northwestern Europe) 1-32
 - wet-bulb temperature 1-31
- models (NGM & Eta) 1-32
- freezing precipitation indicators 1-32
 - European snow index (esi) 1-32
 - height of freezing level 1-33
 - multiple freezing levels 1-33
 - single freezing level 1-33
- snow vs freezing drizzle 1-34
- forecasting rainfall amounts 1-34
 - heavy rainfall 1-37
 - excessive rainfall checklist for the east central 1-37
 - radar signatures associated with flash floods 1-37
 - satellite signatures 1-37
- quantitative method 1-34
 - 850-mb trough is east of 100°w longitude 1-36
 - 850-mb trough is west of 100°w longitude 1-34
- general guidance 1-23
- cloud-top temperatures 1-23
- dew-point depression 1-23
- extrapolation 1-23
- associating precipitation with fronts 1-23
 - cold fronts 1-23
 - forecasting procedures for post-frontal precipitation 1-24
 - synoptic pattern 1-23
 - warm front—overrunning 1-25

- drizzle formation 1-26
- model guidance 1-22
- obstruction to vision (obvis) 1-22
- visibility (vis) 1- 22
- snowfall 1-38
 - Alaska 1-48
 - cold advection snow (southern Alaska) 1-48
 - determining snowfall accumulation 1-48
 - snow associated with the arctic front in Alaska 1-49
 - central Japan 1-44
 - estimating rates/accumulation 1-38
 - snow index using 200-mb warm advection 1-38
 - using precipitable water index (pwi, ppw on awds skew-t) 1-39
 - using weather and visibility 1-38
 - forecasting snow showers 1-39
 - heavy snow 1-41
 - favorable synoptic patterns 1-42
 - jet stream snow bursts 1-43
 - locating areas of maximum 12-hour snowfall 1-41
 - non-convective snowfall 1-41
 - satellite techniques 1- 42
 - shear zone heavy snow events 1-42
 - shear zone interpretation technique 1-42
 - Korea 1-44
 - forecast aids for instability snow showers at 1-44
 - lake effect snow at Kunsan AB, Korea 1-44
 - lake effect snow 1-40
 - Midwestern United Sates 1-46
 - heavy snow track pattern 1 1-47
 - heavy snow track pattern 2 1-47
 - heavy snow track pattern 3 1-48
 - northeastern U.S. 1-45
 - UK and Germany 1-44
 - western U.S. 1-48

Pressure

- general guidance 1-93
 - diurnal considerations 1-94
 - air mass effects 1-94
- standard atmosphere 1-94
- pressure-related parameters 1-94
 - computing SLP 1-94
 - altimeter setting 1-95
- pressure conversion products 1-96
 - QNH 1-95
 - d-value 1-98
 - computed 1-98
 - graphical 1-98
 - density altitude (DA) 1-97
 - computed 1-97
 - graphical 1-97

- pressure altitude (pa) 1-96
- sea-level pressure 1-96
- modeled output 1-95

S

Surface winds

- atmospheric forces 1-51
 - centrifugal and centripetal forces 1-51
 - coriolis force 1-51
 - frictional force 1-51
 - pressure gradient force 1-51
- Balkans and eastern Europe 1-79
- Europe 1-76
 - Alpine region 1-78
 - Central Plains 1-78
 - North Atlantic 1-77
 - northern Europe 1-78
- flow around pressure systems 1-51
- forecasting gusty surface winds in the united states 1-66
 - high wind warning decision flowcharts 1-66
 - notorious wind boxes 1-66
 - Appalachian mountain 1-73
 - Central Plains 1-72
 - Dusty 1-71
 - Frisco 1-70
 - Great Lakes 1-72
 - Livingston 1-71
 - Los Angeles 1-70
 - Northern Plains 1-71
 - Pacific Northwest 1-66
 - Utah 1-70
- general tools for forecasting surface winds 1-52
 - climatology 1-52
 - international station meteorological climate summary 1-52
 - station climatic summaries 1-52
 - surface observation climatic summaries (SOCS) 1-52
 - diurnal temperature data 1-56
- elevation effects 1-60
- geostrophic winds 1-52
- gradient winds 1-53
- isallobaric winds 1-54
- local wind effects 1-60
 - drainage wind 1-60
 - fall wind 1-60
 - foehn (chinook) wind 1-61
 - land and sea breezes 1-61
 - mountain breeze 1-60
 - valley breeze 1-61
- numerical output products 1-57
 - conus 1-57

- European theater 1-57
- Pacific theater 1-57
- satellite-derived winds 1-58
 - satellite imagery 1-58
 - bow waves, plume clouds, karman vortices 1-59
 - closed-cell stratocumulus 1-58
 - cumulus lines or streets 1-59
 - ice packs on large lakes and seas 1-59
 - lakes in summer 1-59
 - lakes in winter 1-59
 - leeside clearing 1-59
 - open-cell cumulus 1-58
 - smoke/ash/dust 1-59
 - stratocumulus lines 1-58
 - strongest wind regions in extratropical cyclones 1-59
- topography 1-52
- trends 1-52
- uniform gridded data fields (UGDFS) 1-58
- wind profiles 1-57
 - Guam 1-75
 - Hawaii 1-75
 - Japan 1-73
 - central 1-74
 - northern 1-73
 - southern 1-74
 - Korea 1-73
 - Mediterranean and North Africa 1-79
 - bora 1-81
 - etesian winds 1-79
 - mistral 1-83
 - sirocco 1-80
 - Okinawa and the Ryukyu Islands 1-75
- specialized airfield operations topics 1-62
 - low-level wind shear 1-65
 - cold frontal boundary 1-65
 - land and sea breezes 1-65
 - low-level inversions 1-65
 - low-level jet 1-65
 - mountain-wave conditions 1-65
 - thunderstorm gust front 1-65
 - warm frontal boundary 1-65
 - runway crosswinds 1-62
- wind types 1-51
 - actual wind 1-51
 - geostrophic wind 1-51
 - gradient wind 1-51

T

Temperatures

- forecasting max temperatures 1-87
 - using the skew-t, log p diagram 1-87
 - broken to overcast sky conditions 1-87
 - clear to scattered sky conditions 1-87
 - when a low-level inversion is present 1-88
 - when a warm front approaches 1-87
 - within an air mass 1- 86
- general temperature forecasting tools 1-84
 - additional rules of thumb 1-88
 - forecasting with limited data 1-88
 - high winds and cooling 1-89
 - humidity and cooling 1-89
 - afwa trajectory forecast bulletins 1-86
 - climatology 1-84
 - conditional climatology (CC) tables 1-84
 - international station meteorological climate summaries 1-84
 - modeled curves (modcurves) 1-84
 - station climatic summaries 1-84
 - surface observation climatic summaries (SOCS) 1-84
 - extrapolation 1-86
 - model output statistics 1-85
 - hourly temperatures (temp) 1-85
 - limitations of the ngm mos 1-85
 - maximum/minimum temperatures (mx/mn) 1-85
 - modifying ngm mos temperature forecasts 1-85
 - persistence 1-86
 - temperature forecasting checklist 1-86
- minimum temperature forecasts 1-88
 - after cold frontal passage 1-88
 - craddock's minimum temperature formula 1-88
 - using dew point 1-88
 - using the skew-t, log p diagram 1-88
- temperature indices 1-89
 - fighter index of thermal stress (FITS) 1-91
 - heat index 1-90
 - index of thermal stress 1-93
 - caution zone 1-93
 - danger zone 1-93
 - index of thermal stress (ITS) 1-93
 - temperature-humidity index (THI) 1-89
 - wet-bulb globe temperature (WBGT) heat stress index 1-90
 - computing the WBGT index 1-90
 - effects of WBGT 1-91
 - wind chill 1-93

Thunderstorms

- thunderstorm types 3-1
 - derechos 3-4
 - dry, wet, and hybrid microbursts 3-3
 - multicellular 3-1
 - associated severe weather 3-2
 - multicellular storm indicators 3-2
 - single cell 3-1
 - associated severe weather 3-1
 - single cell storm indicators 3-1
 - supercell 3-2
 - classic supercells 3-2
 - high precipitation (HP) supercells 3-3
 - low precipitation (LP) supercells 3-3

V

Visibility

- forecasting aids/techniques 1-17
 - forecasting visibility using climatology 1-8
 - climatic briefs 1-21
 - international station meteorological climate summary 1-22
 - modeled ceiling and visibility (MODCV) 1-20
 - modeled diurnal curves (MODCURVES) 1-21
 - operational climatic data summary (OCDS) 1-21
 - regional climatological studies 1-22
 - station climatic summaries 1-21
 - surface observation climatic summaries (SOCS) 1-21
 - theater climatic files 1-22
 - fog 1-6
 - determining fog height 1-18
 - dissipating radiation fog 1-19
 - dissipation 1-6
 - fog point 1-18
 - fog stability index 1-19
 - fog threat 1-19
 - formation 1-6
 - general forecasting guidance 1-7
 - graphical method for forecasting fog 1-18
 - skew-T technique 1-20
 - specific forecast guidance 1-7
 - radiation fog 1-8
 - advection fog 1-7
 - frontal fog 1-9
 - model output statistics (MOS) guidance 1-22
 - using streamlines to forecast visibility 1-17
 - rules of thumb 1-3

- dry obstructions to visibility 1-4
 - central Japan 1-4
 - Far East (Yellow Wind) 1-4
 - Mediterranean 1-5
 - Okinawa 1-4
 - Saudi Peninsula 1-5
 - southern Japan 1-4
- moist obstructions to visibility 1-5
 - Alaska 1-14
 - central Japan 1-13
 - Europe 1-9
 - Korea 1-13
 - Mediterranean 1-11
 - winter fog in the northern Mediterranean 1-12
 - northern Gulf of Mexico 1-14
 - cold advection fog 1-17
 - frontal fog 1-17
 - radiation fog 1-17
 - warm advection fog 1-15
 - northern Japan 1-12
 - Okinawa 1-13
 - southern Japan 1-13
 - United Kingdom 1-11