

KI-NA-24328-EN-C

The ocean presently takes up one-fourth of the carbon dioxide emitted to the atmosphere by human activities, thereby increasing ocean acidity. While our understanding of the possible consequences of ocean acidification is still rudimentary, both the scientific community and the society at large are increasingly concerned about the potential risks associated with ocean acidification for marine organisms and ecosystems. The number of scientists involved in ocean acidification research grew rapidly over the past few years and will continue to rise with the launch of new coordinated national programmes. Students, young researchers, and established scientists inexperienced with the intricacies of the seawater carbonate chemistry and perturbation experiments will enter the field and will benefit from guidelines and standards for ocean acidification research. The European Project on Ocean Acidification (EPOCA) and the Intergovernmental Oceanographic Commission (IOC) initiated the process that led, after an open community review, to the production of this guide.

Guide to best practices for ocean acidification research and data reporting EUR 24328 EN



EUROPEAN  
COMMISSION

European  
Research Area

# Guide to best practices for ocean acidification research and data reporting

EUR 24328 EN

GENERAL INFORMATION



Publications Office



## Interested in European research?

**Research\*eu** is our monthly magazine keeping you in touch with main developments (results, programmes, events, etc.). It is available in English, French, German and Spanish. A free sample copy or free subscription can be obtained from:

European Commission  
Directorate-General for Research  
Communication Unit  
B-1049 Brussels  
Fax (32-2) 29-58220  
E-mail: [research-eu@ec.europa.eu](mailto:research-eu@ec.europa.eu)  
Internet: <http://ec.europa.eu/research/research-eu>

## EUROPEAN COMMISSION

Directorate-General for Research  
Directorate I – Environment  
Unit I.5 – Environment – Climate Change and Environmental Risks

E-mail: [rtd-climate-change@ec.europa.eu](mailto:rtd-climate-change@ec.europa.eu)

Contact: Anastasios Kentarchos

European Commission  
Office CDMA 03/115  
B-1049 Brussels

Tel. (32-2) 29-66421  
Fax (32-2) 29-65987  
E-mail: [anastasios.kentarchos@ec.europa.eu](mailto:anastasios.kentarchos@ec.europa.eu)

### Contact:

Ulf Riebesell  
IFM-GEOMAR  
Leibniz Institute of Marine Sciences  
Düsternbrooker Weg 20  
24105 Kiel  
Germany  
E-mail: [uriebesell@ifm-geomar.de](mailto:uriebesell@ifm-geomar.de)

Jean-Pierre Gattuso  
Laboratoire d'Océanographie  
CNRS-INSU and Université Pierre et Marie Curie  
B.P. 28  
06234 Villefranche-sur-mer Cedex  
France  
E-mail: [gattuso@obs-vlfr.fr](mailto:gattuso@obs-vlfr.fr)  
[www.epoca-project.eu](http://www.epoca-project.eu)

### Design:

DITO, Monaco, Principality of Monaco

### Cover photo:

© David Luquet  
<http://www.davidluquet.com/>

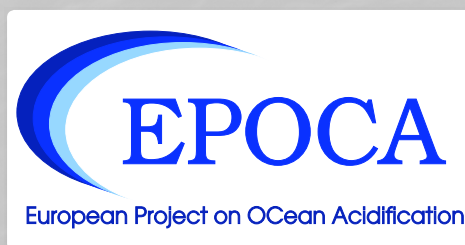

In cooperation with:

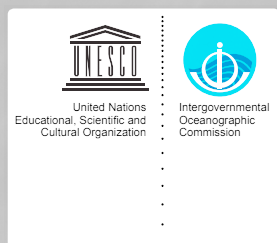

# Guide to best practices for ocean acidification research and data reporting

edited by

Ulf Riebesell<sup>1</sup>,  
Victoria J. Fabry<sup>2</sup>,  
Lina Hansson<sup>3</sup>  
and  
Jean-Pierre Gattuso<sup>4</sup>

<sup>1</sup> IFM-GEOMAR, Leibniz Institute of Marine Sciences,  
Kiel, Germany

<sup>2</sup> California State University San Marcos,  
San Marcos, USA

<sup>3</sup> Laboratoire d'Océanographie,  
CNRS-INSU and Université Pierre et Marie Curie,  
Villefranche-sur-mer, France

<sup>4</sup> Coordinator of EPOCA, Laboratoire d'Océanographie,  
CNRS-INSU and Université Pierre et Marie Curie,  
Villefranche-sur-mer, France

***EUROPE DIRECT is a service to help you find answers  
to your questions about the European Union***

Freephone number (\*):  
**00 800 6 7 8 9 10 11**

(\*) Certain mobile telephone operators do not allow access to 00 800 numbers  
or these calls may be billed

**LEGAL NOTICE:**

Neither the European Commission nor any person acting on behalf of the Commission is responsible for the use which might be made of the following information.

The views expressed in this publication are the sole responsibility of the author and do not necessarily reflect the views of the European Commission.

A great deal of additional information on the European Union is available on the Internet.  
It can be accessed through the Europa server (<http://europa.eu>).

Cataloguing data can be found at the end of this publication.

Luxembourg: Publications Office of the European Union, 2010

ISBN 978-92-79-11118-1  
ISSN 1018-5593  
doi 10.2777/58454

© European Communities, 2010  
Reproduction is authorised provided the source is acknowledged.

*Printed in Belgium*

PRINTED ON WHITE CHLORINE-FREE PAPER

## Foreword

The surface ocean currently absorbs approximately 25% of the CO<sub>2</sub> emitted to the atmosphere from human activities, especially fossil-fuel combustion and deforestation. However, due to the rapid increase of atmospheric CO<sub>2</sub> concentration since the industrial revolution, the ocean is absorbing greater amounts of CO<sub>2</sub> at increasingly rapid rates. As a result, the ocean becomes more acidic. It is estimated that during the past 250 years the seawater acidity has increased by 30%.

Acidification due to ocean uptake of carbon dioxide is likely to have serious consequences for some marine organisms and ecosystems as well as for biodiversity over this century. Therefore, research on ocean acidification goes beyond the academic curiosity. We are currently at the beginning of a journey trying to understand and quantify the rate of ocean acidification and its various ecological, biogeochemical and socio-economic impacts.

The European Union reacted fast in this new challenge and funded, under the 7<sup>th</sup> Framework for Research, the EPOCA integrated project. EPOCA (2008-2012) brings together 27 European research institutes with the aim to document changes in ocean chemistry and determine the sensitivity of marine organisms and ecosystems to ocean acidification with a focus on the Atlantic and Arctic Oceans. Since its inception, the project has been in the forefront of ocean acidification research in the international arena, also increasing awareness in the policy and public domains.

Given the imperative role of research in this domain, I welcome the present publication, as it provides necessary guidelines and standards for ocean acidification research, and thus facilitates the immense efforts undertaken by numerous research institutes worldwide, towards the understanding of this complex but highly important issue, in the years ahead.



Dr. Elisabeth Lipiatou

Head of Unit  
Climate Change and Environmental Risks Unit  
European Commission, DG Research



## Preface

Ocean acidification is an undisputed fact. The ocean presently takes up one-fourth of the carbon  $\text{CO}_2$  emitted to the atmosphere from human activities. As this  $\text{CO}_2$  dissolves in the surface ocean, it reacts with seawater to form carbonic acid, increasing ocean acidity and shifting the partitioning of inorganic carbon species towards increased  $\text{CO}_2$  and dissolved inorganic carbon, and decreased concentration of carbonate ion. Since the beginning of the industrial revolution in the 18th century, surface-ocean acidity has gone up by 30%. The current increase in ocean acidity is a hundred times faster than any previous natural change that has occurred over the last many millions of years. In the case of unabated  $\text{CO}_2$  emissions the level of ocean acidity will increase to three times the preindustrial level by the end of this century. Recovery from this large and rapid perturbation will require tens of thousands of years. While our understanding of the possible consequences of ocean acidification is still rudimentary, both the scientific community and the society at large are increasingly concerned about the possible risks associated with ocean acidification for marine organisms and ecosystems.

Over the past few years, several high profile reports have highlighted the urgent need to better understand the effects of changes in carbonate chemistry on marine organisms and ecosystems. Research in this field was limited to a few groups around the world until recently but the number of scientists involved in ocean acidification research has been rapidly rising over the past few years. New coordinated national programmes are being initiated and will further augment the research efforts in this area. Students, young researchers, and established scientists inexperienced with the intricacies of the seawater carbonate chemistry will enter the field. At first sight, the experimental and intellectual challenges of conducting  $\text{CO}_2$ /pH perturbation experiments may appear trivial. pH seems easy to measure and  $\text{CO}_2$  enrichment simple and straightforward. However, the reliable characterisation and manipulation of the carbonate system involves good analytical skills and measuring facilities and continuous monitoring of seawater chemistry in the field and during experimentation. The predictive power of field surveys and the robustness of results from perturbation experiments critically depend on proper sampling and experimental protocols, and sound statistical data analysis. The relevant expertise is available in many laboratories around the world and efforts are being made, both in the framework of national and international programmes and on a scientist by scientist basis, to pass the expertise on to those interested to enter the field. We encourage funding agencies, research coordinators, and experienced scientists to further promote and facilitate the exchange of expertise relevant to ocean acidification research.

The initial learning curve in this new and rapidly growing research field is steep. Simple experiments will provide new insights and give straightforward answers. As more results come in, the picture will complicate. Some results may lead to conflicting conclusions. The reasons for this can be manifold. Different strains or species may respond differently. The sensitivity to ocean acidification of recent isolates may differ from that of clones kept in culture over years or decades. The duration of acclimation or the rate at which the carbonate system is manipulated may

also lead to different results. Species interactions may alter individual responses. Community and ecosystem changes unrelated to ocean acidification may disguise or amplify the sensitivity to ocean acidification. Environmental variables other than carbonate chemistry may also modify the response to ocean acidification. However, some contradictory responses may also result from inappropriate experimental protocols, experimental artefacts, misinterpretations of the data, and inconsistent model parameterisations. To be able to distinguish these from genuine biological and biogeochemical disparity it will be crucially important for our community to apply rigorous scientific standards in our research, have access to full and detailed documentation of the analytical, experimental, statistical, and modeling approaches as well as the original data and model parameterisations.

As this new and pressing field of marine research gains momentum, many in our community, including representatives of coordinated research projects, international scientific organisations, funding agencies, and scientists in this field felt the need to provide guidelines and standards for ocean acidification research. To initiate this process, the European Project on Ocean Acidification (EPOCA) and the Intergovernmental Oceanographic Commission (IOC) jointly invited over 40 leading scientists active in ocean acidification research to a meeting at the Leibniz Institute of Marine Science (IFM-GEOMAR) in Kiel, Germany on 19-21 November 2008. To keep this initiative focused and efficient, its scope was limited to research areas dealing with the recent past, present and future of ocean acidification. We hope this initiative will stimulate similar activities in research foci that are not covered in this guide, including palaeoceanography.

At the Kiel meeting, which was sponsored by EPOCA, IOC, the Scientific Committee on Oceanic Research (SCOR), the U.S. Ocean Carbon and Biogeochemistry Project (OCB) and the Kiel Excellence Cluster “The Future Ocean”, the basic structure and contents of the guide was agreed upon and an outline was drafted. In the following months, the workshop participants and additional invited experts prepared draft manuscripts for each of the sections, which were subsequently reviewed by independent experts and revised according to their recommendations. Starting 15 May 2009, the guide was made publicly available for an open community review, which resulted in the final document presented here. It is envisioned to revisit and possibly revise the guide to accommodate new developments in the field in a few years time.

We are very grateful to all colleagues who have committed their precious time to the preparation of this guide as lead and contributing authors, and reviewers. We thank the editors of the four parts of this guide, Victoria J. Fabry, Richard A. Feely, Marion Gehlen, Debora Iglesias-Rodriguez, Kitack Lee, Jens Nejstgaard, Mike Thorndyke and Bronte Tilbrook for their assistance putting the guide together. We also thank Anastasios Kentarchos from the European Commission for his assistance for the publication of this guide.

On behalf of the writing team,

Ulf Riebesell, Victoria J. Fabry, Lina Hansson and Jean-Pierre Gattuso (co-editors)



## Table of contents

List of acronyms and abbreviations .....	11
Contributing authors .....	13
1 The carbon dioxide system in seawater: equilibrium chemistry and measurements .....	17
1.1 Introduction .....	17
1.2 Basic chemistry of carbon dioxide in seawater .....	20
1.3 The definition and measurement of pH in seawater .....	27
1.4 Implications of other acid-base equilibria in seawater on seawater alkalinity .....	31
1.5 Choosing the appropriate measurement techniques .....	32
1.6 Conclusions and recommendations .....	38
1.7 References .....	39
2 Approaches and tools to manipulate the carbonate chemistry .....	41
2.1 Introduction .....	41
2.2 Approaches and methodologies .....	41
2.3 Strengths and weaknesses .....	45
2.4 Potential pitfalls and suggestions for improvements .....	46
2.5 Data reporting .....	50
2.6 Recommendations for standards and guidelines .....	51
2.7 References .....	51
3 Atmospheric CO <sub>2</sub> targets for ocean acidification perturbation experiments .....	53
3.1 Introduction .....	53
3.2 Approaches and methodologies .....	55
3.3 Strengths and weaknesses .....	62
3.4 Potential pitfalls .....	62
3.5 Suggestions for improvements .....	63
3.6 Data reporting .....	63
3.7 Recommendations for standards and guidelines .....	63
3.8 References .....	64
4 Designing ocean acidification experiments to maximise inference .....	67
4.1 Introduction .....	67
4.2 The sampling universe .....	67
4.3 Experimental design .....	69
4.4 Statistical analyses .....	72
4.5 Recommended texts for further reading .....	79
4.6 Recommendations for standards and guidelines .....	79
4.7 References .....	79
5 Bioassays, batch culture and chemostat experimentation .....	81
5.1 Introduction .....	81
5.2 Approaches and methodologies .....	82
5.3 Strengths and weaknesses .....	90
5.4 Potential pitfalls .....	91
5.5 Suggestions for improvements .....	91
5.6 Data reporting .....	92
5.7 Recommendations for standards and guidelines .....	92
5.8 References .....	92

6	Pelagic mesocosms .....	95
6.1	Introduction .....	95
6.2	Approaches and methodologies .....	97
6.3	Strengths and weaknesses .....	104
6.4	Potential pitfalls and suggestions for improvements .....	104
6.5	Data reporting .....	107
6.6	Recommendations for standards and guidelines .....	108
6.7	References .....	108
7	Laboratory experiments and benthic mesocosm studies .....	113
7.1	Introduction .....	113
7.2	Approaches and methodologies .....	114
7.3	Strengths and weaknesses .....	115
7.4	Potential pitfalls .....	117
7.5	Suggestions for improvements .....	119
7.6	Data reporting .....	119
7.7	Recommendations for standards and guidelines .....	120
7.8	References .....	121
8	<i>In situ</i> perturbation experiments: natural venting sites, spatial/temporal gradients in ocean pH, manipulative <i>in situ</i> p(CO <sub>2</sub> ) perturbations .....	123
8.1	Introduction .....	123
8.2	Approaches and methodologies .....	126
8.3	Strengths and weaknesses .....	129
8.4	Potential pitfalls .....	132
8.5	Suggestions for improvement .....	133
8.6	Data reporting .....	133
8.7	Recommendations for standards and guidelines .....	133
8.8	References .....	134
9	Studies of acid-base status and regulation .....	137
9.1	Introduction .....	137
9.2	Fundamentals of acid-base regulation .....	138
9.3	Measurement of pH, total CO <sub>2</sub> and non-bicarbonate buffer values .....	141
9.4	Compartmental measurements: towards a quantitative picture .....	156
9.5	Overall suggestions for improvements .....	159
9.6	Data reporting .....	160
9.7	References .....	160
10	Studies of metabolic rate and other characters across life stages .....	167
10.1	Introduction .....	167
10.2	Definition of a frame of reference: studying specific characters across life stages .....	167
10.3	Approaches and methodologies: metabolic studies .....	172
10.4	Study of early life stages .....	175
10.5	Techniques for oxygen analyses .....	176
10.6	Overall suggestions for improvements .....	177
10.7	Data reporting .....	177
10.8	Recommendations for standards and guidelines .....	177
10.9	References .....	178
11	Production and export of organic matter .....	181
11.1	Introduction .....	181
11.2	Approaches and methodologies .....	182
11.3	Strengths and weaknesses .....	186

11.4	Potential pitfalls.....	188
11.5	Suggestions for improvements .....	191
11.6	Data reporting.....	191
11.7	Recommendations for standards and guidelines .....	194
11.8	References .....	195
12	Direct measurements of calcification rates in planktonic organisms.....	201
12.1	Introduction .....	201
12.2	Approaches and methodologies.....	201
12.3	Strengths and weaknesses.....	206
12.4	Potential pitfalls.....	208
12.5	Suggestions for improvement.....	208
12.6	Data reporting.....	208
12.7	Recommendations for standards and guidelines .....	209
12.8	References .....	209
13	Measurements of calcification and dissolution of benthic organisms and communities.....	213
13.1	Introduction .....	213
13.2	Approaches and methodologies.....	213
13.3	Calcification.....	214
13.4	Dissolution.....	224
13.5	Strengths and weaknesses.....	226
13.6	Potential pitfalls.....	227
13.7	Suggestions for improvement.....	227
13.8	Data reporting.....	227
13.9	Recommendations for standards and guidelines .....	228
13.10	References .....	228
14	Modelling considerations .....	233
14.1	Introduction .....	233
14.2	Approaches and methodologies.....	234
14.3	Strengths and weaknesses.....	236
14.4	Potential pitfalls.....	237
14.5	Suggestions for improvements .....	238
14.6	Data reporting.....	239
14.7	Recommendations for standards and guidelines .....	239
14.8	References .....	239
15	Safeguarding and sharing ocean acidification data.....	243
15.1	Introduction .....	243
15.2	Sharing ocean acidification data.....	243
15.3	Safeguarding ocean acidification data .....	245
15.4	Harmonising ocean acidification data and metadata .....	246
15.5	Disseminating ocean acidification data and metadata .....	247
15.6	Reporting data and metadata .....	248
15.7	Avoiding pitfalls and addressing challenges .....	255
15.8	Recommendations for standards and guidelines .....	257
15.9	References .....	258



## List of acronyms and abbreviations

AFM: Atomic Force Microscopy  
AM: acetoxymethyl ester  
AMR: Active Metabolic Rate  
ANOSIM: Analysis of Similarity  
ANOVA: Analysis of Variance  
AS: Aerobic Scope  
 $A_T$ : total alkalinity  
ATP: Adenosine Triphosphate

BACI: Before-After Control-Impact design  
BATS: Bermuda Atlantic Time-series Study  
BCO-DMO Ocean Carbon and Biogeochemistry Data Management Office  
BODC: British Oceanographic Data Centre

CAS: Chemical Abstracts Service  
CCC flags: Carbonate Chemistry Computation flags  
CCMs: CO<sub>2</sub>-Concentrating Mechanisms  
CDIAC: Carbon Dioxide Information Analysis Centre  
CEPEX: Controlled Ecosystem Pollution Experiment  
CIESM: Mediterranean Science Commission  
CPU: Central Processing Unit  
CRM: Certified Reference Material  
CTD: Conductivity, Temperature, Depth sensor  
CV: Coefficient of Variability

DAPI: 4',6'-diamidino-2-phenylindole  
DCMI: Dublin Core Metadata Initiative  
DIC: Dissolved Inorganic Carbon  
DIF: Directory Interchange Format  
DIW: Distilled Water  
DMSO: Dimethyl sulfoxide  
DOC: Dissolved Organic Carbon  
DOIs: Digital Object Identifiers  
DOM: Dissolved Organic Matter  
DON: Dissolved Organic Nitrogen

EDTA: ethylenediaminetetraacetic acid  
EGTA: ethylene glycol tetraacetic acid  
EMBL-EBI: European Molecular Biology Laboratory-European Bioinformatics Institute  
ENSO: El Niño-Southern Oscillation  
ERMS: European Register of Marine Species  
ESSD: Earth System Science Data

FACE: Free Air CO<sub>2</sub> Enrichment  
FDA: diacetate ester  
FET pH sensors: Field Effect Transistor pH sensors  
FGDC: Federal Geographic Data Committee  
FIRE: Fluorescence Induction and Relaxation  
FOCE: Free Ocean CO<sub>2</sub> Enrichment  
FRRF: Fast Repetition Rate Fluorescence

GC: Gas Chromatography  
GE-BICH: IODE's Group of Experts on Biological and Chemical Data Management and Exchange Practices  
GEOSS: Global Earth Observation System of Systems  
GFP: Green Fluorescent Protein  
GLODAP: Global Ocean Data Analysis Project  
GM: Geometric Mean  
GTC: Gigaton of carbon

<sup>1</sup>H-MRSI: <sup>1</sup>H Magnetic Resonance Spectroscopic Imaging  
HEPES: 4-(2-hydroxyethyl)-1-piperazineethanesulfonic acid  
HNLC: High-Nutrient, Low-Chlorophyll  
HOT: Hawaii Ocean Time-series

ICES: International Council for the Exploration of the Sea

ICP-OES: Inductively Coupled Plasma-Optical Emission Spectroscopy

ICSU: International Council for Science

IEPA: 2-imidazol-1-yl-3-ethoxycarbonyl-propionate

IGBP: International Geosphere-Biosphere Programme  
IMBER: Integrated Marine Biogeochemistry and Ecosystem Research

IOC-UNESCO: Intergovernmental Oceanographic Commission of the United Nations Educational, Scientific and Cultural Organization

IODE: International Oceanographic Data Exchange programme

ICPOES : Inductively Coupled Plasma Optical Emission Spectroscopy

IPCC: Intergovernmental Panel on Climate Change

ISFET: Ion-Sensitive Field Effect Transistor

ITIS: International Taxonomy Information System

IUPAC: International Union of Pure and Applied Chemistry

JGOFS: Joint Global Ocean Flux Study

LSID: Life Science Identifiers

MANOVA: Multivariate Analysis of Variance

MARS: Monterey Accelerated Research System

MDS: Multidimensional Scaling

MERL: Marine Ecosystem Research Laboratory

MIMS: Membrane-Inlet Mass Spectrometry

ML: Maximum Likelihood estimation

MMR: Maximum Metabolic Rate

MRI: Magnetic Resonance Imaging

MRS: Magnetic Resonance Spectroscopy

MS: Mass Spectrometry

NADPH: Nicotinamide adenine dinucleotide phosphate

NBS: US National Bureau of Standards

NERC: Natural Environment Research Council

NMR: Nuclear Magnetic Resonance

NODC: National Oceanographic Data Centre

OBIS: Ocean Biogeographic Information System

OCLT: Oxygen- and Capacity-Limited Thermal Tolerance

OCMIP: Ocean Carbon-Cycle Model Intercomparison Project

OECD: Organisation for Economic Co-operation and Development

OLS: Ordinary Least Squares

OM: organic matter

p(CO<sub>2</sub>): partial pressure of CO<sub>2</sub> in seawater

PAL: Preindustrial Atmospheric Levels

PAM: Pulse Amplitude Modulation

PANGAEA: Publishing Network for Geoscientific and Environmental Data

PaP: Pump and Probe

PCA: Principal Components Analysis

PFT models: Plankton Functional Types models

PIC: Particulate Inorganic Carbon

POC: Particulate Organic Carbon

POM: Particulate Organic Matter

PON: Particulate Organic Nitrogen

PQ: Photosynthetic Quotient

PSII: Photosystem II

RMSE: Root Mean Square Error

ROV: Remotely Operated Vehicle

RQ: Respiratory Quotient

RuBisCO: Ribulose-1,5-bisphosphate carboxylase oxygenase

SCOR: Scientific Committee on Oceanic Research

SDA: Specific Dynamic Action

SEM: Scanning Electron Microscopy

SI: *Système International d'Unités* (International System of Units)

SISMER: *Systèmes d'Informations Scientifiques pour la Mer*

SMR: Standard Metabolic Rate

SOP: Standard Operating Procedure

SRES: Special Report on Emissions Scenarios

TDWG: Taxonomic Database Working Group

TEP: Transparent Exopolymeric Particles

URL: Uniform Resource Locator

URN: Uniform Resource Name

UUID: Universally Unique Identifier

VSI: Vertical Scanning Interferometry

WDC-MARE: World Data Center for Marine Environmental Sciences

WDC: World Data Centre

WoRMS: World Register of Marine Species

WRE scenario (Wigley, Richels and Edmunds)

# Guide to best practices for ocean acidification research and data reporting

## Contributing authors

### Andreas Andersson

Bermuda Institute of Ocean Sciences  
17 Biological Station  
St. George's GE01  
Bermuda  
andreas.andersson@bios.edu

### William M. Balch

Bigelow Laboratory for Ocean Sciences  
POB 475  
W. Boothbay Harbor, ME 045750  
USA  
bbalch@bigelow.org

### Joana Barcelos e Ramos

University of the Azores  
Campus de Angra do Heroísmo  
Terra-Chã  
PT - 9701-851 Angra do Heroísmo  
Azores  
Portugal  
joanabr@uac.pt

### James P. Barry

Monterey Bay Aquarium Research Institute  
7700 Sandholdt Road  
Moss Landing, CA 95039  
USA  
barry@mbari.org

### Ulf Bickmeyer

Alfred Wegener Institute for Polar and Marine Research  
Am Handelshafen 12,  
D-27570 Bremerhaven  
Germany  
Ulf.Bickmeyer@awi.de

### Jeremy Blackford

Plymouth Marine Laboratory  
Prospect Place  
Plymouth, PL13DH  
UK  
jcb@pml.ac.uk

### Markus Bleich

Institute of Physiology  
Christian-Albrechts-University  
Olshausenstraße 40  
24098 Kiel  
Germany  
m.bleich@physiologie.uni-kiel.de

### Christian Bock

Alfred Wegener Institute for Polar and Marine Research  
Am Handelshafen 12,  
D-27570 Bremerhaven  
Germany  
christian.bock@awi.de

### Colin Brownlee

Marine Biological Association  
Citadel Hill  
Plymouth PL1 2PB  
UK  
cbr@MBA.ac.uk

### Andrew G. Dickson

Scripps Institution of Oceanography  
University of California, San Diego  
9500 Gilman Drive  
La Jolla, CA 92093-0244  
USA  
adickson@ucsd.edu

### Scott C. Doney

Marine Chemistry and Geochemistry Dept.  
Woods Hole Oceanographic Institution  
Woods Hole, MA 02543  
USA  
sdoney@whoi.edu

### Sam Dupont

Department of Marine Ecology  
University of Gothenburg  
Sven Lovén Centre for Marine Sciences  
Kristineberg, 45034  
Sweden  
sam.dupont@marecol.gu.se

**Anja Engel**

Alfred Wegener Institute for Polar and Marine Research  
Am Handelshafen 12,  
D-27570 Bremerhaven  
Germany  
anja.engel@awi.de

**Victoria J. Fabry**

California State University San Marcos  
San Marcos, CA 92096-0001  
USA  
fabry@csusm.edu

**Kunshan Gao**

State Key Laboratory of Marine Environmental Science  
Xiamen University  
Daxue Road 182 (HAIYANG-LOU)  
Xiamen, Fujian 361005  
China  
ksgao@xmu.edu.cn

**Jean-Pierre Gattuso**

Laboratoire d'Océanographie  
CNRS-INSU and Université Pierre et Marie Curie  
B.P. 28  
06234 Villefranche-sur-mer Cedex  
France  
gattuso@obs-vlfr.fr

**Marion Gehlen**

Laboratoire des Sciences du Climat et de  
l'Environnement  
LSCE/IPSL  
L'Orme des Merisiers, Bât. 712  
91191 Gif-sur-Yvette cedex  
France  
marion.gehlen@lscce.ipsl.fr

**Richard Geider**

Department of Biological Sciences  
University of Essex  
Colchester CO4 3SQ  
UK  
geider@essex.ac.uk

**Jason M. Hall-Spencer**

Marine Institute  
University of Plymouth  
Plymouth PL4 8AA  
UK  
jason.hall-spencer@plymouth.ac.uk

**Lina Hansson**

Laboratoire d'Océanographie  
CNRS-INSU and Université Pierre et Marie Curie  
B.P. 28  
06234 Villefranche-sur-mer Cedex  
France  
hansson@obs-vlfr.fr

**Jon Havenhand**

Department of Marine Ecology – Tjärnö  
University of Gothenburg,  
45296 Strömstad  
Sweden  
jon.havenhand@marecol.gu.se

**Leslie Alan Hook**

NASA DAAC  
Environmental Sciences Division  
Oak Ridge National Laboratory  
Oak Ridge, TN 37831-6407  
USA  
hookla@ornl.gov

**David A. Hutchins**

Department of Biological Sciences  
University of Southern California  
3616 Trousdale Parkway  
Los Angeles, CA 90089  
USA  
dahutch@usc.edu

**Chris Langdon**

Rosenstiel School of Marine and Atmospheric Science  
University of Miami  
4600 Rickenbacker Causeway  
Miami, FL 33149  
USA  
clangdon@rsmas.miami.edu



**Julie LaRoche**  
IFM-GEOMAR  
Leibniz Institute of Marine Sciences  
Düsternbrooker Weg 20  
24105 Kiel  
Germany  
jlaroche@ifm-geomar.de

**Cindy Lee**  
School of Marine and Atmospheric Sciences  
Stony Brook University  
Stony Brook, NY 11794-5000  
USA  
cindylee@sunysb.edu

**Kitack Lee**  
School of Environmental Science and Engineering  
Pohang University of Science and Technology Pohang  
South Korea  
ktl@postech.ac.kr

**Roy Lowry**  
BODC  
Joseph Proudman Building  
6 Brownlow Street  
Liverpool L3 5DA  
UK  
rkl@bodc.ac.uk

**Frank Melzner**  
IFM-GEOMAR  
Leibniz Institute of Marine Sciences  
Düsternbrooker Weg 20  
24105 Kiel  
Germany  
fmelzner@ifm-geomar.de

**Basile Michaelidis**  
Faculty of Sciences  
School of Biology  
Aristotle University of Thessaloniki  
Thessaloniki 54124  
Greece  
michaeli@bio.auth.gr

**Gwenaëlle Moncoiffé**  
British Oceanographic Data Centre (BODC)  
Joseph Proudman Building  
6 Brownlow Street  
Liverpool L3 5DA  
UK  
gmon@bodc.ac.uk

**Jens C. Nejtgaard**  
Uni Environment  
Uni Research AS  
Thormøhlensgt. 49B  
POBox 7810  
N-5020 Bergen  
Norway  
jens.nejtgaard@uni.no

**Anne-Marin Nisumaa**  
Laboratoire d'Océanographie  
CNRS-INSU and Université Pierre et Marie Curie  
B.P. 28  
06234 Villefranche-sur-mer Cedex  
France  
nisumaa@obs-vlfr.fr

**Andreas Oschlies**  
IFM-GEOMAR  
Leibniz Institute of Marine Sciences  
Düsternbrooker Weg 20  
24105 Kiel  
Germany  
aoschlies@ifm-geomar.de

**Stéphane Pesant**  
Centre for Marine Environmental Sciences  
University of Bremen  
Leobener Strasse  
D-28359 Bremen  
Germany  
spesant@marum.de

**Benjamin Pfeil**  
Bjerknes Centre for Climate Research University of  
Bergen  
Allégaten 70  
NO-5007 Bergen  
Norway  
Benjamin.Pfeil@bjerknes.uib.no

**Gian-Kasper Plattner**

Climate and Environmental Physics  
Physics Institute  
University of Bern  
Sidlerstrasse 5  
3012 Bern  
Switzerland  
plattner@climate.unibe.ch

**Hans-Otto Pörtner**

Alfred Wegener Institute for Polar and Marine Research  
Am Handelshafen 12,  
D-27570 Bremerhaven  
Germany  
hans.poertner@awi.de

**Gerry P. Quinn**

School of Life & Environmental Sciences  
Deakin University  
PO Box 423  
Warrnambool, VIC 3280  
Australia  
gerry.quinn@deakin.edu.au

**Ulf Riebesell**

IFM-GEOMAR  
Leibniz Institute of Marine Sciences  
Düsternbrooker Weg 20  
24105 Kiel  
Germany  
uriebesell@ifm-geomar.de

**Björn Rost**

Alfred Wegener Institute for Polar and Marine Research  
Am Handelshafen 12,  
D-27570 Bremerhaven  
Germany  
Bjoern.Rost@awi.de

**Rüdiger Röttgers**

Institute for Coastal Research  
GKSS Research Center Geesthacht  
D-21502 Geesthacht  
Germany  
ruediger.roettgers@gkss.de

**Franz-Josef Sartoris**

Alfred Wegener Institute for Polar and Marine Research  
Am Handelshafen 12,  
D-27570 Bremerhaven  
Germany  
Franz-Josef.Sartoris@awi.de

**Kai G. Schulz**

IFM-GEOMAR  
Leibniz Institute of Marine Sciences  
Düsternbrooker Weg 20  
24105 Kiel  
Germany  
kschulz@ifm-geomar.de

**Daniela Storch**

Alfred Wegener Institute for Polar and Marine Research  
Am Handelshafen 12,  
D-27570 Bremerhaven  
Germany  
Daniela.Storch@awi.de

**Frede Thingstad**

Department of Biology  
University of Bergen  
N-5020 Bergen, Norway  
Frede.Thingstad@bio.uib.no

**Mike Thorndyke**

Royal Swedish Academy of Sciences  
University of Gothenburg  
Sven Lovén Centre for Marine Sciences  
Kristineberg, 45034  
Sweden  
Mike.Thorndyke@marecol.gu.se

**Toby Tyrrell**

National Oceanography Centre  
University of Southampton  
Southampton, SO14 3ZH  
UK  
Toby.Tyrrell@soton.ac.uk

**Steve Widdicombe**

Plymouth Marine Laboratory  
Prospect Place  
Plymouth, PL1 3DH  
UK  
swi@pml.ac.uk

## 1 The carbon dioxide system in seawater: equilibrium chemistry and measurements

Andrew G. Dickson

Scripps Institution of Oceanography, University of California, USA

### 1.1 Introduction

The world's oceans can be thought of as a dilute solution of sodium bicarbonate (together with other acid-base species at still lower concentrations) in a saltwater background. In the surface waters of the North Atlantic, for example, the concentration of total dissolved inorganic carbon (the sum of the concentrations of the three coexisting species: bicarbonate ion, carbonate ion, and unionised dissolved carbon dioxide) is only about 2 mmol kg<sup>-1</sup>. About 90% of this is present as bicarbonate ion, the proportion of carbonate ion is about a factor of 10 less (~10%), and that of unionised carbon dioxide yet another factor of 10 less (<1%). As a result of the equilibria between these various species (see below), seawater is buffered (weakly) with respect to changes in hydrogen ion (present at much lower concentrations: <10<sup>-8</sup> μmol kg<sup>-1</sup>).

Over the past twenty years, accurate measurement of the seawater carbon dioxide system has become a high priority for scientists who have worked to understand just how much of the carbon dioxide (CO<sub>2</sub>) created by man's activities has ended up in the ocean, where it is distributed, and how it has changed the chemistry of the oceans. The chemical changes associated with the increase of CO<sub>2</sub> in the oceans are often referred to as *ocean acidification*. As we work to design suitable experiments to understand the biological and ecological consequences of such changes, it is important that the chemistry of CO<sub>2</sub> be well characterised in the various laboratory experiments and field observations that are undertaken. Achieving this requires an understanding of the basic solution chemistry underlying ocean acidification, as well as of the relative merits of the various analytical techniques available to the investigator.

Unfortunately – from the point of view of someone desiring simplicity – in addition to carbon dioxide there are other acid-base systems in seawater that complicate things, particularly in systems that are not typical of the open surface ocean, with its low nutrient levels and relatively low amounts of dissolved organic material. The approach I shall take in this chapter is to introduce first a somewhat simplified view of acid-base chemistry in seawater involving only the primary seawater acid-base systems: carbonic acid, boric acid and water. These will be discussed in some detail, and used to introduce the classical oceanographic analytical parameters for carbon dioxide studies in seawater: total dissolved inorganic carbon, total alkalinity, pH, and p(CO<sub>2</sub>) – the partial pressure of carbon dioxide that is in equilibrium with a water sample (Box 1.1). The concept of calcium carbonate saturation state will also be introduced.

Once this basic seawater chemistry has been presented – and assimilated – it will be appropriate to revisit a number of these topics and to introduce further complexity, so as to clarify how these various concepts can be applied appropriately in the seawater systems that are of interest to investigators in ocean acidification. Finally, I shall present a brief discussion of some of the current techniques available for the measurement of the various parameters of the seawater carbon dioxide system, and will indicate their advantages and disadvantages. The advantages and disadvantages of using alternate combinations of parameters to provide a complete description of the composition of a particular seawater sample will also be discussed.

As will become clear, at this time it is not as straightforward as one might wish to characterise the state of a particular seawater sample's carbonate chemistry and to assign a well-constrained measurement uncertainty. Investigators who wish to do high quality work in ocean acidification, but who have little previous experience in seawater CO<sub>2</sub> measurements, would do well to collaborate with a scientist with experience in this area and who has access to a working laboratory that can perform the necessary measurements with the required quality.

### Box 1.1: Terminology and units for parameters relevant to the carbonate system

Hans-Otto Pörtner, Andrew Dickson and Jean-Pierre Gattuso

Research in ocean acidification brings together various scientific disciplines such as chemistry, geology, biogeochemistry, ocean physics and various sub-disciplines of biology and ecology (biological oceanography, marine ecology and ecological physiology, biochemistry, physiological chemistry and molecular biology). Each of these disciplines generally investigates ocean acidification from its own point of view, building on its own traditions with the goal of providing the highest possible accuracy under the constraints of each field. Ideally, efficient communication should use a unified set of terms and units in scientific presentations, discussions and publications and when differences exist, they must be clearly documented and understood. A large number of terms and units are used to describe the physicochemical properties of the carbonate system in seawater and in the biological material and fluids that interact with seawater (Table). Marine chemistry uses them to quantify changes in seawater acid-base composition. Acid-base physiology uses similar terms to estimate the quantities of protons or base equivalents moving between water and organism as well as between body compartments causing changes in body fluid composition (e.g. Pörtner *et al.*, 1991). The aim of this box is to alert readers to parameters (e.g. pH, dissolved inorganic carbon) that are defined differently in marine chemistry (see chapter 1) and physiology (see chapter 9) and to describe the main terms and units used in this guide.

pH is the parameter that causes most difficulties. Marine chemistry has developed the total hydrogen ion concentration scale. It requires buffers prepared in synthetic seawater for calibration (Hansson, 1973; Dickson *et al.*, 2007). This scale includes the effect of sulfate ion in its definition. From a physiological perspective, the use of a free hydrogen ion concentration scale would be more appropriate than the total scale as it does not include sulfate protonation in its definition. It is possible to convert a pH value from the total scale to the free scale and vice versa (Zeebe & Wolf-Gladrow, 2001) in seawater of a known salinity, and software tools are available to achieve this (Lavigne & Gattuso, 2010). The free scale could also be used to express pH of the extracellular fluids of marine invertebrates. However, neither the total scale nor the free scale can be used straightforwardly for pH determinations in intracellular fluids and in extracellular fluids of vertebrates, which have ionic strengths of about one third of that of seawater. The conventional NBS pH scale is therefore commonly used in physiology for such measurements.

The sum of the concentrations of all inorganic carbon species is termed “total dissolved inorganic carbon” (DIC or  $C_T$ ) in the field of marine chemistry and “total  $CO_2$ ” ( $C_{CO_2}$ ) in the field of physiology. These terms are not always synonymous, especially in body fluids where  $C_{CO_2}$  may also include inorganic  $CO_2$  species bound to protein. Furthermore, different (though related) titration procedures are used to determine total alkalinity (by use of strong acid) in seawater and titratable acid(ity) (by use of strong base) in physiological fluids like urine. In tissues and blood, the  $CO_2$ /bicarbonate buffer system is distinguished from non-bicarbonate buffers, when analysing the “titration” of the latter by accumulating  $CO_2$ , by metabolic influences, or during proton-equivalent ion exchange.

### References cited:

- Dickson A. G., Sabine C. L. & Christian J. R. (Eds.), 2007. Guide to best practices for ocean CO<sub>2</sub> measurements. *PICES Special Publication* 3: 1-191.
- Hansson I., 1973. A new set of pH-scales and standard buffers for sea water. *Deep-Sea Research* 20, 479-491
- Lavigne H. & Gattuso J.-P., 2010. seacarb: seawater carbonate chemistry with R. R version 2.3.3. <http://cran-project.org/package=seacarb>.
- Pörtner H.-O., Andersen N. A. & Heisler, N. 1991. Proton equivalent ion transfer in *Sipunculus nudus* as a function of ambient oxygen tension: relationships with energy metabolism. *Journal of Experimental Biology* 156:21-39.
- Zeebe R. E. & Wolf-Gladrow D. A., 2001. *CO<sub>2</sub> in seawater: equilibrium, kinetics, isotopes*. 346 p. Amsterdam: Elsevier.

**Table:** Main parameters describing the physicochemistry of seawater and body fluids and their differences in the fields of marine chemistry and physiology. The notation and units used in this guide are also shown. Alternate notations or units are given in parentheses.

Parameter	Marine chemistry		Physiology	
	Notation	Unit	Notation	Unit
pH <sup>(1)</sup>	Total scale	-	NBS or NIST scale <sup>(2)</sup>	-
Partial pressure of CO <sub>2</sub>	p(CO <sub>2</sub> ) (pCO <sub>2</sub> , Pco <sub>2</sub> , p(CO <sub>2</sub> ))	μatm	Pco <sub>2</sub>	kPa (mm Hg, Torr, μatm)
CO <sub>2</sub> solubility	K <sub>0</sub>	mol kg <sup>-1</sup> atm <sup>-1</sup>	αCO <sub>2</sub>	mmol l <sup>-1</sup> mm Hg <sup>-1</sup> (kPa <sup>-1</sup> )
Dissolved inorganic carbon or total CO <sub>2</sub>	DIC (C <sub>T</sub> , ΣCO <sub>2</sub> , Tco <sub>2</sub> )	mol kg <sup>-1</sup>	Cco <sub>2</sub>	mol l <sup>-1</sup>
Bicarbonate concentration	[HCO <sub>3</sub> <sup>-</sup> ]	mol kg <sup>-1</sup>	[HCO <sub>3</sub> <sup>-</sup> ]	mol l <sup>-1</sup>
Carbonate concentration	[CO <sub>3</sub> <sup>2-</sup> ]	mol kg <sup>-1</sup>	[CO <sub>3</sub> <sup>2-</sup> ]	mol l <sup>-1</sup>
Ammonium concentration	[NH <sub>4</sub> <sup>+</sup> ]	mol kg <sup>-1</sup>	[NH <sub>4</sub> <sup>+</sup> ]	mol l <sup>-1</sup>
Total alkalinity	A <sub>T</sub> (TA, AT, ALK)	mol kg <sup>-1</sup>	-	-

<sup>1</sup> Whenever a pH is defined, it is necessary to remember that it implicitly is based on a concentration unit, for hydrogen ion, although the pH value itself has the dimension 1.

<sup>2</sup> The free scale can be a suitable alternative.

## 1.2 Basic chemistry of carbon dioxide in seawater

### 1.2.1 Introduction

Seawater is unique among natural waters in that its relative composition is well defined (see e.g. Millero *et al.*, 2008) and dominated (>99.3% by mass) by a fairly limited number of major ions (Figure 1.1). The various acid-base species discussed in this chapter are in the remaining 0.7%, with carbonic acid and boric acid species predominating. As we shall see, this distinction between the *major* ions, that can be considered to make up a background ionic medium, and the various reacting species, that are present at relatively low concentrations, is an important convenience when discussing acid-base chemistry in seawater.

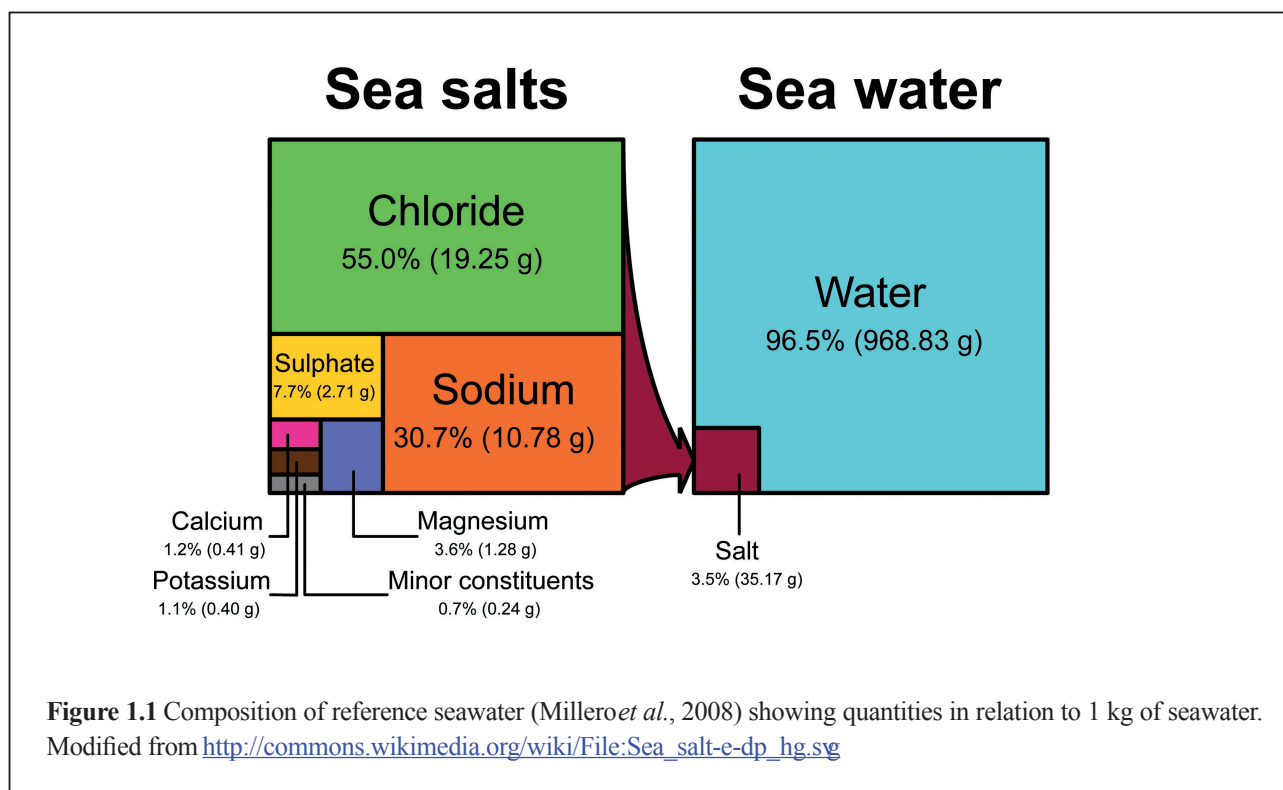

### 1.2.2 Acid-base equilibria in seawater

When carbon dioxide dissolves in water, it hydrates to yield carbonic acid,  $\text{H}_2\text{CO}_3$ . This reaction is slow relative to the ionisation of  $\text{H}_2\text{CO}_3$  and it is possible to distinguish between simple dissolved carbon dioxide,  $\text{CO}_2(\text{aq})$ , and the hydrated species,  $\text{H}_2\text{CO}_3$  (see e.g. Soli & Byrne, 2002). This kinetic process is relevant in some physiological systems and is catalysed by the enzyme carbonic anhydrase. At equilibrium, the concentration of carbonic acid,  $[\text{H}_2\text{CO}_3]$ , is only about 1/1000 of the concentration of dissolved carbon dioxide,  $[\text{CO}_2(\text{aq})]$  and has no special significance to the acid-base equilibria since both are uncharged (Butler, 1998). Here the total concentration of the two unionised species:  $[\text{H}_2\text{CO}_3] + [\text{CO}_2(\text{aq})]$ , will be abbreviated as the concentration of the hypothetical aqueous species  $\text{CO}_2^*$ :  $[\text{CO}_2^*]$ .<sup>1</sup> In acid solutions ( $\text{pH} < 5$ )  $\text{CO}_2^*$  is the dominant carbon dioxide species in solution, however at higher pHs it ionises to form bicarbonate ( $\text{HCO}_3^-$ ) and carbonate ( $\text{CO}_3^{2-}$ ) ions.

<sup>1</sup> This corresponds to defining the standard states of  $\text{CO}_2(\text{aq})$  and of  $\text{H}_2\text{CO}_3$  using the so-called *hydrate convention* (Pitzer & Brewer, 1961).

Thus when carbon dioxide dissolves in seawater it can be considered to react with the water in accordance with the following series of chemical equilibria (Figure 1.2):

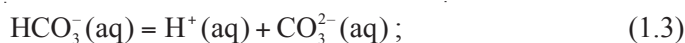
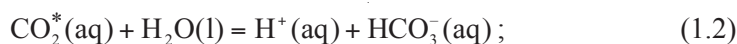

the notations (g), (l), (aq) refer to the state of the species, i.e. a gas, a liquid, or in aqueous solution respectively. Equation (1.1) refers to the solubility equilibrium of carbon dioxide between air and seawater; equations (1.2) and (1.3) are consecutive acid dissociation reactions of dissolved carbon dioxide. Two other important acid-base equilibria in seawater are the dissociation of boric acid and the self-ionisation of water:

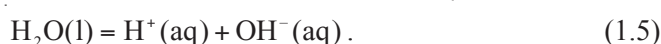
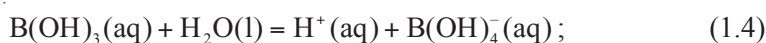

The equilibrium relationships between the concentrations of these various species can then be written in terms of the equilibrium constants:

$$K_0 = [\text{CO}_2^*] / f(\text{CO}_2); \quad (1.6)$$

$$K_1 = [\text{H}^+][\text{HCO}_3^-] / [\text{CO}_2^*]; \quad (1.7)$$

$$K_2 = [\text{H}^+][\text{CO}_3^{2-}] / [\text{HCO}_3^-]; \quad (1.8)$$

$$K_b = [\text{H}^+][\text{B}(\text{OH})_4^-] / [\text{B}(\text{OH})_3]; \quad (1.9)$$

$$K_w = [\text{H}^+][\text{OH}^-]. \quad (1.10)$$

In these equations,  $f(\text{CO}_2)$  is the fugacity of carbon dioxide in the gas phase (see Standard Operating Procedure (SOP) 24 in Dickson *et al.*, 2007) and brackets represent total stoichiometric concentrations<sup>2</sup> of the particular chemical species enclosed between them, expressed as moles per kilogram of solution. The use of fugacity in equation (1.6) allows the same equilibrium constant to be used for a wide variety of gas phase compositions (Weiss, 1974). In practice, most applications in ocean acidification studies will involve air containing carbon dioxide that is in equilibrium with the seawater at a total pressure of about 1 atmosphere. This air will thus also contain water vapour that is at its equilibrium concentration (its vapour pressure, approximately). Weiss & Price (1980) defined an alternate relationship,  $F$  such that

$$F = [\text{CO}_2^*] / x'(\text{CO}_2); \quad (1.11)$$

where  $x'(\text{CO}_2)$  is the mole fraction of  $\text{CO}_2$  present in dry air (i.e. after drying to remove the water vapour), and the appropriate corrections for non-ideality have been included implicitly. There are many situations where it is more practical to use this equation directly rather than calculating the correct  $f(\text{CO}_2)$  value.

These equilibrium constants<sup>3</sup> are functions of the temperature, pressure and salinity of the seawater and have been measured at one atmosphere pressure in a variety of studies (see Millero, 2007). Recommended values are given in Table 1.1 as a function of salinity and temperature.

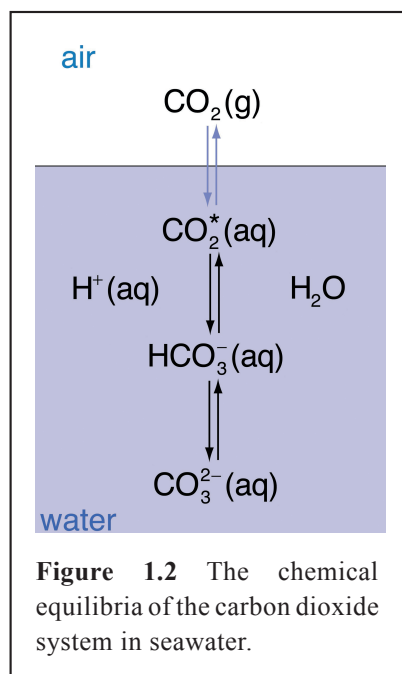

<sup>2</sup> The *total* stoichiometric concentration of a species is the sum of the concentrations of the *free* species itself, together with the concentrations of all complexes that are formed between that species and the components of the ionic medium (for seawater:  $\text{H}_2\text{O}$ ,  $\text{Na}^+$ ,  $\text{Mg}^{2+}$ ,  $\text{K}^+$ ,  $\text{Ca}^{2+}$ ,  $\text{Cl}^-$ , &  $\text{SO}_4^{2-}$ ).

<sup>3</sup> Strictly, equilibrium expressions such as equations (1.6) to (1.10) should be expressed in terms of activities rather than total stoichiometric concentrations so as to be *equilibrium constants*. However, as activity coefficients remain approximately constant for small amounts of reacting species in a background ionic medium, these expressions are valid and correspond to *ionic medium* equilibrium constants where the corresponding standard states are based on a seawater medium of a specified composition (Dickson *et al.*, 1981). Note that the activity of water is assumed to be unity.

**Table 1.1** Expressions for calculating equilibrium constants (on the total hydrogen ion scale) as a function of salinity ( $S$ ) and temperature ( $T$ , in Kelvin) (Weiss & Price, 1980; Millero, 1995; Dickson *et al.*, 2007).

Note:  $I / m^\circ = \frac{19.924S}{1000 - 1.005S} \approx 0.02S$ ;  $k^\circ = 1 \text{ mol kg}^{-1}$ .

Equilibrium constant expression	Equation in text
$\ln(K_o / k^\circ) = 93.4517 \left( \frac{100}{T} \right) - 60.2409 + 23.3585 \ln \left( \frac{T}{100} \right) + S \left( 0.023517 - 0.023656 \left( \frac{T}{100} \right) + 0.0047036 \left( \frac{T}{100} \right)^2 \right)$	(1.6)
$\log(K_1 / k^\circ) = \frac{-3633.86}{T} + 61.2172 - 9.67770 \ln(T) + 0.011555S - 0.0001152S^2$	(1.7)
$\log(K_2 / k^\circ) = \frac{-471.78}{T} - 25.9290 + 3.16967 \ln(T) + 0.01781S - 0.0001122S^2$	(1.8)
$\ln \left( \frac{K_B}{k^\circ} \right) = \frac{-8966.90 - 2890.53S^{1/2} - 77.942S + 1.728S^{3/2} - 0.0996S^2}{T} + (148.0248 + 137.1942S^{1/2} + 1.62142S) + (-24.4344 - 25.085S^{1/2} - 0.2474S) \ln(T) + 0.053105S^{1/2}T$	(1.9)
$\ln(K_w / (k^\circ)^2) = \frac{-13847.26}{T} + 148.9652 - 23.6521 \ln(T) + \left( \frac{118.67}{T} - 5.977 + 1.0495 \ln(T) \right) S^{1/2} - 0.01615S$ ;	(1.10)
$\ln \left( \frac{F}{\text{atm } k^\circ} \right) = 218.2968 \left( \frac{100}{T} \right) - 162.8301 + 90.9241 \ln \left( \frac{T}{100} \right) - 1.47696 \left( \frac{T}{100} \right)^2 + S \left( 0.025695 - 0.025225 \left( \frac{T}{100} \right) + 0.0049867 \left( \frac{T}{100} \right)^2 \right)$	(1.11)
$K_{sp}(\text{aragonite}) = -171.945 - 0.077993 T + 2903.293(T) + 71.595 \log_{10}(T) + (-0.068393 + 0.0017276 T + 88.135 T) S^{0.5} - 0.10018S + 0.0059415S^{1.5}$	(1.14)
$K_{sp}(\text{calcite}) = -171.9065 - 0.077993 T + 2839.319 T + 71.595 \log_{10} T + (-0.77712 + 0.0028426 T + 178.34 T) S^{0.5} - 0.07711S + 0.0041249S^{1.5}$	(1.15)
$\ln(K'_S / k^\circ) = \frac{-4276.1}{T} + 141.328 - 23.093 \ln(T) + \left( \frac{-13856}{T} + 324.57 - 47.986 \ln(T) \right) \times \left( \frac{I}{m^\circ} \right)^{1/2} + \left( \frac{35474}{T} - 771.54 + 114.723 \ln(T) \right) \times \left( \frac{I}{m^\circ} \right) - \frac{2698}{T} \left( \frac{I}{m^\circ} \right)^{3/2} + \frac{1776}{T} \left( \frac{I}{m^\circ} \right)^2 + \ln(1 - 0.001005S)$ ;	(1.30)
$\ln(K_f / k^\circ) = \frac{874}{T} - 9.68 + 0.111S^{1/2}$	(see 1.41)
$\ln(K_{si} / k^\circ) = \frac{-8904.2}{T} + 117.385 - 19.334 \ln(T) + \left( \frac{-458.79}{T} + 3.5913 \right) (I / m^\circ)^{1/2} + \left( \frac{188.74}{T} - 1.5998 \right) (I / m^\circ) + \left( \frac{-12.1652}{T} + 0.07871 \right) (I / m^\circ)^2 + \ln(1 - 0.001005S)$ ;	(1.45)
$\ln(K_{ip} / k^\circ) = \frac{-4576.752}{T} + 115.525 - 18.453 \ln(T) + \left( \frac{-106.736}{T} + 0.69171 \right) S^{1/2} + \left( \frac{-0.65643}{T} - 0.01844 \right) S$ ;	(1.46)
$\ln(K_{2p} / k^\circ) = \frac{-8814.715}{T} + 172.0883 - 27.927 \ln(T) + \left( \frac{-160.340}{T} + 1.3566 \right) S^{1/2} + \left( \frac{0.37335}{T} - 0.05778 \right) S$ ;	(1.47)
$\ln(K_{3p} / k^\circ) = \frac{-3070.75}{T} - 18.141 + \left( \frac{17.27039}{T} + 2.81197 \right) S^{1/2} + \left( \frac{-44.99486}{T} + 0.09984 \right) S$ ;	(1.48)
$\ln K_{NH3} = -6285.33 / T + 0.0001635T - 0.25444 + (0.46532 - 123.7184 / T) S^{0.5} + (-0.01992 + 3.17556 / T) S$	(1.49)



### 1.2.3 The saturation state of calcium carbonate minerals in seawater

There are three primary biogenic carbonate-containing mineral phases that occur in seawater: aragonite, calcite, and magnesian calcite. Aragonite and calcite are naturally occurring polymorphs of calcium carbonate with differing crystal lattice structures and hence solubilities, aragonite being about 1.5 times more soluble than calcite at 25°C. Magnesian calcite is a variety of calcite with magnesium ions randomly substituted for the calcium ions in a disordered calcite lattice. At low mole fractions of magnesium (<4%) the solubility of this phase is lower than that of calcite, whereas at high mole fractions (>12%) the solubility is greater than that of aragonite (see Figure 1.3).

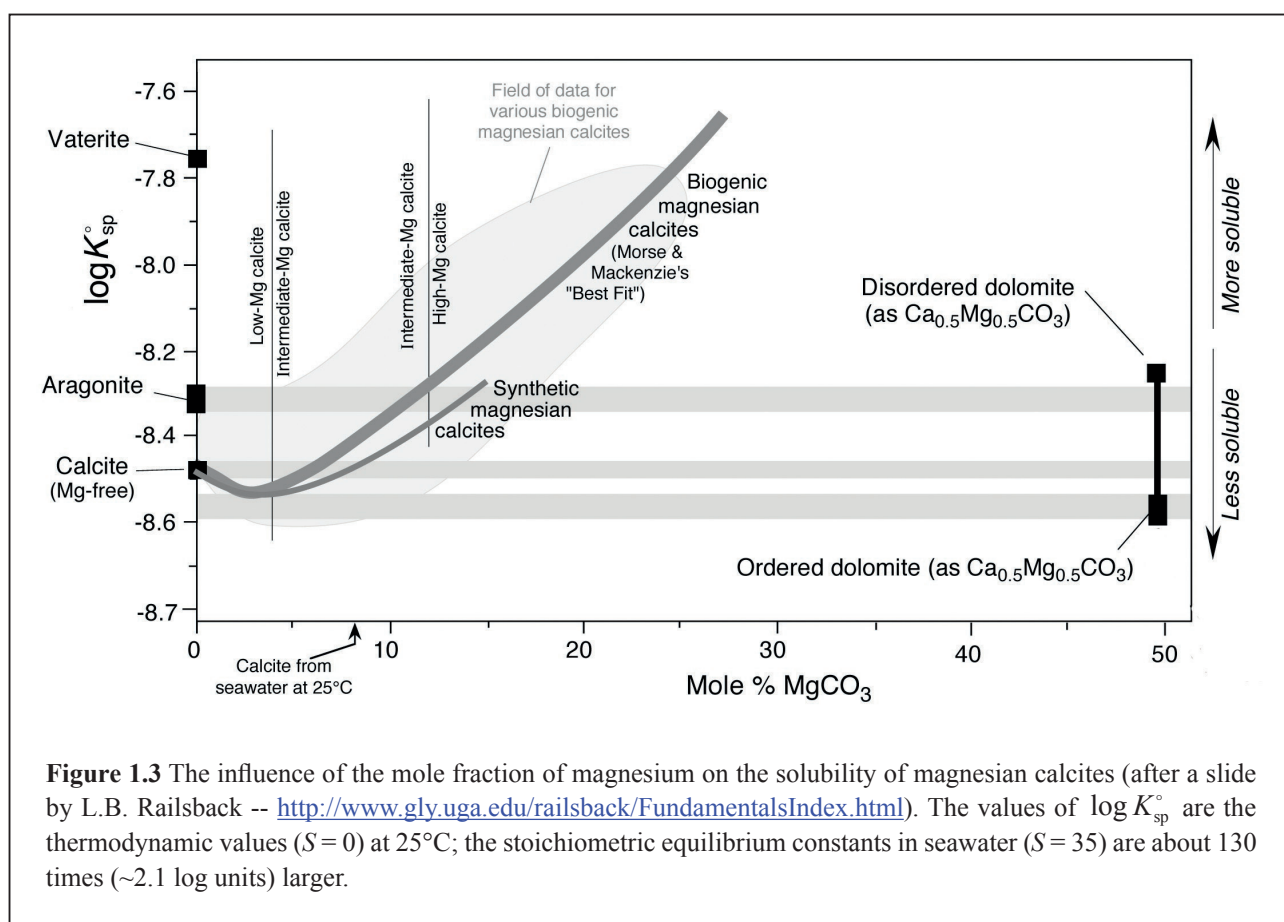

The dissolution equilibria for calcite and aragonite can be written as



where (s) indicates the solid phase. The corresponding equilibrium constant is the solubility product

$$K_{sp} = [\text{Ca}^{2+}][\text{CO}_3^{2-}]; \quad (1.13)$$

where the effect of the different crystal structure of the particular solid phase is now implicit in the solubility product itself. Strictly, aragonite and calcite have different standard Gibbs free energies, thus even when ionic medium standard states are used; the solubility products for the two minerals will have different values. It is necessary to indicate the mineral of interest explicitly, e.g.

$$K_{sp}(\text{aragonite}) = [\text{Ca}^{2+}][\text{CO}_3^{2-}]; \quad (1.14)$$

$$K_{sp}(\text{calcite}) = [\text{Ca}^{2+}][\text{CO}_3^{2-}]. \quad (1.15)$$

Clearly these equations cannot both hold true simultaneously. Aragonite is often referred to as a metastable form of calcium carbonate as it is not the form that would be expected at complete thermodynamic equilibrium.

## Part 1: Seawater carbonate chemistry

Nevertheless it is often convenient to treat the solubility of aragonite in seawater as though it were a stable phase and to apply equation (1.14) to investigate its saturation state – equation (1.17) below.

Magnesian calcites can be problematic. Their solubility is not unique, nor do they necessarily form or dissolve congruently (i.e., maintaining the same molar ratio throughout the formation or dissolution process). As a result, they do not have unique solubility products (see Figure 1.3). Nevertheless, it is sometimes useful to define *apparent* solubility products for these minerals in seawater (i.e., with essentially fixed proportions of magnesium and calcium ions) as

$$K'_{sp}(\text{mag. calcite}) = [\text{Ca}^{2+}][\text{CO}_3^{2-}]; \quad (1.16)$$

the exact value of  $K'_{sp}(\text{mag. calcite})$  at any particular salinity and temperature will then depend on the mole fraction of magnesium in the solid (see e.g. Busenberg & Plummer, 1989).

The most common use of such solubility products – particularly in ocean acidification research – is to calculate the saturation state of seawater with respect to a particular calcium carbonate mineral X. The saturation state,  $\Omega(X)$ , is defined by the expression:

$$\Omega(X) = [\text{Ca}^{2+}][\text{CO}_3^{2-}] / K_{sp}(X). \quad (1.17)$$

This expresses the ratio between the observed ion product,  $[\text{Ca}^{2+}][\text{CO}_3^{2-}]$ , and its expected value were the solution to be in equilibrium with the particular calcium carbonate mineral. If  $\Omega(X) = 1$ , the solution is in equilibrium with that mineral phase, if  $\Omega(X) > 1$  the solution is supersaturated with respect to that particular mineral phase, and if  $\Omega(X) < 1$  it is undersaturated. Insofar as the kinetics of dissolution (and formation) of such minerals have been shown to be functions of saturation state (see e.g. Morse & Arvidson, 2002; Morse *et al.*, 2007) this is a useful parameter for studies of calcification and dissolution.

### 1.2.4 Analytical parameters for the carbon dioxide system in seawater

It is usually not practical to measure the individual concentrations of each of these acid-base species in seawater directly so as to get a complete description of the composition of a particular seawater sample. Typically, the concentrations are inferred from a combination of analytical measurements made on the particular sample, together with published values for the various equilibrium constants (Table 1.1) as well as published information about the boron to salinity ratio of seawater (Table 1.2).

**Table 1.2** Reference composition of seawater (Millero *et al.*, 2008) at a practical salinity of 35.\*The DIC is 0.0019663 mol kg<sup>-1</sup>; the total concentration of boron is 0.0004151 mol kg<sup>-1</sup>. To calculate the composition at another salinity,  $[Y]_S = [Y]_{35} \times (S/35)$ , where Y refers to species that are dependent on salinity such as calcium ion concentration or total boron.

Constituent	Concentration mol kg <sup>-1</sup>
Sodium	0.4689674
Magnesium	0.0528171
Calcium	0.0102821
Potassium	0.0102077
Strontium	0.0000907
Chloride	0.5458696
Sulphate	0.0282352
Bicarbonate	0.0017177

Constituent	Concentration mol kg <sup>-1</sup>
Bromide	0.0008421
Carbonate	0.0002390
Borate	0.0001008
Fluoride	0.0000683
Hydroxide	0.0000080
Boric acid	0.0003143
Dissolved carbon dioxide	0.0000096

\*The concentrations of the various acid-base species were estimated assuming that the pH = 8.1 (on the seawater scale), and that the  $A_T = 2300 \mu\text{mol kg}^{-1}$ . The atmospheric CO<sub>2</sub> fugacity was chosen as 33.74 Pa = 333  $\mu\text{atm}$ , i.e. appropriate for the time period the original salinity/conductivity relationship was characterised (see Millero *et al.*, 2008 – p. 59).

**Salinity and temperature:** It is always important to measure salinity and temperature. The various equilibrium constants are all functions of salinity and temperature (see Table 1.1), and the composition of the solution that is inferred from the various other analytical measurements will depend on these values.

**Total dissolved inorganic carbon:** The total dissolved inorganic carbon of a seawater sample:

$$\text{DIC} = [\text{CO}_2^*] + [\text{HCO}_3^-] + [\text{CO}_3^{2-}]; \quad (1.18)$$

can be measured directly by acidifying the sample, extracting the resulting unionised carbon dioxide, and measuring its amount. The result is expressed in moles per kilogram of solution, and is independent of the temperature (and pressure) of the sample.

**Total alkalinity:** The total alkalinity of a sample of seawater is a type of mass-conservation expression for hydrogen ion relative to a chosen zero value. For simple, open-ocean surface seawater it can be approximated by the expression:

$$A_T \approx [\text{HCO}_3^-] + 2[\text{CO}_3^{2-}] + [\text{B}(\text{OH})_4^-] + [\text{OH}^-] - [\text{H}^+]. \quad (1.19)$$

The total alkalinity of a seawater sample is estimated using some form of acidimetric titration. Again, the result is expressed in moles per kilogram of solution and is independent of the temperature (and pressure) of the sample. Thus although the concentration of each of the individual species making up alkalinity changes when the temperature or pressure changes, the particular linear combination of these concentrations given in equation (1.19) remains constant.

**Hydrogen ion concentration:** The hydrogen ion concentration in seawater is reported as a pH:

$$\text{pH} = -\lg[\text{H}^+]. \quad (1.20)$$

where  $\lg x = \log_{10} x$  (Thompson & Taylor, 2008)<sup>4</sup>. Here hydrogen ion concentration is also expressed on a total scale (footnote 2) in moles per kilogram of solution. The pH of a seawater sample can be measured by one of two techniques: a potentiometric technique using an electrode that is sensitive to hydrogen ion together with a suitable reference electrode, and a spectrophotometric technique in which an indicator dye – a dye for which the acid and base forms have different colours – is added to the solution and the pH inferred from the resulting absorbance spectrum. Note that the pH of a particular sample of seawater depends upon its temperature (and pressure). If either of these is changed, the pH will change.

**$p(\text{CO}_2)$ :** The partial pressure of carbon dioxide in air in equilibrium with a seawater sample (at a specified temperature) is a measure of the degree of saturation of the sample with  $\text{CO}_2$  gas. The  $p(\text{CO}_2)$  of a particular seawater sample is a strong function of temperature, changing about 4.2% per Kelvin.

The partial pressure of a gas in a mixture is given by the expression:

$$p(\text{CO}_2) = x(\text{CO}_2)p, \quad (1.21)$$

where  $x(\text{CO}_2)$  is the mole fraction of the  $\text{CO}_2$  in the gas phase (air), and  $p$  is the total pressure. If these are known – usually from direct measurements on the gas phase – it is possible to estimate the corresponding fugacity of  $\text{CO}_2$  (see SOP 24 in Dickson *et al.*, 2007). This can then be used with the solubility constant,  $K_0$ , in equation (1.6) to calculate the concentration of dissolved, unionised carbon dioxide,  $[\text{CO}_2^*]$ . The units for fugacity are the same as for pressure, and must correspond to those used to define  $K_0$ .

Commonly it is not the  $p(\text{CO}_2)$  that is measured directly, but rather the mole fraction of  $\text{CO}_2$  in air that was in equilibrium with a water sample and which was subsequently dried before measurement. In that case, the function  $F$  presented in equation (1.11) often provides a more convenient way to calculate  $[\text{CO}_2^*]$  provided that the total pressure is approximately 1 atm. In the inverse case, where seawater is equilibrated with dry air containing a known mole fraction of  $\text{CO}_2$  at a total pressure of 1 atm, the same expression may prove useful.

<sup>4</sup> Strictly  $\text{pH} = -\log_{10} \{[\text{H}^+]/(\text{mol kg}^{-1})\}$  so as to allow the taking of the logarithm. This nicety will not be adhered to in this chapter.

There are a variety of approaches to measuring each of these parameters. At this time, the oceanographic community studying the carbon cycle in the open ocean environment has made available a *Guide to Best Practices for Ocean CO<sub>2</sub> Measurements* (Dickson *et al.*, 2007) that describes the present state-of-the-art techniques for each of these CO<sub>2</sub> parameters.

## 1.2.5 Calculation of carbon species concentrations in seawater

It is conventional to provide thermodynamic information about acid-base reactions that are written as acid dissociations – e.g. equations (1.2) to (1.5); however, these are not the only possible ways to write the various reactions. Although it is possible to write many balanced chemical reactions relating the seven individual acid-base species mentioned above (CO<sub>2</sub><sup>\*</sup>, HCO<sub>3</sub><sup>-</sup>, CO<sub>3</sub><sup>2-</sup>, B(OH)<sub>3</sub>, B(OH)<sub>4</sub><sup>-</sup>, H<sup>+</sup> and OH<sup>-</sup>), the equilibrium constant for every one of these possible reactions can be calculated from a knowledge of the four simple acid dissociation constants, (1.7) to (1.10). For example, a particularly convenient formulation that encapsulates the equilibrium relationship between the concentrations of the various carbon dioxide species is

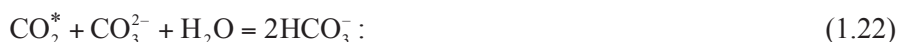

notations in parentheses indicating the state of the various species (g, l, aq, s) are omitted from now on to simplify the various expressions.

An examination of this equation tells us essentially what happens as the dissolved carbon dioxide concentration increases (for example by dissolution of CO<sub>2</sub> from the atmosphere). The additional carbon dioxide reacts with carbonate ion to form bicarbonate ion. The net effect is to increase the concentrations of dissolved carbon dioxide and bicarbonate ion, while decreasing the concentration of carbonate ion. The extent to which this occurs (at any particular salinity and temperature) can be inferred from the equilibrium constant corresponding to reaction (1.22), which in turn can be derived from equations (1.7) and (1.8):

$$K = K_1 / K_2 = [\text{HCO}_3^-]^2 / ([\text{CO}_2^*][\text{CO}_3^{2-}]) \quad (1.23)$$

In Figure 1.4a, I have used equation (1.23) to construct a contour plot indicating how the concentrations of bicarbonate ion ([HCO<sub>3</sub><sup>-</sup>]) in seawater media can be viewed as a function of the concentration of dissolved carbon dioxide ([CO<sub>2</sub><sup>\*</sup>]) and of carbonate ion ([CO<sub>3</sub><sup>2-</sup>]) at *S* = 35 and *t* = 25°C (*T* = 298.15 K). The *x*-axis is also marked in terms of *f*(CO<sub>2</sub>), which is directly proportional to [CO<sub>2</sub><sup>\*</sup>]— equation (1.6).

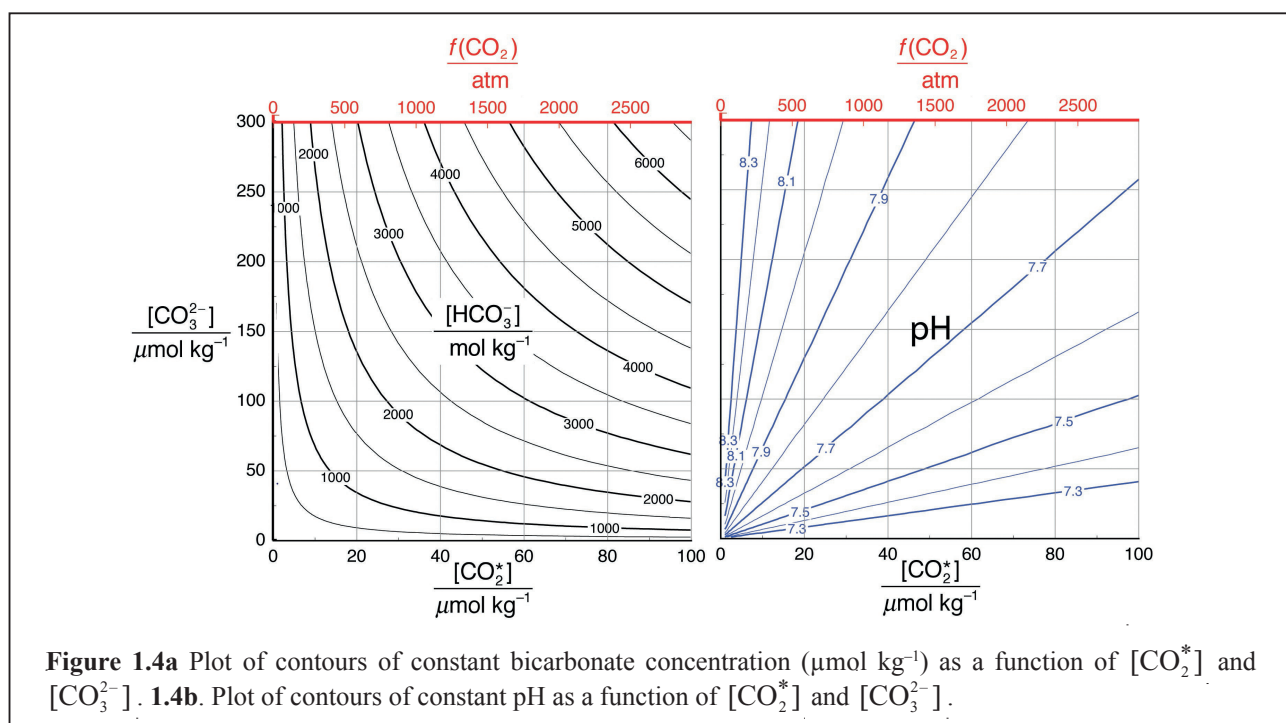

**Figure 1.4a** Plot of contours of constant bicarbonate concentration (μmol kg<sup>-1</sup>) as a function of [CO<sub>2</sub><sup>\*</sup>] and [CO<sub>3</sub><sup>2-</sup>]. **1.4b.** Plot of contours of constant pH as a function of [CO<sub>2</sub><sup>\*</sup>] and [CO<sub>3</sub><sup>2-</sup>].

Another convenient reaction relates carbonate ion directly to the dissolved carbon dioxide:



The equilibrium constant for this reaction is then the product of  $K_1$  and  $K_2$ :

$$K_1K_2 = [\text{H}^+]^2[\text{CO}_3^{2-}]/[\text{CO}_2^*] \quad (1.25)$$

Examination of this expression shows that the concentration ratio  $[\text{CO}_3^{2-}]/[\text{CO}_2^*]$  is a function of the hydrogen ion concentration and thus of the pH – equation (1.20). This is shown in Figure 1.4b.

If one picks a particular point on these graphs, i.e. specifying  $[\text{CO}_2^*]$  and  $[\text{CO}_3^{2-}]$ , all the other information about the concentrations of the other acid-base species is necessarily defined in terms of the various equilibrium constants (which in turn depend on the salinity and temperature). For example,  $[\text{HCO}_3^-]$  can be calculated from equation (1.23) and  $[\text{H}^+]$  from equation (1.25). Then once  $[\text{H}^+]$  is known,  $[\text{OH}^-]$  can be calculated from equation (1.10) and the ratio  $[\text{B}(\text{OH})_4^-]/[\text{B}(\text{OH})_3]$  from equation (1.9). We also know the total boron concentration in the seawater:  $[\text{B}(\text{OH})_4^-] + [\text{B}(\text{OH})_3]$ , which varies in direct proportion to the salinity (Table 1.2), so the individual concentrations of  $[\text{B}(\text{OH})_4^-]$  and  $[\text{B}(\text{OH})_3]$  can be estimated. Note too that each of the analytical parameters mentioned above: DIC,  $A_T$ , pH and  $p(\text{CO}_2)$ , can in turn be estimated once these various concentrations are known.

In general therefore, the composition of the carbon dioxide system in any seawater sample is specified completely once one knows the salinity and temperature (and hence the values for all the various equilibrium constants), together with two other concentration-related parameters (in addition to the total boron/salinity ratio). These other concentration-related parameters are typically chosen from those mentioned above: DIC,  $A_T$ , pH and  $p(\text{CO}_2)$ . The advantages and disadvantages of choosing a particular pair are discussed later in this chapter.

If one also wishes to estimate the saturation state – equation (1.17) – with regard to a particular calcium carbonate mineral, in addition to the appropriate solubility product, one also needs the concentration of calcium ion. For unmodified seawaters this too can be estimated from the salinity (Table 1.2).

There are a variety of programs available to do these calculations. Perhaps the most widely known is CO2SYS which was originally made available as a DOS executable (Lewis & Wallace, 1998), but which is now also available as Excel macros or as MATLAB code at <http://cdiac.ornl.gov/oceans/co2rprt.html>. Other similar programs are available, for example csys, a series of MATLAB files based on the book by Zeebe & Wolf-Gladrow (2001), is available at [http://www.soest.hawaii.edu/oceanography/faculty/zeebe\\_files/CO2\\_System\\_in\\_Seawater/csys.html](http://www.soest.hawaii.edu/oceanography/faculty/zeebe_files/CO2_System_in_Seawater/csys.html); seacarb, a series of functions written in R (Lavigne & Gattuso, 2010), is available at <http://cran.at.r-project.org/web/packages/seacarb/index.html>; and SWCO2, a package available from Keith Hunter at [http://neon.otago.ac.nz/research/mfc/people/keith\\_hunter/software/swco2/](http://neon.otago.ac.nz/research/mfc/people/keith_hunter/software/swco2/).

When doing such calculations, with or without a standard package, there are two important considerations. First, it is desirable to use the best available values for the equilibrium constants. However, it may not always be clear from a particular program, just which constants have been selected for use. The expressions given in Table 1.1 are those recommended in the recently published *Guide to best practices for ocean CO<sub>2</sub> measurements* (Dickson *et al.*, 2007) and are on the *total* hydrogen ion concentration scale. Second, if pH measurements are made, it is essential that the pH be defined in the same way it was for the equilibrium constants. This is discussed in more detail below.

### 1.3 The definition and measurement of pH in seawater

#### 1.3.1 Introduction

Unfortunately, as noted by Dickson (1984), the field of pH scales and the study of acid-base reactions in seawater is one of the more confused areas of marine chemistry. The primary intent of measuring pH is to use it together with appropriated acid-dissociation constants (and other information – see section 1.2.5 above) to calculate the speciation of the various acid-base systems in seawater. For a particular acid-dissociation, e.g.



the corresponding equilibrium expression can be written in the form

$$\text{pH} + \lg K(\text{HB}) = \lg\{[\text{B}^-]/[\text{HB}]\}. \quad (1.27)$$

If the pH scale is changed, changing the numerical value of pH, the corresponding value of the equilibrium constant must also change, and by the same amount, to ensure that the right hand side of this equation remains constant. It is thus essential that the pH is defined on the same pH scale as that of all acid-dissociation constants that are used with it.

The pH of seawater is best defined in terms of the concentration of hydrogen ion on the total hydrogen ion concentration scale (strictly the activity of hydrogen ion referenced to an *ionic medium* standard state, see footnote 3), and that is the approach recommended here. The equilibrium constants recommended in Dickson *et al.* (2007) and provided in this chapter (Table 1.1) are also defined using this pH scale.

### 1.3.2 The total hydrogen ion concentration scale

A key feature underlying the study of acid-base chemistry in seawater is the (often implicit) use of ionic medium standard states making it practical to define equilibrium constants that are based on concentration products, e.g., equations (1.7) to (1.10). The pH is defined as

$$\text{pH} = -\lg[\text{H}^+]; \quad (1.28)$$

where the square brackets again imply *total* concentration, that is the sum of the concentration of the *free* species itself, together with the concentrations of all complexes that are formed between that species and the components of the ionic medium (for seawater:  $\text{H}_2\text{O}$ ,  $\text{Na}^+$ ,  $\text{Mg}^{2+}$ ,  $\text{K}^+$ ,  $\text{Ca}^{2+}$ ,  $\text{Cl}^-$ , and  $\text{SO}_4^{2-}$ ).

In the case of hydrogen ion, such complexes occur with water (there are no unhydrated protons present in aqueous solution), and with sulphate ion to form the hydrogen sulphate anion:  $\text{HSO}_4^-$ . This interaction is usually written as the dissociation:

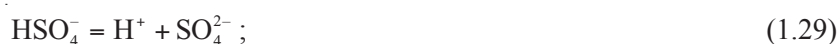

with the associated equilibrium constant,

$$K'_S = [\text{H}^+]_F [\text{SO}_4^{2-}] / [\text{HSO}_4^-]. \quad (1.30)$$

The term  $[\text{H}^+]_F$  indicates that here the hydrogen ion concentration is the *free* concentration (i.e., including only the hydrated forms of the ion), and the prime indicates that the equilibrium constant is defined accordingly. Thus one might expect the total hydrogen ion concentration to be expressed as:

$$[\text{H}^+] = [\text{H}^+]_F + [\text{HSO}_4^-]. \quad (1.31)$$

Substituting equation (1.30) in this, gives

$$[\text{H}^+] = [\text{H}^+]_F (1 + [\text{SO}_4^{2-}] / K'_S). \quad (1.32)$$

The term in parentheses is essentially constant at  $\text{pH} > 5$ . To ensure that  $[\text{H}^+] \propto [\text{H}^+]_F$  even at lower pH's such as are found in an alkalinity titration or other solutions that have high acid levels, Dickson (1990) proposed that the *total* hydrogen ion scale for seawater be defined as

$$[\text{H}^+] = [\text{H}^+]_F (1 + S_T / K'_S); \quad (1.33)$$

where  $S_T$  is the total amount of sulphate ion present in the seawater and this is the current definition. At  $\text{pH} > 5$ , equations (1.32) and (1.33) are essentially equivalent.

### 1.3.3 Measuring total hydrogen ion concentration using a pH cell

The standard potentiometric technique (Dickson, 1993; Dickson *et al.*, 2007) uses the pH cell:

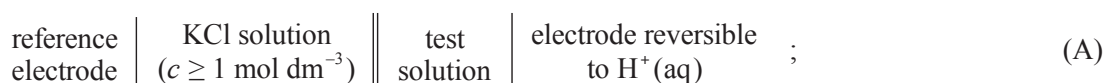

where typically the electrode reversible to hydrogen ion is a glass electrode, often in a combination format with the associated reference electrode. The pH of a sample is then defined in terms of electromotive force measurements on the sample itself (X) and on a standard buffer solution (S) of assigned pH:

$$\text{pH}(X) = \text{pH}(S) - \frac{E_x - E_s}{RT \ln 10 / F} \quad (1.34)$$

In this equation pH(X) and pH(S) are the pHs of the sample and standard buffer, respectively;  $E_x$  and  $E_s$  are the corresponding e.m.f.s obtained with cell (A) on these solutions;  $T$  is the measurement temperature (note that both sample solution and standard buffer *must* be at the same temperature); and  $R$  and  $F$  are the gas and Faraday constants, respectively. The primary standard buffer for the measurement of total hydrogen ion concentrations in seawater media is based on 2-amino-2-methyl-1,3-propanediol (Tris) in synthetic seawater, and its pH values are assigned using Harned cells – cells with hydrogen and silver/silver chloride electrodes (DelValls & Dickson, 1998; Nemzer & Dickson, 2005).

Although it is practical to make up one's own Tris buffers in accordance with the recipe given by Nemzer & Dickson (2005), it is not particularly straightforward and requires some care to ensure values that are in good agreement (0.005) with those published by DelValls & Dickson (1998). It is recommended that such “home-made” buffers be calibrated against a primary standard buffer wherever practical.

A further complication with using such buffers is that, ideally, the salinity of the buffer matches the salinity of the sample being tested. This is rarely the case, however it has been shown that if the salinity is relatively close (within 5) of the buffer (usually prepared with a nominal salinity of 35), then the likely error is less than 0.01 in pH (Whitfield *et al.*, 1985).

If this electrode-based technique is used to measure pH, the overall uncertainty for the pH measurement is probably less than 0.02 for seawater measurements in the pH range 7.5-8.5, provided that the electrode slope is Nernstian or nearly so (>99%). If the quality of the electrode has not been assessed independently this uncertainty can be larger, but as the pH(S) of Tris buffer is about 8.1, the errors will not be very large within the usual seawater pH range (7.5-8.5).

### 1.3.4 Measuring total hydrogen ion concentration using an indicator dye

The spectrophotometric approach to pH measurement involves adding a small amount of a solution of a pH indicator dye to the seawater sample (e.g. Clayton & Byrne, 1993; Dickson *et al.*, 2007). The dye is an acid-base compound such as *m*-cresol purple whose second dissociation:



occurs at around seawater pH thus ensuring that both species are present in measurable amounts. The expression for the acid-dissociation constant for this dye

$$K(\text{HI}^-) = [\text{H}^+][\text{I}^{2-}]/[\text{HI}^-]; \quad (1.36)$$

can be rewritten as

$$\text{pH} = -\lg K(\text{HI}^-) + \lg \{[\text{I}^{2-}]/[\text{HI}^-]\} \quad (1.37)$$

The spectrophotometric approach uses the fact that the acid and base forms of the indicator have substantially different absorbance spectra. Thus the information contained in the spectrum for the indicator dye in the seawater solution is sufficient to estimate the second term on the right hand side of equation (1.37). The total absorbance at a particular wavelength  $\lambda$ ,

$$A_\lambda = \varepsilon_\lambda(\text{HI}^-)[\text{HI}^-] + \varepsilon_\lambda(\text{I}^{2-})[\text{I}^{2-}]; \quad (1.38)$$

where  $\varepsilon_\lambda(\text{HI}^-)$  and  $\varepsilon_\lambda(\text{I}^{2-})$  are the extinction coefficients at that wavelength of the acid and base forms of the dye, respectively.

Typically absorbance information from two wavelengths (1) and (2) suffices to compute the pH:

$$\text{pH} = -\lg K(\text{HI}^-) + \lg \left( \frac{A_1 / A_2 - \varepsilon_1(\text{HI}^-) / \varepsilon_2(\text{HI}^-)}{\varepsilon_1(\text{I}^{2-}) / \varepsilon_1(\text{HI}^-) - (A_1 / A_2) \varepsilon_2(\text{I}^{2-}) / \varepsilon_2(\text{HI}^-)} \right). \quad (1.39)$$

These two wavelengths are usually chosen to correspond to the absorbance maxima for the base (1) and acid (2) forms of the dye. This choice of wavelengths is at once the most sensitive to pH changes as well as forgiving of minor deviations in wavelength reproducibility. The properties of the indicator dye *m*-cresol purple: equilibrium constant<sup>5</sup> and extinction coefficient ratios, have been described by Clayton & Byrne (1993). This method is also calibrated by assigning the value of  $K(\text{HI}^-)$ , in solutions of known  $[\text{H}^+]$ , ideally using primary standard buffers certified using a Harned Cell.

For the most accurate measurements, it is important to allow for the pH change resulting from the dye addition (Clayton & Byrne, 1993; Dickson *et al.*, 2007). This is usually minimised by adjusting the pH of the dye stock solution to be similar to that of the samples being measured. Unfortunately, it has also been suggested recently that these dyes, when obtained commercially, may have small amounts of coloured impurities that can vary from lot to lot. This will affect the apparent extinction coefficient ratios and can contribute as much as 0.01 to the overall uncertainty of the resulting pH data (Yao *et al.*, 2007). Thus the appropriate overall uncertainty estimate for spectrophotometric pH measurements is probably about 0.01 in pH.

### 1.3.5 Other pH scales (that are not recommended for use)

Two other pH scales have been used for seawater measurements in the past:

1. The so-called NBS scale (more correctly now referred to as the IUPAC scale) was based originally on recommendations and primary buffer standards from the US National Bureau of Standards (NBS), renamed the National Institute of Standards and Technology in 1988.
2. The seawater pH scale (SWS) which includes fluoride ion in the ionic medium (in addition to sulphate) and thus includes the species HF in the definition of the SWS hydrogen ion concentration:

$$[\text{H}^+]_{\text{SWS}} = [\text{H}^+]_{\text{F}} + [\text{HSO}_4^-] + [\text{HF}]; \quad (1.40)$$

or, more strictly,

$$[\text{H}^+]_{\text{SWS}} = [\text{H}^+]_{\text{F}} (1 + S_{\text{T}} / K'_{\text{S}} + F_{\text{T}} / K'_{\text{F}}); \quad (1.41)$$

where  $F_{\text{T}}$  is the total concentration of fluoride ion in the seawater, and  $K'_{\text{F}}$  is the dissociation constant for HF with hydrogen ion concentration expressed as the *free* concentration.

The uncertainty inherent in using the IUPAC scale for seawater measurements may be as large as 0.05 in pH, even for careful measurements. For the seawater scale, the errors will be approximately the same as for the total scale, provided that measurements are made in a similar fashion. It will however be important to assure oneself that indeed the standard buffer or the indicator dye's  $\text{p}K$  have been assigned values on this scale. Note that if it is necessary to calculate the amount of hydrogen fluoride in a particular sample, it can be estimated from knowledge of the total hydrogen ion concentration, the total fluoride concentration (proportional to salinity) and the corresponding equilibrium constant.

Whatever pH scale is employed, it is essential that it be used with equilibrium constants defined on the same scale. If one were to use pH measurements on the IUPAC scale with the constants of Table 1.1 (on the total hydrogen ion scale) an additional systematic error of about 0.15 pH units would be incurred at 25°C ( $\text{pH} \approx \text{pH}(\text{NBS}) - 0.15$ ). For seawater scale pH measurements, the error is about 0.01 units ( $\text{pH} \approx \text{pH}(\text{SWS}) + 0.01$ ).

<sup>5</sup> The paper of DelValls & Dickson (1998) suggests that the buffer used by Clayton & Byrne (1993) to estimate  $K(\text{HI}^-)$  may have been assigned an inappropriate pH. This has not yet been confirmed. Recent work in my laboratory, however, suggests an additional systematic error may largely counteract the proposed original error.



## 1.4 Implications of other acid-base equilibria in seawater on seawater alkalinity

### 1.4.1 Natural seawater

In addition to the various species detailed above, i.e. those from carbon dioxide, boric acid or water, natural seawater can contain a number of other acid-base species in significant amounts. The most common are a variety of minor nutrient species that also have acid-base behaviour (e.g. silicate, phosphate, and ammonia):



The dissociation constants for these various equilibria are thus

$$K_{\text{Si}} = [\text{H}^+][\text{SiO(OH)}_3^-]/[\text{Si(OH)}_4]; \quad (1.45)$$

$$K_{1\text{P}} = [\text{H}^+][\text{H}_2\text{PO}_4^-]/[\text{H}_3\text{PO}_4]; \quad (1.46)$$

$$K_{2\text{P}} = [\text{H}^+][\text{HPO}_4^{2-}]/[\text{H}_2\text{PO}_4^-]; \quad (1.47)$$

$$K_{3\text{P}} = [\text{H}^+][\text{PO}_4^{3-}]/[\text{HPO}_4^{2-}]; \quad (1.48)$$

$$K_{\text{NH}_3} = [\text{H}^+][\text{NH}_3]/[\text{NH}_4^+]. \quad (1.49)$$

Although ammonia is typically present at very low amounts ( $< 1 \mu\text{mol kg}^{-1}$ ) in oxygenated seawater and can usually be ignored, the other species are present at significant concentrations in deep water, and can be upwelled to the surface in various regions. In addition, there is the potential for additional organic acid-base species to be present, especially in enclosed systems with significant biological activity (Hernández-Ayón *et al.*, 2007; Kim & Lee, 2009).

The net effect is to add additional species into the expression for the total alkalinity of seawater which is rigorously defined (Dickson, 1981) as “. . . the number of moles of hydrogen ion equivalent to the excess of proton acceptors (bases formed from weak acids with a dissociation constant  $K \leq 10^{-4.5}$  at 25°C and zero ionic strength) over proton donors (acids with  $K > 10^{-4.5}$ ) in 1 kilogram of sample.” Thus

$$\begin{aligned} A_T = & [\text{HCO}_3^-] + 2[\text{CO}_3^{2-}] + [\text{B(OH)}_4^-] + [\text{OH}^-] + [\text{HPO}_4^{2-}] \\ & + 2[\text{PO}_4^{3-}] + [\text{SiO(OH)}_3^-] + [\text{NH}_3] + [\text{HS}^-] + \dots \\ & - [\text{H}^+]_f - [\text{HSO}_4^-] - [\text{HF}] - [\text{H}_3\text{PO}_4] - \dots \end{aligned} \quad (1.50)$$

where the ellipses stand for additional minor acid or base species that are either unidentified or present in such small amounts that they can be safely neglected.  $[\text{H}^+]_f$  is the *free* concentration of hydrogen ion. Wolf-Gladrow *et al.* (2007) provide a detailed discussion of the origins of this expression and its application to biogeochemical processes.

For natural seawater these additional components do not usually complicate the *measurement* of total alkalinity, the value of which can be determined fairly accurately even if the existence of such species is ignored. However, it will affect significantly the *use* of this measured total alkalinity in inferring the composition of the seawater solution (section 1.2.5). One way to think about this is to consider how much each acid-base system contributes to the total alkalinity of a particular sample. Thus the “phosphate alkalinity” ( $[\text{HPO}_4^{2-}] + 2[\text{PO}_4^{3-}] - [\text{H}_3\text{PO}_4]$ ) in most samples (pH range 7–8) is approximately equal to the total concentration of phosphate in the sample, whereas for silicate the “silicate alkalinity” ( $[\text{SiO(OH)}_3^-]$ ) depends strongly on pH, and at pH 8 will be about 3% of the total silicate concentration (less at lower pH's). Ignoring such contributions from these minor acid-base systems is thus equivalent to the alkalinity value being in error by the corresponding amount.

Essentially any computation involving total alkalinity requires (as with borate) that the total concentrations and the various equilibrium constants of all these other acid base systems be known so that they can be accounted for (see Table 1.2). If they are not well known there will be an inherent uncertainty in the computed speciation.

## Part 1: Seawater carbonate chemistry

In the case of substantial organic contributions to the alkalinity such information may well not be available, and total alkalinity, though measurable, may not be fully interpretable.

### 1.4.2 Modified seawater media – implications for alkalinity

Often when culturing organisms in the laboratory, it will be common to have high concentrations of these nutrient species (and possibly of ammonia and of various organic acid-base species). If this is indeed the case, it is unlikely that measurements of total alkalinity will provide the information desired about the sample's carbon dioxide speciation without significant (and possibly a prohibitive amount of) extra work. This is particularly true if other acid-base species are deliberately added to the culture medium (for example the use of HEPES to control pH). It will then almost certainly be impossible to infer anything useful from a total alkalinity measurement and other techniques must be used.

## 1.5 Choosing the appropriate measurement techniques

### 1.5.1 Introduction

As was discussed in section 1.2.5, there are no analytical methods that measure directly the individual concentrations of all the various acid-base species that are present in seawater. These concentrations are usually inferred from measurements of salinity, temperature, and at least two of the analytical parameters introduced in section 1.2.4, in addition to the various other equilibrium constants, etc. The question for an investigator then becomes: which two parameters should I choose to measure? Furthermore, what measurement techniques should I use to estimate them?

A key aspect of making appropriate choices is that the measurements chosen be *fit for purpose*, that is, able to achieve the goals: uncertainty, convenience, speed, cost, etc., of the ocean acidification study being undertaken. An important first step is to define clearly the purpose for which the measurements are being made and to specify the associated constraints on the uncertainty required of the analytical measurements as well as other necessary considerations.

### 1.5.2 Available measurement techniques

In the 1990s a group of US investigators decided to document the techniques that they were using for open ocean studies of the carbon dioxide system in seawater. The resulting handbook (DOE, 1994) was made available through CDIAC as a printed book, as well as electronically. Recently an effort was made to update this information. This resulting document was published as the *Guide to best practices for ocean CO<sub>2</sub> measurements* (Dickson *et al.*, 2007) by PICES; it is available on the web at: [http://cdiac.ornl.gov/oceans/Handbook\\_2007.html](http://cdiac.ornl.gov/oceans/Handbook_2007.html).

This *Guide* provides detailed standard operating procedures for each of the current state-of-the-art techniques for measuring the various parameters of the seawater carbon dioxide system. Unfortunately, none of these techniques can be described as routine. Each requires trained analytical staff to perform the technique described, and much of the instrumentation described in the *Guide* is not commercially available. In fact most such instrumentation in use is, to some degree or another, “home-built” and it involves a significant cost to acquire (or build) a working instrument (including the necessary training of personnel). Furthermore, these instruments have not usually been optimised for ease of use or even ease of maintenance.

The combined standard uncertainty of these various techniques has – as yet – not been evaluated fully, but it is fair to say that on the whole the techniques detailed in the *Guide* are aimed at getting the best possible quality of measurement data for the carbon dioxide system in seawater. Furthermore, many of them have been used extensively in multiple laboratories and there is – within the user community – a reasonable understanding of their uncertainty, as well as of their advantages and disadvantages.

In addition to the techniques outlined in the *Guide*, a few other approaches (see Table 1.3) are worthy of consideration as being of appropriate quality for ocean acidification studies while being – perhaps – more cost-effective. Instrumentation for some of these techniques is now available commercially (typically from individual scientists who have established

companies to build and sell such instrumentation), but – as a result of the limited market for such instrumentation – none of them is available as a “turnkey” system, nor is there a well-developed support infrastructure providing the necessary training or instrument servicing. Furthermore, at this time such techniques have rarely been described with the level of detail outlined in the *Guide* nor have they been independently and rigorously tested.

**Table 1.3** Methods for the measurement of parameters of the carbon dioxide system in seawater (also see notes below).

<p><b>Total dissolved inorganic carbon</b></p> <p>A. Acidification / vacuum extraction / manometric determination</p> <p>B. Acidification / gas stripping / coulometric determination</p> <p>C. Acidification / gas stripping / infrared detection</p> <p>D. Closed-cell acidimetric titration</p>
<p><b>Total alkalinity</b></p> <p>E. Closed-cell acidimetric titration</p> <p>F. Open-cell acidimetric titration</p> <p>G. Other titration systems</p>
<p><b>pH</b></p> <p>H. Electrometric determination with standard Tris buffer</p> <p>I. Spectrophotometric determination using <i>m</i>-cresol purple</p>
<p><b><math>x'(\text{CO}_2)</math> / <math>p(\text{CO}_2)</math></b></p> <p>J. Direct infrared determination of <math>x'(\text{CO}_2)</math></p>

- A. This method is used in my laboratory for the certification of reference materials.
- B. This is the method described in SOP 2 of Dickson *et al.* (2007). A system for implementing this (VINDTA 3C) is available from Marianda (<http://www.marianda.com>)
- C. This approach has been described in various publications (e.g. Goyet & Snover, 1993). Systems for implementing it are available from Apollo SciTech, Inc. (<http://apolloscitech.com>), and from Marianda (AIRICA: <http://www.marianda.com>).
- D. This method is not recommended. If the electrode used is non-Nernstian, a significant error is introduced in the estimation of DIC.
- E. This method is described as SOP 3a of Dickson *et al.* (2007). A system for implementing this (VINDTA 3S) is available from Marianda (<http://www.marianda.com>).
- F. This method is used in my laboratory for the certification of reference materials (Dickson *et al.*, 2003). It is described as SOP 3b of Dickson *et al.* (2007), and also as ISO 22719:2008 “Water quality – Determination of total alkalinity in seawater using high precision potentiometric titration.”
- G. A number of titration systems are now available for this: from the Kimoto Electric Co. (<http://www.kimoto-electric.co.jp/english/product/ocean/alkali.html>), from Apollo SciTech, Inc. (<http://apolloscitech.com>), and from Langdon Enterprises ([clangdon920@yahoo.com](mailto:clangdon920@yahoo.com)). Although all are described as capable of good repeatability, their reproducibility and uncertainty are unknown.
- H. This requires a high-quality pH meter (readable to 0.1 mV, 0.001 in pH) and access to certified Tris buffers. (The method is described in SOP 6a of Dickson *et al.*, 2007).
- I. This method is described in SOP 6b of Dickson *et al.* (2007), however see Yao *et al.* (2007).
- J. This method is described in SOP 5 of Dickson *et al.* (2007), and requires a significant amount of seawater such as a flowing stream of seawater: e.g., the system marketed by General Oceanics: <http://www.generaloceanics.com/genocean/8050/8050.htm>. If however, it is desired to make the measurement on a discrete sample of seawater, the uncertainty is increased to between 0.5 and 1.0%. One such method is described in SOP 4 of Dickson *et al.* (2007); another in a paper by Neill *et al.* (1997).

In Table 1.4, I provide estimates of the measurement uncertainty for the various primary analytical parameters. These are only for guidance, the magnitudes of these uncertainties depend not only on the measurement technique employed, but also on the metrological traceability of the measured results, as well as on the implementation of the technique in a particular laboratory (skill of analysts, quality assurance program, etc.); thus the measurement uncertainty value should be estimated separately by each individual laboratory.

**Table 1.4** Estimated measurement uncertainties for the measurement of parameters of the carbon dioxide system in seawater (for a single measurement on a sample of surface seawater). RM: Reference materials.

Parameter	Reference method	State-of-the-art (using RMs) <sup>*</sup>	Other techniques (using RMs)	Without using RMs <sup>†</sup>
Total alkalinity	1.2 $\mu\text{mol kg}^{-1}$	2-3 $\mu\text{mol kg}^{-1}$	4-10 $\mu\text{mol kg}^{-1}$	?
Total dissolved inorganic carbon	1.0 $\mu\text{mol kg}^{-1}$	2-3 $\mu\text{mol kg}^{-1}$	4-10 $\mu\text{mol kg}^{-1}$	?
pH	0.003 <sup>‡</sup>	$\sim 0.005$ <sup>‡</sup>	0.01-0.03	?
$x'(\text{CO}_2) / p(\text{CO}_2)$	1.0 $\mu\text{atm}$	$\sim 2$ $\mu\text{atm}$	5-10 $\mu\text{atm}$	?

<sup>\*</sup>The methods described in Dickson *et al.* (2007), performed by an experienced laboratory with well-trained analysts, and with a good quality assurance program in place.

<sup>†</sup>If appropriate reference materials are not used, it is usually not practical to assign a measurement uncertainty.

<sup>‡</sup>These levels of uncertainty in pH require that the apparent dye extinction coefficient ratios be appropriate to the particular lot of dye being used (see discussion in Yao *et al.* (2007)).

### 1.5.3 Quality assurance of measurements

Quality assurance constitutes the system by which an analytical laboratory can assure outside users that the analytical results they produce are of proven and known quality (Dux, 1990). A formal quality assurance program will be required for the carbon dioxide measurements performed in association with ocean acidification studies. A quality assurance program consist of two separate related activities (Taylor, 1987):

**Quality control:** The overall system of activities whose purpose is to control the quality of a measurement so that it meets the needs of users. The aim is to ensure that data generated are of known accuracy to some stated, quantitative, degree of probability, and thus provides quality that is satisfactory, dependable, and economic.

**Quality assessment:** The overall system of activities whose purpose is to provide assurance that quality control is being done effectively. It provides a continuing evaluation of the quality of the analyses and of the performance of the associated analytical systems.

These are discussed in detail in the books of Taylor (1987) and of Dux (1990), and a brief description appropriate to ocean carbon dioxide measurements is given in Chapter 3 of Dickson *et al.* (2007). In particular, effective quality control requires at a minimum the following:

- Suitable and properly maintained equipment and facilities,
- Well documented measurement procedures (SOPs),
- Regular and appropriate use of reference materials to evaluate measurement performance,
- Appropriate documentation of measurements and associated quality control information.

As noted above, regular use of reference materials is the preferred approach to evaluating measurement quality. Reference materials are stable substances for which one or more properties are established sufficiently well to calibrate a chemical analyser or to validate a measurement process (Taylor, 1987). Ideally, such materials are based on a matrix similar to that of the samples of interest, in this case seawater. The most useful reference

materials are those for which one or more of the properties have been *certified* as accurate, preferably by the use of a definitive method in the hands of two or more analysts.

The US National Science Foundation has, since 1988, supported my laboratory at the Scripps Institution of Oceanography to produce and distribute such reference materials for the quality control of ocean CO<sub>2</sub> measurements (see Table 1.5). They should be used regularly to ensure the quality of measurements performed in support of ocean acidification studies.

**Table 1.5** Availability of reference materials for the quality control of carbon dioxide measurements in seawater. RM: Reference materials.

Analytical measurement	Desired accuracy <sup>†</sup>	Uncertainty <sup>††</sup>	Availability
Total dissolved inorganic carbon	± 1 µmol kg <sup>-1</sup>	± 1 µmol kg <sup>-1</sup>	Since 1991 <sup>(a)</sup>
Total alkalinity	± 1 µmol kg <sup>-1</sup>	± 1 µmol kg <sup>-1</sup>	Since 1996 <sup>(b)</sup>
pH	± 0.002	± 0.003	Since 2009 <sup>(c)</sup>
Mole fraction of CO <sub>2</sub> in dry air	± 0.5 µmol/mol	± 0.1 µmol/mol	Since 1995 <sup>(d)</sup>

<sup>†</sup>These values are based on considerations outlined in the report of SCOR Working Group 75 (SCOR, 1985). They reflect the desire to measure changes in the CO<sub>2</sub> content of seawater that allow the increases due to the burning of fossil fuels to be observed.

<sup>††</sup>Estimated standard uncertainties for the reference materials described here.

<sup>(a)</sup>Sterilised natural seawater, certified using a definitive method based on acidification, vacuum extraction, and manometric determination of the CO<sub>2</sub> released. Available from UC San Diego (<http://andrew.ucsd.edu/co2qc/>).

<sup>(b)</sup>Certified using a definitive method based on an open-cell acidimetric titration technique (Dickson *et al.*, 2003). Available from UC San Diego (<http://andrew.ucsd.edu/co2qc/>).

<sup>(c)</sup>Standard buffer solutions based on Tris in synthetic seawater (Nemzer & Dickson, 2005). Available from UC San Diego (<http://andrew.ucsd.edu/co2qc/>).

<sup>(d)</sup>Cylinders of air certified by non-dispersive infrared spectrometry. Available from NOAA/ESRL, Boulder, CO (<http://www.esrl.noaa.gov/gmd/ccgg/refgases/stdgases.html>). However, gas mixtures certified to a lesser accuracy can be obtained from a variety of manufacturers.

#### 1.5.4 Error propagation and its implications

Although, mathematically (in a system without any uncertainties) the use of different combinations of analytical parameters should provide equivalent information, in practice that is not the case. The inherent measurement uncertainties propagate through all further computations aimed at estimating other aspects of the carbon dioxide system in a particular seawater sample. Furthermore, such results will include additional measurement uncertainties associated with the various equilibrium constants, and with other information such as the boron/salinity ratio, the total concentration of phosphate, etc.

The general relationship between the combined standard uncertainty  $u_c(y(x_1, x_2, \dots, x_n))$  of a value  $y$  and the uncertainties of the independent parameters  $x_1, x_2, \dots, x_n$  on which it depends is:

$$u_c(y(x_1, x_2, \dots, x_n)) = \sqrt{\sum_{i=1, n} \left( \frac{\partial y}{\partial x_i} \right)^2 u(x_i)^2} \quad (1.51)$$

where  $y(x_1, x_2, \dots, x_n)$  is a function of several parameters (Ellison *et al.*, 2000), and  $u(x_i)$  is the uncertainty in  $x_i$ . The various partial derivatives  $(\partial y / \partial x_i)$  can be estimated either algebraically (where convenient) or

## Part 1: Seawater carbonate chemistry

numerically. This is the approach that should be used to estimate the combined measurement uncertainty of an analytical measurement (see Ellison *et al.*, 2000).

In the case of the calculation of some aspect of the carbonate system (e.g.  $[\text{CO}_3^{2-}]$ ) from various combinations of the possible analytical parameters, alternate approaches are *not* necessarily equivalent. Dickson and Riley (1978) first pointed out the implications of uncertainties in the various analytical parameters (and in the equilibrium constants) in detail. They chose to rewrite equation (1.51) in terms of the *relative uncertainties*:

$$\frac{u_c(y(x_1, x_2, \dots, x_n))}{y} = \sqrt{\sum_{i=1, n} \left( \frac{\partial y}{\partial x_i} \frac{1}{y} \right)^2 \left( \frac{u(x_i)}{x_i} \right)^2}, \quad (1.52)$$

and their Table II provides values of the sensitivity coefficients  $\{(\partial y / y) / (\partial x_i / x_i)\}$  for a surface seawater. It is important to note that the values of these sensitivity coefficients, and similarly of the partial differentials  $(\partial y / \partial x_i)$ , are not constant but depend on the approximate composition of the seawater itself. For particular ocean acidification experiments (whose  $\text{CO}_2$  levels are likely to be significantly different from that of the seawaters used in Dickson and Riley) one should plan to estimate them numerically using a program such as CO2SYS.

The uncertainties in the values of the equilibrium constants and other ancillary data such as the boron to salinity ratio are often forgotten. Furthermore, it is usually not straightforward to use CO2SYS (or other easily available software) to estimate the likely contribution of these additional uncertainties. In that case, values provided by Dickson and Riley (1978) provide reasonable estimates of the sensitivity coefficients with respect to  $K_1$  and  $K_2$  (except perhaps when using the measurement pair  $A_T$  and DIC).

**Table 1.6** Estimated relative uncertainties\* in calculating  $[\text{CO}_2^*]$  and  $[\text{CO}_3^{2-}]$  (or saturation state) resulting from the measurement uncertainties in Table 1.4, and based on the sensitivity parameters calculated by Dickson & Riley (1978) for surface seawater. The uncertainties for the various equilibrium constants are assumed to be 0.01 in  $\log_{10}(K_1)$ ; 0.02 in  $\log_{10}(K_2)$ ; and 0.002 in  $\log_{10}(K_0)$ . RM: Reference materials.

Pair of parameters	Relative uncertainty	Reference methods	State-of-the-art (using RMs)*	Other techniques (using RMs)
pH, $A_T$	$u_c([\text{CO}_2^*]) / [\text{CO}_2^*]$ $u_c([\text{CO}_3^{2-}]) / [\text{CO}_3^{2-}]$	2.6% 3.6%	2.9% 3.7%	6.1-8.7% 5.1-6.5%
pH, DIC	$u_c([\text{CO}_2^*]) / [\text{CO}_2^*]$ $u_c([\text{CO}_3^{2-}]) / [\text{CO}_3^{2-}]$	2.4% 4.1%	2.6% 4.2%	5.6-8.0% 5.7-7.3%
$A_T$ , DIC	$u_c([\text{CO}_2^*]) / [\text{CO}_2^*]$ $u_c([\text{CO}_3^{2-}]) / [\text{CO}_3^{2-}]$	4.9% 0.6%	5.4% 1.7%	5.8-9.3% 2.2-5.5%
pH, $p(\text{CO}_2)$	$u_c([\text{CO}_2^*]) / [\text{CO}_2^*]$ $u_c([\text{CO}_3^{2-}]) / [\text{CO}_3^{2-}]$	0.6% 5.3%	0.8% 5.7%	1.5-2.9% 10.6-15.0%
$A_T$ , $p(\text{CO}_2)$	$u_c([\text{CO}_2^*]) / [\text{CO}_2^*]$ $u_c([\text{CO}_3^{2-}]) / [\text{CO}_3^{2-}]$	0.6% 3.3%	0.8% 3.3%	1.5-2.9% 3.4-3.8%
DIC, $p(\text{CO}_2)$	$u_c([\text{CO}_2^*]) / [\text{CO}_2^*]$ $u_c([\text{CO}_3^{2-}]) / [\text{CO}_3^{2-}]$	0.6% 4.0%	0.8% 4.1%	1.5-2.9% 4.2-4.9%

\*These values are certainly not accurate to two significant figures. However, one can easily see the implications of the estimated measurement uncertainties, and can also infer the importance of the uncertainties ascribed to the various equilibrium constants (which dominate the relative uncertainty when using methods with the lowest possible uncertainty).

The principal difficulty in performing a rigorous error propagation to estimate the overall uncertainty of, for example, saturation state is that it is often not straightforward to obtain the necessary information about the uncertainties  $u(x_i)$  of the various input data. The marine chemistry community has rarely attempted to estimate the combined standard uncertainty for the various measurement techniques discussed here, instead usually providing only precision information, and then often only data obtained under repeatability conditions, i.e. the variability within a single laboratory, over a short time, using a single operator, item of equipment, etc. This is necessarily *not* smaller than the combined standard uncertainty for a particular measurement technique (Ellison *et al.*, 2000). Table 1.4 provides (my personal) estimates of the measurement uncertainties associated with the various parameters. Table 1.6 uses these values, together with the sensitivity coefficients estimated by Dickson and Riley (1978) to calculate the relative uncertainties of  $[\text{CO}_2^*]$  and  $[\text{CO}_3^{2-}]$  resulting from the various possible pairs of parameters.

As can be seen, the likely relative uncertainty in estimating the concentration of unionised  $\text{CO}_2$ :  $[\text{CO}_2^*]$ , is always smallest if  $p(\text{CO}_2)$  is measured directly, and is otherwise of an approximately similar magnitude whichever parameter pair is chosen. Also, the relative uncertainty in  $[\text{CO}_3^{2-}]$  (or saturation state) is similar for different combinations, with the exception of pH and  $p(\text{CO}_2)$  where it is twice as large.

### 1.5.5 Advantages (and disadvantages) of different parameters

There are a variety of possible metrics for choosing suitable parameter combinations to characterise the seawater composition in an ocean acidification experiment. At present, I feel it is fair to say that there is not really an *optimal* choice of parameters. Here I briefly summarise the advantages and disadvantages of each parameter (prices are for 2009 and expressed in US dollars).

**Total alkalinity:** Equipment for this measurement can be purchased for \$10,000-20,000. It is relatively straightforward to use, though troubleshooting can be problematic. It typically has a stable calibration, and reference materials are available. Samples are easy to handle, as gas exchange is not typically a problem. The lowest uncertainty is obtained with sample sizes of about 100 ml, although it is practical to titrate samples that are as small as 15 ml without much difficulty. An analysis takes about 10–15 min in all. The most obvious disadvantage is that it is more difficult to interpret alkalinity accurately in samples with high concentrations of nutrients or of dissolved organic material. Reference materials are available.

**Total dissolved inorganic carbon:** Equipment for this measurement (using the infrared technique) can be purchased for \$40,000-50,000. It is relatively straightforward to use and quite quick (~10 min per sample), however the calibration is, in many cases, achieved using reference materials and is not highly stable. The sample size needed for analysis is small (<10 ml), however samples must be protected from gas exchange, particularly at higher  $p(\text{CO}_2)$ . Reference materials are available.

**pH:** Equipment for spectrophotometric pH measurement can be obtained for less than \$20,000. The procedure is relatively straightforward, and capable of some automation. It is necessary to minimise gas exchange when handling samples. The most obvious disadvantage at this time is the need for concern about the dye purity (Yao & Byrne, 2007), which causes the measurement uncertainty to be about 10 times its reproducibility. At this time, there are only limited amounts of pH reference materials available, though I hope my laboratory will be able to supply them in larger quantities in the future.

**$p(\text{CO}_2)$ :** Equipment for this measurement is typically quite expensive (about \$50,000). It usually requires a flowing stream of seawater and is calibrated using cylinders of air with known  $\text{CO}_2$  levels. It is cumbersome to set up, but can be relatively straightforward to use once running. One advantage is that such systems are usually designed to run autonomously.

At this time only pH and  $p(\text{CO}_2)$  can be used for continuous measurement allowing relatively straightforward monitoring of an experiment over time. However, if the experiment is arranged such that the alkalinity of the seawater remains constant (or nearly so), one need only monitor one of these continually, though it will be desirable to measure two parameters explicitly on any discrete samples taken to characterise the experiment.

At this time, I believe that the best combination of parameters for studying the  $\text{CO}_2$  system in open ocean water is probably total alkalinity and total carbon. It is straightforward to collect and preserve samples for later analysis, the equipment is reasonably readily available, and reference materials are also available to ensure metrological traceability. Also, there will be a close link to the extensive set of open-ocean studies that have been, and will be performed in the future.

Nevertheless, there are occasions when an alkalinity measurement will be difficult to interpret. In that case, I believe that the optimal combination of parameters is pH (measured spectrophotometrically) and total dissolved inorganic carbon (measured using infrared spectroscopy). These two parameters allow a description of the  $\text{CO}_2$  system alone (without concern as to other co-existing acid-base systems), equipment for making the measurements is available, and reference materials are also available (though pH reference materials are in shorter supply). This pair can also be applied to study normal seawaters and may well be the best all-round choice.

### 1.6 Conclusions and recommendations

As can be seen from the extensive discussion above, seawater acid base chemistry is necessarily complicated. It involves a variety of different acid-base species in addition to the three forms of carbon dioxide: dissolved carbon dioxide, bicarbonate ion, and carbonate ion. Although care has gone into defining and measuring the various equilibrium constants, the uncertainty of these is still discussed extensively (see for example Millero, 1995; Millero *et al.*, 2006).

At present there are four parameters that can be reliably measured for the seawater carbon dioxide system ( $A_T$ , DIC, pH,  $p(\text{CO}_2)$ ), and one of these, pH, has multiple possible definitions which in turn can result in multiple values for acid-dissociation constants (Dickson, 1984). This chapter follows the recommendation of the original *Handbook of methods for the analysis of the various parameters of the carbon dioxide system in seawater* (DOE, 1994) and of the more recent *Guide to best practices for ocean  $\text{CO}_2$  measurements* (Dickson *et al.*, 2007) and recommends use of the so-called *total hydrogen ion concentration scale* to define pH in seawater media. Values of equilibrium constants that correspond to this pH scale are given in Table 1.1.

The various equilibrium and mass-balance equations that describe the acid-base chemistry of seawater comprise a set of equations with a limited number of linearly independent variables (the rank of the system of equations). It is possible to obtain a complete description of the acid-base composition of a seawater sample at a particular temperature and pressure provided the following is known:

- the salinity and temperature, and hence the solubility constant of carbon dioxide in the seawater as well as the equilibrium constant for each of the acid dissociation reactions that is assumed to exist in the solution;
- the total concentrations for each of these non- $\text{CO}_2$  acid-base systems;
- the values for at least two of the  $\text{CO}_2$ -related parameters:  $A_T$ , DIC, pH,  $p(\text{CO}_2)$ .

At this time, the analytical methods described in the *Guide to best practices for ocean  $\text{CO}_2$  measurements* (Dickson *et al.*, 2007) are presently the best understood and have the lowest uncertainty. For studies on natural seawater, my recommendation would be to measure  $A_T$  and DIC (as samples for these can be preserved easily and the measurements made with low uncertainty). However, as was noted above, there may be samples from ocean acidification experiments where it is not possible to fully interpret an alkalinity measurement. In such cases, it is probably best to measure pH and DIC, and this combination is also acceptable for the study of ocean acidification in natural seawaters. However, in that case the uncertainty of the calculated parameters is typically dominated by the uncertainty in the (spectrophotometric) pH measurement, and a total carbon value obtained using a simpler system (such as one based on infrared measurement) is ideal.

Nevertheless, it is not – as yet – straightforward to make accurate measurements of seawater  $\text{CO}_2$  parameters. Most of the methods require trained analysts, and in many cases equipment is not easily available. At this time, it is probably desirable for individuals studying ocean acidification to plan to work closely with a scientist with a good understanding of seawater acid-base chemistry and with access



to a working laboratory that can perform the necessary measurements. Alternately, it may be practical to send samples to a central laboratory for analysis provided that such a laboratory has an appropriate quality assurance program in place, and can provide the results in a timely fashion.

As we move into the future, we need to develop robust analytical techniques that can be used conveniently for ocean acidification studies (involving in many cases smaller samples than are typical for open ocean studies). Although some such techniques already exist (Table 1.3), they still require additional efforts to document them effectively and to establish a community-wide quality assurance scheme for each technique. Such a scheme will involve:

1. writing appropriate Standard Operating Procedures for the techniques in use;
2. interlaboratory comparison exercises to assess the various figures of merit for each technique (trueness and precision);
3. regular use of certified reference materials to assist in the quality control;
4. regular laboratory performance testing using blind samples.

To date it is fair to state that few ocean acidification experiments have been conducted where scrupulous care has been directed at the – apparently straightforward – task of measuring the associated carbon dioxide chemistry. Although this may well not be the largest source of uncertainty in such experiments, it is appropriate to plan to control it effectively.

## 1.7 References

- Busenberg E. & Plummer L. N., 1989. Thermodynamics of magnesian calcite solid-solutions at 25°C and 1 atm total pressure. *Geochimica et Cosmochimica Acta* 53:1189-1208.
- Butler J. N. (with a Chapter by D. R. Cogley), 1998. *Ionic equilibrium: solubility and pH calculations* 559 p. New York: Wiley Interscience.
- Clayton T. D. & Byrne R. H., 1993. Spectrophotometric seawater pH measurements: total hydrogen ion concentration scale calibration of m-cresol purple and at-sea results. *Deep-Sea Research* 140:2115-2129.
- DelValls T. A. & Dickson A. G., 1998. The pH of buffers based on 2-amino-2-hydroxymethyl-1,3-propanediol ('tris') in synthetic sea water. *Deep-Sea Research* 145:1541-1554.
- Dickson A. G., 1993. The measurement of sea water pH. *Marine Chemistry* 44:131-142.
- Dickson A., 1981. An exact definition of total alkalinity and a procedure for the estimation of alkalinity and total inorganic carbon from titration data. *Deep-Sea Research* 28:609-623.
- Dickson A. G., Afghan J. D. & Anderson G. C., 2003. Reference materials for oceanic CO<sub>2</sub> analysis: a method for the certification of total alkalinity. *Marine Chemistry* 80:185–197.
- Dickson A. G. & Riley J. P., 1978. The effect of analytical error on the evaluation of the components of the aquatic carbon-dioxide system. *Marine Chemistry* 6:77-85.
- Dickson A. G. & Riley J. P., 1979. The estimation of acid dissociation constants in seawater media from potentiometric titrations with strong base. I. The ionic product of water. *Marine Chemistry* 7:89-99.
- Dickson A. G., Sabine C. L. & Christian J. R. (Eds), 2007. Guide to best practices for ocean CO<sub>2</sub> measurements. *PICES Special Publication* 3:1-191.
- Dickson A. G., 1984. pH scales and proton-transfer reactions in saline media such as sea-water. *Geochimica et Cosmochimica Acta* 48:2299-2308.
- Dickson A. G., Whitfield M. & Turner D. R., 1981. Concentration products: their definition, use and validity as stability constants. *Marine Chemistry* 10:559-565.
- DOE, 1994. Handbook of methods for the analysis of the various parameters of the carbon dioxide system in sea water. In: Dickson A. G. & Goyet C. (Eds.), Carbon Dioxide Information Analysis Center, Oak Ridge National Laboratory.
- Dux J. P., 1990. *Handbook of quality assurance for the analytical chemistry laboratory* 203 p. New York: Van Nostrand Reinhold Company.

- Ellison S. L. R., Rosslein M. & Williams A. (Eds), 2000. EURACHEM/CITAC Guide CG 4: Quantifying uncertainty in analytical measurement, 120 p.
- Goyet C. & Snover A. K., 1993. High-accuracy measurements of total dissolved inorganic carbon in the ocean - comparison of alternate detection methods. *Marine Chemistry* 44:235-242.
- Hernández-Ayón J. M., Zirino A., Dickson A. G., Camiro-Vargas T. & Valenzuela E., 2007. Estimating the contribution of organic bases from microalgae to the titration alkalinity in coastal seawaters *Limnology and Oceanography, Methods* 5:225-232.
- Kim H.-C. & Lee K., 2009. Significant contribution of dissolved organic matter to seawater alkalinity *Geophysical Research Letters* 36, L20603. doi:10.1029/2009GL040271.
- Lavigne H. & Gattuso J.-P., 2010. Seacarb: calculates parameters of the seawater carbonate system. R Package 2.3 (portions of code were contributed by J.-M. Epitalon, A. Hofmann, B. Gentili, J. Orr, A. Proye & K. Soetart). <http://cran.at.r-project.org/web/packages/seacarb/index.html>.
- Lewis E. & Wallace D. W. R., 1998. Program developed for CO<sub>2</sub> system calculations. Oak Ridge, Tennessee: ORNL/CDIAC-105. Carbon Dioxide Information Analysis Center, Oak Ridge National Laboratory, U.S. Department of Energy. <http://cdiac.ornl.gov/oceans/co2rprt.html>
- Millero F. J., 1995. Thermodynamics of the carbon dioxide system in the oceans *Geochimica et Cosmochimica Acta* 59:661-677.
- Millero F. J., Feistel R., Wright D. G. & McDougall T. J., 2008. The composition of standard seawater and the definition of the reference-composition salinity scale. *Deep-Sea Research* 155:50-72.
- Millero F. J., 2007. The marine inorganic carbon cycle. *Chemical Reviews* 107:308-341.
- Millero F. J., Graham T. B., Huang F., Bustos-Serrano H. & Pierrot D., 2006. Dissociation constants of carbonic acid in seawater as a function of salinity and temperature. *Marine Chemistry* 100:80-94.
- Morse J. W. & Arvidson R. S., 2002. The dissolution kinetics of major sedimentary carbonate minerals *Earth Science Reviews* 58:51-84.
- Morse J. W., Arvidson R. S. & Luttge A., 2007. Calcium carbonate formation and dissolution. *Chemical Reviews* 107:342-381.
- Neill C., Johnson K. M., Lewis E. & Wallace D. W. R., 1997. Accurate headspace analysis of fCO<sub>2</sub> in discrete water samples using batch equilibration. *Limnology and Oceanography* 42:1774-1783.
- Nemzer B. V. & Dickson A. G., 2005. The stability and reproducibility of Tris buffers in synthetic seawater *Marine Chemistry* 96:237-242.
- Pitzer K. S. & Brewer L., 1961. *Thermodynamics (revision of Lewis and Randall)*, 723 p New York: Mc Graw Hill.
- SCOR Working Group 75, 1992. Methodology for oceanic CO<sub>2</sub> measurements. *UNESCO technical papers in marine science* 75: 1-37.
- Soli A. L. & Byrne R. H., 2002. CO<sub>2</sub> system hydration and dehydration kinetics and the equilibrium CO<sub>2</sub>/H<sub>2</sub>CO<sub>3</sub> ratio in aqueous NaCl solution. *Marine Chemistry* 78:68-73.
- Taylor J. K., 1987. *Quality assurance of chemical measurements* 328 p. Chelsea, MI: Lewis Publishers, Inc.
- Thompson A. & Taylor B. N., 2008. Guide for the use of the International System of Units (SI). *NIST Special Publication 811* 1-85.
- Weiss R. F., 1974. Carbon dioxide in water and seawater: the solubility of a non-ideal gas *Marine Chemistry* 2:203-215.
- Weiss R. F. & Price B. A., 1980. Nitrous oxide solubility in water and seawater *Marine Chemistry* 8:347-359.
- Whitfield M., Butler R. A. & Covington A. K., 1985. The determination of pH in estuarine waters. I. Definition of pH scales and the selection of buffers. *Oceanologica Acta* 8:423-432.
- Wolf-Gladrow D. A., Zeebe R. E., Klaas C., Körtzinger A. & Dickson A. G., 2007. Total alkalinity: The explicit conservative expression and its application to biogeochemical processes *Marine Chemistry* 106:287-300.
- Yao W., Liu X. & Byrne R. H., 2007. Impurities in indicators used for spectrophotometric seawater pH measurements: assessment and remedies. *Marine Chemistry* 107:167-172.
- Zeebe R. E. & Wolf-Gladrow D. A., 2001. *CO<sub>2</sub> in seawater: equilibrium, kinetics, isotopes* 346 p. Amsterdam: Elsevier.

## 2 Approaches and tools to manipulate the carbonate chemistry

Jean-Pierre Gattuso<sup>1,2</sup>, Kunshan Gao<sup>3</sup>, Kitack Lee<sup>4</sup>, Björn Rost<sup>5</sup> and Kai G. Schulz<sup>6</sup>

<sup>1</sup>Laboratoire d'Océanographie, CNRS, France

<sup>2</sup>Observatoire Océanologique, Université Pierre et Marie Curie-Paris 6, France

<sup>3</sup>State Key Laboratory of Marine Environmental Science, Xiamen University, China

<sup>4</sup>Pohang University of Science and Technology, South Korea

<sup>5</sup>Alfred Wegener Institute for Polar and Marine Research, Germany

<sup>6</sup>Leibniz Institute of Marine Sciences (IFM-GEOMAR), Germany

### 2.1 Introduction

Although the chemistry of ocean acidification is very well understood (see chapter 1), its impact on marine organisms and ecosystems remains poorly known. The biological response to ocean acidification is a recent field of research, the first purposeful experiments have only been carried out as late as the 1980s (Agegian, 1985) and most were not performed until the late 1990s. The potentially dire consequences of ocean acidification have attracted the interest of scientists and students with a limited knowledge of the carbonate chemistry and its experimental manipulation. Perturbation experiments are one of the key approaches used to investigate the biological response to elevated  $p(\text{CO}_2)$ . Such experiments are based on measurements of physiological or metabolic processes in organisms and communities exposed to seawater with normal and altered carbonate chemistry. The basics of the carbonate chemistry must be understood to perform meaningful  $\text{CO}_2$  perturbation experiments (see chapter 1).

Briefly, the marine carbonate system considers  $\text{CO}_2^*(\text{aq})$  [the sum of  $\text{CO}_2$  and  $\text{H}_2\text{CO}_3$ ],  $\text{HCO}_3^-$ ,  $\text{CO}_3^{2-}$ ,  $\text{H}^+$ ,  $\text{OH}^-$ , and several weak acid-base systems of which borate-boric acid ( $\text{B}(\text{OH})_4^-$ ,  $\text{B}(\text{OH})_3$ ) is the most important. As discussed by Dickson (chapter 1), if two components of the carbonate chemistry are known, all the other components can be calculated for seawater with typical nutrient concentrations at given temperature, salinity, and pressure. One of the possible pairs is of particular interest because both components can be measured with precision, accuracy, and are conservative in the sense that their concentrations do not change with temperature or pressure. Dissolved inorganic carbon (DIC) is the sum of all dissolved inorganic carbon species while total alkalinity ( $A_T$ ) equals  $[\text{HCO}_3^-] + 2[\text{CO}_3^{2-}] + [\text{B}(\text{OH})_4^-] + [\text{OH}^-] - [\text{H}^+] + \text{minor components}$ , and reflects the excess of proton acceptors over proton donors with respect to a zero level of protons (see chapter 1 for a detailed definition).  $A_T$  is determined by the titration of seawater with a strong acid and thus can also be regarded as a measure of the buffering capacity. Any changes in any single component of the carbonate system will lead to changes in several, if not all, other components. In other words, it is not possible to vary a single component of the carbonate system while keeping all other components constant. This interdependency in the carbonate system is important to consider when performing  $\text{CO}_2$  perturbation experiments.

To adjust seawater to different  $p(\text{CO}_2)$  levels, the carbonate system can be manipulated in various ways that usually involve changes in  $A_T$  or DIC. The goal of this chapter is (1) to examine the benefits and drawbacks of various manipulation methods used to date and (2) to provide a simple software package to assist the design of perturbation experiments.

### 2.2 Approaches and methodologies

Seawater chemistry can be manipulated in various ways that alter the carbonate system differently. The following sections examine the five techniques that are most useful in the context of ocean acidification. To illustrate the discussions, each section below is followed by a numerical example. The R package *seacarb* was used to calculate the carbonate chemistry parameters (Lavigne & Gattuso, 2010) and the syntax used for

each example is available in Gattuso & Lavigne (2009). Note that other packages are available (see chapter 1). Calculations were carried out using the first and second dissociation constants of carbonic acid given by Lueker *et al.* (2000). In systems open to the atmosphere, it is assumed that the seawater and atmosphere are in equilibrium with respect to  $\text{CO}_2$  and the target  $p(\text{CO}_2)$  is the projected value for the year 2100 (Gattuso & Lavigne, 2009; Table 2.1).

**Table 2.1** Seawater carbonate chemistry in 2007, 2100, and after perturbations intended to simulate year 2100 carbonate chemistry (from Gattuso & Lavigne, 2009). Total alkalinity ( $A_T$ ), partial pressure of  $\text{CO}_2$  in seawater ( $p(\text{CO}_2)$ ), salinity and temperature were used to derive all other parameters using the seacarb package (Lavigne & Gattuso, 2010) except for manipulations of the calcium concentration for which DIC was used rather than  $p(\text{CO}_2)$ . Temperature (18.9°C) and salinity (34.9) were assumed to remain constant, the concentrations of total phosphate and silicate were set to 0 and the seawater  $p(\text{CO}_2)$  was set at 384  $\mu\text{atm}$  in 2007 and 793  $\mu\text{atm}$  in 2100. (a):  $\times 10^{-9}$  mol  $\text{kg}^{-1}$ , (b):  $\times 10^{-6}$  mol  $\text{kg}^{-1}$ .

	$p\text{CO}_{2,sw}$ ( $\mu\text{atm}$ )	$\text{pH}_T$ (–)	$[\text{H}^+]$ (a)	TA (b)	DIC (b)	$[\text{CO}_2]$ (b)	$[\text{HCO}_3^-]$ (b)	$[\text{CO}_3^{2-}]$ (b)	$\Omega_c$ (–)	$\Omega_a$ (–)
Year 2007	384	8.065	8.6	2325	2065	12.8	1865	187	4.5	2.9
Year 2100	793	7.793	16.1	2325	2191	26.4	2055	110	2.6	1.7
Gas bubbling	793	7.793	16.1	2325	2191	26.4	2055	110	2.6	1.7
Addition of high- $\text{CO}_2$ seawater	792	7.793	16.1	2325	2191	26.4	2055	110	2.6	1.7
Addition of $\text{CO}_3^{2-}$ and $\text{HCO}_3^-$ ; closed sys.	793	7.942	11.4	3406	3146	26.4	2901	218	5.2	3.4
Addition of $\text{CO}_3^{2-}$ and $\text{HCO}_3^-$ ; open sys.	384	8.207	6.2	3406	2950	12.8	2580	357	8.5	5.5
Acid addition; closed sys.	793	7.768	17.1	2184	2065	26.4	1940	98	2.3	1.5
Acid addition; open sys.	384	8.042	9.1	2184	194	12.8	1767	167	4	2.6
Addition of:										
$\text{CO}_3^{2-}$ and $\text{HCO}_3^-$ ; closed sys.	400	8.073	8.4	2467	2191	13.3	1977	201	4.8	3.1
followed by acid addition; closed sys.	793	7.793	16.1	2325	2191	26.4	2055	110	2.6	1.7
Manipulation of $[\text{Ca}^{2+}]$	384	8.065	8.6	2325	2065	12.8	1866	187	2.6	1.7

It must be pointed out that the methods described below enable one to set the carbonate chemistry at the beginning of a perturbation experiment. The impact of biological (e.g. photosynthesis, respiration and calcification) and physical processes (e.g. air-seawater exchange of  $\text{CO}_2$  and temperature changes) on the carbonate chemistry can distort the initial values and must be taken into account in the experimental design (see section 2.4.2).

There are several experimental approaches to adjust seawater  $\text{CO}_2$  by either changing DIC at constant  $A_T$  (e.g. aeration with air at target  $p(\text{CO}_2)$ ), injections of  $\text{CO}_2$  saturated seawater and combined additions of  $\text{NaHCO}_3$  or  $\text{Na}_2\text{CO}_3$  and  $\text{HCl}$  or changing  $A_T$  at constant DIC ( $\text{NaOH}$  and/or  $\text{HCl}$  additions). Each experiment has different requirements depending on organisms, experimental duration, incubation volumes or sampling intervals and hence one of the possible carbonate chemistry manipulations will probably be favoured.

## 2.2.1 Changing DIC at constant $A_T$

### *Aeration at target $p(\text{CO}_2)$*

Bubbling seawater with gases is a very efficient way to manipulate its carbonate chemistry. The seacarb function *pgas* estimates the changes in the carbonate chemistry resulting from changes generated by bubbling gases.

**Example:** seawater with  $p(\text{CO}_2)$  of 384  $\mu\text{atm}$  and an  $A_T$  of 2325  $\mu\text{mol kg}^{-1}$  can be bubbled with a mixture of  $\text{CO}_2$  and air with a  $p(\text{CO}_2)$  of 793  $\mu\text{atm}$ . Salinity is 34.9, temperature is 18.9°C and calculations are done for surface waters. This approach exactly reproduces the values of all parameters of the carbonate system expected in the year 2100 (Table 2.1).

Two aeration techniques have been used in ocean acidification studies: pH-stat and bubbling with premixed gases. In pH-stat systems, pH is monitored continuously and a controller opens or closes the valves that deliver the gases when pH goes above or below a set value. Gases are then delivered until pH reaches the target value again. Different combinations of gases have been used: (1) air and pure CO<sub>2</sub>, (2) CO<sub>2</sub>-free air and pure CO<sub>2</sub> and (3) air, CO<sub>2</sub>-free air and pure CO<sub>2</sub>. CO<sub>2</sub>-free air can be produced easily using either molecular sieves or CO<sub>2</sub> scrubbers such as soda lime or NaOH and Ca(OH)<sub>2</sub> (C. Hintz, pers. comm.). The pH threshold is calculated using the desired p(CO<sub>2</sub>) and total alkalinity which is either assumed to be constant or frequently measured. This method has the potential to compensate for changes in the carbonate chemistry due to photosynthesis and respiration or, in the case of open culture systems, to changes in the chemistry of the source water. However, the air-water gas exchange and CO<sub>2</sub> hydration is relatively slow and the system may not reach equilibrium when there is high biological activity (high biomass to volume ratio). Like with other approaches, it does not compensate for changes in total alkalinity resulting from the precipitation and dissolution of CaCO<sub>3</sub> that occur between measurements of total alkalinity.

Overall, the carbonate chemistry can be maintained with good efficiency in the culture vessel, for example p(CO<sub>2</sub>) can be controlled usually better than ±10 µatm. The main drawback of this technique is that the pH electrode must be frequently calibrated in order to correct for drift. Hence, the technique that involves bubbling with premixed gases may be attractive. Air with the desired p(CO<sub>2</sub>) can be produced using gas mixing pumps or purchased. Another technique would be to maintain atmospheric p(CO<sub>2</sub>) to the desired level in the laboratory or in the growth cabinets in which the experiments are carried out (such cabinets for maintaining terrestrial plant are commercially available). A simple air pump can then be used to bubble the experimental seawater. To the best of our knowledge, this technique has not yet been used in the context of ocean acidification.

Aeration of seawater should be used with care for two reasons. First, bubbling may enhance the surface coagulation of organic matter (Engel *et al.*, 2004). This may be critical for studies investigating the response of microbial communities since their metabolism depends on the respective abundance of dissolved and particulate organic matter. This drawback may be avoided by enclosing the community in a dialysis bag maintained in a container bubbled with a gas of the desired p(CO<sub>2</sub>) (M. G. Weinbauer, pers. comm.). Such bags are permeable to gases and small molecules but impermeable to larger molecules and particles. It is highly recommended to check that the membranes are chemically neutral as some materials leak unwarranted chemical compounds. Second, some species of phytoplankton, for instance dinoflagellates, are known to be negatively affected by turbulence and especially by continuous bubbling (Shi *et al.*, 2009). For those cases, it is useful to equilibrate the media to the desired p(CO<sub>2</sub>) level prior to the inoculation or use other means to achieve a carbonate system close to reality, i.e. where DIC varies and A<sub>T</sub> remains constant.

#### ***Addition of high-CO<sub>2</sub> seawater***

DIC and A<sub>T</sub> are conservative quantities with respect to mixing (Wolf-Gladrow *et al.*, 2007). Hence, when two water parcels are mixed, the amount of a solute in the mixture equals the sum of the amounts of this solute in the two initial water parcels. The seacarb function *pmix* estimates the carbonate chemistry after mixing of two water samples.

**Example:** one can mix, in a closed system, 0.99623 kg of seawater having an A<sub>T</sub> of 2325 µmol kg<sup>-1</sup>, and p(CO<sub>2</sub>) of 384 µatm with 0.00377 kg of seawater having an A<sub>T</sub> of 2325 µmol kg<sup>-1</sup> and saturated with CO<sub>2</sub> (p(CO<sub>2</sub>) = 1 × 10<sup>6</sup> µatm). The weight fraction of the high-CO<sub>2</sub> seawater relative to the final weight is 3.76 × 10<sup>-3</sup>. Salinity is 34.9, temperature is 18.9°C and calculations are made for surface waters. This produces seawater with a final p(CO<sub>2</sub>) of 793 µatm and all parameters of the projected carbonate chemistry in 2100 are perfectly reproduced.

To the best of our knowledge, this approach has been used only twice. To create a p(CO<sub>2</sub>) range from 200 to 1300 µatm, Schulz *et al.* (unpubl.) added about 20 to 200 dm<sup>3</sup> of seawater enriched in CO<sub>2</sub> to 60 m<sup>3</sup> mesocosms (Figure 2.1). C. McGraw (pers. comm., 2009) used this technique in laboratory experiments. As this approach uses water with very high p(CO<sub>2</sub>), caution has to be taken to avoid gas exchange during mixing and handling.



**Figure 2.1** Aeration system for seawater carbon dioxide ( $\text{CO}_2$ ) enrichment consisting of a bottle of pure  $\text{CO}_2$  gas and two 250 l seawater containers (photo credit: K. Schulz).

### *Addition of strong acid as well as $\text{CO}_3^{2-}$ and/or $\text{HCO}_3^-$*

As will be outlined below, the addition of acid alone does not fully mimic the changes in carbonate chemistry expected during the present century. The addition of  $\text{CO}_3^{2-}$  and/or  $\text{HCO}_3^-$  followed by acid circumvents this problem. The first addition elevates DIC to the desired level and the acid addition (at constant DIC) precisely cancels the increase in  $A_T$  resulting from the addition of  $\text{CO}_3^{2-}$  and/or  $\text{HCO}_3^-$ .

**Example:**  $\text{HCO}_3^-$  ( $111.2 \mu\text{mol kg}^{-1}$  of  $\text{NaHCO}_3$ ) and  $\text{CO}_3^{2-}$  ( $15.3 \mu\text{mol kg}^{-1}$  of  $\text{Na}_2\text{CO}_3$ ) can be added to seawater for which  $p(\text{CO}_2)$  ( $384 \mu\text{atm}$ ) and  $A_T$  ( $2325 \mu\text{mol kg}^{-1}$ ) are known, salinity is 34.9, temperature is  $18.9^\circ\text{C}$  and calculations are done for surface waters. Then,  $14.18 \text{ ml kg}^{-1}$  of 0.01 N HCl is added. The first addition raises DIC to the desired level of  $2191 \mu\text{mol kg}^{-1}$  but increases  $A_T$  to a value higher than target ( $2467$  vs.  $2325 \mu\text{mol kg}^{-1}$ ; Table 2.1). The subsequent addition of HCl, in a closed system to prevent gas exchange, restores  $A_T$  to the desired value without affecting DIC. All carbonate parameters after both additions reach the target values.

### 2.2.2 Addition of strong acids and bases

The addition of a strong acid, such as HCl, or base, such as NaOH, in a system closed to the atmosphere does not alter the concentration of dissolved inorganic carbon but modifies total alkalinity.  $A_T$  decreases following addition of an acid whereas it increases following addition of a base. The change in total alkalinity after addition of a strong acid or base in a system open to the atmosphere is identical to that described above for a closed system. However, the concentration of DIC is modified through  $\text{CO}_2$  exchange at the air-water interface. The seacarb function *ppH* estimates the changes in the carbonate chemistry during pH manipulations. The change in salinity due to the addition of acid or base is minor and can therefore be neglected.

**Example:** a volume of  $14.08 \text{ ml}$  of 0.01 N HCl is added to  $1 \text{ kg}$  of seawater with known  $p(\text{CO}_2)$  ( $384 \mu\text{atm}$ ) and  $A_T$  ( $2325 \mu\text{mol kg}^{-1}$ ); the atmospheric  $p(\text{CO}_2)$  is  $384 \mu\text{atm}$ , salinity is 34.9, temperature is  $18.9^\circ\text{C}$  and calculations are done for surface waters. The target  $p(\text{CO}_2)$  of  $793 \mu\text{atm}$  is reached in a closed system (Table 2.1) but the pH is lower than the value expected in 2100 ( $7.768$  vs  $7.793$ , corresponding to a 2.9 % increase in  $[\text{H}]$  that results from the decrease in total alkalinity generated by acid addition). This is an undesirable effect of the direct manipulation of pH, as  $A_T$  will not change significantly during the course of this century. As a result, DIC,  $\text{HCO}_3^-$ ,  $\text{CO}_3^{2-}$  and the  $\text{CaCO}_3$  saturation states are lower than their target values. However, it is possible to restore  $A_T$  to its initial level by adding  $\text{CO}_3^{2-}$  and  $\text{HCO}_3^-$ , an approach that is described above.

### 2.2.3 Addition of $\text{CO}_3^{2-}$ and/or $\text{HCO}_3^-$

DIC and  $A_T$  can be increased by adding  $\text{CO}_3^{2-}$  in the form of  $\text{Na}_2\text{CO}_3$  and/or by adding  $\text{HCO}_3^-$  in the form of  $\text{NaHCO}_3$ . In closed systems, the change in DIC generated by these additions is proportional to the changes in concentration:  $1 \times \Delta[\text{CO}_3^{2-}]$  and  $1 \times \Delta[\text{HCO}_3^-]$ . The contribution of these anions to  $A_T$  is proportional to the product of their charge and concentration. Thus,  $A_T$  increases by  $2 \times \Delta[\text{CO}_3^{2-}]$  and  $1 \times \Delta[\text{HCO}_3^-]$ . The changes in the carbonate chemistry generated by manipulations of total alkalinity therefore depend on the proportion of  $\text{CO}_3^{2-}$  and  $\text{HCO}_3^-$  added. This approach can be used to hold pH constant or be combined with acid addition to maintain  $A_T$  constant (see section 2.2.1).

The seacarb function  $pTA$  estimates the changes in the carbonate chemistry following addition of  $\text{CO}_3^{2-}$  and/or  $\text{HCO}_3^-$ . In an open system, the carbonate system re-equilibrates through air-sea  $\text{CO}_2$  gas exchange after the addition of chemicals but  $A_T$  remains at a level higher than the target value.

**Example:**  $\text{HCO}_3^-$  ( $1081 \mu\text{mol kg}^{-1}$  of  $\text{NaHCO}_3$ ) is added to seawater for which  $p(\text{CO}_2)$  ( $384 \mu\text{atm}$ ) and  $A_T$  ( $2325 \mu\text{mol kg}^{-1}$ ) are known. No  $\text{CO}_3^{2-}$  is added, the atmospheric  $p(\text{CO}_2)$  is  $384 \mu\text{atm}$ , salinity is 34.9, temperature is  $18.9^\circ\text{C}$  and calculations are done for surface waters. Results are shown in Table 2.1. In a closed system, the target  $p(\text{CO}_2)$  of  $793 \mu\text{atm}$  is reached but all other parameters of the carbonate system are very different from their values expected in 2100. pH is lower than it should be (7.942 vs. 7.993) and  $A_T$ , DIC,  $[\text{CO}_3^{2-}]$  as well as the saturation states of aragonite ( $\Omega_a$ ) and calcite ( $\Omega_c$ ) are higher than the target values and are even higher than the values of the initial seawater. Differences are magnified in open systems.

### 2.2.4 Manipulation of the $\text{Ca}^{2+}$ concentration

Although manipulating the calcium concentration is not technically altering the carbonate chemistry *per se*, this approach has been used in the context of ocean acidification. The reason is that some calcifying organisms, such as corals, respond to the calcium carbonate saturation state of seawater  $\Omega$  which is expressed as:

$$\Omega = \frac{[\text{Ca}^{2+}][\text{CO}_3^{2-}]}{K_{\text{sp}}^*}, \quad (2.1)$$

where  $[\text{Ca}^{2+}]$  and  $[\text{CO}_3^{2-}]$  are the concentrations of calcium and carbonate ions in seawater, respectively, and  $K_{\text{sp}}^*$  is the solubility product at the *in situ* conditions of temperature, salinity and pressure (Zeebe & Wolf-Gladrow, 2001). It can readily be appreciated that the changes in  $\Omega$  resulting from a decrease in  $[\text{CO}_3^{2-}]$  driven by ocean acidification can be mimicked by altering  $[\text{Ca}^{2+}]$ . Uncoupling  $\Omega$  from the carbonate chemistry can also be useful, for instance, to examine a possible dependence of photosynthesis on calcification (Gattuso *et al.*, 2000; Trimbom *et al.*, 2007). It is also useful to replenish calcium when its concentration decreases below its natural levels during long-term experiments with calcifiers (Langdon *et al.*, 2000).

The seacarb function  $pCa$  estimates the changes in  $\Omega_c$  and  $\Omega_a$  resulting from the manipulation of the concentration of  $\text{Ca}^{2+}_{\text{sw}}$ . It is recommended to use the simplified recipe for synthetic seawater based on DOE (1994) described by Gattuso *et al.* (1998) because it is the basis of the synthetic seawater that has been used to determine a variety of equilibrium constants for use in seawater. Note that the effect of the changes in the calcium concentration on the dissociation constants of carbonic acid and on the solubility product of  $\text{CaCO}_3$  may have to be considered (Ben-Yaakov & Goldhaber, 1973).

**Example:** artificial seawater with a known  $A_T$  ( $2325 \mu\text{mol kg}^{-1}$ ) and ( $2064 \mu\text{mol kg}^{-1}$ ) and with a calcium concentration set to  $6.03 \mu\text{mol kg}^{-1}$  reproduces well the saturation states of aragonite and calcite expected in 2100 without affecting any of the other parameters of the carbonate system which remain at their 2007 values (Table 2.1).

## 2.3 Strengths and weaknesses

The seacarb function  $oa$  (Lavigne & Gattuso, 2010) describes the various approaches that can be used to alter the seawater carbonate system. It provides precise guidelines on how the target carbonate chemistry can be reached as well as a plot showing, in the  $A_T$  vs. DIC space, the changes generated by the five main perturbation techniques.

It can readily be seen from Figure 2.2 and Table 2.1 that three approaches closely mimic the on-going and future changes in the seawater carbonate chemistry: gas bubbling, addition of high- $\text{CO}_2$  seawater, and combined additions of acid and bicarbonate and/or carbonate. All three methods increase dissolved inorganic carbon at constant total alkalinity, a situation that closely resembles the changes in the carbonate chemistry that occurred during the past 200 years and are expected to continue in the next few hundreds years. All three approaches therefore allow precise control of all carbonate parameters to reach target values at the beginning of a perturbation experiment. Gas bubbling is the easiest to implement and can be used to maintain constant conditions over long periods of time. Note that, in all approaches, biological processes (e.g. photosynthesis, respiration, calcification, dissolution of  $\text{CaCO}_3$ , nutrient uptake and release) can significantly distort the target carbonate chemistry by changing DIC and  $A_T$  when experiments are run with high biomass (Rost *et al.*, 2008). Gas bubbling can maintain the concentration of DIC constant, provided that the dissolution of  $\text{CO}_2$  is faster than its biological uptake, but does not compensate the drift in  $A_T$ . Also, in all three methods, in addition to  $A_T$ , calcification can also deplete the concentration of  $\text{Ca}^{2+}$  when the organism to volume ratio is high or the incubation time is long.

The approach that adds  $\text{CO}_3^{2-}$  and/or  $\text{HCO}_3^-$  appears of limited practical value because most carbonate chemistry variables deviate from target values. Obviously, due to gas exchange at the air-water interface, only gas bubbling can successfully be used to adjust  $p(\text{CO}_2)$  and other parameters of the carbonate chemistry in an open system.

Several studies have used acid addition to manipulate the carbonate chemistry. Although this technique enables to precisely control  $p(\text{CO}_2)$  in systems closed to the atmosphere, it also alters  $A_T$  which results in carbonate parameters which are different from those expected in the future: pH is lower than its target value, DIC remains unchanged (whereas it increases under natural ocean acidification), and the concentrations of bicarbonate and carbonate as well as  $\text{CaCO}_3$  saturation states are lower than expected. Gattuso & Lavigne (2009) and Schulz *et al.* (2009) provide a detailed analysis of the similarities and differences between acid addition and DIC manipulations. It is recommended to combine the addition of bicarbonate and/or carbonate, to increase DIC, with acid addition to avoid this drawback.

Iglesias-Rodriguez *et al.* (2008a) recently reported that, in contrast to all previous reports, calcification of coccolithophorids increases at elevated  $p(\text{CO}_2)$ . They argued that this is due to the approaches used to manipulate the carbonate chemistry and that the approach of gas bubbling is superior to that of acid addition (Iglesias-Rodriguez *et al.*, 2008a and 2008b). The argument is that acid addition does not reproduce the increase of the  $\text{HCO}_3^-$  concentration generated by natural ocean acidification whereas gas bubbling does. The authors claim that since  $\text{HCO}_3^-$  may stimulate photosynthesis and, in turn, calcification, experiments that used acid addition and demonstrated that calcification declines at lower pH, confounded the issue. This statement is misleading, although there is no doubt that gas bubbling better mimics the future carbonate chemistry (Table 2.1). Several previous perturbation experiments were carried out with gas bubbling and also reported lower rates of calcification of coccolithophores at lower pH or higher  $p(\text{CO}_2)$  (e.g. Sciandra *et al.*, 2003; Delille *et al.*, 2005; Feng *et al.*, 2008). It should also be pointed out that perturbation experiments carried out using gas bubbling can, like all other approaches, also lead to poor control of the carbonate chemistry, for example when the duration of the experiments is too long, when experiments are run at high biomass, or when the DIC uptake is larger than the dissolution of  $\text{CO}_2$  (see above). It therefore seems that the different responses of coccolithophores reported in the literature do not originate from the approach used to manipulate the carbonate chemistry. The situation is clearer in reef-building corals as Schneider & Erez (2006) measured the rate of calcification under constant DIC, constant pH and constant  $p(\text{CO}_2)$  and showed that calcification is controlled by the concentration of  $\text{CO}_3^{2-}$ , the future value of which is relatively well mimicked by acid addition.

## 2.4 Potential pitfalls and suggestions for improvements

### 2.4.1 Seawater filtration and autoclaving

As filtration can significantly shift the carbonate chemistry of seawater, the carbonate system should be manipulated after filtration. If this cannot be done, samples for carbonate chemistry determination must be



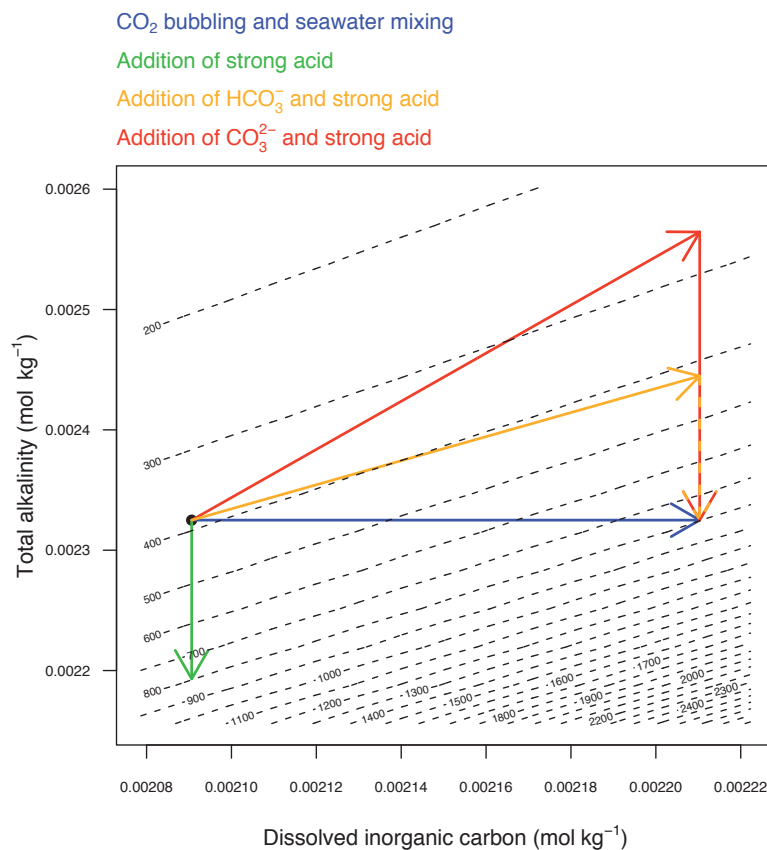

**Figure 2.2** Changes in the carbonate chemistry generated by various perturbation techniques, in the  $A_T$  vs. DIC space. The plot was generated using the seacarb function  $oa$ .

taken after filtration to account for any gas exchange. Gentle pressure filtration through a cartridge should be performed because vacuum filtration or strong pressure filtration alter  $p(\text{CO}_2)$  and DIC (see Grasshoff *et al.*, 1999) and could lead to cell rupture, which in turn increases total alkalinity.

Seawater autoclaving should also be performed prior to manipulating the carbonate chemistry. It can severely change the carbonate chemistry as boiling seawater strips off gases and most of the DIC is lost.  $A_T$  has been reported to change as well: it increases, together with salinity, due to water evaporation but can also decrease due to precipitation of carbonate. Overall, the  $p(\text{CO}_2)$  of autoclaved water is initially relatively low and pH quite high. When the seawater cools, some of the DIC is likely to re-dissolve from the headspace into the water phase. When autoclaving natural seawater, it is recommended to sample for DIC and  $A_T$  determinations before and after autoclaving in order to ascertain the impact of the operating procedure on the carbonate chemistry. In case of artificial seawater, autoclaving will not change the carbonate chemistry if it is carried out before the addition of  $\text{NaHCO}_3$  or  $\text{Na}_2\text{CO}_3$ .

#### 2.4.2 Reaching and maintaining target values

When seawater is manipulated via bubbling with gases of different  $p(\text{CO}_2)$ , one must ascertain that equilibrium has been reached before starting an experiment. The required time to reach equilibrium depends on several factors such as the biomass to volume ratio,  $p(\text{CO}_2)$ , gas flow rate, bubble size, volume and shape of the flask and temperature, and may require several days. Since both bottled gas mixtures and  $\text{CO}_2$ -free air from generators do not contain any water vapour, it is important to humidify the dry air

before bubbling in order to avoid evaporation that would increase salinity, itself leading to changes in the parameters of the carbonate system.

Once the carbonate chemistry has reached a target level, it is critical to avoid any process leading to gas exchange between seawater and the atmosphere such as autoclaving, vacuum filtration or temperature changes. Unless the experimental set-up is open and bubbling is running continuously, gas-tight bottles filled without headspace should be used.

When working with high cell densities, processes such as photosynthesis and calcification can severely shift the carbonate chemistry. This problem is most pronounced in closed systems but must also be considered in open systems subject to continuous bubbling because biologically-driven changes can exceed the capability of the regulation system and thus cause a departure from the desired carbonate chemistry. This problem is more pronounced when investigating calcifying systems because calcification decreases  $A_T$ . The drawdown of  $\text{Ca}^{2+}$  associated to the decline of  $A_T$  might also need to be considered as it could also impact on the  $\text{CaCO}_3$  saturation state.

### 2.4.3 Contributions of dissolved organic matter, dissolved inorganic nutrients and pH buffers to total alkalinity

During photosynthesis, phytoplankton release dissolved organic compounds containing basic functional groups that readily react with protons during seawater titration, and thereby contribute to total alkalinity. The magnitude of the contribution of dissolved organic compounds to  $A_T$  depends on the species and on the age of the culture, suggesting that individual phytoplankton species exude dissolved organic compounds with unique proton accepting capacities (Kim & Lee, 2009). This contribution could be significant in perturbation experiments carried out at relatively high biomass:volume ratios. In that case, which must be avoided in perturbation experiments, one might consider the use of calculated carbonate parameters (e.g. total alkalinity derived from pH and DIC or from  $\text{p}(\text{CO}_2)$  and DIC) rather than the measured total alkalinity.

Some salts, such as inorganic nutrients, must be considered in experiments manipulating the carbonate chemistry as they contribute to  $A_T$ . The use of pH buffers causes large deviations from the natural carbonate chemistry as they increase  $A_T$  to values too high for accurate measurements and therefore precludes the calculation of the carbonate system using  $A_T$ , DIC and pH or  $\text{p}(\text{CO}_2)$  then have to be used instead. Depending on chemical form and concentration, inorganic nutrient addition can change  $A_T$  and should be included in carbonate chemistry calculations. Furthermore, possible changes of experimental inorganic nutrient concentrations and speciation, and their impact on  $A_T$  (for details see Brewer & Goldman (1976); Wolf-Gladrow *et al.* (2007)) highlight the importance of concomitant sampling for nutrients such as phosphate, ammonium and silicate, together with those for carbonate chemistry determination.

Phosphate ( $\text{PO}_4^{3-}$ ) is usually added to seawater as the sodium salt  $\text{NaH}_2\text{PO}_4 \cdot \text{H}_2\text{O}$  (see Guillard & Ryther, 1962). Its addition does not alter  $A_T$  as the immediate dissociation products  $\text{Na}^+$  and  $\text{H}_2\text{PO}_4^-$  do not contribute to  $A_T$  (see equation 1.50). In fact, since the other three phosphate species ( $\text{H}_3\text{PO}_4$ ,  $\text{HPO}_4^{2-}$ ,  $\text{PO}_4^{3-}$ ; equation 1.50) are included in  $A_T$ , the addition of  $\text{NaH}_2\text{PO}_4 \cdot \text{H}_2\text{O}$  do increase the alkalinity contribution by phosphate but concomitantly reduces the contribution of other  $A_T$  components by the same amount (equation 1.43). However, if phosphate is added as phosphoric acid ( $\text{H}_3\text{PO}_4$ ), total alkalinity is reduced by one mole per mole of phosphoric acid added. Hence, when calculating carbonate system speciation from measured  $A_T$ , the phosphate contribution should be taken into account. However, the error made by ignoring the contribution of phosphate to  $A_T$  is negligible at concentrations below  $1 \mu\text{mol kg}^{-1}$ .

Nitrate ( $\text{NO}_3^-$ ) is usually added to seawater as the sodium salt  $\text{NaNO}_3$  which does not alter  $A_T$ . Furthermore, as nitrate has no  $A_T$  component, it does not need to be considered when calculating the carbonate system from  $A_T$  measurements. However, the addition of nitric acid ( $\text{HNO}_3$ ) decreases  $A_T$ . Ammonia is usually added as ammonium chloride ( $\text{NH}_4^+$ ), which does not change  $A_T$ . Nevertheless, since  $\text{NH}_3$  contributes to  $A_T$ , it must be considered in carbonate chemistry calculations. In practice it can probably be ignored in most cases because of its relatively low concentration.

Silica in the form of  $\text{H}_4\text{SiO}_4$  is generally added as the sodium salt  $\text{Na}_2\text{SiO}_3 \cdot 9\text{H}_2\text{O}$ . This changes  $A_T$  as  $\text{SiO}_3^{2-}$  combines with  $\text{H}_2\text{O}$  to form  $\text{H}_2\text{SiO}_4^{2-}$ , which quickly converts to  $\text{H}_3\text{SiO}_4^-$  by consuming a proton. At seawater pH, most of the  $\text{H}_3\text{SiO}_4^-$  further converts to  $\text{H}_4\text{SiO}_4$ , consuming another proton. Therefore,  $A_T$  increases by two moles for each mole of  $\text{Na}_2\text{SiO}_3$  added. Additions of silica to either natural seawater or artificial seawater can be relatively high, in the  $100 \mu\text{mol kg}^{-1}$  range. In these cases it might be advisable to counterbalance the otherwise relatively large increase of  $A_T$  by additions of HCl. As  $\text{H}_3\text{SiO}_4^-$  contributes to  $A_T$ , it should be included in the carbonate system calculations, although in many cases it can safely be ignored due to its relatively low concentrations at typical seawater pH (see Zeebe & Wolf-Gladrow, 2001).

#### 2.4.4 Isotopic labelling of dissolved inorganic carbon

Labelling of the dissolved inorganic carbon (DIC) pool with  $^{13}\text{C}$  or  $^{14}\text{C}$  requires the same precautions during preparation and handling as described above for the carbonate chemistry. In fact, it is a carbonate chemistry manipulation in itself and hence should be the last step in the preparation of an experiment. Any headspace should be avoided as seawater-atmosphere  $\text{CO}_2$  gas exchange reduces the concentration of the label.

Even if seawater is close to ambient  $p(\text{CO}_2)$ , any  $^{13}\text{C}$  or  $^{14}\text{C}$  added would outgas with time, driven by the difference in seawater and atmosphere  $^{13}\text{CO}_2$  or  $^{14}\text{CO}_2$  as their respective atmospheric partial pressures are close to 0: about  $4 \mu\text{atm}$  for  $^{13}\text{CO}_2$  and  $1 \times 10^{-13} \mu\text{atm}$  for  $^{14}\text{CO}_2$  (calculated according to Coplen *et al.* (2002) and Nydal & Lövseth (1996)). Therefore, aeration of seawater with air at target  $\text{CO}_2$  would increase  $^{13}\text{C}$  or  $^{14}\text{C}$  outgassing even though  $p(\text{CO}_2)$  would be kept constant. Furthermore, depending on the amount of  $^{13}\text{C}$  or  $^{14}\text{C}$  sodium salts added, DIC and  $A_T$  and hence  $p(\text{CO}_2)$  can change significantly.

#### 2.4.5 Sampling of carbonate chemistry parameters

Measuring and reporting of at least two quantities of the carbonate system prior to, after and ideally during experiments will ensure constant conditions or reveal possible shifts. Discrete samples for determination of DIC or pH should be taken with care because  $\text{CO}_2$  gas exchange between sample water and atmosphere could otherwise compromise the measurements. Sampling for  $A_T$  measurements, however, is not critically influenced by changes in DIC or pH related to gas exchange. Even if the water were stripped of any dissolved inorganic carbon, for example by warming the sample,  $A_T$  would stay constant provided that there is no evaporation and that salinity remains the same.

Samples should be poisoned for storage (see Grasshoff *et al.* (1999) and Dickson *et al.* (2007) for details) and kept at low temperatures before analysis. Headspace within DIC or pH sample vials must be avoided. Depending on organism and experimental setup, DIC and  $A_T$  measurements should be performed on filtered seawater. For instance, phytoplankton cells grown to relatively high densities in comparison to oceanic waters, can disintegrate during  $A_T$  or DIC measurements because of necessary acid additions. This could release  $A_T$  or DIC components from the particulate to the dissolved phase and compromise analysis. Furthermore, negatively charged groups in cellular plasma membranes can absorb protons added during  $A_T$  titration, thereby compromising the measurement (Kim *et al.*, 2006). Similarly, the study of calcifying organisms can also make DIC and  $A_T$  filtration necessary because  $\text{CaCO}_3$  dissolves during measurements due to acid additions, which artificially increases both DIC and  $A_T$ . Filtration of DIC samples must be carried out with care to avoid water-atmosphere  $\text{CO}_2$  gas exchange.

#### 2.4.6 Headspace and storage

Seawater in which the carbonate system has been manipulated and that is to be used in experiments should be handled very carefully. Wherever possible, headspace should be avoided as concentrations and speciation will otherwise change through water-atmosphere  $\text{CO}_2$  gas exchange if seawater  $p(\text{CO}_2)$  differs from atmospheric  $p(\text{CO}_2)$  (current atmospheric values are about  $390 \mu\text{atm}$  while those inside closed rooms are usually higher). An exception is seawater that is constantly aerated at target  $p(\text{CO}_2)$  throughout the experiment. Nevertheless, frequent sampling for at least two carbonate chemistry parameters is necessary for quality control.

Likewise, when storing manipulated seawater prior to the experiment, there should be no headspace. In this respect, it is important to keep in mind that temperature variations will change the carbonate chemistry. For instance, cooling seawater will initially decrease  $p(\text{CO}_2)$ , while increasing pH. If there is no headspace and the seawater is afterwards adjusted to intended temperatures, the carbonate system will shift back to pre-set conditions. This would not be the case if the water were stored with a headspace. The same applies for seawater that was aerated at target  $\text{CO}_2$ . If aeration is carried out at different temperatures than experimental incubation,  $p(\text{CO}_2)$  and hence carbonate chemistry speciation will change.

## 2.5 Data reporting

It is essential to report not only on the results obtained, but also on the methods used. The metadata should be included in databases (see chapter 15) in order to enable comparisons of different studies and meta-analysis. Table 2.2 provides a checklist of the information on the manipulation of the carbonate chemistry that should be reported when describing a perturbation experiment

**Table 2.2** Checklist of the information on the manipulation of the carbonate chemistry that should be reported when describing a perturbation experiment.

Method used to manipulate the carbonate chemistry	<p>Which of the methods below was used:</p> <ul style="list-style-type: none"> <li>– Aeration with air at target <math>p(\text{CO}_2)</math> (indicate <math>p(\text{CO}_2)</math> level and flow rate).</li> <li>– Addition of high-<math>\text{CO}_2</math> seawater (indicate <math>p(\text{CO}_2)</math> and mixing ratio).</li> <li>– Addition of strong acid as well as <math>\text{CO}_3^{2-}</math> and/or <math>\text{HCO}_3^-</math> (indicate volume and normality of acid added as well as the quantity of inorganic carbon added).</li> <li>– Addition of strong acids and bases (indicate volume and normality).</li> <li>– Manipulation of the <math>\text{Ca}^{2+}</math> concentration (indicate the recipe of artificial seawater used).</li> </ul>
Type of manipulation	<ul style="list-style-type: none"> <li>– Once before the experiment.</li> <li>– Continuous control during the experiment.</li> </ul>
Parameters of the carbonate chemistry	<ul style="list-style-type: none"> <li>– Values at the beginning and end of the experiment. If available, values during the experiment should also be provided.</li> <li>– At least two parameters of the carbonate system should be reported together with temperature and salinity.</li> <li>– The pH scale must be indicated.</li> </ul>
History of organisms investigated	<ul style="list-style-type: none"> <li>– Describe the conditions under which the organisms were maintained prior to the experiment. Were they pre-acclimated? If so, indicate the environmental conditions and the duration of the pre-acclimation phase.</li> </ul>

## 2.6 Recommendations for standards and guidelines

Several factors can collectively affect the success of CO<sub>2</sub> manipulation experiments. Here we make recommendations regarding the method of seawater CO<sub>2</sub> manipulation; the choice of which can be critical in obtaining significant and reproducible results in CO<sub>2</sub> perturbation experiments.

The method of manipulating carbonate chemistry in seawater is of utmost importance. Bubbling seawater with CO<sub>2</sub> enriched air may be the first choice because it is a very efficient way to manipulate seawater carbonate chemistry and, more importantly, it exactly mimics carbonate chemistry changes occurring in the years to come; the future scenario for ocean carbon chemistry being an increase in p(CO<sub>2</sub>) and DIC (decrease in pH) without alteration of A<sub>T</sub>. However, seawater aeration by bubbling may lead to difficulties in phytoplankton cultures (Shi *et al.*, 2009). Bubbling must therefore be sufficiently gentle to cause minimal impact on the phytoplankton assemblage or the cells should be separated from the bubbles by a gas-permeable membrane. Alternative but equally effective methods, when species are highly sensitive to bubbling, is to equilibrate the culture media with air at target p(CO<sub>2</sub>) or to mix it with high-CO<sub>2</sub> seawater prior to cell inoculation. Although the later method has yet to be widely tested, it also exactly mimics changes in carbonate chemistry in the future ocean just as the method of bubbling with high-CO<sub>2</sub> gases. The third method, equally reliable, is the combined addition of acid and bicarbonate and/or carbonate (increase in p(CO<sub>2</sub>) and DIC, but decrease in pH and A<sub>T</sub>) and then addition of Na<sub>2</sub>CO<sub>3</sub> and/or NaHCO<sub>3</sub> (to restore A<sub>T</sub>). This method also yields the conditions predicted to occur in the future ocean. Other methods (manipulation of  $\Omega_{Ar}$  and Ca<sup>2+</sup>) can be useful in the context of specific process studies (such as calcification).

## 2.7 References

- Agegian C. R., 1985. *The biogeochemical ecology of Porolithon gardineri (Foslie)*. Ph.D. thesis, University of Hawaii, 178 p.
- Ben-Yaakov S. & Goldhaber M. B., 1973. The influence of sea water composition on the apparent constants of the carbonate system. *Deep-Sea Research* 20:87-99.
- Brewer P. G. & Goldman J. C., 1976. Alkalinity changes generated by phytoplankton growth. *Limnology and Oceanography* 21:108-117.
- Coplen T. B., Bohlke J. K., De Bièvre P., Ding T., Holden N. E., Hopple J. A., Krouse H. R., Lamberty A., Peiser H. S., Revesz K., Rieder S. E., Rosman K. J. R., Roth E., Taylor P. D. P., Vocke R. D. & Xiao Y. K., 2002. Isotope-abundance variations of selected elements (IUPAC Technical Report) *Pure Applied Chemistry* 74:1987-2017.
- Delille B., Harlay J., Zondervan I., Jacquet S., Chou L., Wollast R., Bellerby R. G. J., Frankignoulle M., Borges A. V., Riebesell U. & Gattuso J.-P., 2005. Response of primary production and calcification to changes of pCO<sub>2</sub> during experimental blooms of the coccolithophorid *Emiliana huxleyi*. *Global Biogeochemical Cycles* 19, GB2023. doi:10.129/2004GB002318.
- Dickson A. G., Sabine C. L. & Christian J. R., 2007. Guide to best practices for ocean CO<sub>2</sub> measurements. *PICES Special Publication* 3:1-191.
- DOE, 1994. Handbook of methods for the analysis of the various parameters of the carbon dioxide system in sea water. In: Dickson A. G. & Goyet C. (Eds.), Carbon Dioxide Information Analysis Center, Oak Ridge National Laboratory.
- Engel A., Delille B., Jacquet S., Riebesell U., Rochelle-Newall E., Terbrüggen A. & Zondervan I., 2004. Transparent exopolymer particles and dissolved organic carbon production by *Emiliana huxleyi* exposed to different CO<sub>2</sub> concentrations: a mesocosm experiment. *Aquatic Microbial Ecology* 34:93-104.
- Feng Y., Warner M. E., Zhang Y., Sun J., Fu F. X., Rose J. M. & Hutchins D. A., 2008. Interactive effects of increased pCO<sub>2</sub>, temperature and irradiance on the marine coccolithophore *Emiliana huxleyi* (Prymnesiophyceae). *European Journal of Phycology* 43:87-98.
- Gattuso J.-P., Frankignoulle M., Bourge I., Romaine S. & Buddemeier R. W., 1998. Effect of calcium carbonate saturation of seawater on coral calcification. *Global and Planetary Change* 18:37-46.

- Gattuso J.-P., Reynaud-Vaganay S., Furla P., Romaine-Lioud S., Jaubert J., Bourge I. & Frankignoulle M., 2000. Calcification does not stimulate photosynthesis in the zooxanthellate scleractinian coral *Stylophora pistillata*. *Limnology and Oceanography* 45:246–250.
- Gattuso J.-P. & Lavigne H., 2009. Technical Note: Approaches and software tools to investigate the impact of ocean acidification. *Biogeosciences* 6:2121–2133.
- Grasshoff K., Kremling K. & Ehrhardt M. (Eds.), 1999. Methods of seawater analysis, 600 p. New York: Wiley.
- Guillard R. R. L. & Ryther J. H., 1962. Studies of marine planktonic diatoms. 1. *Cyclotella nana* Hustedt, and *Denotula confervacea* (Cleve) Gran. *Canadian Journal of Microbiology* 8:229–239.
- Iglesias-Rodriguez M. D., Buitenhuis E. T., Raven J. A., Schofield O., Poulton A. J., Gibbs S., Halloran P., R. & de Baar H. J. W., 2008b. Response to comment on “Phytoplankton calcification in a high-CO<sub>2</sub> world”. *Science* 322:1466c–1466c.
- Iglesias-Rodriguez M. D., Halloran P. R., Rickaby R. E. M., Hall I. R., Colmenero-Hidalgo E., Gittins J. R., Green D. R. H., Tyrrell T., Gibbs S. J., von Dassow P., Rehm E., Armbrust E. V. & Boessenkool K. P., 2008a. Phytoplankton calcification in a high-CO<sub>2</sub> world. *Science* 320:336–340.
- Kim H.-C. & Lee K., 2009. Significant contribution of dissolved organic matter to seawater alkalinity. *Geophysical Research Letters* 36, L20603. doi:10.1029/2009GL040271.
- Kim H.-C., Lee K. & Choi W., 2006. Contribution of phytoplankton and bacterial cells to the measured alkalinity of seawater. *Limnology and Oceanography* 51:331–338.
- Langdon C., Takahashi T., Marubini F., Atkinson M., Sweeney C., Aceves H., Barnett H., Chipman D. & Goddard J., 2000. Effect of calcium carbonate saturation state on the rate of calcification of an experimental coral reef. *Global Biogeochemical Cycles* 14:639–654.
- Lavigne H. & Gattuso J.-P., 2010. Seacarb: calculates parameters of the seawater carbonate system. R Package 2.3 (portions of code were contributed by J.-M. Epitalon, A. Hofmann, B. Gentili, J. Orr, A. Proye & K. Soetart). <http://cran.at.r-project.org/web/packages/seacarb/index.html>.
- Lueker T. J., Dickson A. G. & Keeling C. D., 2000. Ocean pCO<sub>2</sub> calculated from dissolved inorganic carbon, alkalinity, and equations for K<sub>1</sub> and K<sub>2</sub>: validation based on laboratory measurements of CO<sub>2</sub> in gas and seawater at equilibrium. *Marine Chemistry* 70:105–119.
- Nydal R. & Lövseth K., 1996. Carbon-14 measurements in atmospheric CO<sub>2</sub> from northern and southern hemisphere sites, 1962–1993. *Environmental Sciences Division Publication* 4582: Oak Ridge, Tennessee: Carbon Dioxide Information Analysis Center.
- Rost B., Zondervan I. & Wolf-Gladrow D., 2008. Sensitivity of phytoplankton to future changes in ocean carbonate chemistry: current knowledge, contradictions and research directions. *Marine Ecology Progress Series* 373:227–237.
- Schneider K. & Erez J., 2006. The effect of carbonate chemistry on calcification and photosynthesis in the hermatypic coral *Acropora eurystroma*. *Limnology and Oceanography* 51:1284–1293.
- Schulz K. G., Barcelos e Ramos J., Zeebe R. E. & Riebesell U., 2009. CO<sub>2</sub> perturbation experiments: similarities and differences between dissolved inorganic carbon and total alkalinity manipulations. *Biogeosciences* 6:2145–2153.
- Sciandra A., Harlay J., Lefèvre D., Lemée R., Rimmelin P., Denis M. & Gattuso J.-P., 2003. Response of coccolithophorid *Emiliana huxleyi* to elevated partial pressure of CO<sub>2</sub> under nitrogen limitation. *Marine Ecology Progress Series* 261:111–122.
- Shi D., Xu Y. & Morel F. M. M., 2009. Effects of the pH/pCO<sub>2</sub> control method on medium chemistry and phytoplankton growth. *Biogeosciences* 6:1199–1207.
- Trimborn S., Langer G. & Rost B., 2007. Effect of varying calcium concentrations and light intensities on calcification and photosynthesis in *Emiliana huxleyi*. *Limnology and Oceanography* 52:2285–2293.
- Wolf-Gladrow D. A., Zeebe R. E., Klaas C., Körtzinger A. & Dickson A. G., 2007. Total alkalinity: The explicit conservative expression and its application to biogeochemical processes. *Marine Chemistry* 106:287–300.
- Zeebe R. E. & Wolf-Gladrow D. A., 2001. *CO<sub>2</sub> in seawater: equilibrium, kinetics, isotopes* 346 p. Amsterdam: Elsevier.

### 3 Atmospheric CO<sub>2</sub> targets for ocean acidification perturbation experiments

James P. Barry<sup>1</sup>, Toby Tyrrell<sup>2</sup>, Lina Hansson<sup>3,4</sup>, Gian-Kasper Plattner<sup>5</sup> and Jean-Pierre Gattuso<sup>3,4</sup>

<sup>1</sup>Monterey Bay Aquarium Research Institute, USA

<sup>2</sup>National Oceanography Centre, University of Southampton, UK

<sup>3</sup>Laboratoire d'Océanographie, CNRS, France

<sup>4</sup>Observatoire Océanologique, Université Pierre et Marie Curie-Paris 6, France

<sup>5</sup>Climate and Environmental Physics, University of Bern, Switzerland

#### 3.1 Introduction

Research on ocean acidification has a primary goal of advancing our understanding of the consequences for marine organisms and ecosystems of future changes in ocean chemistry caused by the anthropogenic rise in atmospheric carbon dioxide levels. Though interesting as a basic research theme, ocean acidification science should play a key role in the development of national and international policies for reducing CO<sub>2</sub> emissions. To communicate the science of ocean acidification effectively to industrial leaders, the public and policy makers, the science community must present the results and research implications in clear and consistent terms that relate directly, if possible, to terms used currently in climate discussions, such as atmospheric CO<sub>2</sub> levels and potential stabilisation targets. To this end, ocean acidification research programmes should be considered, designed, and reported in the context of realistic ranges for atmospheric p(CO<sub>2</sub>) levels.

Throughout the brief history of ocean acidification research, a spectrum of p(CO<sub>2</sub>) levels has been used for CO<sub>2</sub> perturbation experiments. Though most studies involve the classic levels of ambient (~380 ppm) and future atmospheric p(CO<sub>2</sub>) (usually 750 ppm, corresponding to the p(CO<sub>2</sub>) level expected by 2100), values as low as 45 ppm (Buitenhuis *et al.*, 1999) and as high as 150,000 ppm (Kikkawa *et al.*, 2003) have been reported. As long as the scientific community continues to work at different levels of p(CO<sub>2</sub>), it will be difficult to integrate this information and develop coherent recommendations for policymakers concerning the impacts of fossil fuel emissions on the oceans. To promote direct comparability among studies and provide a clear link to atmospheric targets relevant to climate policy development, it is advantageous to select key values of atmospheric p(CO<sub>2</sub>) for use as primary targets in ocean acidification experiments. The range of these key values should overlap and span the range of present and future atmospheric levels. Although inclusion of a much broader range of atmospheric p(CO<sub>2</sub>) levels may be required for various reasons, the greatest societal benefit from ocean acidification studies is likely to lie in increasing our understanding of the functional responses of species, populations, and ecosystems to changes in ocean chemistry that could possibly occur over the next centuries.

Unlike atmospheric p(CO<sub>2</sub>), which is relatively homogeneous over the Earth, aqueous p(CO<sub>2</sub>) and other ocean carbonate system parameters can vary greatly over space and time (Figure 3.1; Table 3.1). Water temperature and salinity influence the solubility of carbon dioxide in seawater, widening the range of variability in the carbonate chemistry of the oceans, particularly with latitude (Figure 3.2). In deep waters, the accumulation of respiratory carbon dioxide increases the pools of total dissolved inorganic carbon (DIC<sup>1</sup>) and p(CO<sub>2</sub>), leading to lower pH, lower carbonate ion (CO<sub>3</sub><sup>2-</sup>) levels, and reduced saturation states for calcite (Ω<sub>c</sub>) and aragonite (Ω<sub>a</sub>). Consequently, pH typically decreases with depth over much of the world ocean, particularly in oxygen minimum zones. In the Eastern Pacific, low-pH waters from oxygen minimum zones upwell over the continental shelf (Feely *et al.*, 2008).

<sup>1</sup> Chapter 1 provides detailed information on the chemical terms and symbols used in the present chapter.

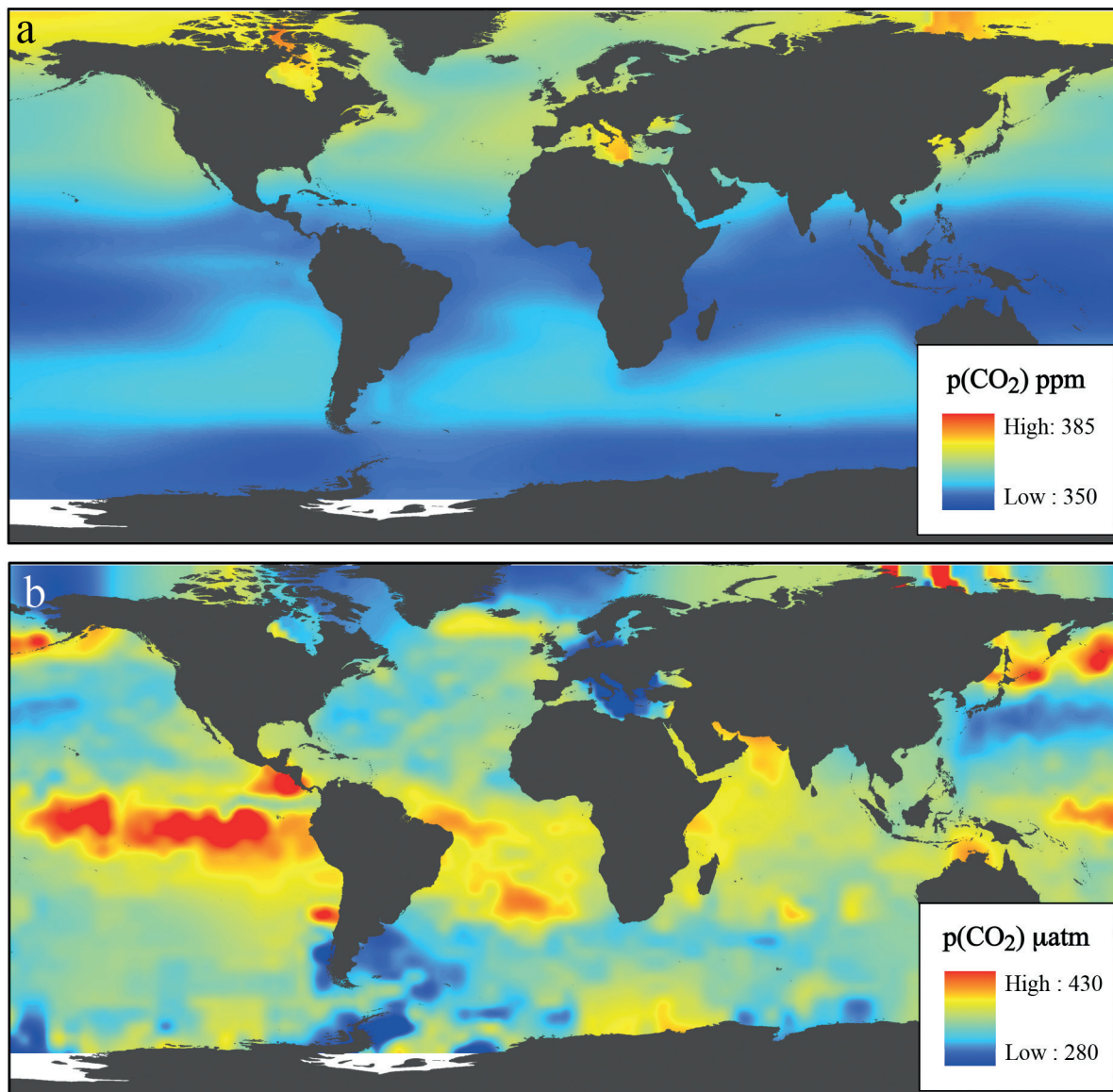

**Figure 3.1** Carbon dioxide concentrations over the ocean. A. Atmospheric  $p(\text{CO}_2)$  levels (ppm). B. Surface  $p(\text{CO}_2)$  ( $\mu\text{atm}$ ). Note the change in scale among plots. Data from Takahashi *et al.* (2009).

Temporal variation in carbonate system parameters can also be large, over scales as short as diel cycles (Bensoussan & Gattuso, 2007; Wootton *et al.*, 2008), over seasons (Kleypas *et al.*, 2006; Findlay *et al.*, 2008), and even in association with episodic ENSO events (Friederich *et al.*, 2002). As the balance between photosynthesis and respiration varies over diurnal, seasonal, or other periods, there is a corresponding variation in DIC, pH, and other ocean carbonate system parameters. DIC removal into phytoplankton blooms leads to an elevation of  $\text{pH}$ ,  $[\text{CO}_3^{2-}]$ ,  $\Omega_c$  and  $\Omega_a$  during late spring and summer. This is seen in model results and also in data from the Norwegian Sea and in the seas to the north and west of Iceland (Findlay *et al.*, 2008). Distinct, regular and repeated seasonal cycles are also seen at sites closer to the equator, for instance at BATS and HOT (Kleypas *et al.*, 2006). The use of a standard set of  $p(\text{CO}_2)_{\text{atm}}$  targets, converted to  $p(\text{CO}_2)_{\text{aq}}$  or other carbonate system parameters in the habitat of concern (e.g.  $\Omega_A$  in tropical surface waters or pH of temperate abyssal depths) will allow reporting of the relevant *in situ* carbonate system parameters while maintaining a link to the common currency and units of climate change policy.



Parameter	Mean (present-day)	Observed range (present-day)	Units	Notes
[DIC]	2017	1837 to 2204	$\mu\text{mol kg}^{-1}$	strong variation with latitude
[ $A_T$ ]	2305	2171 to 2458	$\mu\text{mol kg}^{-1}$	moderate spatial variability
[ $\text{CO}_3^{2-}$ ]	207	80 to 303	$\mu\text{mol kg}^{-1}$	strong variation with latitude
$\Omega_c$	5	1.9 to 9.2		strong variation with latitude
$\Omega_a$	3.3	1.2 to 5.4		strong variation with latitude
pH	8.10	7.91 to 8.46		strong spatial variability
p( $\text{CO}_2$ )	366	127 to 567	$\mu\text{atm}$	strong spatial variation
[ $\text{Ca}^{2+}$ ]	10600		$\mu\text{mol kg}^{-1}$	little spatial or seasonal variation
[ $\text{Mg}^{2+}$ ]	55000		$\mu\text{mol kg}^{-1}$	little spatial or seasonal variation
Temp.	18.7	-1.9 to 29.6	$^{\circ}\text{C}$	strong variation with latitude
Salinity	34.8	10.8 to 37.5	-	moderate spatial variation
[ $\text{PO}_4^{3-}$ ]	0.53	0.02 to 2.11	$\mu\text{mol kg}^{-1}$	strong variation with latitude
[ $\text{SiO}_2$ ]	7.35	0.37 to 101	$\mu\text{mol kg}^{-1}$	high in Southern Ocean

**Table 3.1** Mean and range of variation in the main ocean carbonate system parameters over open ocean surface waters of the world. This table can be used as a reference in the design of experiments including near present-day (1990's) carbonate system values (future conditions will obviously differ for some parameters). The ranges of total dissolved inorganic carbon (DIC) and total alkalinity ( $A_T$ ) are from the gridded GLODAP database (Key *et al.*, 2004) and represent surface water (0 and 10 m) of the open ocean, i.e. excluding coastal, shelf, and enclosed seas, near-shore, and estuarine environments. Other carbonate system parameters were calculated from DIC and  $A_T$  using the *seacarb* software (see main text); temperature (Stephens *et al.*, 2001) and salinity (Boyer *et al.*, 2001) were taken from the World Ocean Atlas (Antonov *et al.*, 2006; Garcia *et al.*, 2006; Locarnini *et al.*, 2006) database. The mean values are weighted averages according to the surface areas of the grid cells. Mean pH was calculated from mean  $[\text{H}^+]$ .

The goal of this chapter is to provide an overview of factors that influence the choice of atmospheric  $\text{CO}_2$  levels used in ocean acidification studies, based on experimental design, target environments, location, and analytical approach. The overriding philosophy for these guidelines is that ocean acidification research should attempt to provide predictive capabilities concerning the response of the oceans, including its physics, biochemistry, and biology, to a realistic range of future atmospheric p( $\text{CO}_2$ ) levels.

### 3.2 Approaches and methodologies

We investigate the issue of target levels of atmospheric p( $\text{CO}_2$ ), discuss the conversion of atmospheric values into equivalent parameters of ocean carbonate chemistry, and then provide recommendations depending on the number of treatment levels that can be manipulated.

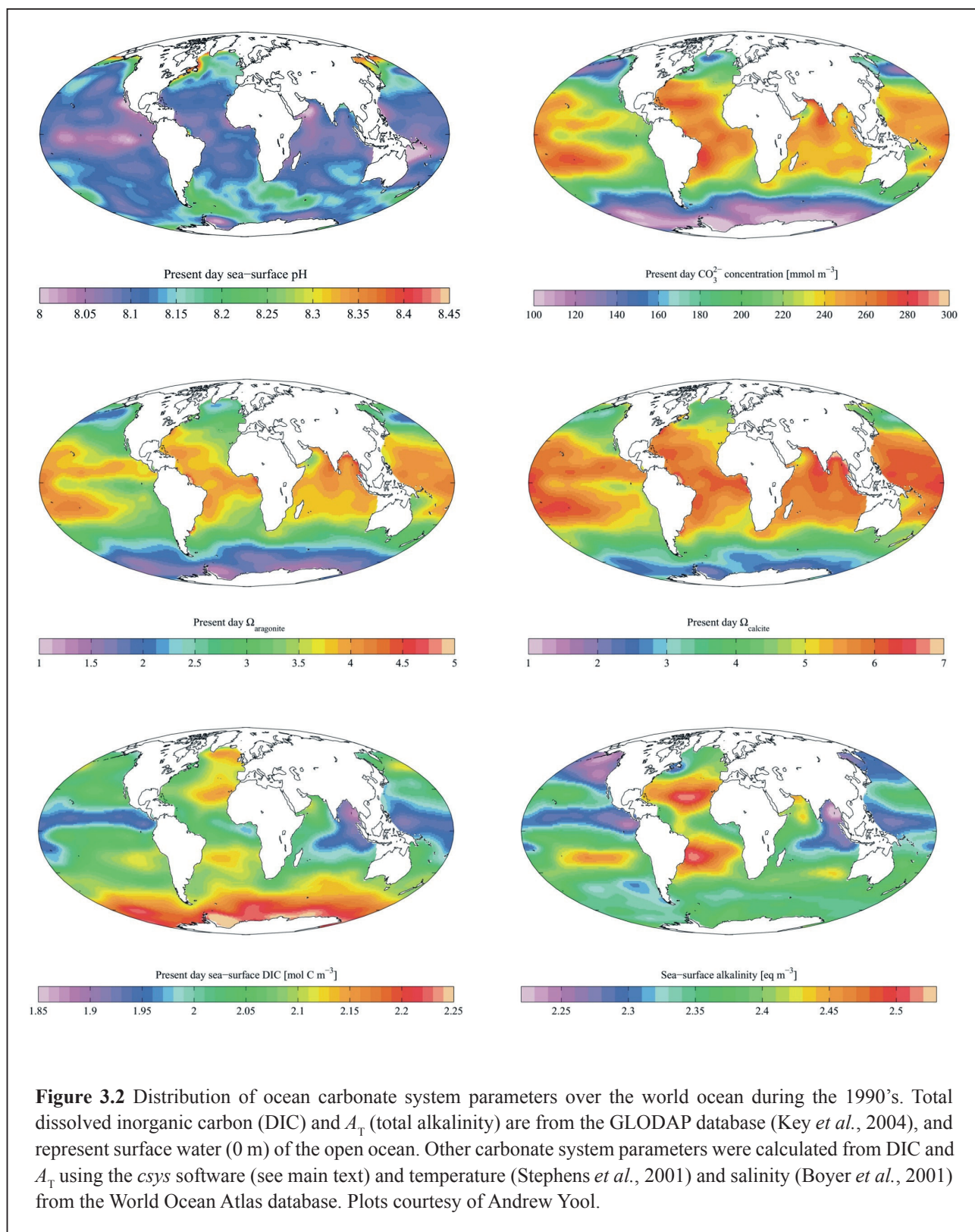

### 3.2.1 Selection of key $p(\text{CO}_2)_{\text{atm}}$ values

Key values for  $p(\text{CO}_2)_{\text{atm}}$  used in ocean acidification experiments should be based mainly on reasonable future trajectories of atmospheric  $p(\text{CO}_2)$ , including intermediate stabilisation targets. The Intergovernmental Panel on Climate Change (IPCC) in the Special Report on Emissions Scenarios (SRES; Nakićenović & Swart, 2000)

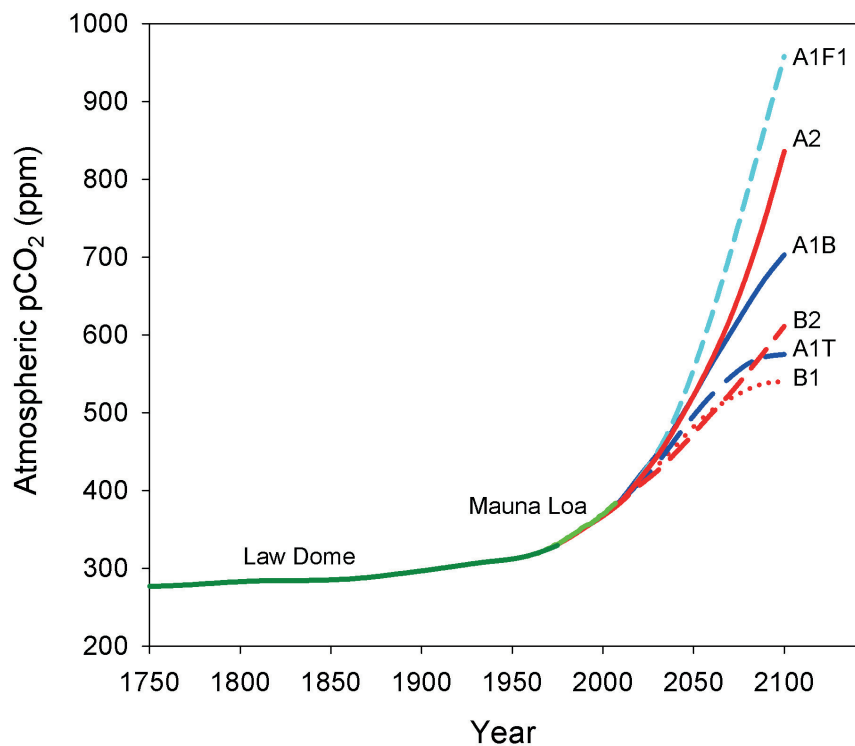

**Figure 3.3** Atmospheric  $p(\text{CO}_2)$  levels from Antarctic ice cores at the Law Dome (Etheridge *et al.*, 1998), instrumental observations at Mauna Loa (Keeling *et al.*, 2008), and  $p(\text{CO}_2)$  concentrations resulting from SRES climate scenarios using the Bern carbon cycle model (Nakićenović & Swart, 2000).

outlined scenarios projecting fossil fuel  $\text{CO}_2$  emissions through 2100, based on population and economic growth, rates of technology development, and societal attitudes. SRES scenarios indicate a continual rise in  $p(\text{CO}_2)_{\text{atm}}$  with levels at 2100 ranging between  $\sim 530$  to  $970$  ppm  $p(\text{CO}_2)_{\text{atm}}$  (Figure 3.3), depending on the scenario and carbon cycle model used. Recent models indicate that continued warming of the sea surface will inhibit ocean carbon uptake, leading to  $\sim 4\%$  higher atmospheric carbon dioxide levels in 2100 than expected by the SRES scenarios (Plattner *et al.*, 2001). Atmospheric  $\text{CO}_2$  trajectories beyond 2100 may exceed 1000 ppm, or could approach stabilisation targets from 450 to as high as 1000 ppm, roughly along WRE stabilisation pathways (Wigley *et al.*, 1996).

Environmental variability during the recent evolutionary history of marine ecosystems is also important to consider for ocean acidification studies, due to its role in shaping the physiological tolerances of marine organisms and maintaining genetic diversity within populations. Atmospheric  $\text{CO}_2$  has varied greatly over Earth history (Kasting, 1993), and generally decreased through the Phanerozoic from over 5000 ppm to relatively stable and low levels well below 1000 ppm through most of the Cenozoic (Berner, 1990). Through at least the latter half of the Quaternary ( $\sim 0.8$  My), atmospheric  $\text{CO}_2$  has generally oscillated rhythmically between glacial ( $\sim 180$  ppm) to interglacial ( $\sim 280$  ppm) extremes (Figure 3.4). This pendulum of  $p(\text{CO}_2)_{\text{atm}}$  has driven a parallel modulation of ocean pH, temperature, hypoxia, and other factors, that undoubtedly influenced the recent evolution of a many marine organism. Variation in ocean chemistry during this period is therefore an important context for considering the impacts of future climate scenarios. Although few experimental studies have included  $p(\text{CO}_2)_{\text{atm}}$  levels below ambient, Riebesell *et al.* (2000) included a “glacial” climate (190 ppm  $\text{CO}_2$ ) along with present-day (350 ppm) and future (750 ppm) levels in a mesocosm study concerning their effects on phytoplankton communities.

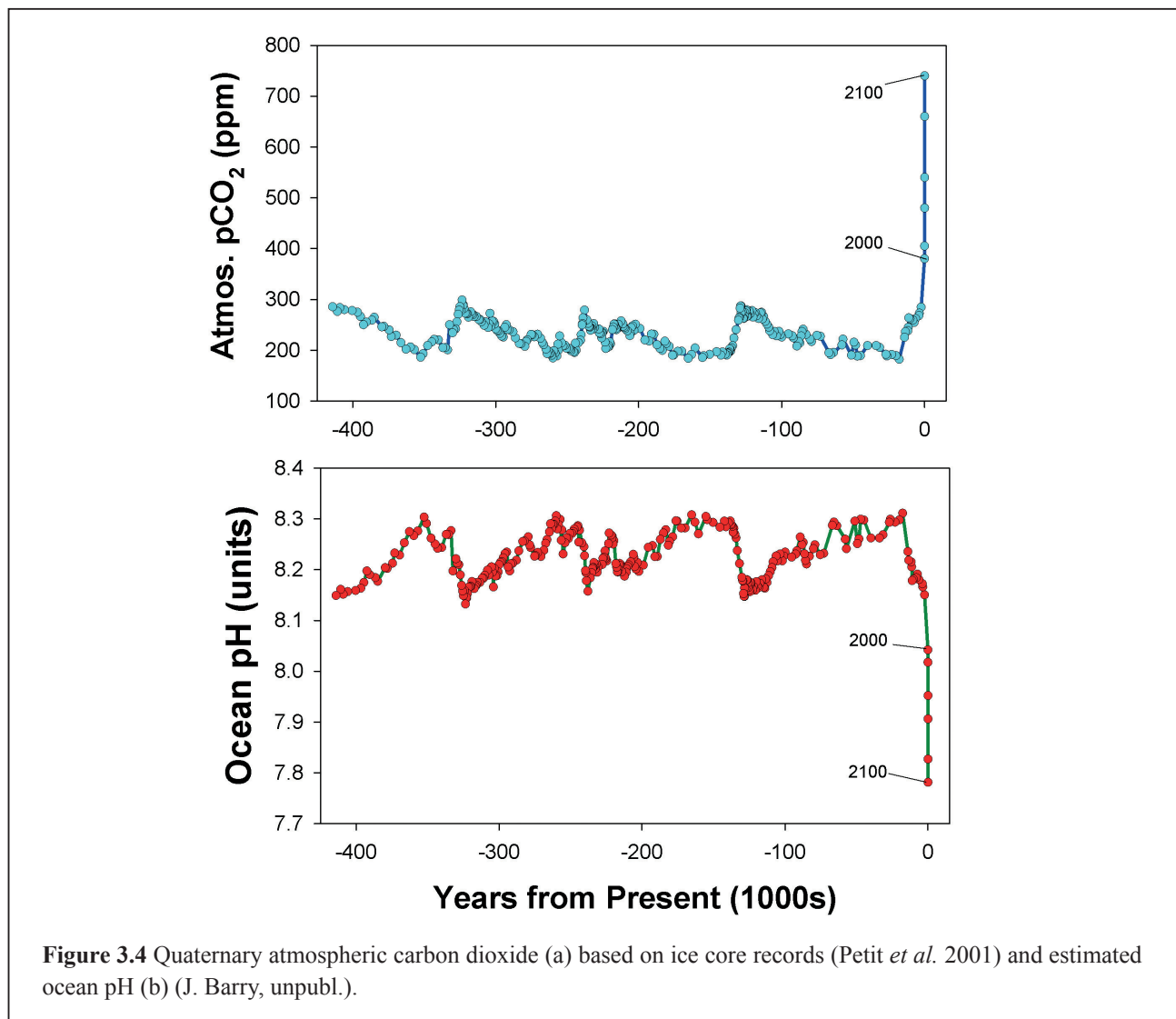

Levels of  $p(\text{CO}_2)_{\text{atm}}$  exceeding those expected under future climate scenarios may also be useful, for example in studies examining the physiological response of organisms to environmental hypercapnia. Variation in ocean  $p(\text{CO}_2)$ , pH and other key parameters can act directly on the physiological performance of organisms, with impacts on the growth, reproduction, behaviour and survival of individuals, which in turn affect the demographic rates (i.e. birth and death rates) of populations, interactions between species and, ultimately, the structure and function of ecosystems. While the objectives of an ocean acidification research project include characterisation of the performance of organisms over a realistic range of future  $p(\text{CO}_2)_{\text{atm}}$  levels, inclusion of considerably higher  $p(\text{CO}_2)$  treatments often help constrain their boundaries of performance (e.g. Kurihara & Shirayama, 2004). Knowledge of performance boundaries can also guide subsequent studies on similar taxa. This approach may be particularly important for studies where logistical constraints limit replication or variation among replicates reduces statistical power.

Key  $p(\text{CO}_2)_{\text{atm}}$  values could be organised according to arbitrary schemes, such as multiples of preindustrial atmospheric levels (PAL) or a range of near log-ratio values (Table 3.2). Multiples of PAL allow 3 or 4 treatment levels in the realm of realistic changes in  $p(\text{CO}_2)_{\text{atm}}$  over the next millennium, and relate more closely to the much larger changes in  $p(\text{CO}_2)_{\text{atm}}$  levels that have occurred through Earth history (e.g. Kasting, 1993). Other schemes, such as a  $\sim$ log-ratio method shown in Table 3.2 could span even larger ranges, but provide even fewer treatment levels within reasonable future climate conditions. The range of key values using the latter examples overlaps only marginally with the range of probable future  $p(\text{CO}_2)_{\text{atm}}$  levels, reducing their relevance for the general goals of ocean acidification research. Refer to chapter 4 for further information on statistics.

**Table 3.2** Alternative designs for key atmospheric  $p(\text{CO}_2)$  values used in ocean acidification studies.

- Realistic range of atmospheric  $p(\text{CO}_2)$  levels including glacial, preindustrial (280 ppm) and intermediate values to 2100 and beyond (1000 ppm; Wigley, 1996; Nakićenović & Swart 2000): 180, 280, 380, 450, 550, 650, 750, 1000
- Integer multiples of 280 ppm (pre-industrial value): 280, 560, 840, 1120, 1400, 1680, 1960, 2240, 2520, 2800, 4480, ...
- Range of  $\sim\log$ -ratio values to investigate the response to exposure to very high  $p(\text{CO}_2)_{\text{atm}}$  levels: 80, 1000, 3000, 10000, 30000, 100000, ...

### 3.2.2 Conversion of atmospheric $p(\text{CO}_2)$ levels to corresponding *in situ* ocean chemistry

Key atmospheric  $p(\text{CO}_2)$  values can be defined and used as guidelines, but their corresponding values for ocean carbonate system parameters are the primary measurements for ocean acidification experiments, and should also be reported. How can investigators convert key atmospheric  $p(\text{CO}_2)$  values to the *in situ*  $p(\text{CO}_2)$ , pH,  $\Omega_a$ ,  $\Omega_c$ , or other carbonate system parameters of interest for specific ocean acidification experiments? The simplest method may be to use published predictions of future ocean carbonate system values, based on changes in atmospheric  $p(\text{CO}_2)$  (Gattuso & Lavigne, 2009). Examples include predictions of future changes in ocean pH and carbonate saturation states (Gattuso *et al.*, 1999, Caldeira & Wickett, 2003, 2005; Guinotte *et al.*, 2003; Feely *et al.*, 2004; Orr *et al.*, 2005; Kleyvas *et al.*, 2006; Hoegh-Guldberg *et al.*, 2007). It is worth noting that the present-day latitudinal trends in some carbonate system variables will exist in the future, as seen for example in Figure 3.5 (Orret *et al.*, 2005). If all recoverable fossil fuels are eventually burnt, pH is expected to decline by about 0.8 units from the pre-industrial total, leading to an average surface pH decline from about 8.2 down to 7.4 (Caldeira & Wickett, 2003).

An alternate approach for predicting future ocean carbonate system values is to assume that surface water is in equilibrium with the atmosphere and use software such as *co2sys* (<http://cdiac.ornl.gov/oceans/co2rprt.html>), *seacarb* (<http://www.obs-vlfr.fr/~gattuso/seacarb.php><http://cran.at.r-project.org/web/packages/seacarb/>), or *csys* ([http://www.soest.hawaii.edu/oceanography/faculty/zeebe\\_files/CO2\\_System\\_in\\_Seawater/csys.html](http://www.soest.hawaii.edu/oceanography/faculty/zeebe_files/CO2_System_in_Seawater/csys.html)).

Each of these software packages can calculate a series of ocean carbonate parameters based on input for other carbonate system factors (see chapter 2 for examples of calculations using *seacarb*). Knowledge of 2 of 4 key carbonate parameters ( $p(\text{CO}_2)$ , pH, DIC,  $A_T$ ) and a few physical factors (temperature, salinity,  $[\text{SiO}_2]$ ,  $[\text{PO}_4^{3-}]$ , depth) is sufficient to calculate all other carbonate system values (see Dickson, this volume, for detailed information). This approach is particularly important for locations differing from the open ocean, such as coastal zones, inland seas, oxygen minimum zones, and deep-sea environments. Large divergence of the concentrations of calcium  $[\text{Ca}^{2+}]$  and/or magnesium  $[\text{Mg}^{2+}]$  from normal seawater values affects the calculation of calcite saturation state from  $[\text{CO}_3^{2-}]$  (Tyrrell & Zeebe, 2004). For some habitats and microenvironments,  $p(\text{CO}_2)_{\text{atm}}$  can be considerably higher than observed atmospheric levels.

Using carbonate chemistry software, investigators can substitute a future atmospheric carbon dioxide level (e.g. 750 ppm) for  $p(\text{CO}_2)$  in surface waters, then combine this with  $A_T$  to approximate future DIC,  $\Omega_a$ ,  $\Omega_c$ , or pH. Because  $p(\text{CO}_2)$  varies over the world ocean (Figure 3.1), a somewhat more accurate use of this method would use the  $p(\text{CO}_2)$  in surface waters at the location of interest, then increase it by an increment corresponding to the increase in  $p(\text{CO}_2)_{\text{atm}}$  of interest (e.g. +365 ppm: the difference between 750 and 385 ppm). Carbonate system parameters could then be calculated assuming no change in  $A_T$ . For deeper waters, the increase in DIC calculated for the surface could be added to observed deep-water DIC levels, and combined with *in situ*  $A_T$  to calculate other carbon system elements. For example, 30°C surface water with a total alkalinity of 2264  $\mu\text{mol kg}^{-1}$  equilibrated with a 380 ppm atmosphere, has a DIC concentration of  $\sim 1919 \mu\text{mol kg}^{-1}$  and an  $\Omega_a$  of 3.94, compared to a similar sample at 5°C, in which DIC is 2107  $\mu\text{mol kg}^{-1}$  and  $\Omega_a$  drops to only 1.74. Conversion

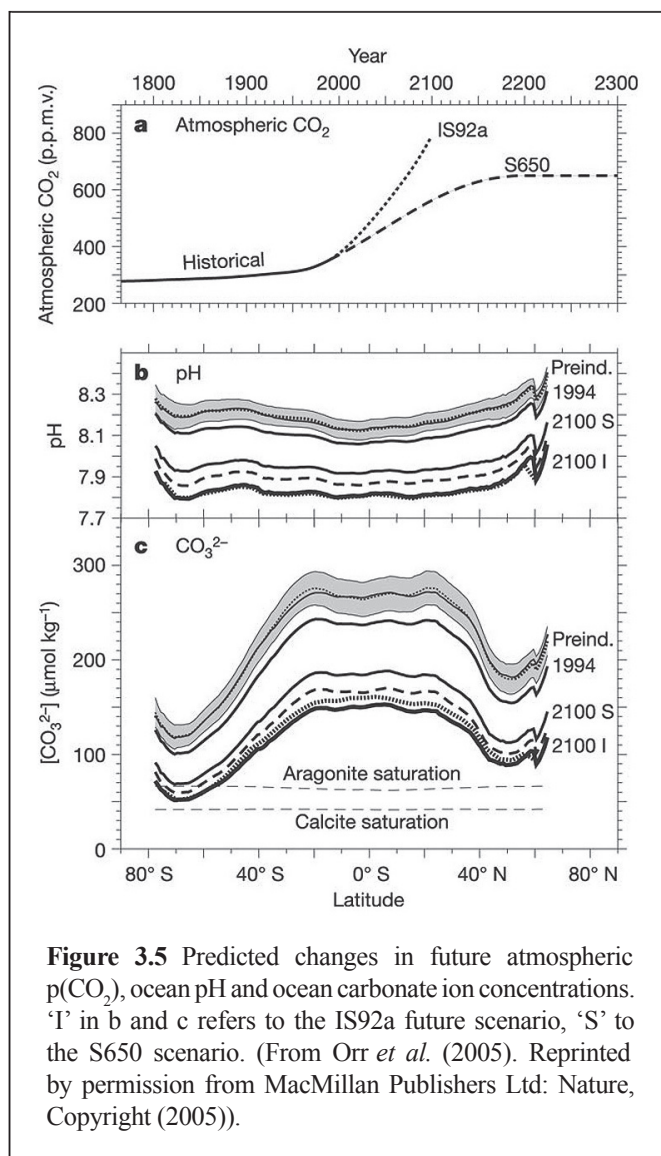

of atmospheric targets to deep-sea values can produce even larger changes. Due to low water temperatures and the accumulation of respiratory  $\text{CO}_2$  at depth,  $p(\text{CO}_2)_{\text{atm}}$  values of 380 and 750 ppm can be equivalent to bathyal  $p(\text{CO}_2)$  values of 1000 and  $>3000 \mu\text{atm}$ , respectively, particularly in oxygen minimum zones. Atmospheric  $p(\text{CO}_2)$  is typically reported for dry air, and should be adjusted for the vapour pressure of water (100% humidity) near the ocean surface (Zeebe & Wolf-Gladrow, 2001), leading to a decrease in  $p(\text{CO}_2)$  of about 3%.

Factors that will affect the predicted carbonate system parameters at key  $p(\text{CO}_2)_{\text{atm}}$  values include location, temperature, depth, productivity, regional to local oceanographic dynamics, the stability of the climate system and its recent history. The heterogeneous distribution of carbonate chemistry in the world ocean derives from the dynamic quasi-equilibrium that exists currently in the atmosphere-ocean system. As indicated before, even though  $p(\text{CO}_2)_{\text{atm}}$  is relatively homogenous over the globe,  $p(\text{CO}_2)$  in surface waters is highly heterogeneous (Figure 3.1). Estimating accurately the change in  $p(\text{CO}_2)$  at a particular location under an atmospheric level of 750 ppm  $\text{CO}_2$ , particularly in waters deep beneath the surface, is not straightforward. The predicted values, particularly for deep-sea waters that respond slowly to recent changes in atmospheric  $\text{CO}_2$ , depend upon the stability of the climate and the time scales for equilibration for the atmosphere-

ocean carbonate system. Failures of other assumptions, such as the long-term stability of total alkalinity (e.g. Ilyina *et al.*, 2009), ocean ventilation, carbonate rain ratios, etc. under continued climate change, also affect the accuracy of carbonate system predictions.

### 3.2.3 The number of treatments in ocean acidification experiments

The ideal perturbation experiment would measure the response of the experimental system (e.g. phytoplankton community dynamics, coral calcification or animal physiology) to a range of pH (or other carbonate system parameters) corresponding to a series of atmospheric  $p(\text{CO}_2)$  from 180 to 1000 ppm or higher. This would provide an understanding of the performance of organisms under glacial climate, present-day, and the near future, including the trend over a range in  $p(\text{CO}_2)_{\text{atm}}$  as well as inflection points in performance that could indicate tipping points.

In practice, however, logistical considerations limit the number of treatment levels and replication, thereby reducing the predictive resolution of the results. How many treatments levels are sufficient? What statistical design is optimal? At a minimum, 2 or 3 treatments levels analysed using an analysis of variance (ANOVA) design can yield valuable comparisons among locations or pH treatments (e.g. Manzello *et al.*, 2008). Analysis of variance is often used to compare differences among categorical variables, and may be the optimal design for studies limited to a few treatments. However, when the number of treatment levels can be increased, regression designs are typically more advantageous, particularly for continuous variables (e.g. ocean pH).

Since the parameters and processes measured are continuous variables, regression designs, particularly those with many treatment levels, allow interpretations of results that define functional relationships (e.g. variation in animal performance over a range of  $p(\text{CO}_2)$  levels), and may be more effective in identifying tipping points, if they exist. Although three treatments is a minimum for regression analyses, additional treatments, even at the expense of replication within treatments, often provides greater inferential power for a continuous variable. This approach may be particularly valuable in detecting potential tipping points. Regression may be less effective for systems where within-treatment responses are variable, and analysis of variance designs may increase statistical power. A more thorough discussion of experimental design is presented in chapter 4.

Where to start? At a minimum, perturbation experiments typically compare one or more treatments simulating future atmospheric  $\text{CO}_2$  levels to a baseline control treatment. A “preindustrial” climate near 280 ppm  $p(\text{CO}_2)_{\text{atm}}$  is the most suitable baseline treatment, since it represents a long-term (i.e. millennial) average concentration that has shaped animal performance and ecosystem function. Ambient or “present-day”  $p(\text{CO}_2)_{\text{atm}}$  (385 ppm  $\text{CO}_2$  = 2008 average on Mauna Loa; <http://cdiac.ornl.gov/ftp/trends/co2/maunaloa.co2>) has also been used as a baseline treatment in various studies, for comparing animal performance with future, higher  $p(\text{CO}_2)_{\text{atm}}$  levels. However, because the amount of anthropogenic carbon dioxide in the atmosphere has doubled nearly every 31 years (Hofmann *et al.*, 2008), “present-day” is a rapidly shifting target, and has already exceeded a  $p(\text{CO}_2)_{\text{atm}}$  threshold (350 ppm) proposed as a potential ecological tipping point (Hansen *et al.*, 2008).

Guidelines presented here (Table 3.3) are based on the number of treatment levels that can be supported both technically and financially. For studies limited to very few perturbed treatment levels, comparisons between “present-day” values (currently ~385 ppm), and 750 ppm (“future”) are recommended as primary treatment levels. While “preindustrial” (280 ppm)  $p(\text{CO}_2)_{\text{atm}}$  may be more relevant as a control treatment for many organisms than present-day  $p(\text{CO}_2)_{\text{atm}}$ , 280 ppm is technically difficult to achieve for most experiments, and “present-day” can be substituted as an unperturbed, control treatment. Ambient  $p(\text{CO}_2)_{\text{atm}}$  has value as a  $p(\text{CO}_2)_{\text{atm}}$  treatment because natural systems have acclimated to this level over decadal time scales, and because it provides a context for current changes in response variables. For a future treatment, 750 ppm is favoured after considering that ongoing efforts to curb fossil fuel  $\text{CO}_2$  emissions, recent emission records, and climate modelling based on (Nakčenočić & Swart, 2000; Plattner *et al.*, 2001) indicate  $p(\text{CO}_2)_{\text{atm}}$  will reach or exceed 750 ppm by 2100, a value midway between SRES scenario A1B and A2 (Figure 3.3). In addition, a 2-treatment comparison between these values is more likely to detect significant changes in performance than between smaller  $p(\text{CO}_2)_{\text{atm}}$  changes, particularly for field experiments where within-treatment variability can be high. Inclusion of “preindustrial”  $p(\text{CO}_2)_{\text{atm}}$  (280 ppm) conditions should be considered as a third treatment. Using this 2 or 3-treatment design, it should be possible to document changes to date (i.e. since ~1850), and project changes likely to occur by the end of this century.

As the number of treatment levels increases, the addition of stabilisation targets and important potential tipping points (e.g. 350 ppm: Hansen *et al.*, 2008; 450 ppm: Hoegh-Guldberg *et al.*, 2007, McNeil & Matear, 2008) for atmospheric  $\text{CO}_2$  can be added. Tipping points can be crucial for climate policy development and for increased awareness of society to the potentially non-linear response of Earth systems to climate change (Lenton *et al.*, 2008). Key values of atmospheric  $p(\text{CO}_2)$  recommended for ocean acidification studies (Table 3.3) can be used as guidelines for the design of experiments. These guidelines may require modification to fit particular needs, such as the addition of higher values to examine the boundaries of animal performance or to allow closer correspondence with crucial levels for specific carbonate system parameters (e.g.  $\Omega_a$  or  $\Omega_c \sim 1$ ). Increasing the number of treatments will provide greater predictive power, particularly for non-linear responses to ocean acidification.

Even if this chapter is devoted to a discussion on atmospheric  $\text{CO}_2$  targets, it is nevertheless important to note the potential synergy between multiple stressors. The effects of ocean acidification, thermal stress, and expanding hypoxia, all linked to anthropogenic climate change, act together to constrain the window of performance for marine organisms (Pörtner, 2008). Therefore, consideration of multiple climate stressors for ocean acidification experiments will elevate the value of these studies, allowing an integrated view of climate change impacts on ocean ecosystems.

**Table 3.3** Key  $p(\text{CO}_2)_{\text{atm}}$  values (ppm) for ocean acidification studies. These  $(\text{CO}_2)_{\text{atm}}$  levels are useful guidelines for perturbation experiments, and can be supplemented with other values of importance for specific studies, such as higher values for evaluating animal performance, or adjustments to correspond to key carbonate system values (e.g.  $\Omega_a$  or  $\Omega_c \sim 1$ ).

# of Treatments	Recommended $p(\text{CO}_2)_{\text{atm}}$ levels
2	present-day (~385), 750
3	280, present-day, 750
4	280, present-day, 550, 750
6	280, present-day, 550, 650, 750, 1000
8	180, 280, present-day, 450, 550, 650, 750, 1000
>8	Add values (e.g. 350, other) to increase resolution

### 3.3 Strengths and weaknesses

- Designing ocean acidification experiments in the context of realistic ranges in future atmospheric carbon dioxide levels will increase our understanding of the effects of impending environmental change and enable information-based policy development for climate adaptation.
- Use of key atmospheric carbon dioxide values as the principal treatment levels for ocean acidification experiments will provide a strong link between ocean acidification science and climate policy discussion.
- Comparison of results among ocean acidification studies will be easier by using common atmospheric  $\text{CO}_2$  targets, even though ocean carbonate chemistry parameters may differ.
- Regression designs with higher numbers of ocean acidification treatment levels are, in general, more likely to identify tipping points in organism or community performance than those with fewer treatment levels.

### 3.4 Potential pitfalls

- Conversion of key atmospheric  $p(\text{CO}_2)$  values to specific parameters of the ocean carbonate system can be complex.
- Characterisation of the effects of tipping points will be difficult, even if speculations about such values exist. Tipping points ( $p(\text{CO}_2)_{\text{atm}}$ ) likely differ from single organisms to whole ecosystems with complex direct and indirect consequences, time scales, and effects. On the other hand, some studies indicate a tipping point of 450 ppm for coral reefs, and if this point is not included, important results might be neglected.
- Using too narrow a scope of  $p(\text{CO}_2)_{\text{atm}}$  levels under conditions of high within-treatment variability may reduce the statistical power of analyses of variance.
- Physiological processes depend strongly on temperature and are often subject to a narrow thermal window (Pörtner *et al.*, 2004). This should not be neglected and multifactor experiments studying the interacting effects of  $p(\text{CO}_2)_{\text{atm}}$ , temperature, and perhaps oxygen should, if possible, be conducted. See chapter 9 of this Guide for more information.
- Logistical and other constraints limiting the number of  $p(\text{CO}_2)$  treatments can reduce inference concerning non-linear functional responses of organisms to ocean acidification.



### 3.5 Suggestions for improvements

Society and the field of ocean acidification science will benefit from the standardisation of atmospheric carbon dioxide levels as the common currency for discussion of perturbation studies. Use of atmospheric levels will promote the effective communication of results from ocean acidification studies to policymakers, and increase the impact of ocean acidification science in the development of climate adaptation policy. Within the oceanographic community the combined use of atmospheric  $p(\text{CO}_2)$  levels and related ocean carbonate chemistry parameters will help standardise comparisons of the potential effects of ocean acidification among habitats and ecosystems.

Increased focus on the characterisation of functional responses through the use of higher numbers of treatment levels will also increase the relevance of ocean acidification studies for society. Higher resolution among treatment levels will help characterise non-linear relationships between  $p(\text{CO}_2)_{\text{atm}}$  levels and ecosystem processes, and help evaluate ecosystem function near proposed tipping points.

### 3.6 Data reporting

The primary goal of data reporting for climate targets is to provide a template for comparing experimental results within the ocean science community, as well as between ocean and terrestrial systems. The common currency of atmospheric carbon dioxide levels and the use of standard or key  $p(\text{CO}_2)_{\text{atm}}$  values for most studies will elevate the value of ocean acidification science for society. Towards that goal, ocean acidification studies should report carefully the  $p(\text{CO}_2)_{\text{atm}}$  levels of interest for the study, with the corresponding levels of the various parameters of the carbonate system. Atmospheric carbon dioxide values should be used in the abstract, discussion, and conclusions of papers to maximise the likelihood that terms common within climate discussions are used clearly. Also required is a careful reporting of relevant ocean carbonate chemistry. While some values ( $p(\text{CO}_2)$ ) may be similar to target values, others (e.g. carbonate saturation, bicarbonate levels, etc.) may not. Considering the growing concern for the combined impacts of warming, acidification, and environmental hypoxia, it is advisable to report these and other potentially relevant environmental parameters.

### 3.7 Recommendations for standards and guidelines

1. Ocean acidification experiments should be based primarily on a broad range of realistic  $p(\text{CO}_2)_{\text{atm}}$  values spanning glacial, present-day, and the future (1000+ ppm).
2. Atmospheric  $p(\text{CO}_2)$  values of 180, 280, 350, “present-day”, 450, 550, 650, 750, and 1000 are guidelines for designing ocean acidification experiments.
3. For logistically limited studies, primary targets of 280, present-day (currently 385), and 750 ppm should be used.
4. Values of  $p(\text{CO}_2)_{\text{atm}}$  exceeding realistic ranges can be useful to examine the boundaries of animal performance, but should be followed by or coupled with realistic values.
5. Key atmospheric carbon dioxide levels should be converted to corresponding values of *in situ* ocean carbonate parameters for specific ocean acidification experiments.
6. Key  $p(\text{CO}_2)_{\text{atm}}$  and *in situ* carbonate system variables should be reported in tandem in publications reporting the results of ocean acidification experiments.
7. An increased number of treatments, even with reduced replication, may have greater power to characterise the functional relationship between ocean acidification parameters and organism or ecosystem performance.
8. Use of increased treatment levels increases the likelihood of detecting “tipping points” in organism or community performance.

### 3.8 References

- Antonov J. I., Locarnini R. A., Boyer T. P., Mishonov A. V. & Garcia H. E., 2006. World Ocean Atlas 2005. Volume 2: Salinity. In: Levitus S. (Ed.), *NOAA Atlas NESDIS 62*, pp. 1-182. Washington, D.C.: U.S. Government Printing Office.
- Bensoussan N. & Gattuso J.-P., 2007. Community primary production and calcification in a NW Mediterranean ecosystem dominated by calcareous macroalgae. *Marine Ecology Progress Series* 334:37-45.
- Berner R. A., 1990. Atmospheric carbon dioxide levels over Phanerozoic time. *Science* 249:1382-1386.
- Boyer T. P., Stephens C., Antonov J. I., Conkright M. E., Locarnini R. A., O'Brien T. D. & Garcia H. E., 2002. World Ocean Atlas 2001, Volume 2: Salinity. In: Levitus S. (Ed.), *NOAA Atlas NESDIS 50*, pp. 1-165. Washington D.C.: U.S. Government Printing Office.
- Buitenhuis E. T., de Baar H. J. W. & Veldhuis M. J. W., 1999. Photosynthesis and calcification by *Emiliania huxleyi* (Prymnesiophyceae) as a function of inorganic carbon species *Journal of Phycology* 35:949-959.
- Caldeira K. & Wickett M., 2003. Anthropogenic carbon and ocean pH. *Nature* 425:365.
- Caldeira K. & Wickett M. E., 2005. Ocean model predictions of chemistry changes from carbon dioxide emissions to the atmosphere and ocean. *Journal of Geophysical Research- Oceans* 110, C09S04. doi:10.1029/2004JC002671.
- Etheridge D. M., Steele L. P., Langenfelds R. L., Francey R. J., Barnola J.-M., & Morgan V. I., 1998. Historical CO<sub>2</sub> records from the Law Dome DE08, DE08-2, and DSS ice cores. In *Trends: A compendium of data on global change*. Oak Ridge, Tenn., U.S.A.: U.S. Department of Energy.
- Feely R. A., Sabine C. L., Hernandez-Ayon J. M., Ianson D. & Hales B., 2008. Evidence for upwelling of corrosive "acidified" water onto the continental shelf. *Science* 320:1490-1492.
- Feely R. A., Sabine C. L., Lee K., Berelson W., Kleypas J., Fabry V. J. & Millero F. J., 2004. Impact of anthropogenic CO<sub>2</sub> on the CaCO<sub>3</sub> system in the oceans. *Science* 305:362-366.
- Findlay H. S., Tyrrell T., Bellerby R. G. J., Merico A. & Skjelvan I., 2008. Carbon and nutrient mixed layer dynamics in the Norwegian Sea. *Biogeosciences* 5:1395-1410.
- Friederich G. E., Walz P. M., Burczynski M. G. & Chavez F. P., 2002. Inorganic carbon in the central California upwelling system during the 1997-1999 El Niño-La Niña event. *Progress in Oceanography* 54:185-203.
- Garcia H. E., Locarnini R. A., Boyer T. P. & Antonov J. I., 2006. World Ocean Atlas 2005. Volume 4: Nutrients (phosphate, nitrate, silicate). In: Levitus S. (Ed.), *NOAA Atlas NESDIS 64*, pp. 1-396. Washington, D.C.: U.S. Government Printing Office.
- Gattuso J.-P., Allemand D. & Frankignoulle M., 1999. Photosynthesis and calcification at cellular, organismal and community levels in coral reefs: a review on interactions and control by carbonate chemistry. *American Zoologist* 39:160-183.
- Gattuso J.-P. & Lavigne H., 2009. Technical Note: Approaches and software tools to investigate the impact of ocean acidification. *Biogeosciences* 6:2121-2133.
- Guinotte J. M., Buddemeier R. W. & Kleypas J. A., 2003. Future coral reef habitat marginality: temporal and spatial effects of climate change in the Pacific basin. *Coral Reefs* 22:551-558.
- Hansen J., Sato M., Kharecha P., Beerling D., Berner R., Masson-Delmotte V., Pagani M., Raymo M., Royer D. L. & Zachos J. C., 2008. Target atmospheric CO<sub>2</sub>: Where should humanity aim? *The Open Atmospheric Science Journal* 2:217-231.
- Hoegh-Guldberg O., Mumby P. J., Hooten A. J., Steneck R. S., Greenfield P., Gomez E., Harvell C. D., Sale P. F., Edwards A. J., Caldeira K., Knowlton N., Eakin C. M., Iglesias-Prieto R., Muthiga N., Bradbury R. H., Dubi A. & Hatziolos M. E., 2007. Coral reefs under rapid climate change and ocean acidification. *Science* 318:1737-1742.
- Hofmann D. J., Butler J. H. & Tans P. P., 2008. A new look at atmospheric carbon dioxide. *Atmospheric Environment* 43:2084-2086.
- Ilyina T., Zeebe R. E., Maier-Reimer E. & Heinze C., 2009. Early detection of ocean acidification effects on marine calcification. *Global Biogeochemical Cycles* 23, GB1008. doi:10.1029/2008GB003278.

- Kasting J., 1993. Earth's early atmosphere. *Science* 259:920-926.
- Keeling R. F., Piper S. C., Bollenbacher A. F. & Walker J. S., 2008. Atmospheric CO<sub>2</sub> records from sites in the SIO air sampling network. In *Trends: A compendium of data on global change*. Oak Ridge, Tenn.: Oak Ridge National Laboratory, U.S. Department of Energy.
- Key R. M., Kozyr A., Sabine C. L., Lee K., Wanninkhof R., Bullister J. L., Feely R. A., Millero F. J., Mordy C. & Peng T. H., 2004. A global ocean carbon climatology: results from Global Data Analysis Project (GLODAP). *Global Biogeochemical Cycles* 18, GB4031. doi:10.1029/2004GB002247.
- Kikkawa T., Ishimatsu A. & Kita J., 2003. Acute CO<sub>2</sub> tolerance during the early developmental stages of four marine teleosts. *Environmental Toxicology* 18:375-382.
- Kleypas J. A., Feely R. A., Fabry V. J., Langdon C., Sabine C. L. & Robbins L. L., 2006. *Impacts of ocean acidification on coral reefs and other marine calcifiers: a guide for future research*. 88 p. Boulder, Colorado: Institute for the Study of Society and Environment (ISSE) of the University Corporation for Atmospheric Research (UCAR).
- Kurihara H. & Shirayama Y., 2004. Effects of increased atmospheric CO<sub>2</sub> on sea urchin early development. *Marine Ecology Progress Series* 274:161-169.
- Lenton T. M., Held H., Kriegler E., Hall J. W., Lucht W., Rahmstorf S. & Schellnhuber H. J., 2008. Tipping elements in the Earth's climate system. *Proceedings of the National Academy of Science U.S.A.* 105:1786-1793.
- Locarnini R. A., Mishonov A. V., Antonov J. I., Boyer T. P. & Garcia H. E., 2006. World Ocean Atlas 2005. Volume 1: Temperature. In: Levitus S. (Ed.), *NOAA Atlas NESDIS 61*, pp. 1-182. Washington, D.C.: U.S. Government Printing Office.
- Manzello D. P., Kleypas J. A., Budd D. A., Eakin C. M., Glynn P. W. & Langdon C., 2008. Poorly cemented coral reefs of the eastern tropical Pacific: Possible insights into reef development in a high-CO<sub>2</sub> world. *Proceedings of the National Academy of Science U.S.A.* 105:10450-10455.
- McNeil B. I. & Matear R., 2008. Southern Ocean acidification: a tipping point at 450-ppm atmospheric CO<sub>2</sub>. *Proceedings of the National Academy of Science U.S.A.* 105:18860-18864.
- Nakićenović N. & Swart R., 2000. Special report on emissions scenarios: a special report of Working Group III of the Intergovernmental Panel on Climate Change, 599 p. Cambridge: Cambridge University Press.
- Orr J. C., Fabry V. J., Aumont O., Bopp L., Doney S. C., Feely R. A., Gnanadesikan A., Gruber N., Ishida A., Joos F., Key R. M., Lindsay K., Maier-Reimer E., Matear R., Monfray P., Mouchet A., Najjar R. G., Plattner G. K., Rodgers K. B., Sabine C. L., Sarmiento J. L., Schlitzer R., Slater R. D., Totterdell I. J., Weirig M. F., Yamanaka Y. & Yool A., 2005. Anthropogenic ocean acidification over the twenty-first century and its impact on calcifying organisms. *Nature* 437:681-686.
- Petit J. R., Jouzel J., Raynaud D., Barkov N. I., Barnola J.-M., Basile I., Bender M., Chappellaz J., Davis J., Delaygue G., Delmotte M., Kotlyakov V. M., Legrand M., Lipenkov V., Lorius C., Pépin L., Ritz C., Saltzman E. & Stievenard M., 2001. Vostok ice core data for 420,000 years. *IGBP PAGES/World Data Center for Paleoclimatology Data Contribution Series #2001-076*: Boulder, CO: NOAA/NGDC Paleoclimatology Program.
- Plattner G. K., Joos F., Stocker T. F. & Marchal O., 2001. Feedback mechanisms and sensitivities of ocean carbon uptake under global warming. *Tellus B* 53:564-592.
- Pörtner H.-O., 2008. Ecosystem effects of ocean acidification in times of ocean warming: a physiologist's view. *Marine Ecology Progress Series* 373:203-217.
- Pörtner H.-O., Langenbuch M. & Reipschläger A., 2004. Biological impact of elevated ocean CO<sub>2</sub> concentrations: Lessons from animal physiology and earth history. *Journal of Oceanography* 60:705-718.
- Riebesell U., Zondervan I., Rost B., Tortell P. D. & Morel F. M. M., 2000. Reduced calcification of marine plankton in response to increased atmospheric CO<sub>2</sub>. *Nature* 407:364-367.
- Stephens, C., J. I. Antonov, T. P. Boyer, M. E. Conkright, R. A. Locarnini, T. D. O'Brien, H. E. Garcia, 2002. World Ocean Atlas 2001, Volume 1: Temperature. In: Levitus S. (Ed.), *NOAA Atlas NESDIS 49*, pp. 1-167. Washington D.C.: U.S. Government Printing Office.

- Takahashi T., Sutherland S. C., Wanninkhof R., Sweeney C., Feely R. A., Chipman D. W., Hales B., Friederich G., Chavez F., Sabine C., Watson A., Bakker D. C. E., Schuster U., Metzl N., Inoue H. Y., Ishii M., Midorikawa T., Nojiri Y., Körtzinger A., Steinhoff T., Hoppema M., Olafsson J., Arnarson T. S., Tilbrook B., Johannessen T., Olsen A., Bellerby R., Wong C. S., Delille B., Bates N. R. & de Baar H. J. W., 2009. Climatological mean and decadal change in surface ocean pCO<sub>2</sub>, and net sea-air CO<sub>2</sub> flux over the global oceans. *Deep-Sea Research II* 56:554-577.
- Tyrrell T. & Zeebe R. E., 2004. History of carbonate ion concentration over the last 100 million years. *Geochimica et Cosmochimica Acta* 68:3521-3530.
- Wigley T. M. L., Richels R. & Edmonds J. A., 1996. Economic and environmental choices in the stabilization of atmospheric CO<sub>2</sub> concentrations. *Nature* 379:240-243.
- Wootton J. T., Pfister C. A. & Forester J. D., 2008. Dynamic patterns and ecological impacts of declining ocean pH in a high-resolution multi-year dataset. *Proceedings of the National Academy of Science U.S.A.* 105:18848-18853.
- Zeebe R. E. & Wolf-Gladrow D. A., 2001. *CO<sub>2</sub> in seawater: equilibrium, kinetics, isotopes*. 346 p. Amsterdam: Elsevier.

### 4 Designing ocean acidification experiments to maximise inference

Jon Havenhand<sup>1</sup>, Sam Dupont<sup>2</sup> and Gerry P. Quinn<sup>3</sup>

<sup>1</sup>Department of Marine Ecology - Tjärnö, University of Gothenburg, Sweden

<sup>2</sup>Department of Marine Ecology - Kristineberg, University of Gothenburg, Sweden

<sup>3</sup>School of Life & Environmental Sciences, Deakin University, Australia

#### 4.1 Introduction

Ocean acidification is a rapidly developing field. Researchers, ecosystem managers and policymakers alike are in urgent need of “good quality information” from which they can predict likely future changes and develop strategies to minimise impacts (e.g. identify those ecosystems that are most at risk, identify potential ocean acidification resistant strains or populations of key species, and suggest strategies for conservation efforts). So how do we ensure that our observations and experiments provide us with this “good quality information”?

Using appropriate experimental design and analysis methods is essential. We need to design our experiments and observations so that we maximise inference - i.e. maximise the potential to draw valid, unambiguous and informative conclusions. This requires that our experimental, or sampling, designs answer the questions we intend to ask. This in turn requires that we understand and apply the principles of good experimental design and analysis. If we fail to do so, we risk misinterpreting and misrepresenting the systems we are trying to understand.

Much of the research on the biological effects of ocean acidification is still in an exploratory phase, and there is much that can be learned from relatively simple approaches such as sampling programs to investigate variability and patterns in natural systems or simple, well-designed, experiments that investigate the effects of ocean acidification on different processes, species and/or locations. Collectively these could provide an accumulating body of valuable information that documents the effects of ocean acidification. These approaches can rapidly provide us with basic information from which we can build the background that is taken for granted in most research areas but which is lacking in ocean acidification research. Nonetheless, ocean acidification is a complex process and more sophisticated, often multi-factorial, experiments will be critically important for making progress in understanding ocean acidification. Experiments in mesocosms or in the field typically have greater environmental relevance and provide answers to research questions that simply are not tractable through laboratory experimentation. To date these experiments are the exception rather than the rule in ocean acidification research.

Whatever sampling or experimental design we use, it is critical that it is linked to an appropriate statistical modelling technique that allows us to estimate key parameters and test hypotheses of interest. Designing experiments well and analysing them appropriately is no more difficult than doing these badly, yet the record shows that ocean acidification researchers have not always done this and some (though certainly not all) published results may be more difficult to interpret than one might expect.

The aim of this chapter is to provide some basic guidelines for good experimental design and appropriate statistical analysis techniques. Our purpose is not to recapitulate well-established principles (see section 4.5 “Recommended texts for further reading”). Rather, we review here some key elements of experimental design and analysis relevant to ocean acidification research, using examples from the literature to highlight potential pitfalls and recommend best practice.

#### 4.2 The sampling universe

When we design experiments and collect and analyse data, we make a number of assumptions, some explicit, some implicit, and sometimes without even thinking about them. One of the most important of these concerns

## Part 2: Experimental design of perturbation experiments

interpreting our results: we assume that the findings from our sampling or experimental program apply to the real world (indeed this is often, though not always, the motivation for our experiments). The extent to which we can justifiably apply our results is determined by the spatial and temporal extent of the world from which we took our initial sampling or experimental units (usually organisms, samples of sediment/water, mesocosms etc.). This is the “sampling universe”. Because it is usually not possible to measure all units in the sampling universe (the population), we randomly draw representatives from that population (our sample). In fact, these samples are commonly drawn “haphazardly” rather than randomly, which has a strict statistical definition; see Quinn & Keough (2002) for more detail. In a formal sense, we can only extend the findings from our experiments to the sampling universe from which we took our sample.

A wealth of ecological and physiological literature tells us that individuals or observations taken from different locations, habitats or ecosystems, or from the same locations at different states of the tide, times of day, or seasons, would probably give us different answers to the same experiment. The likelihood that this is true increases as the size of our sample decreases, yet this constraint is often overlooked when interpreting results. Studies with constrained sampling universes are nonetheless valuable, not least because collectively many such studies can provide a comprehensive picture. Application of meta-analysis techniques (e.g. Gurevitch *et al.*, 2001; Moore *et al.*, 2004) to such data provides a very powerful tool to investigate the broader impacts of ocean acidification. It is therefore of utmost importance to report correctly information about the sampling universe in any publication<sup>1</sup>.

Awareness of the representativeness of our sample and the extent of our sampling universe allows us to clarify an important boundary between justifiable statistical inference and any broader speculation that we may wish to make when discussing our results. It is important to note that there is nothing wrong with this speculation – indeed it is an important part of hypothesis generation and the scientific method – however we must be very careful to identify it as such so that we, and others, do not misinterpret the significance (statistical and otherwise) of our results and incorrectly draw conclusions of broad, even global, significance from experiments that have used a highly restricted sample from a narrow sampling universe.

One of the most interesting examples of this problem comes from ocean acidification work on coccolithophorids. Several laboratory studies have assessed the impacts of ocean acidification on the coccolithophore *Emiliania huxleyi*, and have revealed apparent contradictions and paradoxes (Table 4.1). To an extent this can be ascribed to different approaches and measures (Ridgwell *et al.*, 2009), however most of these studies used single clones, each of which was isolated from a different field location up to 20 years earlier and subsequently raised in laboratory culture. The results of these studies provide valuable insights to the physiological responses of these different clones to ocean acidification, however the sampling universe of each study has been reduced to *one* specific genotype: clearly not representative of the “species” as a whole. Interestingly, recent work suggests that “*E. huxleyi*” should be regarded as a diverse assemblage of genotypes with variable calcification characteristics and ecological adaptations (Ridgwell *et al.*, 2009). Clearly, more work is required in this particular instance, however this highlights the problems of using one sample from one location to form the basis of our research.

Finally, at a more general scale, our sampling universe not only determines the spatio-temporal extent to which we can extrapolate our findings, but also the extent of variation among the different samples, or replicates in our experiments. The bigger the sampling universe, the greater the variance among sampling units and hence (all other things being equal) the less likely we are to be able to detect differences among our treatment groups (see section 4.4 below). This is a core problem in attempting to design environmentally relevant experiments and a trade-off has to be made between statistical power to detect a biologically important effect and how relevant our experiments are to the real world (Table 4.2).

---

<sup>1</sup> A literature survey of 26 haphazardly selected published articles that experimentally investigated the impacts of ocean acidification on marine invertebrates showed that only 10 gave sufficient information to identify the approximate sampling universe. Of these, only two had a sampling universe that spanned more than one geographic location.

Species	Strain (Clone)	Isolation date and location	Experimental design	Ambient light environment <sup>1</sup>	Carbonate chemistry manipulation	Calcification response <sup>2</sup>	Calcification response <sup>3</sup>
<i>Emiliana huxleyi</i>	NZEH (CAWPO6)	1992 South Pacific	laboratory culture	12:12 h L:D 150 $\mu\text{mol m}^{-2} \text{s}^{-1}$	CO <sub>2</sub> bubbling	↑	↑
<i>Emiliana huxleyi</i>	MBA 61/12/4	1991 North Atlantic	laboratory culture	12:12 h L:D 150 $\mu\text{mol m}^{-2} \text{s}^{-1}$	CO <sub>2</sub> bubbling	↑	↑
<i>Emiliana huxleyi</i>	PML B92/11A	1992 North Sea	laboratory culture	18:6 h L:D 150 $\mu\text{mol m}^{-2} \text{s}^{-1}$	acid/base	n/a	↓
<i>Emiliana huxleyi</i>	PML B92/11A	1992 North Sea	laboratory culture	24:0 h L:D 150 $\mu\text{mol m}^{-2} \text{s}^{-1}$	acid/base	n/a	↓
<i>Emiliana huxleyi</i>	CCMP 371	1987 Sargasso Sea	laboratory culture	12:12 h L:D 50 $\mu\text{mol m}^{-2} \text{s}^{-1}$	CO <sub>2</sub> bubbling	↔	n/a
<i>Emiliana huxleyi</i>	CCMP 371	1987 Sargasso Sea	laboratory culture	12:12 h L:D 400 $\mu\text{mol m}^{-2} \text{s}^{-1}$	CO <sub>2</sub> bubbling	↓	n/a
<i>Emiliana huxleyi</i>	TW1	2001 W Mediterranean	laboratory culture	24:0 h L:D 570 $\mu\text{mol m}^{-2} \text{s}^{-1}$	CO <sub>2</sub> bubbling	↓	↓
<i>Emiliana huxleyi</i>	88E	1988 Gulf of Maine	laboratory culture	24:0 h L:D 50 $\mu\text{mol m}^{-2} \text{s}^{-1}$	acid/base	n/a	↔ <sup>4</sup>
<i>Emiliana huxleyi</i>	Ch 24-90	1991 North Sea	laboratory culture	16:8 h L:D 300 $\mu\text{mol m}^{-2} \text{s}^{-1}$	CO <sub>2</sub> bubbling	n/a	↔ <sup>5</sup>
<i>Emiliana huxleyi</i>	NZEH (PLY M219)	1992 South Pacific	laboratory culture	24:0 h L:D 150 $\mu\text{mol m}^{-2} \text{s}^{-1}$	acid/base	↑	↑

**Table 4.1** Identities and origins of *Emiliana huxleyi* clones used in ocean acidification research. From Ridgwell *et al.* (2009).

### 4.3 Experimental design

Here we emphasise two aspects of experimental design. The first is minimising the risk of confounding, which is where the main factor of interest is confounded with (i.e. cannot be separated from) some other factor, often a “nuisance” variable such as spatial or temporal differences. The second is determining the appropriate sample size (number of replicate units) for any sampling or experimental program so that biologically important effects can be detected statistically.

Ecological scale	Small	↔	Large
Experimental subjects	genotypes/individuals	↔	communities/ecosystems
Environmental relevance	narrow	↔	broad
Statistical power	potentially high	↔	sometimes low
No. of parameters	few	↔	many
No. of replicates	many	↔	few
Measures / replicate	few	↔	many
Analysis type	univariate	↔	multivariate

**Table 4.2** Trade-offs of environmental relevance *versus* experimental power in ecological experiments.

### 4.3.1 Minimising confounding

There are three important principles of experimental design that minimise the risk of confounding:

- how replicate units are allocated to treatment groups;
- replication at a scale appropriate for the treatments;
- using realistic controls for experimental manipulations.

A related issue that is often confused with confounding, but which is separate, is the degree to which observations within and between treatment groups are independent of each other. There are several ways in which assumptions of independence (or non-independence) can be violated, introducing error to the analysis and potentially generating spurious results. While lack of independence can be incorporated into statistical models, this usually requires the nature of the correlations (non-independence) between observations to be specified. Doing this is not straightforward, and in the absence of prior knowledge of these correlation structures, designing experiments with independent observations is the safest bet.

Allocating replicates to treatments in a random manner is very important. Clustering all the replicates of one treatment in one area of the lab bench, one water bath or one end of the mesocosm pontoon increases the likelihood that uncontrolled environmental variables (sunlight, temperature, disturbances etc.) will differentially impact the treatments. This impact will then be (erroneously) attributed to the treatment group in subsequent analysis and thereby confounded with the effect of treatment. This problem can be avoided easily by allocating replicates to treatments randomly, with some pre-determined criteria for desired degree of interspersion.

When replicating at a scale appropriate for the treatments it is important to remember that multiple measures within the same experimental subunit (e.g. mesocosm) do not meet this requirement (here we shall use mesocosm as an example but the principles apply equally to culture containers, locations, individuals, sampling dates etc.). As we shall see, any treatment must be replicated at the level at which the treatment is applied. Sampling within mesocosms raises two separate issues: the first is that these multiple measures will almost certainly be non-independent; the second is that although there is replication, it is not at a scale relevant for the treatments.

With respect to the first of these issues, starting conditions vary naturally between individual mesocosms (indeed, incorporating this natural variation is often the whole point of mesocosm studies) and therefore measurements of a response variable *within* any given mesocosm will be more closely related to each other than to those *between* different mesocosms. Consequently, multiple measurements from within each mesocosm are non-independent. Nonetheless these measures are vital for understanding intra-mesocosm variation and obtaining reliable estimates of the average response of each mesocosm to the treatment manipulation.

Multiple measures within mesocosms cannot, however, tell us anything about variation within the treatment because the treatment is applied to a whole mesocosm. Being able to assess variation within treatments is important because this is the level at which we measure the response of our experimental system to the treatment manipulation. Therefore we need multiple independent measures, i.e. replicate mesocosms, at each of our chosen treatment levels. Not appreciating this distinction is a common problem, and some researchers obtain multiple replicate observations from within single mesocosms to test treatment effects, often with only one replicate mesocosm per treatment (e.g. Berge *et al.*, 2006; Engel *et al.*, 2005 [coccolith size data]; Spicer *et al.*, 2007). Such replication at a level *other* than that at which the treatments were applied has been termed “pseudoreplication” (Hurlbert, 1984). We choose to emphasise the term “confounding” (Quinn & Keough, 2002) because such designs *are* replicated, but not at the level of interest. We recognise the practical and funding constraints under which many ocean acidification researchers work. Nonetheless, in the case of the studies mentioned above, any effect of treatment (p(CO<sub>2</sub>) level) is potentially confounded with inherent differences between mesocosms and the resulting patterns cannot be attributed unequivocally to treatment. Consequently these results need to be interpreted cautiously.

While the principles of experimental design require replicate units (e.g. mesocosms), obtaining multiple replicate units at the appropriate spatial scale can sometimes be difficult or impossible. This is exemplified by



the CO<sub>2</sub> seep sites around Ischia, Italy (Hall-Spencer *et al.*, 2008). These authors quantified several measures of benthic community structure at locations within and outside areas of natural CO<sub>2</sub> seepage, at pHs of 8.14, 7.15, and 6.57 to 7.07 on both the North and South sides of the island (see chapter 8 of this guide, and Hall-Spencer *et al.* (2008) for details). Because a single site was sampled at each pH level/range on both N and S sides of the island this is effectively a “block design” in which different levels of the factor of interest (pH) are assessed in two replicate locations (N and S). The authors chose, however, to test for differences in measures of community composition (typically species abundances or percent cover) separately for the N and S sides of the island. Consequently there was no replication within treatment levels - i.e. the different pHs - and therefore the effect of pH was potentially confounded with differences between sites. It is difficult to conclude from this analysis that the observed differences in communities were only due to pH: they could simply reflect natural inter-site variation within the benthic communities around Ischia.

The fact that Hall-Spencer *et al.* (2008) found similar patterns on both N and S sides of the island (effectively two replicate “blocks” of site/pH combinations) argues against such confounding in this case, however this highlights a problem when there is only one CO<sub>2</sub> seep area. Replicate seep areas are rarely available. This presents a problem for the site of interest (the “impact” site), but it is almost always the case that replicate control sites (e.g. sites with no seeps) abound. In such cases, modified “Beyond BACI” designs and associated linear models (Underwood, 1997) allow formal statistical assessment of the hypothesis. These models compare the difference between the response at the impact site and the average response for the control sites with the variation in response between the multiple control sites. For cases where experimental manipulations are done on scales where replicates are extremely difficult or not available, long-term observations of natural fluctuations in the system prior to experimental manipulation can provide a sound logical basis for interpreting responses after imposing a new experimental treatment (e.g. Carpenter *et al.*, 1987). We are unaware of any ocean acidification experiments that have used this approach.

In comparison to the field, replication in the laboratory is usually much easier, however problems can nonetheless arise. Lack of replication sometimes occurs because of logistic constraints (e.g. the number of available mesocosms, tanks or constant temperature rooms restricts replication to one tank per treatment level). Although these constraints are understandable, the use of single replicates per treatment potentially generates confounding and should be avoided unless researchers can confidently argue that there are no other inherent differences between replicate units. Alternative approaches include repeating the experiment in time with different individuals, and (if relevant) alternating treatment levels between the different tanks (thus reducing any “tank effect”). This approach has been employed successfully by several groups (Gazeau *et al.*, 2007; Dupont *et al.*, 2008; Havenhand *et al.*, 2008). In other designs lack of replication occurs because notional “replicate” units (tanks, culture flasks, individuals) are held within the same container to which the treatment is applied (e.g. Michaelidis *et al.*, 2005). Solving this problem for ocean acidification experiments can become a logistical problem (and perhaps impossible) if taken to the extreme, however there are some sensible, and important, compromises that can be reached. For example, re-distribution of replicates among treatment combinations can reduce these problems. In a design with different levels of p(CO<sub>2</sub>) and temperature, single replicates of each level of p(CO<sub>2</sub>) could be nested within one replicate temperature treatment and this pattern repeated for replicate temperature treatments. This “split-plot” design is far more powerful than an (essentially) unreplicated design with one tank per treatment, but it is nonetheless a compromise solution that is not as powerful as applying the treatment combinations individually to each replicate.

The final principle, the importance of using appropriate controls for experimental manipulations, is very well known and requires little additional emphasis here other than to ensure this practice is followed.

#### 4.3.2 The importance of statistical power

A key issue in the design of any experiment is ensuring sufficient power to detect biologically meaningful differences caused by treatments. If we design experiments in this way then we usually also solve a second, and often overlooked, problem: that our experiments must also have sufficient power to conclude no biologically meaningful effect of our treatments where none exists. For ocean acidification research, where we are often

attempting to identify whether ocean acidification has, or does not have, a significant impact on a given process, this second issue can be vitally important. The unfortunately common practice of concluding that a non-significant statistical test means the treatment had no effect is both philosophically and statistically flawed: a non-significant result means that the results are inconclusive (see e.g. Nakagawa & Foster, 2004).

In most routine statistical testing, the probability that an experiment does not detect a biologically important effect when such an effect is actually present (a Type II error,  $\beta$ ) is uncontrolled and depends on sample size, variability between experimental units, the size of the actual treatment effect and the prescribed level of Type I error ( $\alpha$ , the significance level used to reject or not reject a null hypothesis, conventionally set to 0.05). Consequently, the statistical power of the test ( $1 - \beta$ ) is also usually unknown and variable, and the test of the null hypothesis may be weak. Importantly, we are often unaware of this.

This process can be addressed using “power analysis”. This allows us to calculate the power of a test as a function of sample size for a given level of variance (obtained from pilot experiments),  $\alpha$ , and the known, or expected, effect size. Several readily available and simple tools can calculate (for a given effect size,  $\alpha$ , and variance) the sample sizes required in order to reject the null hypothesis with a known level of statistical confidence (i.e. power; the example given in Figure 4.1 was calculated using G\*power<sup>2</sup>). This is a valuable technique that allows us to use preliminary data to optimise the power of our experiments, thereby maximising our research outcomes per unit of research resources. Power analysis of data from pilot experiments is strongly recommended before planning definitive experiments.

It is often recommended that interpretation of non-significant results be resolved using *post hoc* power analysis. This allows us to assess retrospectively the likelihood that our experiment *could* have detected a biologically important effect had it been present (see e.g. Havenhand & Schlegel, 2009). Several authors have recommended against this approach, however, because Type I and Type II error rates are non-independent, and the power of a non-significant test is always limited (see Nakagawa & Foster (2004) and references therein). For non-significant results, Nakagawa & Foster (2004) recommend alternative approaches for interpretation, but it is important to remember that we cannot ascribe a conclusion to lack of statistical significance: non-significant results are inconclusive.

### 4.4 Statistical analyses

#### 4.4.1 Estimating variance reliably

Most commonly used statistical tests require that we make assumptions about the distribution(s) of the data in our samples, and about patterns of residual (unexplained) variance. If our data do not meet these assumptions we run the risk of introducing error that can bias the test results and lead us to inappropriate conclusions. Consequently, it is accepted practice to check assumptions about distributions of data before proceeding to use statistical tests, and there are many standard methods in commercial statistics software for doing this. Many authors move straight to formal tests of assumptions (e.g. homoscedasticity, normality) without first visually inspecting the data, yet visual representations such as boxplots (Figure 4.2) can reveal important information about underlying patterns in the data. Moreover, boxplots provide a simple yet effective alternative to formal tests of the assumptions of the intended statistical tests (Quinn & Keough, 2002). This approach is strongly recommended.

If we follow a process common in the literature and choose to test formally the raw data shown in Figure 4.2 (rather than inspect the boxplots), we find that the variances in these subgroups are significantly different (i.e. heteroscedastic, Levene's test,  $F_{5,30} = 5.3, P = 0.001$ ) and therefore do not meet the assumptions of the ANOVA test that we might otherwise use to analyse these data. After transforming the data (using arc-sine transform) there is no significant heteroscedasticity, and the subsequent ANOVA shows a significant effect of Experiment and pH but no interaction between the two. This seems a perfectly satisfactory result, and indeed we have followed good analysis practice.

<sup>2</sup> see <http://www.psych.uni-duesseldorf.de/aap/projects/gpower/>

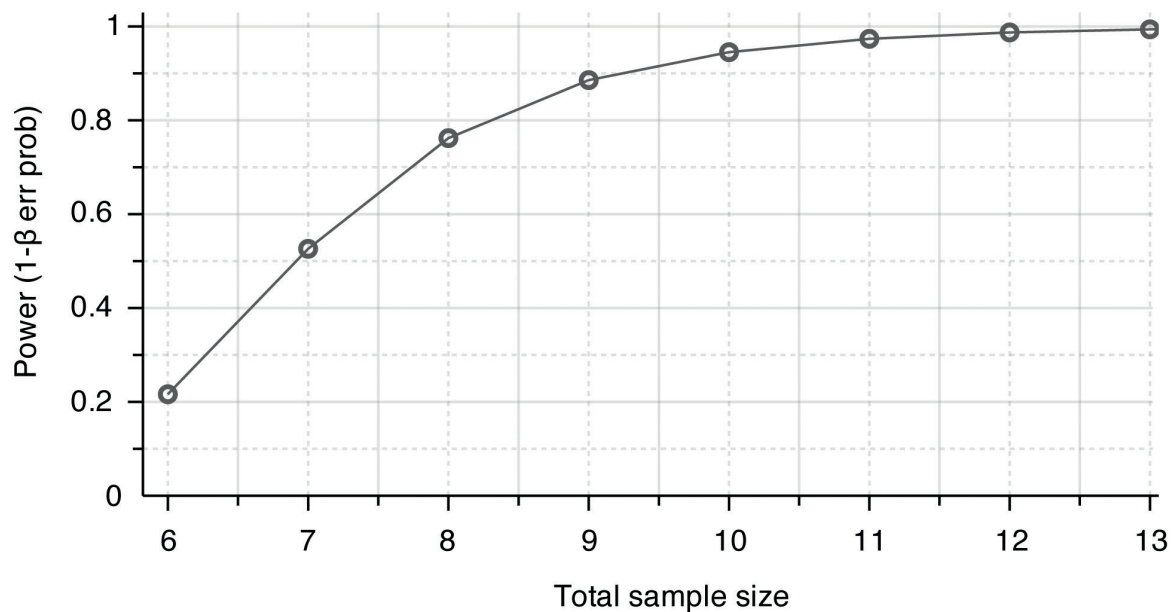

**Figure 4.1** Power as a function of sample size. Pilot data are for effects of 0.4 pH unit drop on sperm motility in the mussel *Mytilus edulis*. A sample size of >8 males would achieve adequate power ( $\geq 0.8$ ; conventionally accepted to be desirable, see Quinn & Keough (2002)). (Renborg & Havenhand, unpubl.).

As an alternative we could use boxplots to inspect the raw data visually (Figure 4.2) before moving to formal testing. Here too we can see that the data are indeed heteroscedastic (some subsets have far lower variance than others - see Quinn & Keough (2002) for guidelines on when to accept or reject assumptions of equal variance), and we would probably still choose to transform the data as before, check with a new boxplot, and then perhaps test using ANOVA in which we would of course obtain the same overall result as before. However the boxplots also show patterns that formal tests of heteroscedasticity do not reveal: the response in low pH treatments was far more variable than in high pH treatments (Figure 4.2). This finding may be at least as interesting biologically as the fact that the low pH treatments all have lower responses, yet we would have missed this if we had followed the first methodology. This highlights the value of visual inspection of data by (for example) boxplots as an important precursor to formal testing.

Once we have fitted a model (ANOVA for example), visual inspection of patterns of residuals (departures from fitted models) can be very informative for detecting problems with distributions, outliers and influential values in our statistical modelling. Again, these can often reveal unexpected patterns in our data that have significance for the process under study and/or our experimental protocols.

#### 4.4.2 Linear models – Analysis of Variance (ANOVA)

Linear models relate a single response (or dependent) variable to one or more predictor (independent) variables by estimating, and testing hypotheses about, model parameters (coefficients) for each predictor. As in the previous example, general linear models assume that response variables are normally distributed, with equal variances in the response for different levels of the predictor(s). By convention, linear models where the predictor(s) are categorical (grouping variables) are termed ANOVA models whereas those where the predictors are continuous are termed regression models. Statistically, however, these are both simply linear models and fitted in the same way using ordinary least squares (OLS). Models with both categorical and continuous predictors are also common. In contrast, generalised linear models allow distributions other than normal to be used, such as binomial and Poisson, and are based on Maximum Likelihood (ML) estimation, rather than OLS.

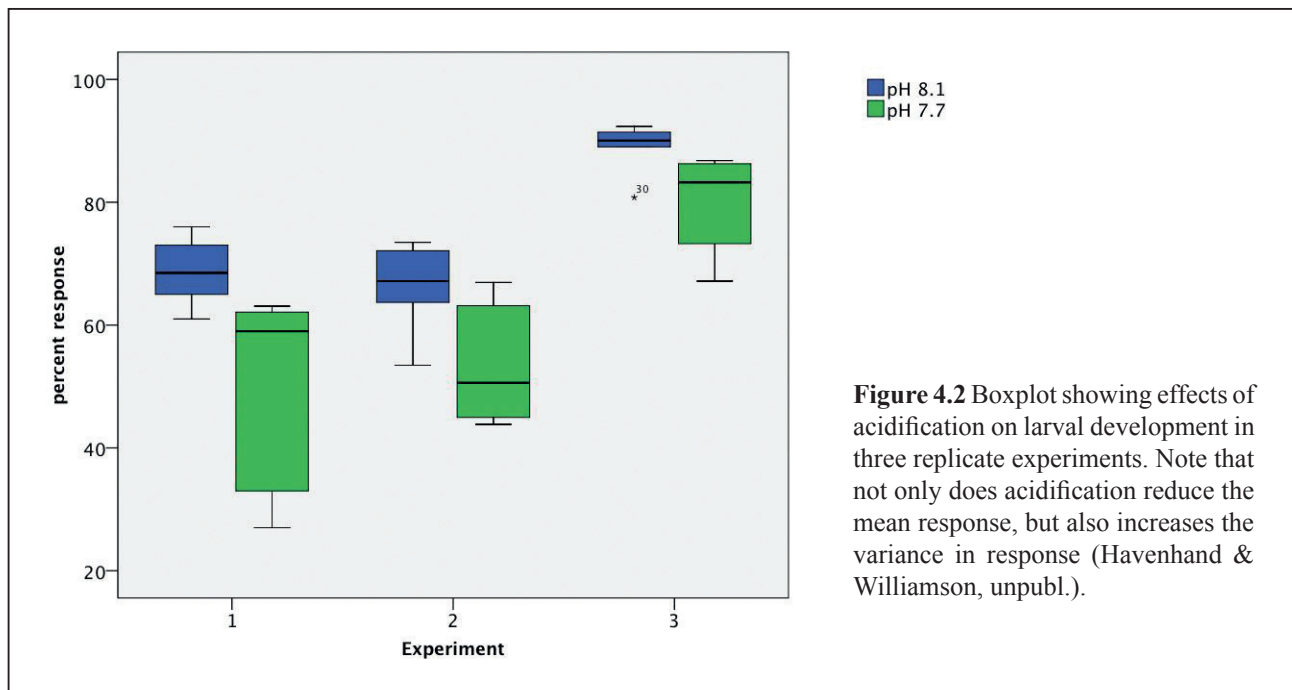

For ANOVA models, whether the predictor variable (often termed “factor”) is fixed or random can have an important influence on the form of the linear model, and on the form and power of the tests of our hypotheses. Many of the factors that we choose in our experiments (e.g. temperature,  $p(\text{CO}_2)$ , pH) are “fixed” because we determine these; i.e. we choose the levels of these factors, and we are generally not interested in extrapolating our findings to other levels of this factor. If we were to repeat the experiment we would probably choose the same levels of these factors. In a fully factorial ANOVA involving replicate independent observations of the effects of two fixed factors (say, temperature and pH) on a response variable, we determine the significance of the variance attributable to each factor, (and to the interaction between them), by comparing the variance for each of these with the variance for the residual (the only random term in the analysis). In practice this is done by generating variance ratios (“ $F$ -ratios”) using the mean-squares from the ANOVA (Table 4.3). This is a common analysis, with which most readers will be familiar.

In contrast, factors are “random” when we choose a random subset of all possible levels of the factor for analysis. Random factors might be different field sites, populations, or individuals and essentially represent a level of replication. We choose these factors because we wish to make inferences about all possible levels of this factor (e.g. all individuals within a population). If we were to repeat the experiment we would use different levels.

Often in biology, and especially in ocean acidification research, experiments use a mixture of fixed and random factors. In these “mixed models”, tests of the fixed factor use the interaction mean-square (rather than the residual) as the denominator (see Quinn & Keough (2002) for a detailed explanation of the logic of this analysis). As the interaction term always has fewer degrees of freedom than the residual, this usually results in a weaker test of the null hypothesis of interest. For example, changing one of the factors in the example in Table 4.3 from “fixed” to “random” reduces the significance of the  $F$ -ratio for the remaining fixed factor (pH) in the mixed model to a non-significant value (Table 4.4). Note that nothing else in this example has changed - only the nature (and name!) of one factor - however our conclusions as to the importance of pH on this (hypothetical) process would be different. Perhaps counter-intuitively, if we wish to increase the power of the test of the fixed factor (pH in Table 4.4) we must increase the number of levels of the random factor (e.g. more individuals). This is a key issue that should be taken into consideration when designing ocean acidification experiments using fixed and random factors.

**Table 4.3** Sample factorial ANOVA table for two fixed factors. Mean squares for all factors are tested over the  $MS_{\text{residual}}$ . The effect of pH is significant.

Factor	SS	df	MS	F calc	F	P
temp	200	3	66.7	$MS_{\text{temp}}/MS_{\text{res}}$	2	0.131
pH	300	3	100	$MS_{\text{pH}}/MS_{\text{res}}$	3	<b>0.043</b>
temp x pH	300	9	33.3	$MS_{\text{tempxpH}}/MS_{\text{res}}$	1	0.458
residual	1200	36	33.3			

#### 4.4.3 Repeated measures

In many of our experiments we want to know how a given response to a treatment changes over time, and whether this differs from the equivalent response in the controls. Consequently we take repeated measurements through time from the same experimental units (mesocosms, culture containers, individuals – again, here we will use mesocosms as an example). As outlined above, these repeated measures are non-independent: a measurement from any given mesocosm is more likely to be similar to a second measurement from the same mesocosm at a later date than to a second measurement from a different mesocosm. This principle also applies to time; repeated measures from the same mesocosm that are closer together in time are likely to be more correlated than measures further apart. This non-independence is fortunately not a problem because we can use a modelling approach that deals with these correlations, such as a traditional “repeated measures” ANOVA or the more general linear mixed models approach (West *et al.*, 2006). Methods for both these approaches are available in major statistical software packages. Again, it is important to remember that multiple (in this case repeated) measurements *within* each mesocosm are not true replicates of the treatment. Rather, the treatment should be replicated at the level of the mesocosm. Similarly, multiple measures within each mesocosm do not increase the power of the test of treatment effect, although they will give us a better idea of how an individual mesocosm responds over time to the treatments.

Although it is sometimes essential to know how a response changes over time, (effects of ocean acidification on developmental programs, for example) in other cases the change in response over time is less important (as in selection experiments). In such cases, making multiple repeated measurements can involve substantial investment in resources, and the benefits of having that extra temporal information need to be weighed against

**Table 4.4** Sample factorial “mixed-model” ANOVA table for one fixed factor (pH) and one random factor (individual). Mean square for the fixed factor (only) is now tested over the  $MS_{\text{interaction}}$ , with the result that the effect of pH is no longer significant, (note that the MS and F-values are identical to those in Table 4.3).

Factor	SS	df	MS	F calc	F	P
individual	200	3	66.7	$MS_{\text{indiv}}/MS_{\text{res}}$	2	0.131
pH	300	3	100	$MS_{\text{pH}}/MS_{\text{indivxpH}}$	3	0.088
indiv x pH	300	9	33.3	$MS_{\text{indivxpH}}/MS_{\text{res}}$	1	0.458
residual	1200	36	33.3			

the cost in resources of obtaining it: do we really need to measure responses over time, or will measures at the start and end of the experiment suffice? If the benefit:cost ratio is low, then resources might be better directed toward reducing the sampling frequency and increasing the number of replicates within each treatment level, thereby increasing the power of the experiment. These two do not always trade off directly and the issue will not always be this simple, however the principle is nonetheless important because our ability to detect any treatment effects depends on the number of replicates, not the number of repeat observations.

### 4.4.4 Do you know what you want? Planned vs. unplanned comparisons in ANOVA

When designing experiments we select treatments and treatment levels that are specifically relevant to our hypotheses. For example, in a simple one-way design to investigate the effects of  $p(\text{CO}_2)$  on growth of an organism we may have 5 different  $p(\text{CO}_2)$  levels, for each of which we have multiple replicate culture containers from which we sample at the end of the experiment. Assuming that the resulting data meet the relevant assumptions, we would analyse them with ANOVA to determine if there was a significant effect of treatment. If we find a significant effect, we often want to know where that effect lies, i.e. which  $p(\text{CO}_2)$  levels differed from which others. This is a routine question that can be answered using one of the many *post hoc* tests available in major statistical software packages (Tukey's test is a reliable and widely available method, and recommended here).

Philosophically, these *post hoc* tests are different to the initial ANOVA, which tests a global null-hypothesis of no difference between any treatment groups. In *post hoc* tests, however, we know there is a difference (the ANOVA has already shown us this) and the question is *where* is the difference. These tests address all possible pairwise comparisons to detect any and all differences among the treatment groups, and consequently tests like Tukey's control the overall probability of a Type I error, but reduce the significance level (and therefore the power) of each individual comparison. This is an excellent exploratory tool when all treatment groups are of equal interest.

In contrast to this procedure, "planned comparisons" are, as the name suggests, planned *a priori*. Here we are not interested in all possible contrasts among the different treatment groups, but rather in only a small number of these. For example, do responses at a high  $p(\text{CO}_2)$  level differ from each of the lower  $p(\text{CO}_2)$  levels? We do not know the outcome of the ANOVA when we plan these tests, (indeed the overall ANOVA result may be irrelevant to our interpretation of the data), and therefore our underlying philosophy for planned comparisons is the same as that for the ANOVA, namely testing specific null-hypotheses. Planned comparisons use the sums of squares from an ANOVA to test the specific contrasts that we are interested in, and are more powerful than their *post hoc* counterparts. It is important however that we restrict the number of comparisons we make - the individual contrasts should be independent of each other, and therefore they should represent only a few of all possible comparisons from among the treatment groups within the data set. Again, these tests are available in most major statistical software packages, and more details can be found in the texts listed in recommended reading. Although this approach has not yet (to our knowledge) been used in ocean acidification research, it is an extremely powerful method to assess specific hypotheses, and is recommended.

### 4.4.5 Linear models – regression analyses

In many experiments the total number of possible replicates is limited (this especially, although not uniquely, arises in larger-scale mesocosm and field studies). Under these circumstances, rather than trying to balance a small number of replicates against a number of categorical treatment levels, a viable alternative is to run each experimental unit at a different treatment level and analyse the results using a regression model.

This approach has several advantages:

- for smaller numbers of replicates it is a more powerful test than equivalent ANOVA-based designs (Cottingham *et al.*, 2005);
- it allows identification of the functional relationship between the treatment variable (e.g.  $p(\text{CO}_2)$ ) and the response variable (such relationships are extremely valuable for modellers);
- it allows prediction of responses at interpolated values of the treatment variable.

The most commonly used regression model (Model I or “y on x”) assumes that the independent or predictor variable (e.g.  $p(\text{CO}_2)$ ) has no error, i.e. is a “fixed” factor<sup>3</sup>. This is an important assumption if we wish to predict responses to different values of the independent variable, yet in practice the independent variable can often be subject to substantial error. Moreover, if we wish to describe the *relationship* between an independent and dependent variable (rather than predict the latter from the former) then a Model II (or “Geometric Mean”; “GM”) regression should be used. These Model II regressions always have steeper slopes than Model I regressions (the slope of the Model II regression is equal to that of the Model I regression divided by the correlation coefficient) and the difference between the two models increases as the relationship between the two variables becomes weaker (see Legendre & Legendre (1998) for more detail and examples).

An example of the value of regression-style analyses comes from the dynamics of many biological and developmental processes. Using single time-point observations of the effects of ocean acidification on rate processes (e.g. development, population growth) can give false impressions of reduced (vs. merely delayed) response if inappropriately interpreted (Figure 4.3; Dupont & Thorndyke, 2008). An alternative approach is to follow the whole process by making multiple observations over time and then analysing the data using regression models appropriate to the process (e.g. logistic growth). Note, however, that when using this approach the experimenter must be careful to ensure that measures over time are independent, or else incorporate the non-independence (correlations structure) into the model (see section 4.4.3).

The regression approach also has some drawbacks. Perhaps the greatest of these is that single values can have a strong influence on the relationship when the number of samples (points) is low. In such circumstances we must be especially vigilant to use one of the many available tools to investigate the influence of residuals. Secondly, the regression models most commonly used assume a straight-line response between the predictor (treatment) and response variable. Naturally this should always be checked by scatterplots and/or inspection of residuals. Curvilinear relationships can be modelled using non-linear models (e.g. Widdicombe *et al.*, 2009), or transformations may be used to linearise the data.

#### 4.4.6 Multivariate analyses

When we wish to fit models to multiple response variables, or simply wish to explore patterns in multi-variable datasets, then multivariate analyses are appropriate. These methods generally create a smaller subset of variables that each represent a combination of the original variables by maximising explained variance (e.g. multivariate analysis of variance [MANOVA] and the closely related discriminant function analysis and principal components analysis [PCA]) or calculate measures of dissimilarity between units based on the multiple variables (e.g. multidimensional scaling [MDS] and related hypothesis testing methods [e.g. ANOSIM, Permanova]).

At the time of publication very few ocean acidification studies report using multivariate analyses. This is surprising because multivariate techniques in general are ideally suited to studies where multiple response variables are measured in the same experimental units (e.g. Dupont *et al.*, 2008; Widdicombe *et al.* 2009). These analyses provide highly informative graphical displays and can test complex hypotheses about group differences (analogous to ANOVA) and relationships between variables (analogous to correlation/regression). Importantly, these techniques also avoid the inherent problems of increased Type I error rates that arise from multiple testing of separate variables from the same replicate units (e.g. Hall-Spencer *et al.*, 2008).

In one of the few available examples, Dupont *et al.* (2008) assessed the impact of ocean acidification on larval development of the brittlestar *Ophiothrix fragilis*, using several morphometric parameters. Each parameter was analysed individually by ANOVA and some differences were spotted, however by using a multivariate approach (Discriminant Function Analysis; Figure 4.4), larvae of different ages could be compared among treatments using all measured parameters. This led to the conclusion that low pH does not only induce a delay in development / reduced growth (see Figure 4.3 for differences in interpretation) but that larvae reared at pH 7.7 possessed proportions

<sup>3</sup> Model I regression is the standard regression model in almost all statistical and data management packages

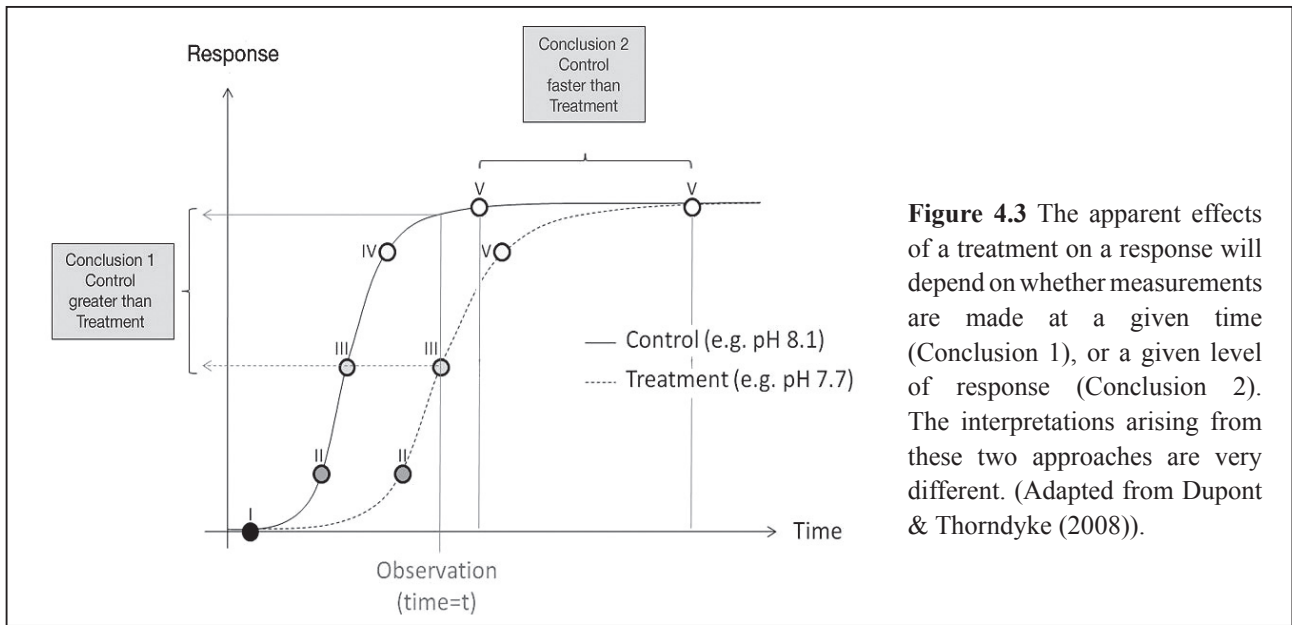

**Figure 4.3** The apparent effects of a treatment on a response will depend on whether measurements are made at a given time (Conclusion 1), or a given level of response (Conclusion 2). The interpretations arising from these two approaches are very different. (Adapted from Dupont & Thorndyke (2008)).

that were never observed in those reared at normal pH (8.1). This conclusion could not have been reached using univariate analyses such as ANOVA.

In a broader ecosystem context, community-level analyses using multivariate (multi-taxa) techniques such as MDS and PERMANOVA are relatively simple using commercially available software (notably PRIMER™, although some analyses are also possible in “R”) and we recommend this approach strongly for any studies attempting to understand emergent ecosystem-level responses to ocean acidification (see Widdicomb *et al.* (2009) for an example).

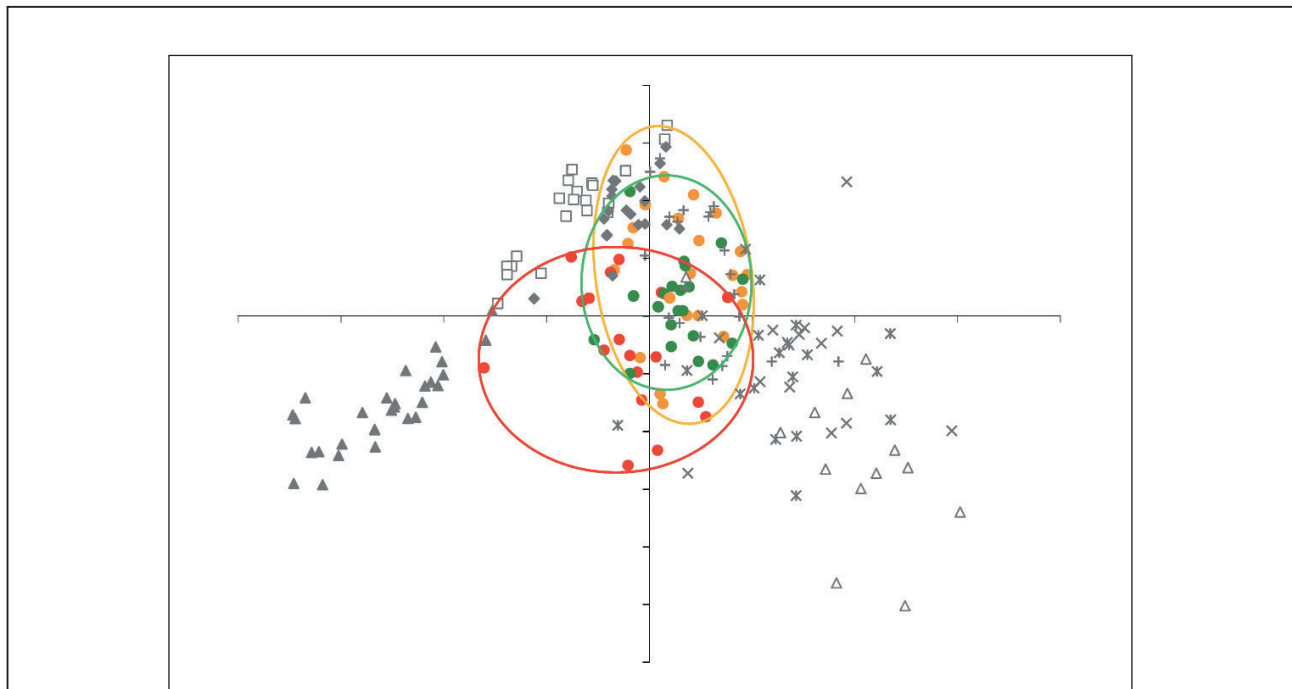

**Figure 4.4** *Ophiothrix fragilis*. Discriminant Function Analysis of morphometric parameters of larvae of different ages (d since fertilisation) and pH treatments. Coloured symbols correspond to larvae at day 3. Green is control (pH 8.1), yellow and red are low pH treatments (pH 7.9 and pH 7.7, respectively). Grey symbols correspond to the different days (from 1 to 8) in the control (from Dupont *et al.* (2008)).



#### 4.5 Recommended texts for further reading

This section has provided some basic guidelines. We strongly encourage the reader to delve a little deeper into at least one of the excellent texts available on this topic.

- Ford, E. D., 2000. *Scientific method for ecological research*. 564 p. Cambridge: Cambridge University Press.
- Quinn G. P. & Keough M. J., 2002. *Experimental design and data analysis for biologists*. 556 p. Cambridge: Cambridge University Press.
- Underwood A. J., 1997. *Experiments in ecology: their logical design and interpretation using analysis of variance*. 504 p. Cambridge: Cambridge University Press.

#### 4.6 Recommendations for standards and guidelines

##### 1. General principles

- a) Is the design of experiments relevant to the question we intend to answer?
- b) What is the limit of the “sampling universe”? Is it reported correctly in the publication? Do we over-generalise the spatial or temporal applicability of our results?

##### 2. Experimental design

- a) Before planning definitive experiments undertake pilot experiments and conduct power analyses to determine the required levels of replication in order to obtain adequate power.
- b) Minimise the risk of confounding by:
  - checking that observations from treatment groups are independent of each other;
  - check that treatments are replicated at appropriate spatial and temporal scales (avoid “pseudoreplication”);
  - allocate replicates to treatments randomly.
- c) Maximise the power to detect differences in response *between* treatment levels by increasing the number of replicates (experimental units to which the treatments are applied, e.g. mesocosms).

##### 3. Statistical analyses

- a) Whenever possible, perform power analysis on pilot data to ensure the experimental design has sufficient statistical power, before conducting the main experiment. [NB *post hoc* power analysis to interpret non-significant results is not recommended].
- b) Prior to formal statistical analysis, inspect patterns of variability in the raw data visually, using e.g. boxplots -- check assumptions about the distribution before proceeding to use statistical tests.
- c) For mixed ANOVA models, the power of the test of the fixed factor (e.g. pH, temperature) can only be improved by increasing the number of replicates of the random factor (e.g. individual).
- d) When possible, choose the more powerful hypothesis-driven planned comparison rather than their *post hoc* counterparts.
- e) Regression models may provide more powerful (and more broadly useful) tests -- especially when number of replicates is limited.
- f) Consider using statistically informative multivariate techniques to analyse experiments that measure multiple response variables from the same experimental units.

#### 4.7 References

- Berge J. A., Bjerkeng B., Pettersen O., Schaanning M. T. & Øxnevad S., 2006. Effects of increased sea water concentrations of CO<sub>2</sub> on growth of the bivalve *Mytilus edulis* L. *Chemosphere* 62:681-687.
- Carpenter S. R., Kitchell J. F., Hodgson J. R., Cochran P. A., Elser J. J., Elser M. M., Lodge D. M., Kretchmer D., He X. & Vonende C. N., 1987. Regulation of lake primary productivity by food web structure. *Ecology* 68:1863-1876.

- Cottingham K. L., Lennon J. T. & Brown B. L., 2005. Knowing when to draw the line: designing more informative ecological experiments. *Frontiers in Ecology and the Environment* 3:145-152.
- Dupont S., Havenhand J., Thorndyke W., Peck L. & Thorndyke M., 2008. Near-future level of CO<sub>2</sub>-driven ocean acidification radically affects larval survival and development in the brittlestar *Ophiothrix fragilis*. *Marine Ecology Progress Series* 373:285-294.
- Dupont S. & Thorndyke M. C., 2008. Ocean acidification and its impact on the early life-history stages of marine animals. In: Briand F. (Ed.), *Impacts of acidification on biological, chemical and physical systems in the Mediterranean and Black Seas*, pp. 89-97. Monaco: CIESM.
- Engel A., Zondervan I., Aerts K., Beaufort L., Benthien A., Chou L., Delille B., Gattuso J.-P., Harlay J., Heemann C., Hoffmann L., Jacquet S., Nejtgaard J., Pizay M.-D., Rochelle-Newall E., Schneider U., Terbreuggen A. & Riebesell U., 2005. Testing the direct effect of CO<sub>2</sub> concentration on a bloom the coccolithophorid *Emiliania huxleyi* in mesocosm experiments. *Limnology and Oceanography* 50:493-507.
- Gazeau F., Quiblier C., Jansen J. M., Gattuso J.-P., Middelburg J. J. & Heip C. H. R., 2007. Impact of elevated CO<sub>2</sub> on shellfish calcification. *Geophysical Research Letters* 34, L07603. doi:10.1029/2006GL028554.
- Gurevitch J., Curtis P. S. & Jones M. H., 2001. Meta-analysis in ecology. *Advances in Ecological Research* 32:199-247.
- Hall-Spencer J. M., Rodolfo-Metalpa R., Martin S., Ransome E., Fine M., Turner S. M., Rowley S. J., Tedesco D. & Buia M.-C., 2008. Volcanic carbon dioxide vents show ecosystem effects of ocean acidification. *Nature* 454:96-99.
- Havenhand J. N. & Schlegel P., 2009. Near-future levels of ocean acidification do not affect sperm motility and fertilization kinetics in the oyster *Crassostrea gigas*. *Biogeosciences* 6:3009-3015.
- Havenhand J. N., Buttler F.-R., Thorndyke M. C. & Williamson J. E., 2008. Near future levels of ocean acidification reduce fertilization success in a sea urchin. *Current Biology* 18:R651-R652.
- Hurlbert S. H., 1984. Pseudoreplication and the design of ecological field experiments. *Ecological Monographs* 54:187-211.
- Legendre P. & Legendre L., 1998. *Numerical ecology*. 870 p. Amsterdam: Elsevier.
- Michaelidis B., Ouzounis C., Palaras A. & Pörtner H.-O., 2005. Effects of long-term moderate hypercapnia on acid-base balance and growth rate in marine mussels *Mytilus galloprovincialis*. *Marine Ecology Progress Series* 293:109-118.
- Moore J. W., Ruesink J. L. & McDonald K. A., 2004. Impact of supply-side ecology on consumer-mediated coexistence: evidence from a meta-analysis. *American Naturalist* 163:480-487.
- Nakagawa S. & Foster T. M., 2004. The case against retrospective power analyses with an introduction to power analysis. *Acta Ethologica* 7:103-108.
- Quinn G. P. & Keough M. J., 2002. *Experimental design and data analysis for biologists* 556 p. Cambridge: Cambridge University Press.
- Ridgwell A., Schmidt D. N., Turley C., Brownlee C., Maldonado M. T., Tortell P. & Young J. R., 2009. From laboratory manipulations to earth system models: scaling calcification impacts of ocean acidification. *Biogeosciences* 6:2611-2623.
- Spicer J. I., Raffo A. & Widdicombe S., 2007. Influence of CO<sub>2</sub>-related seawater acidification on extracellular acid-base balance in the velvet swimming crab *Necora puber*. *Marine Biology* 151:1117-1125.
- Underwood A. J., 1997. *Experiments in ecology: their logical design and interpretation using analysis of variance*. 504 p. Cambridge: Cambridge University Press.
- West B., Welch K. B. & Galecki A. T., 2006. *Linear mixed models - a practical guide using statistical software* 376 p. Boca Raton: Chapman & Hall/CRC.
- Widdicombe S., Dashfield S. L., McNeill C. L., Needham H. R., Beesley A., McEvoy A., Øxnevad S., Clarke K. R. & Berge J. A., 2009. Effects of CO<sub>2</sub> induced seawater acidification on infaunal diversity and sediment nutrient fluxes. *Marine Ecology Progress Series* 379:59-75.

## 5 Bioassays, batch culture and chemostat experimentation

Julie LaRoche<sup>1</sup>, Björn Rost<sup>2</sup> and Anja Engel<sup>2</sup>

<sup>1</sup>Leibniz Institute of Marine Sciences (IFM-GEOMAR), Germany

<sup>2</sup>Alfred Wegener Institute for Polar and Marine Research, Germany

### 5.1 Introduction

This section describes some general guidelines and considerations to be observed when carrying out experiments that manipulate the CO<sub>2</sub> levels in laboratory cultures of microorganisms, especially for phytoplankton. The main premise for the establishment of these guidelines is that the experiments should represent the conditions of the future ocean as accurately as possible with respect to the carbonate system. Other manipulations mimicking for example the low CO<sub>2</sub> levels of glacial times or excessive CO<sub>2</sub> enrichments are also valid, for example to test for tipping points or to improve our understanding of certain processes. Regardless of whether one is working with mixed natural populations of microorganisms, or with monospecific cultures, there are two basic approaches that can be used to carry out manipulations of the carbonate system in small volume experiments: (1) batch and dilute batch cultures in the laboratory, alternatively called grow outs or bioassays in the field and (2) continuous cultures or chemostats and their variations such as turbidostats and cyclostats. A third alternative is to use semi-continuous cultures which are periodically diluted with fresh culture media in order to keep cells in the exponential growth phase. Batch, dilute batch and continuous cultures are best suited to answer different types of questions and have associated advantages and drawbacks that are discussed below. These types of approaches have been used for monospecific cultures in the laboratory and mixed microbial populations in the field (Hutchins *et al.*, 2003; Sciandra *et al.*, 2003; Cullen & Sherrell, 2005; Leonardos & Geider, 2005).

The acceptable methods for manipulating the carbonate chemistry have been described elsewhere in this guide to ocean acidification research (chapter 2) and are only briefly summarised here. The most representative ways to adjust the CO<sub>2</sub> levels so that they accurately reflect the conditions in the future ocean are (1) to aerate the culture media and growing cultures with an air-CO<sub>2</sub> gas mixture containing the desired CO<sub>2</sub> levels (Rost *et al.*, 2008), (2) to add equimolar amounts of HCO<sub>3</sub><sup>-</sup> and HCl or (3) to add CO<sub>2</sub>-saturated seawater to a known volume of culture media (Schulz *et al.*, 2009). All of these methods are indistinguishable in terms of their effects on the carbonate chemistry. The method of choice for culture experiments, either an open aerated system or a closed system without headspace (Figure 5.1), will depend on the questions addressed, and on the phytoplankton species that are under investigation. In general, large or fragile phytoplankton, such as for example *Trichodesmium erythraeum* and dinoflagellate species, might be affected by the turbulence created by aeration. Thus, the effect of aeration and bubble size on growth rate and the general physiology of a phytoplankton species should be assessed in preliminary experiments. The goal of culturing phytoplankton in either batch cultures or chemostats is often to optimise cell yield. This is reflected by the frequent use of nutrient-rich culture media and high cell density at harvest. Ocean acidification research has a different goal; rather to accurately represent the present and future

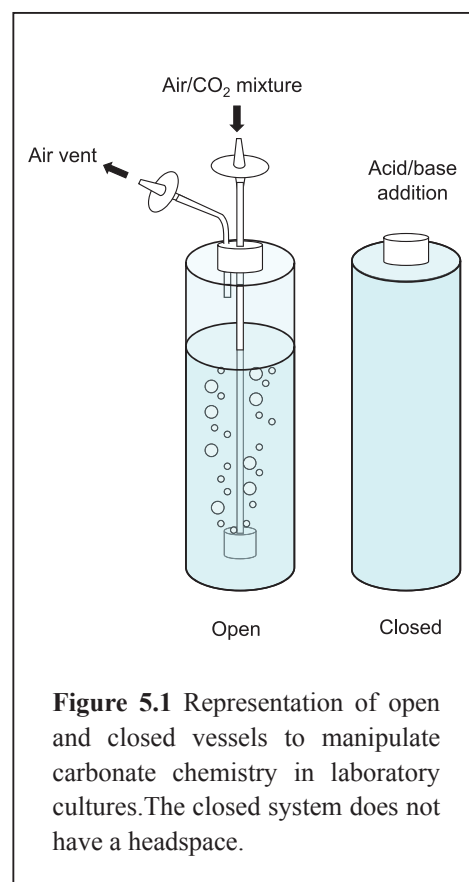

**Figure 5.1** Representation of open and closed vessels to manipulate carbonate chemistry in laboratory cultures. The closed system does not have a headspace.

carbonate chemistry in the ocean. In all types of experiments involving culturing techniques, this will require working at low cell density to avoid undesired change in the carbonate chemistry during the experiment, as recommended in chapter 2 of this guide.

### 5.2 Approaches and methodologies

#### 5.2.1 Culture media

Culturing phytoplankton requires the preparation of a sterile, nutrient-enriched seawater medium. The variable nutritional requirements of the diverse phytoplankton species and the particular questions addressed by different investigators have led to the formulation of diverse culture media. The detailed description and composition of several commonly used culture media can be found on homepages of various culture collections (e.g. <https://ccmp.bigelow.org/node/73>) and only basic principles are discussed here. Seawater sterilisation techniques include autoclaving, microwaving, UV irradiating or filtering through a 0.22  $\mu\text{m}$  filter. The effect of some of these sterilisation techniques on the carbonate chemistry have been discussed in chapter 2. While autoclaving is the most effective method of sterilisation, a drawback of this approach is the resulting degassing of the medium, which significantly affects the carbonate chemistry. It is important to re-equilibrate the autoclaved medium with sterile air or an appropriate air/ $\text{CO}_2$  mixture.

Although many researchers use natural seawater for the preparation of enriched culture media, artificial seawater-based media have been developed for experimental work that requires a completely defined seawater composition, for example to avoid uncharacterised dissolved organic matter found in natural seawater. Additionally, an artificial seawater culture medium is useful when access to clean, oceanic water is restricted or when seasonal variations in the seawater composition affect reproducibility of culture conditions. The classical formulation of nutrient amendment of f/2 (882  $\mu\text{mol kg}^{-1}$   $\text{NaNO}_3$ , 36.2  $\mu\text{mol kg}^{-1}$   $\text{NaH}_2\text{PO}_4$ , 106  $\mu\text{mol kg}^{-1}$   $\text{Na}_2\text{SiO}_3$ ) is specifically targeted for growing coastal diatoms (Guillard, 1975). Dilutions of the f/2 nutrient amendment, for example f/50, are often used when working with phytoplankton species that prefer lower nutrient concentrations such as, for example, *Emiliana huxeyi*. K medium (Keller & Guillard, 1985; Keller *et al.*, 1987) designed especially for the growth of oceanic phytoplankton, includes many nutrients not present in the classical f/2 media derivatives, such as  $\text{NH}_4\text{Cl}$  and  $\text{Na}_2$  b-glycerophosphate, and selenium. The 10 times higher chelation of trace metals by ethylenediaminetetraacetic acid (EDTA) in K medium helps achieve good growth of oceanic species that are generally more sensitive to trace metals than their coastal counterparts. Similarly, there exist several formulations of artificial seawater media but the most widely used are ASW (Goldman & McCarthy, 1978), ESAW (Harrison *et al.*, 1980; Berges *et al.*, 2001), and AQUIL (Morel *et al.*, 1979; Price *et al.*, 1989), the latter being a specific medium for the study of trace metal speciation. Marine photosynthetic diazotrophs such as *Trichodesmium erythraeum* are grown in YBCII, an artificial seawater medium free of fixed nitrogen species (Chen *et al.*, 1996). SN medium for marine cyanobacteria (Waterbury *et al.*, 1986) prescribes the addition of 100  $\mu\text{mol kg}^{-1}$   $\text{Na}_2\text{CO}_3$  to the natural seawater. In summary, no universal culture medium suitable for the growth of all phytoplankton exists, because specific groups of phytoplankton require specialised media. It is therefore very important to report precisely the constituents of the culture medium, when possible using the appropriate citation, and when applicable, describing any modifications made to the original formulation. For natural seawater media, the collection point, the collection date and background nutrient concentrations of the water should be reported, as well as any treatment that could have modified the chemistry of the seawater.

#### 5.2.2 Selection of phytoplankton strains

The choice of phytoplankton species, strains and clonal isolates can have a significant effect on the outcome of the experimental work. Definitions and concepts related to phytoplankton strains have been reviewed by Lakeman *et al.* (2009). It is important to acknowledge that the first selection step in a microalgal culture is the isolation of the targeted organism in culture. Isolation methods, such as single cell picking, sorting by flow cytometry or enrichment cultures followed by end-point dilution all introduce some bias in selection pressures. Following isolation, the establishment of the culture will also lead to selection of organisms that are best suited

for the culture conditions, which may not necessarily reflect the natural conditions. The establishment of a new culture after the initial isolation process will eventually lead to genetic adaptation of the strain, as selection processes drive the phenotype of the culture to a new optimum. Maintenance of cultures will vary between laboratories and this can lead to divergence of the initial strain into several distinct phenotypes, potentially leading to variation in experimental results between investigators. The coccolithophorid *Emiliania huxleyi* is particularly prone to changes in phenotype during long-term culturing of stock cultures, sometimes leading to the loss of calcifying ability with time. Media rich in nutrients leading to high cell density, as well as prolonged periods of time in the stationary phase, may cause this shift in phenotype (Paasche, 2001; Lakeman *et al.*, 2009). Alternatively, it can also be argued that the culturing environment is less variable than the natural environment, and may lead to the accumulation of conditionally neutral mutations that are purged only under more stressful conditions. Stress tolerance may therefore be modified or lost in long-term culturing of a strain.

Readers are referred to the review of Lakeman *et al.* (2009) for detailed recommendations to address the effects of various evolutionary processes that can occur when working with cultures. Some general recommendations are listed below:

1. The use of cryopreserved phytoplankton strains whenever possible would reduce the impact of mutations. Most commercially available phytoplankton strains from major culture collections are cryopreserved and would allow comparisons of experiments conducted several years apart with the same starting genetic material.
2. The effect of recombination can be minimised by avoiding sexual reproduction.
3. Small population bottleneck causing genetic drift can be avoided by frequent transfers of large inocula.
4. Culture conditions should mimic the natural conditions of the isolates as closely as possible.
5. Culture conditions, strain description and source should be described as completely as possible. A small sample of the cells should be collected and frozen at the time of the experiments to allow for future verification of the strain identity and its genetic makeup. This may be important in cases where different investigators are obtaining divergent results with a presumed common strain.

Although cultures obtained from culture collection are monoalgal, they are not always axenic, i.e. free of contaminating bacteria. Recent phytoplankton isolates require time to become firmly established in culture and cannot immediately be cultured in axenic conditions. The process of rendering a culture axenic is tedious, but is usually an attainable goal if a methodical approach is followed (e.g. Berget *et al.*, 2002). In some cases, the phytoplankton species may grow better when cultivated with the bacterial contaminants. While it can be argued that axenic cultures are not representative of the natural environment, contaminating bacteria introduce an additional level of complexity to culture experiments that cannot always be controlled, as for example in the study of dissolved organic matter. Bacterial contaminants may vary between phytoplankton strains and may no longer have a relevance to the natural environment from which the strain was isolated. Whenever possible, experiments should be carried out with axenic phytoplankton strains, which can be obtained from most major culture collections and are best maintained as stock cultures in autoclaved media. Establishing that a culture is axenic requires microscopic observation with an epifluorescent microscope after staining a filtered culture aliquot with DAPI or acridine orange. Simple observations of a culture with a light microscope are not sufficient to ascertain that a culture is axenic. The addition of 1 ml of marine broth (e.g. Difco™ Marine Broth 2216) to a 2 ml culture aliquot, together with appropriate controls (e.g. sterile culture medium) incubated for several days and examined by epifluorescence microscopy also provides additional evidence of sterility when bacteria are in low abundance in the phytoplankton culture (Berget *et al.*, 2002). Stock cultures and transfer media should be tested for bacterial contamination with every maintenance transfer. When a strain cannot be obtained as an axenic culture or if recent isolates contain bacterial contaminants, it may be important to identify the phylogenetic affiliation of the contaminants using molecular biological methods such as ribotyping (e.g. sequencing of the 16S rRNA gene).

### 5.2.3 Batch cultures

Batch cultures are generally used when studying growth in the presence of excess nutrients. Predetermined nutrient concentrations are added to the culture medium, with the essential macro- and micronutrients provided in a fixed ratio, which is usually a variation of the classical nutrient-rich f/2 medium (Guillard, 1975). Classical batch cultures in rich nutrient medium have the potential to reach very high biomass and are prone to large shifts in carbonate chemistry. After a short lag phase, growth is exponential and represents the maximum growth rate achievable under the selected light and temperature conditions. After a period of exponential growth, a stationary phase is reached, often because one of the nutrients is exhausted. Alternatively, cells may reach their upper pH limits or become CO<sub>2</sub> limited long before nutrients become limited in nutrient-rich medium (e.g. Hinga, 2002; Hanseret *et al.*, 2007). The initial amount of pre-adapted cells that is inoculated to initiate an experiment will have an effect on the length of the time lag preceding exponential growth. A large inoculum can shorten the time lag to a minimum, but under these initial conditions, some cultures will quickly reach high cell densities, which may change the growth conditions and the carbonate chemistry. The need to keep the carbonate chemistry as constant as possible in ocean acidification research has led to the development of dilute batch culturing of phytoplankton. Under dilute growth conditions, the phytoplankton biomass at the time of harvest should have drawn down less than 5% of the total dissolved inorganic carbon (DIC) in the culture medium (Zondervan *et al.*, 2002). The dilute batch cultures are usually carried out at lower nutrient concentrations than the classical f/2 medium with a N:P ratio of 24. In contrast, typical nutrient concentrations used in dilute batch cultures are around 100 μmol kg<sup>-1</sup> nitrate and 6.25 μmol kg<sup>-1</sup> phosphate (Zondervan *et al.*, 2002; Langer *et al.*, 2009), with an N:P ratio of 16.

In all types of cultures, it is important to ensure good pre-conditioning of the microorganisms. The pre-culture should be grown at the same experimental conditions (light, temperature and nutrients) as the experimental cultures for more than five generations. Pre-culturing of the cell inoculum can be done in a small volume as long as the cultures are kept at low cell density and in the exponential phase until the onset of the experiment. After inoculation with the pre-culture, the experimental culture should be grown for 5 to 10 generations in the exponential growth phase before harvesting. The maximum cell density that can be sustained at the time of harvest, without introducing large changes in the DIC (<5%) will decrease with increase in species cell size, and can be estimated from the cell carbon quota of a given phytoplankton species. Empirical relationships between cell volume and cell carbon quota can provide a first order approximation of the targeted cell density when planning experiments (Mullin *et al.*, 1966). For coccolithophores such as *E. huxleyi*, a typical inoculum and final cell concentration at the time of harvest are in the range of 30 to 100 cells ml<sup>-1</sup>, and 50,000 to 60,000 cells ml<sup>-1</sup>, respectively. The size of the inoculum as well as the final cell density of the culture that can be reached without significant changes in the carbonate chemistry are thus prescribed by the cellular carbon quota.

For all culture types, it is important to carefully choose the time of sampling and keep this routine throughout the experiment because cell division can be synchronised by the light/dark cycle prevailing in the laboratory incubations or in the field (van Bleijswijk *et al.*, 1994; Zondervan *et al.*, 2002). If cultures are grown under continuous light, i.e. rather artificial conditions for most phytoplankton, the responses can differ strongly from those observed under more realistic light conditions (e.g. Rost *et al.*, 2006). Similarly, it is important to mix cultures at least daily to prevent settling of cells. This is more important for cultures that are not continuously aerated with an air/CO<sub>2</sub> mixture and can be done manually by gentle inversion of the culture bottles, continuous rotation, or by a stirring rod. Stir bars should be avoided whenever possible because they can lead to damage in larger cells, such as dinoflagellates.

### 5.2.4 Grow outs or bioassay experiments

Grow outs or bioassay experiments are a type of batch cultures carried out with natural microbial communities, for example on shipboard field experiments. They are often combined with nutrient additions and serve a special purpose in identifying the nutrient that is limiting primary production or other biological processes. Classical examples of successful applications of bioassay experiments in oceanographic research are those of Ryther & Dustan (1971) and

Martin & Fitzwater (1988). The latter provided the first evidence that iron was a limiting nutrient in the high-nutrient, low-chlorophyll (HNLC) regions. Bioassay experiments are usually incubated for one to several days depending on the oligotrophy level of the water with which they are performed, and their main purpose is to determine the short-term physiological response of the microbial community to a treatment. Short-term incubations while minimising bottle effects do not allow the assessment of the full acclimation potential of the natural microbial community. In bioassay experiments, the nutrient enrichments are small compared to the concentrations added to culture media, and are normally of the order of 1 to 2  $\mu\text{mol kg}^{-1}$  of nitrate or ammonium, and 0.1 to 0.2  $\mu\text{mol kg}^{-1}$  phosphate. Compared to experiments conducted with monoalgal cultures, larger volumes are required to obtain enough biomass to carry out physiological rate measurements such as carbon and nitrogen fixation. Grow outs or bioassays are a simple way to carry out the manipulation in the field or at sea. However, the confinement of natural populations in a small bottle of 1 to 5 l may lead to bottle effects and heterotrophic bacterial growth, and grazing may be a problem in certain areas. The effect of grazers could be monitored by control incubations with and without grazers (Landry *et al.*, 1995), and shifts in microbial community structure can be monitored using molecular biological techniques. As for monoalgal culture experiments, equilibration to reach the desired  $\text{CQ}$  levels can be carried out either by  $\text{HCl}/\text{HCO}_3^-$  addition in equimolar ratio by aerating with an air- $\text{CO}_2$  gas mixture, or by the addition of a known volume of sterile-filtered water with saturated  $\text{CO}_2$  concentration (see chapter 2). As for culture experiments, measurements of at least two parameters of the carbonate system are needed to confirm that the targeted  $\text{CQ}$  levels have been achieved. Grow out experiments and bioassay experiments are usually carried out over a period of a few days, and are generally too short to assess the effect of a particular treatment on microbial species succession. In oligotrophic areas, the incubated water samples will rapidly become nutrient-limited without the addition of nutrients. Short-term bioassay experiments, lasting a few days only, assess the physiological state and physiological acclimation of the microbial population present at the time of sampling.

Owing to the sluggish air-water gas exchange and reaction kinetics involved in  $\text{CO}_2/\text{HCO}_3^-$  interconversion, the equilibrium of certain carbonate species establishes very slowly. Depending on temperature, target  $\text{p}(\text{CO}_2)$ , water volume and the aeration rate, the pre-conditioning of the seawater to the target  $\text{p}(\text{CO}_2)$ , may take place over the whole duration of the experiment. It is therefore important to document the experimental conditions with adequate measurements of the carbonate system in order to allow the calculation of the  $\text{p}(\text{CO}_2)$  levels at the start and the end of such experiments. Some of these problems can however be circumvented by diluting/exchanging with filtered pre-acclimated seawater at given time intervals as discussed in the next section on semi-continuous batch incubations (e.g. Tortell *et al.*, 2002, 2008).

### 5.2.5 Semi-continuous cultures

Semi-continuous cultures are different from traditional batch cultures in that the organisms can be maintained in exponential growth for long periods of time. Semi-continuous cultures have been very useful for studying the effect of trace metal limitation in phytoplankton (Sunda & Huntsman, 1995) and are currently applied to ocean acidification research (e.g. Kranz *et al.*, 2009). Logistically, these are easier to conduct than continuous cultures because the cultures can be diluted daily or once every few days, depending on the growth rate of the species under the experimental conditions. They do not require pumps and sophisticated instrumentation. However, prior information on growth rate is required in order to adjust the dilution frequency of the cultures every day in order to keep the cells in the exponential growth phase and the biomass to an optically thin cell density.

The difference in the cell density between semi-continuous and batch cultures is seen in Figure 5.2. As for the batch culture, the achieved growth rate is not determined by nutrients but rather depends on the light and temperature conditions. In such cultures, growth rates are not fixed by the dilution rate, and can be measured from the increase in cell density between a time interval. As for batch cultures, sampling should be done at roughly the same time every day to avoid diel variations in the physiological conditions of the cells.

Variations on the semi-continuous culture design have also been used in shipboard field experiments with natural microbial communities (Tortell *et al.*, 2002, 2008). These can be carried out longer than grow out

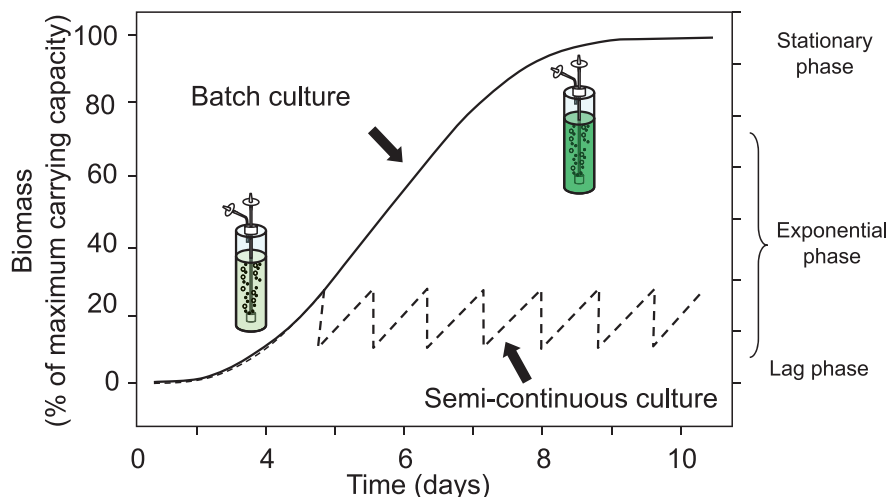

**Figure 5.2** Differences in the biomass levels between batch and semi-continuous cultures. In semi-continuous cultures, the biomass is maintained at a low level for the duration of the culturing period in order to reduce the change in growth conditions. The time period between the dilutions of the culture will vary as a function of the growth rate and the desired biomass (redrawn from Hutchins *et al.*, 2003).

experiments because the incubation water is periodically exchanged with fresh filtered seawater pre-acclimated to the desired  $\text{CO}_2$  level. Such semi-continuous batch incubations can be carried out for several days and are useful in assessing the effect of  $\text{CO}_2$  on growth rate of natural microbial populations and on short-term changes in community structure (e.g. Tortell *et al.*, 2008).

### 5.2.6 Chemostats

A chemostat is a bioreactor that has reached equilibrium such that the chemical properties (pH, nutrients, cell density) remain constant with time (Novick & Szilard, 1950). In these systems, the input and output flow rates are the same and the experimentalist can define the growth rate of the organisms as a function of the dilution rate of a limiting nutrient (Figure 5.3). Chemostats are thus particularly useful to study the physiological response of microorganisms under nutrient-limited conditions, as observed in oligotrophic oceans. In order to be meaningful, it is important that the chemostat culture reaches steady-state. A chemostat can be deemed to be at steady-state when measured variables, such as for example cell density, or particulate organic carbon (POC), remain constant for 3 to 4 consecutive days. This is usually achieved after the cells have grown for 10 to 15 generations, but can sometimes be reached faster, depending on the physiological status of the inoculum.

Depending on the size of the incubator and the dilution rate, large volumes of media may be required to run chemostats. It is important to pre-equilibrate the culture media to the required  $\text{CO}_2$  concentration by aerating the media reservoir for a few days before pumping it in the culture vessel or by employing another of the methods recommended in chapter 2. Once the chemostat is started, the culture vessel should continue to be aerated with the desired  $\text{CO}_2$  concentration for the duration of the experiment. Pre-equilibration of the culture medium gives the carbonate chemistry a chance to equilibrate in the seawater, without the effect of biological  $\text{CO}_2$  drawdown. In cases where aeration has a negative effect on the cultured phytoplankton species, one can choose to purposely manipulate the  $p(\text{CO}_2)$  of the medium and chemostat to be higher than the target value in order to compensate for the expected biologically-induced shift in carbonate chemistry. Whether the culture is aerated or not, it is important to measure the carbonate chemistry in the chemostat culture at the beginning of the experiment and at the time of harvest in order to determine the  $p(\text{CO}_2)$  value to which the phytoplankton was exposed.



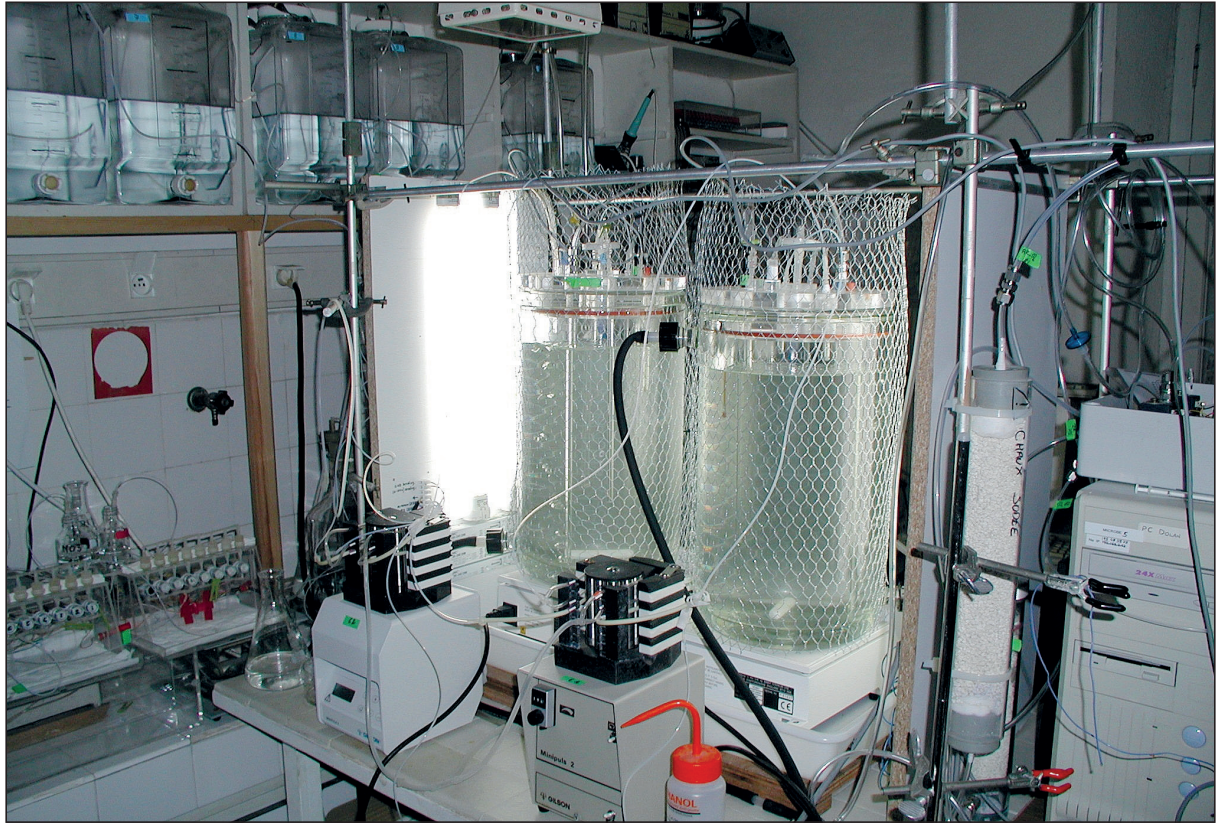

**Figure 5.3** Chemostat used by Sciandra *et al.* (2003) to investigate the response of *Emiliana huxleyi* to elevated  $p(\text{CO}_2)$  (photo credit: J.-P. Gattuso).

At steady-state, the biomass ( $x$ ) and growth rates ( $\mu$ ,  $\text{d}^{-1}$ ) of the algal species in the chemostat are usually determined by the concentration of the limiting nutrient ( $S_n$ ) and the dilution rate ( $D$ ,  $\text{d}^{-1}$ ), respectively according to the following equations:

$$x = \frac{S_{n_0} - S_n}{q}; \quad (5.1)$$

$$\mu = D; \quad (5.2)$$

where  $x$  is the cell abundance ( $\text{cell l}^{-1}$ ),  $S_{n_0}$  the concentration of the limiting nutrient in the medium reservoir ( $\text{mol kg}^{-1}$ ),  $S_n$  is the concentration of the nutrient inside the incubator ( $\text{mol kg}^{-1}$ ),  $q$  is the cell quota ( $\text{mol cell}^{-1}$ ). More detailed mathematical descriptions of the chemostat can be found in Monod (1950), Droop (1974), Janasch (1974) and Burmaster (1979).

In chemostats, the limiting nutrient is set by reducing its concentration relative to the other essential nutrients. In the case of a nitrate-limited or phosphate-limited chemostat, this would require supplying N:P at a ratio much below or much above the Redfield N:P ratio of 16, respectively. Since large amounts of media are required for chemostat cultures, some valuable time and media can be saved if the inoculum is pre-adapted to the experimental conditions first, as for a batch culture. Some algae can store significant amounts of excess nutrients, for example iron and phosphorus, and reducing the cell quota of the pre-inoculation culture to a limiting level will help reach steady-state more rapidly, for example after 5 to 6 generations. Most chemostats are therefore initially started as batch cultures, which grow at the maximum growth rate. Once biomass has reached the desired cell density, the flow rate of the input media is set to the desired rate and the outflow from the culture vessel removes the excess media at the same rate. After 5 to 15 generations, the phytoplankton growth rate should have adjusted to steady-state. To achieve steady-state growth rates, the constancy of growth

## Part 2: Experimental design of perturbation experiments

conditions must be maintained (flow rate, temperature,  $p(\text{CO}_2)$ , nutrient concentration and composition). Bacterial contamination is often a problem for chemostat cultures because bacteria tend to thrive in nutrient-limited phytoplankton cultures. In order to prevent contamination of the sterile medium reservoir, it is important to interrupt the liquid path by one or several air breaks in the tubing because bacteria do not travel upstream as easily through air as through liquid media (Figure 5.4). In addition, continuous mixing of cultures in the chemostat is necessary to avoid sedimentation of cells and to minimise wall growth.

Continuous light does not mimic natural conditions in most regions and most experiments are carried out with a light-dark cycle (Leonardos & Geider, 2005). Such culture systems are called *cyclostats* because a cyclic behaviour in the growth rates and other physiological rates is imposed by the light-dark regime (Gotham & Rhee, 1982). In continuous culture systems, the microorganisms can be grown over a range of low to high growth rates that reflect the degree of nutrient limitation. However, once the dilution rate is approaching the maximum growth rate, the culture will start washing out rapidly. For scientific questions that require high growth rates, a system like a semi-continuous culture or a batch culturing system is more appropriate.

A few chemostat experiments have been conducted at sea, to study the effect of a constant low supply of the limiting nutrient Fe (iron) on phytoplankton growth in HNLC regions (Hutchins *et al.*, 2003). This is logistically difficult to conduct; requiring large volumes of amended seawater media, the need to acid wash the whole chemostat apparatus and incubating large culture volumes (2.7 l) in replicates for each growth condition. It is more difficult, if not impossible, to achieve steady-state of the chemostats with complex field populations, which are usually grown under the ambient fluctuating light intensities (Sommer, 1985). In contrast to grow outs or bioassay experiments which assess the nutrient that limits primary production, shipboard chemostat experiments have the added advantage to allow the study of microbial communities at low nutrient input, more representative of the natural conditions. These experiments can be maintained for several days at a constant dilution rate.

Daily sampling of chemostat cultures should be limited to less than 10 to 15% of the culture volume to avoid significant perturbation of the steady-state. If possible, carbon dioxide in the inlet of the culture vessel should be continuously monitored by an infrared gas analyser in line with the culture vessel. However, constant monitoring by infrared gas analysers can become quite expensive when several chemostats with different  $\text{CO}_2$  concentrations are run in parallel. Continuous measurements of pH and temperature of the seawater with pH/T-probes inserted directly into the culture vessel could be used as a more economical alternative. However, the lower precision of pH electrodes requires occasional measurements of DIC and  $A_T$  to precisely characterise the state of the carbonate system in the culture media. For cyclostats, an operational definition of steady-state

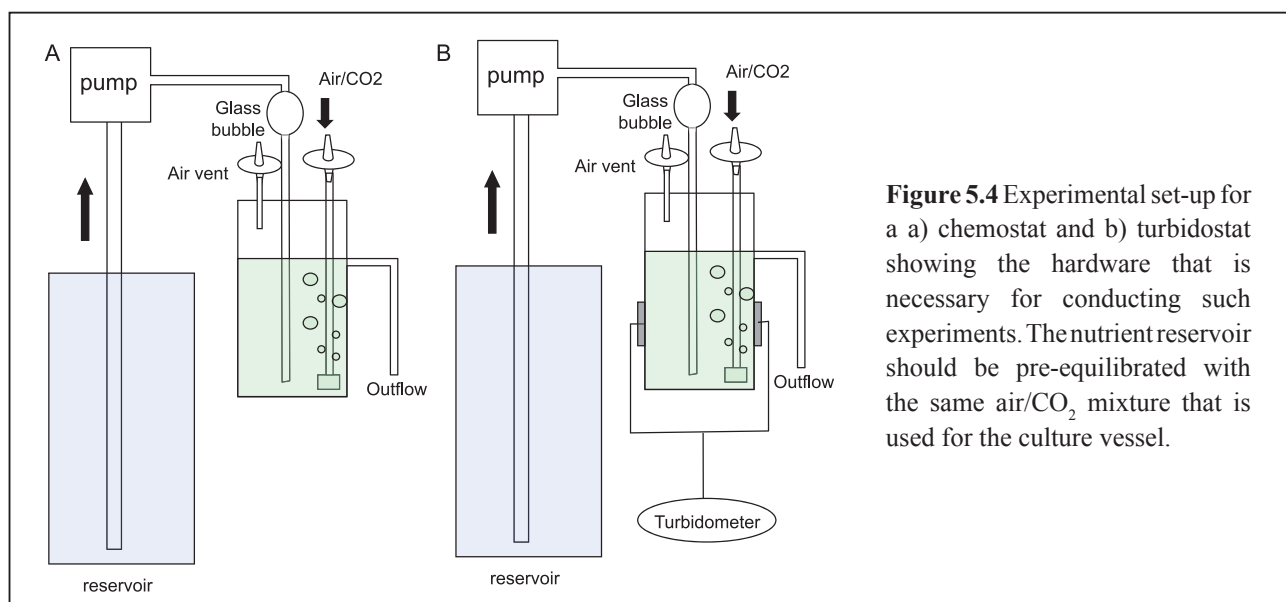

**Figure 5.4** Experimental set-up for a) chemostat and b) turbidostat showing the hardware that is necessary for conducting such experiments. The nutrient reservoir should be pre-equilibrated with the same air/ $\text{CO}_2$  mixture that is used for the culture vessel.

should be established. Other investigators have used less than 10% variation in biomass, determined either from cell density or chlorophyll, for at least three days as a measure of steady-state (Leonardos & Geider, 2005). As for other types of cultures, sampling should always be carried out at the same time of the day.

Additional concerns arise in the use of chemostat cultures for ocean acidification research. It is well established that in nutrient-limited chemostats, and in particular nitrogen-limited chemostats, the C:N molar ratio of the phytoplankton can greatly exceed the Redfield ratio of 6.6 (Goldman *et al.*, 1979). In fact, the C:N ratio varies largely as a function of the dilution rate, being highest at low dilution rates. This means that photosynthetic drawdown of DIC will not necessarily be in balance with the set growth rate and at low dilution rates, biological drawdown of CO<sub>2</sub> may quickly exceed CO<sub>2</sub> delivery by bubbling at a constant rate, because of an increased retention time of the cells in the culture vessel. Thus, care should be taken to assess at least two parameters of the carbonate chemistry (pH, DIC,  $A_T$ ) at all dilution rates as it may vary significantly between chemostats run at different dilution rates. One would expect the strongest shift in carbonate chemistry at the lowest dilution rates, especially when the cell abundance is high.

Special caution is required when working with calcifying algae in culture systems, because of the effect of calcification on the carbonate chemistry of seawater. Due to the drawdown of carbonates by the cells, the alkalinity in the incubator becomes lower than that in the medium reservoir, and the carbonate chemistry of seawater, and thereby pH, deviates strongly from target chemistry despite continuous aeration (see chapter 2 for explanations). In principle, there are two ways to minimise effects of calcifying algae on the carbonate system in a chemostat: a) to reduce cell abundance, and therewith the amount of alkalinity drawdown within the incubator and, b) to increase the daily addition of alkalinity from the reservoir, for example by increase of alkalinity in the reservoir (Borchard *et al.*, *subm.*). The maximum abundance of calcifying algae in a chemostat that can be sustained by a given total alkalinity can be estimated from:

$$n = \frac{1}{c} D(A_{T_m} - A_{T_i}); \quad (5.3)$$

where  $n$  is the maximum sustainable abundance of cells (cells l<sup>-1</sup>),  $D$  is the dilution rate (d<sup>-1</sup>),  $c$  is the cell specific change in alkalinity due to calcification (μmol cell<sup>-1</sup> d<sup>-1</sup>), and  $A_{T_m}$  and  $A_{T_i}$  are the total alkalinity (μmol l<sup>-1</sup>) within the medium reservoir and the target alkalinity in the incubator, respectively. Because calcification rate may change with growth rate, for example for *E. huxleyi*,  $c$  should be known for each dilution rate, or conservatively estimated in order to avoid significant reduction of alkalinity or even carbonate undersaturation.

The choice of method to minimise biological effects on carbonate chemistry in a chemostat will depend on the purpose of the experiment but ideally, cell abundance should be kept as low as possible. Thus, assays to study ocean acidification with chemostats clearly differ from classical chemostat studies that opt for high biomass yield. In summary, the strong drift in carbonate chemistry, which can vary in magnitude for different dilution rates, may complicate the analysis of the data and certainly requires caution when designing experiments with chemostats. Similarly, the p(CO<sub>2</sub>) in the aerating gas is not necessarily equal to the p(CO<sub>2</sub>) in the medium, and it is important to measure two parameters of the carbonate system in the culture itself rather than in the inflowing medium or gas mixture.

### 5.2.7 Turbidostats

A turbidostat is a continuous culturing method where the dilution with fresh culture medium does not take place continuously but only to restore the turbidity of the culture, thus keeping the biomass constant. This is achieved by measuring turbidity, or chlorophyll fluorescence through sensors placed on the outside of the culture vessel. It is very similar in principle to the semi-continuous culture approach but more complex to set up instrumentally. Logistically, turbidostats and chemostats are much more difficult to set up than batch cultures because they require peristaltic pumps and large volumes of media. In addition, the increased complexity makes them susceptible to bacterial contamination, cell wall growth and creeping of the cultured cells into the reservoir of fresh medium.

### 5.3 Strengths and weaknesses

#### 5.3.1 Batch cultures

##### *Strengths*

Batch cultures are easy to set up, conduct and replicate. They require minimal equipment compared to other culture types. If the starting culture is axenic, it is easy to maintain the batch cultures free of contaminating bacteria by following good standard microbiological techniques. The exponential growth phase should represent the maximum growth rate under a given light and temperature regime. They are suitable for questions that require nutrient replete conditions or bloom conditions.

##### *Weaknesses*

The growth conditions within the classical batch culture are changing rapidly, because the organisms are almost never in balanced growth, while those of the dilute batch culture are more stable. Dilute and classical batch cultures are of fixed volume, which means that the number of samples that can be removed is limited. They are poor models for oligotrophic regions. The results obtained from classical batch cultures are more difficult to reproduce than those from chemostats. This is because of the rapid changes that occur as biomass increases and starts modifying first the carbonate system, then the nutrients and the light environment. This means that they are also not particularly well suited for global gene expression studies and all of the associated -omics methods where reproducibility is very important for detecting small changes in the metabolic status. In general, dilute batch cultures are more appropriate for ocean acidification work than the classical batch cultures. However, the low biomass yield means that large volumes of dilute cultures are sometimes required to carry out the analyses. The results of the batch culture will be very dependent on the physiological status of the cell inoculum. It should be stressed here that pre-acclimation of the inoculum to the set experimental conditions can greatly minimise or eliminate the lag-phase.

#### 5.3.2 Bioassays and grow outs

##### *Strengths*

The advantages are similar to those of batch cultures, except that mixed microbial populations are used for the incubations. They are simpler to conduct at sea than continuous cultures which require more sophisticated equipment. In combination with nutrient additions, they can uncover the nutrient that is most likely to limit productivity in a given environment.

##### *Weaknesses*

In coastal areas where nutrients are high, grow outs will be subject to the same disadvantage as the batch cultures. In oligotrophic areas, large volumes need to be incubated in order to get accurate measurements, as is the case for nitrogen fixation measurements using the  $^{15}\text{N}_2$  gas technique. Except for bloom conditions, where nutrients are injected through mixing in the euphotic zone, the mode of pulsed nutrient delivery used in bioassay experiments is unrealistic for most of the ocean. Variability in the initial microbial populations, initial environmental conditions and the pre-conditioning of the microbial populations cannot be controlled in bioassay experiments, making this approach much more difficult than batch culture experiments with monospecific cultures.

#### 5.3.3 Semi-continuous cultures

##### *Strengths*

The growth of semi-continuous cultures is maintained in exponential phase, and it is therefore easier to sample the culture at the same physiological state in repeated experiments than in batch cultures. It is an appropriate type of culture for determining the maximum growth rate achievable under a set of experimental conditions, because repeat measures can be made on the same culture. They are simpler to conduct than true continuous cultures such as chemostats and turbidostats. They can be used to study micronutrient limitation, for example

Fe limitation when used in combination with high concentrations of chelators in the culture media. However, care should be taken with chelators such as EDTA because they impede calculations of the carbonate system via  $A_T$  (see section 2.4.3 of this guide).

#### ***Weaknesses***

Depending on the level of automation in the experimental set-up, semi-continuous cultures may require daily attention to maintain the cell density.

### **5.3.4 Chemostat cultures**

#### ***Strengths***

Chemostat cultures are especially useful when looking at nutrient-limited growth but in addition they offer reproducibility of growth conditions. The mathematical description of cellular growth in a chemostat is a definite advantage for transferring the gained knowledge into mathematical models. Recently, there has been resurgence in popularity of chemostats because of the reproducibility that they offer for studies involving transcriptomics, proteomics and metabolomics. Although a cell culture pre-adapted to the growth conditions will reach steady-state faster once the chemostat mode is started, the physiological state of the inoculum culture will not affect the results once the culture has reached steady-state and the growth rate is equal to the dilution rate. Chemostats are particularly useful when studying dissolved organic matter (DOM), since the release of DOM by the autotrophic cell is often associated with nutrient limitation.

#### ***Weaknesses***

Chemostats are easily contaminated with bacteria, even when practicing good microbiological sterile techniques, and they require large amounts of culture media and sophisticated equipment. Establishing steady-state in a chemostat requires the microorganisms to grow for up to 15 generations. After several weeks, wall growth may be a problem as well as growth in the lines leading to the medium reservoir.

### **5.4 Potential pitfalls**

For all of the culture methods, there is a potential for the biomass to be high enough to significantly deplete the dissolved inorganic carbon in the culture media, followed by additional changes in the growth environment such as self-shading. In batch cultures, nutrient depletion can be a problem when low nutrient concentrations are used to maintain the biomass low. Some phytoplankton species may not like the turbulence caused by aeration and might grow at suboptimal growth rates under these conditions. Aeration should therefore be gentle and applied only as much as necessary.

In order to homogenise the supply of cells with respect to light,  $\text{CO}_2$  and nutrients, and also to avoid accumulations of cells and of metabolic waste products, the cultures need to be well mixed. Besides aeration, mixing can be accomplished by means of agitation with static stirrers. If magnetic stirring is applied, the direct contact between the magnetic stirring bar and the vessel bottom should be avoided as this may cause cell damage, DOM release and foam generation.

Care should be taken to minimise temperature fluctuations during incubations, because  $\text{CO}_2$  dissolution in seawater and the rates of the majority of enzymatic reactions varies as a function of temperature. This can best be achieved by placing smaller culture vessels, for example batch cultures, in a water bath or by having temperature controlled incubators or facilities where the cultures can be set up.

### **5.5 Suggestions for improvements**

Under all growth conditions, the cultures should be kept at optically thin cell densities in order to limit the depletion of DIC to less than 5% of the total. Batch cultures should be monitored regularly and be harvested before the onset of changes in carbonate chemistry, unless the goal of the study is to simulate bloom conditions. A simple measurement

## Part 2: Experimental design of perturbation experiments

of the phytoplankton variable fluorescence ( $F_v/F_m$ ) can be used to screen for nutrient limitation. Test for axenicity (bacterial contamination) should be conducted in each culture at harvest as described in section 5.2. In order to ascertain the identity of phytoplankton strains and to anticipate potential issues of genetic drift due to long-term cultivation, a small amount of the culture should be harvested and stored frozen at  $-80^{\circ}\text{C}$  for future references. Some cultures that do not grow well axenically may contain variable bacterial contaminants. The frozen culture sample can also be used for identifying the bacterial contaminants associated with the phytoplankton strains.

### 5.6 Data reporting

For batch cultures, it is important to report basic information characterising the physiological state of the initial inoculum. Records should include full details on the origin of the strain used in the experiment, cell density and detailed growth conditions of the pre-acclimated culture, number of cells inoculated, the Chl cell, light intensity, temperature and composition of the initial culture media. Additionally, a measure such as  $F_v/F_m$  would give information on whether the pre-acclimated culture was in exponentially growing phase. In addition to the specific experimental data collected by each investigator, it is important that the growth and two parameters of the carbonate system be reported for the main cultures when carrying out experiments at different  $\text{CQ}$  levels (see chapters 1 and 2). The carbonate system should be measured at the beginning and the end of the experiment, as well as in the culture medium. The investigators should report initial and final measurements of the carbonate system parameters, and should clearly indicate in the data analyses whether initial, final or mean values were used. The investigators should also report whether or not the cultures were axenic. As a suggestion, it may be useful to freeze a small amount of each culture for future nucleic acid extractions. This may prove important to resolve issues about possible heterogeneity in the physiology of different strains of a given species.

### 5.7 Recommendations for standards and guidelines

1. Keep biomass low to avoid depletion of DIC, self-shading and undesired nutrient limitation.
2. Drawdown of DIC by biological carbon fixation in any type of cultures should be less than 5% of the total DIC.
3. Axenic strains of phytoplankton should be used whenever possible.
4. Nucleic acid samples from culture strains should be collected on a  $0.2\ \mu\text{m}$  filter for future reference.
5. For batch culture experiments, the pre-culture should be acclimated to the same conditions as applied in the experiments and dilute batch cultures should be used.
6. Cultures should be run in replicates (triplicates) and the entire experiment should be replicated at least twice with different batches of culture media.
7. The DIC system should be characterised by at least two independent measurements at the beginning of the experiment and at the time of culture harvest in order to assess any drift in the carbonate chemistry. Depending on the questions addressed in the experiment, replicates that are not within the acceptable range of variation in DIC should be clearly reported and possibly left out of the further data analyses.
8. Chemostats should be used when studying the effect of  $\text{CO}_2$  levels on growth under nutrient-limited conditions.
9. For chemostat cultures, the effluent volume and the cell density should be measured every day.

### 5.8 References

Berg G. M., Repeta D. J. & LaRoche J., 2002. Dissolved organic nitrogen hydrolysis rates in axenic cultures of *Aureococcus anophagefferens* (Pelagophyceae): comparison with heterotrophic bacteria. *Applied and Environmental Microbiology* 68:401-404.

- Berges J. A., Franklin D. J. & Harrison P. J., 2001. Evolution of an artificial seawater medium: improvements in enriched seawater, artificial water over the last two decades. *Journal of Phycology* 37:1138–1145.
- Burmester D. E., 1979. The continuous culture of phytoplankton: mathematical equivalence among three steady state models. *American Naturalist* 113:123-134.
- Chen Y. B., Zehr J. P. & Mellon M., 1996. Growth and nitrogen fixation of the diazotrophic filamentous nonheterocystous cyanobacterium *Trichodesmium* sp. IMS 101 in defined media: evidence for a circadian rhythm. *Journal of Phycology* 32:916-923.
- Cullen J. T. & Sherrell R. M., 2005. Effects of dissolved carbon dioxide, zinc, and manganese on the cadmium to phosphorus ratio in natural phytoplankton assemblages. *Limnology and Oceanography* 50:1193-1204.
- Droop M. R., 1974. The nutrient status of algal cells in continuous culture. *Journal of the Marine Biological Association of the UK* 54:825-855.
- Goldman J. C., McCarthy J. J. & Peavey D. G., 1979. Growth rate influence on the chemical composition of phytoplankton in oceanic waters. *Nature* 279:210-215.
- Goldman J. C. & McCarthy J. J., 1978. Steady-state growth and ammonium uptake of a fast-growing marine diatom. *Limnology and Oceanography* 23:695–703.
- Gotham I. J. & Rhee G.-Y., 1982. Effects of nitrate and phosphate limitation on cyclostat growth of two freshwater diatoms. *Journal of General Microbiology* 128:199-205.
- Guillard R. R. L., 1975. Culture of phytoplankton for feeding marine invertebrates. In: Smith W. L. & Chanley M. H. (Eds.), *Culture of marine invertebrate animals*, pp. 26-60. New York: Plenum Publishing Corporation.
- Hansen P. J., Lundholm N. & Rost B., 2007. Growth limitation in marine red-tide dinoflagellates: effects of pH versus inorganic carbon availability. *Marine Ecology Progress Series* 334:63-71.
- Harrison P. J., Waters R. E. & Taylor F. J. R., 1980. A broad spectrum artificial seawater medium for coastal and open ocean phytoplankton. *Journal of Phycology* 16:28-35.
- Hinga K. R., 2002. Effects of pH on coastal marine phytoplankton. *Marine Ecology Progress Series* 238:281-300.
- Hutchins D. A., Pustizzi F., Hare C. E. & DiTullio G. R., 2003. A shipboard natural community continuous culture system for ecologically relevant low-level nutrient enrichment experiments. *Limnology and Oceanography Methods* 1:82-91.
- Janasch H. W., 1974. Steady state and the chemostat in ecology. *Limnology and Oceanography* 19:716-720.
- Keller M. D. & Guillard R. R. L., 1985. Factors significant to marine diatom culture. In: Anderson D. M., White A. W. & Baden D. G. (Eds.), *Toxic dinoflagellates*, pp. 113-116. New York: Elsevier.
- Keller M. D., Selvin R. C., Claus W. & Guillard R. R. L., 1987. Media for the culture of oceanic ultraphytoplankton. *Journal of Phycology* 23:633-638.
- Kranz S. A., Sültemeyer D., Richter K. U. & Rost B., 2009. Carbon acquisition in *Trichodesmium*: diurnal variation and effect of pCO<sub>2</sub>. *Limnology and Oceanography* 54:548-559.
- Lakeman M. B., von Dassow P. & Cattolico A., 2009. The strain concept in phytoplankton ecology. *Harmful Algae* 8:746-758.
- Landry M. R., Kirshtein J. & Constantinou J., 1995. A refined dilution technique for measuring the community grazing impact of microzooplankton, with experimental test in the central equatorial Pacific. *Marine Ecology Progress Series* 120:53-63.
- Langer G., Nehrke G., Probert I., Ly J. & Ziveri P., 2009. Strain-specific responses of *Emiliania huxleyi* to changing seawater carbonate chemistry. *Biogeosciences* 6:2637-2646.
- Leonardos N. & Geider R. J., 2005. Elemental and biochemical composition of *Rhinosomonas reticulata* (Cryptophyta) in relation to light and nitrate-to-phosphate supply ratios. *Journal of Phycology* 41:567-576.
- Martin J. H. & Fitzwater S. E., 1988. Iron deficiency limits phytoplankton growth in the north-east Pacific subarctic. *Nature* 331:341-343.
- Monod J., 1950. La technique de culture continue théorie et applications. *Annales de l'Institut Pasteur* 79:390-410.
- Morel F. M. M., Rueter U. J. G., Anderson D. M. & Guillard R. R. L., 1979. Aquil: a chemically defined phytoplankton culture medium for trace metal studies. *Journal of Phycology* 15:135-141.

- Mullin M. M., Sloan P. R. & Eppley R. W., 1966. Relationship between carbon content, cell volume, and area in phytoplankton. *Limnology and Oceanography* 11:307-311.
- Novick A. & Szilard L., 1950. Description of the chemostat. *Science* 112:715-716.
- Paasche E., 2001. A review of the coccolithophorid *Emiliana huxleyi* (Prymnesiophyceae), with particular reference to growth, coccolith formation, and calcification-photosynthesis interactions. *Phycologia* 40:503-529.
- Price N. M., Harrison G. I., Hering J. G., Hudson R. J., Nirel P. M. V., Palenik B. & Morel F. M. M., 1988. Preparation and chemistry of the artificial algal culture medium Aquil. *Biological Oceanography* 6:443-461.
- Rost B., Zondervan I. & Wolf-Gladrow D., 2008. Sensitivity of phytoplankton to future changes in ocean carbonate chemistry: current knowledge, contradictions and research directions. *Marine Ecology Progress Series* 373:227-237.
- Rost B., Riebesell U. & Sültemeyer D., 2006. Carbon acquisition of marine phytoplankton: effect of photoperiod length. *Limnology and Oceanography* 51:12-20.
- Ryther J. H. & Dunstan W. M., 1971. Nitrogen, phosphorus, and eutrophication in the coastal marine environment. *Science* 171:1008-1013.
- Schulz K. G., Barcelos e Ramos J., Zeebe R. E. & Riebesell U., 2009. CO<sub>2</sub> perturbation experiments: similarities and differences between dissolved inorganic carbon and total alkalinity manipulations. *Biogeosciences* 6:2145-2153.
- Sciandra A., Harlay J., Lefèvre D., Lemée R., Rimmelin P., Denis M. & Gattuso J.-P., 2003. Response of coccolithophorid *Emiliana huxleyi* to elevated partial pressure of CO<sub>2</sub> under nitrogen limitation. *Marine Ecology Progress Series* 261:111-122.
- Sommer U., 1985. Comparison between steady state and non-steady state competition: experiments with natural phytoplankton. *Limnology and Oceanography* 30:335-346.
- Sunda W. G. & Huntsman S. A., 1995. Cobalt and zinc interreplacement in marine phytoplankton: biological and geochemical implications. *Limnology and Oceanography* 40:1404-1417.
- Tortell P. D., DiTullio G. R., Sigman D. M. & Morel F. M. M., 2002. CO<sub>2</sub> effects on taxonomic composition and nutrient utilization in an Equatorial Pacific phytoplankton assemblage. *Marine Ecology Progress Series* 236:37-43.
- Tortell P. D., Payne C. D., Li Y. Y., Trimborn S., Rost B., Smith W. O., Riesselman C., Dunbar R. B., Sedwick P. & DiTullio G. R., 2008. CO<sub>2</sub> sensitivity of Southern Ocean phytoplankton. *Geophysical Research Letters* 35, L04605. doi:10.1029/2007GL032583.
- Van Bleijswijk J. D. L., Kempers R. S., Veldhuis M. J. & Westbroek P., 1994. Cell and growth characteristics of types A and B of *Emiliana huxleyi* (Prymnesiophyceae) as determined by flow cytometry and chemical analyses. *Journal of Phycology* 30:230-241.
- Waterbury J. B., Watson S. W., Valois F. W. & Franks D. G., 1986. Biological and ecological characterization of the marine unicellular cyanobacterium *Synechococcus*. In: Platt T. & Li W. K. I. (Eds.), *Photosynthetic picoplankton*, pp. 71-120. Ottawa: Department of Fisheries and Oceans.
- Zondervan I., Rost B. & Riebesell U., 2002. Effect of CO<sub>2</sub> concentration on the PIC/POC ratio in the coccolithophore *Emiliana huxleyi* grown under light-limiting conditions and different daylengths. *Journal of Experimental Marine Biology and Ecology* 272:55-70.



### 6 Pelagic mesocosms

Ulf Riebesell<sup>1</sup>, Kitack Lee<sup>2</sup> and Jens C. Nejstgaard<sup>3</sup>

<sup>1</sup>Leibniz Institute of Marine Sciences (IFM-GEOMAR), Germany

<sup>2</sup>Pohang University of Science and Technology, South Korea

<sup>3</sup>Uni Environment, Research AS, Norway

#### 6.1 Introduction

One of the greatest challenges in understanding and forecasting the consequences of ocean acidification is the scaling of biotic responses at the cellular and organism level to the community and ecosystem level, and their parameterisation in ecosystem and biogeochemical models of the global ocean. Here mesocosms, experimental enclosures designed to approximate natural conditions, and in which environmental factors can be manipulated, provide a powerful tool to link between small-scale single species laboratory experiments and observational and correlative approaches applied in field surveys. A mesocosm study has the advantage over standard laboratory tests in that it maintains a natural community under close to natural, self-sustaining conditions, taking into account relevant aspects from “the real world” such as indirect effects, biological compensation and recovery, and ecosystem resilience. The mesocosm approach is therefore often considered the experimental ecosystem closest to the real world, without losing the advantage of reliable reference conditions and replication. By integrating over multiple species sensitivities and indirect effects up or down the food web, the responses obtained from mesocosm studies can be used to parameterise ocean acidification sensitivities in ecosystem and biogeochemical models.

As stated by Parsons (1982): “The main advantages ... unique to enclosed ecosystems are:

1. *The ability to study the population dynamics of two or more trophic levels for a protracted period of time.* This includes both biological studies regarding species dynamics as well as chemical studies towards achieving a mass balance for the distribution of certain elements in the water column.
2. *The ability to manipulate the environment of the water column either by natural means, such as physical upwelling, or by unnatural means, such as by the introduction of a pollutant.*”

Later mesocosm studies highlighted a third advantage that relates to the broad spectrum of processes captured in mesocosm enclosures, namely:

3. *The ability of bringing together scientists from a variety of disciplines, ranging from for example molecular and cell biology, physiology, marine ecology and biogeochemistry to marine and atmospheric chemistry and physical oceanography.* Combining a broad spectrum of disciplines in a single study offers the unique opportunity to study interactions of ecosystem dynamics and biogeochemical processes and track the consequences of ocean acidification *sensitivities* through the enclosed system (e.g. Heimdal *et al.*, 1994; Riebesell *et al.*, 2008a).

Although the first mesocosm experiment was reported in 1939 (Pettersen *et al.*, 1939), it was not until the 1960s and 1970s that studies in larger sized enclosures grew popular (Parsons, 1981; Banse, 1982). Over the past four decades, mesocosm studies have been successfully used for a wide range of applications and have provided a wealth of information on trophic interactions and biogeochemical cycling of aquatic ecosystem in lakes (Sanders, 1985; Gardner *et al.*, 2001), marine systems (Lalli, 1990; Oviatt, 1994) as well as in ecological risk assessment (Boyle & Fairchild, 1997). Effects of acidification on aquatic ecosystems were first studied in freshwater systems (Almer *et al.*, 1974; Schindler *et al.*, 1985; Schindler, 1988), where mesocosm studies on plankton, periphyton and metals gave results that were similar to those observed in whole-lake experiments (Schindler, 1980; Müller, 1980). Recently, a series of multinational mesocosm experiments were conducted to examine the effects of ocean acidification on

## Part 2: Experimental design of perturbation experiments

marine pelagic ecosystems (Delille *et al.*, 2005; Engel *et al.*, 2005; Kim *et al.*, 2006; Riebesell *et al.*, 2008a) with mesocosms moored in sheltered bays and free-floating in open waters (Figure 6.1). Results from these experiments highlighted the sensitivity of key components of the pelagic ecosystem to ocean acidification and revealed associated biogeochemical feedback processes (Riebesell *et al.*, 2008b).

It needs to be acknowledged, however, that artefacts, like wall growth, and constraints of enclosures have to be considered when extrapolating mesocosm results to natural systems (Pilson & Nixon, 1980; Brockmann, 1990; Petersen *et al.*, 1998). Enclosures of all kinds are inherently limited in their ability to include higher trophic levels, and to approximate water column structure and advective processes occurring in nature (Menzel & Steele, 1978; Carpenter, 1996). Enclosure effects may also influence food web dynamics to varying

**Figure 6.1** Mesocosm studies in ocean acidification research - *upper left*: PeECE III study in the Espengrend Marine Biological Station, Bergen, Norway (Riebesell *et al.*, 2008a); *upper right*: mesocosm facility at Jangmok on the southern coast of Korea (Kim *et al.*, 2008); *lower panel*: free-floating mesocosms deployed in the Baltic Sea (Riebesell *et al.*, unpubl.).



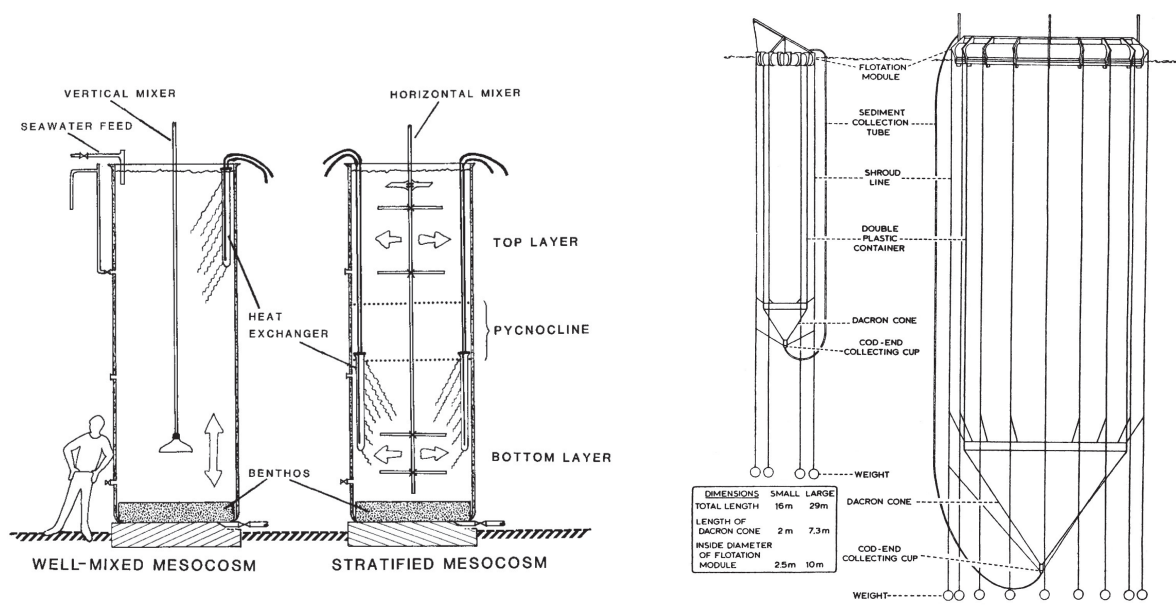
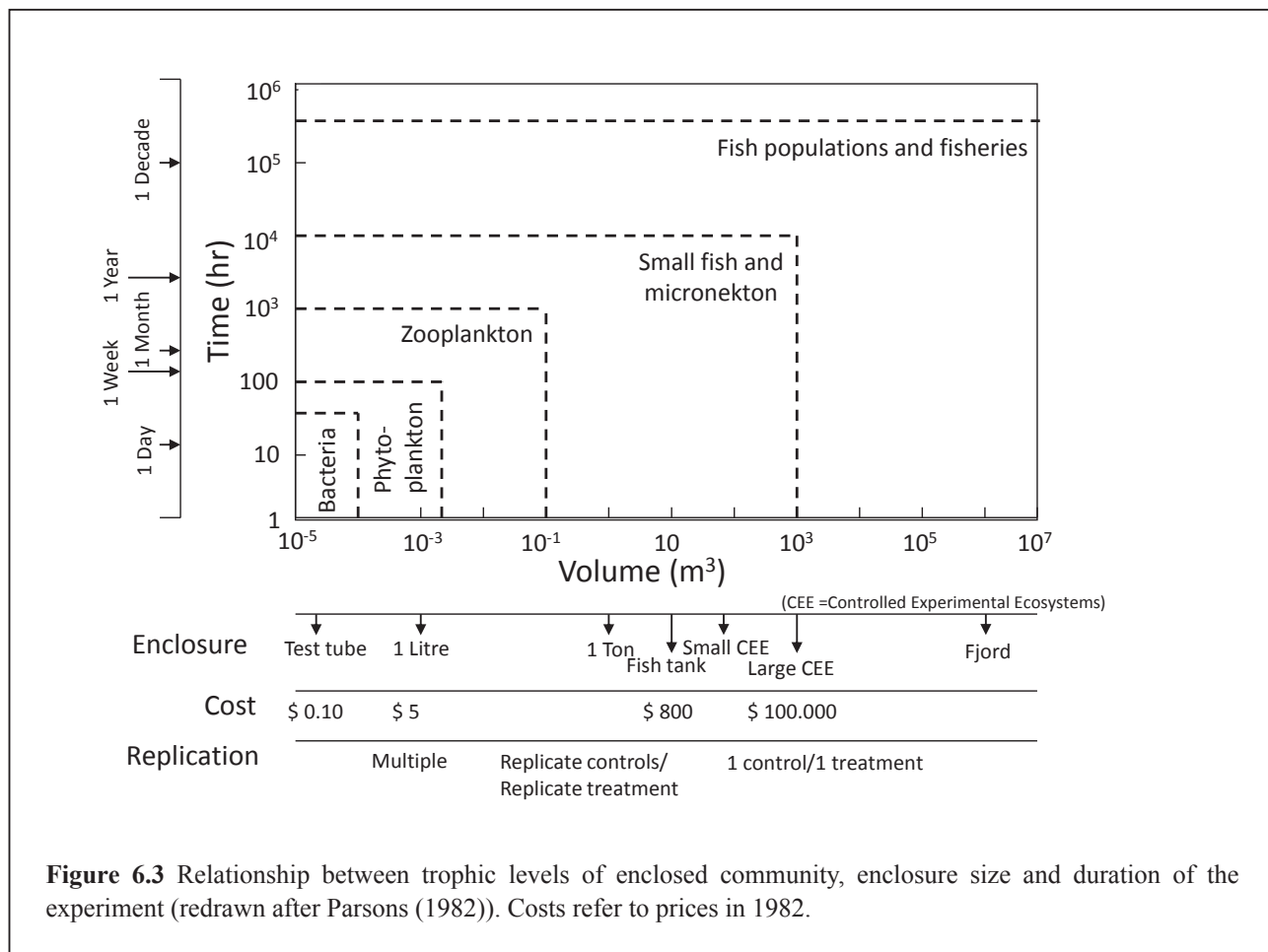

**Figure 6.2** Examples of two basic designs of mesocosm enclosures - left: MERL (Marine Ecosystem Research Laboratory) mesocosms at the University of Rhode Island, USA, with two different mixing schemes (left – plunger; right – rotating paddle, enabling a stratified water column); diameter: 1.83 m, height: 5.49 m, volume: 13.1 m<sup>3</sup>; from Donaghay & Klos (1985); right: flexible-wall *in situ* enclosures with floatation rings at the surface, used in CEPEX (Controlled Ecosystem Pollution Experiment) studies in Saanich Inlet, BC, Canada, in the late 1970s (Menzel D. W. & Case J., 1977. Concept and design: controlled ecosystem pollution experiment. *Bulletin of Marine Science* 27:1-7.).

degrees, creating trophic interactions that can differ with mesocosm dimension and which may deviate from those of the natural system intended to be mimicked (Kuiper *et al.*, 1983; Stephenson *et al.*, 1984; French & Watts, 1989). Despite these difficulties and the intense debate they have spurred over the past decades (e.g. Drenner & Mazumber, 1999), mesocosm enclosure studies still remain the most generally applicable means to experimentally manipulate and repeatedly sample multi-trophic planktonic communities (Greece *et al.*, 1980) and thus provide an essential link between small-scale experiments on individual organisms and observational approaches in field surveys and natural high-CO<sub>2</sub> environments. This link becomes indispensable when trying to investigate organism and population responses to ocean acidification at the ecosystem level and to parameterise them to be included in marine ecosystem and biogeochemical models.

## 6.2 Approaches and methodologies

Although the basic approach of mesocosm studies is straightforward and uniform, i.e. enclosing a body of water and studying the processes of interest in it over an extended period of time, the specifics of implementing a mesocosm experiment are often very different. This relates to aspects such as materials, design and location of the enclosures, for example land-based solid structures versus *in situ* flexible-wall enclosures (Figure 6.2), as well as the procedures used to fill, manipulate, mix and sample the mesocosms. Enclosure dimensions range from <1 m<sup>3</sup> (e.g. Berg *et al.*, 1999) to 1700 m<sup>3</sup> (Grice *et al.*, 1977; Menzel & Case, 1977). For practical purposes, experimental enclosures are subdivided into the following size classes according to enclosure volume: microcosms (<1 m<sup>3</sup>), mesocosms (1 to 1000 m<sup>3</sup>), macrocosms (>1000 m<sup>3</sup>) (SCOR Working Group 85, 2<sup>nd</sup> Report, 1991). We note that size categories may differ for benthic mesocosms.



**Figure 6.3** Relationship between trophic levels of enclosed community, enclosure size and duration of the experiment (redrawn after Parsons (1982)). Costs refer to prices in 1982.

### 6.2.1 Choice of mesocosm dimensions and duration of the experiment

There is an extensive body of literature on scaling relations in experimental ecology (e.g. Gardner *et al.*, 2001), highlighting the problems involved in extrapolating results from isolated, truncated experimental ecosystems to the “real” world. The choice of mesocosm dimensions and duration of the experiment both depend on the type of the enclosed community and the complexity of the food web, the generation times of its various components, the ecological and biogeochemical processes under consideration and the rate of fouling on the walls. The relationship between the enclosed community, the mesocosm size and the duration of the experiment was depicted in an instructive sketch by Parsons (1982) (Figure 6.3). Experiments with marine plankton communities in large (Takahashi *et al.*, 1975: 68 m<sup>3</sup>) and relatively small enclosures (Brockman *et al.*, 1977: 3 to 4 m<sup>3</sup>; Kuiper, 1977: 1.5 m<sup>3</sup>) showed that the development of bacteria, phytoplankton and zooplankton replicated sufficiently for periods of up to 4 to 8 weeks; hence the effects of pollutants can be detected by comparison with those observed in the non-polluted control. Based on a literature review on the use of field enclosures in freshwater and marine systems, Sanders (1985) assessed how accurately enclosures mimic ecological conditions and process rates occurring in adjacent habitats. Results concerning the potential ecological effects and fate of pollutants indicate that perturbation studies using field enclosures can provide defensible data at the population and community levels over time periods of several months and spatial scales of tens of meters. The degree of ecological realism that can be achieved, however, is variable. Chronic effects of some pollutants may be difficult to separate from nonspecific effects due to enclosure. Sanders (1985) concluded that determination of cause/effect pathways for observed toxicant impacts generally will require supplemental laboratory studies.

Dimension effects of enclosures on biological processes in pelagic systems have been investigated by various authors (e.g. Kuiper *et al.*, 1983; Stephenson *et al.*, 1984; Beyers & Odum, 1993; Berg *et al.*, 1999). When comparing

enclosures ranging in depth from 3 to 40 m and containing 1.5 to 30 m<sup>3</sup> of water, Kuiper *et al.* (1983) found that phytoplankton development in the upper mixed layer of the larger enclosures was very similar to that in the smaller ones. In contrast, bacterial numbers increased faster in small compared to large enclosures, probably because of closer contact with sedimented substrates. Copepod populations suffered high mortalities particularly in small bags. Beyers & Odum (1993) report that the smaller the size of the experimental units, the greater the deviations from the ecosystem responses. For instance, Kroer & Coffin (1992) show that rates of microbial processes are consistently reduced in microcosms as a result of disruption of critical processes, and Marrasé *et al.* (1992) report effects of the size of the experimental units on estimates of grazing rates on bacterioplankton. Further evidence of the difficulties in extrapolating experimental results derives from the observation that inferences drawn from similar experiments at different experimental scales (i.e. bottles to bags) are often inconsistent (Pace & Cole, 1994). Bergét *et al.* (1999) showed that differences in mesocosm geometry can lead to the development of different plankton assemblages. The ratio of light-receiving surface area to water column volume ( $A_s:V$ ) was shown to control both the rate of NO<sub>3</sub><sup>-</sup> consumption and gross primary productivity. The attenuation of water column irradiance was positively correlated with the wall area to volume ratio ( $A_w:V$ ) and notably greater microalgal biomass developed on the walls in systems with a high  $A_w:V$  ratio.

Petersen *et al.* (1999) conducted a literature review to assess implicit scaling choices made in the design of mesocosm studies for 360 experiments reported in the literature. They found that overall mesocosm experiments had a median duration of 49 d and a median volume of 1.7 m<sup>3</sup>, with number of replicates and treatments decreasing with increasing size. Volume and duration varied by habitat type, experimental treatment, number of trophic levels included, and the response variable under investigation. For improved mesocosm design and for the systematic extrapolation of information from experimental ecosystems to nature, Petersen *et al.* (1999) stress the need for both “scale-sensitive” experiments, that explicitly consider scale in design and interpretation of results, and “multi-scale” experiments that manipulate temporal and spatial attributes in order to test specific hypotheses

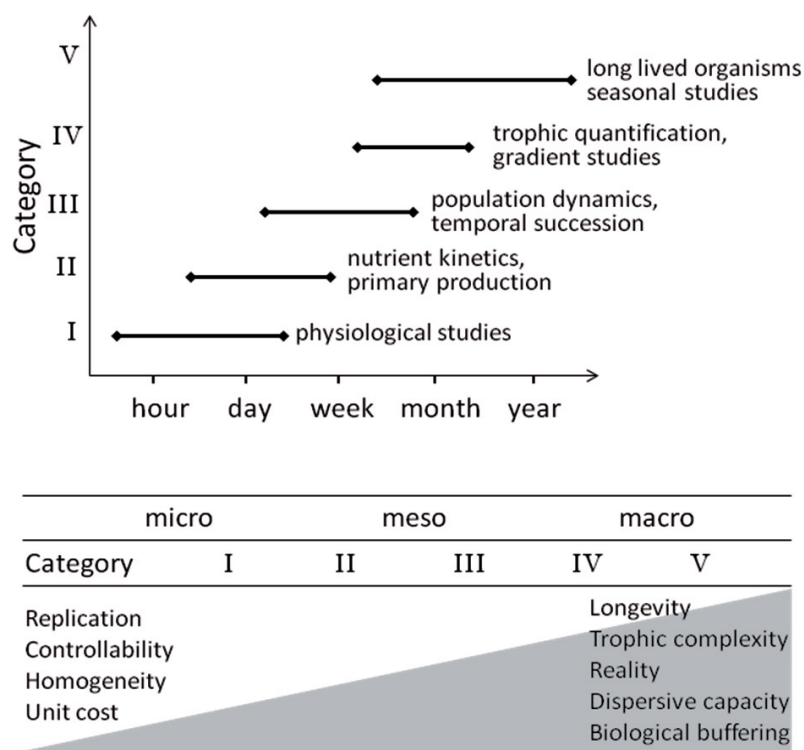

**Figure 6.4** Size categories of ecosystem enclosures and duration of experiments in relation to relevant biological processes (SCOR Working Group 85, 2<sup>nd</sup> Report, 1991).

regarding the ecological impact of modification in scale. As a rule of thumb, to maximise the number of replicates and treatments and to keep the costs of running an experiment reasonable, enclosures should be as small as possible without compromising their representativeness of the “real world” (Figure 6.4, Table 6.1). Obviously, it is often not clear which aspects of representativeness are lost with decreasing enclosure size.

**Table 6.1** Scaling of ecosystem enclosures and suitable ranges of application.

	Volume (m <sup>3</sup> )	Number of units	Duration	Range of application
I-II	1-10	Multiple	Days to weeks	Most suitable for rigorous quantitative hypothesis testing using parametric statistics, best operated for process studies on communities up to the level of heterotrophic protists.
II-III	10-100	<10	Weeks to months	Suitable for quantitative hypothesis testing and longer term, time-dependent observations; ideal for process studies on communities up to the level of micro- and mesozooplankton.
III-IV	100-1000	<5	Weeks to months	Ideal for studying multitrophic interactions including tertiary trophic level, difficult to carry out quantitative hypothesis testing; ideal for gradient studies and trophic quantification.
IV-V	>1000	1 or 2	Months to a year	Ideal for growth-mortality studies of larger, less abundant organisms; data evaluated through time-series analysis.

### 6.2.2 Filling of the enclosure

Ideally, filling of the enclosures should be done with minimum disturbance of the enclosed community. Filling by pumps may, depending on the type of pump and pumping rate, damage some of the larger organisms (e.g. zooplankton) and may completely destroy more fragile species (e.g. gelatinous zooplankton), although at least some gelatinous plankton and even small fish have been found to pass undamaged (J. Nejstgaard, unpubl.) when using specially designed centrifugal plankton pumps as in e.g. Nejstgaard *et al.* (2006). In the land-based Marine Ecosystem Research Laboratory (MERL) system, an air-driven or electricity-driven diaphragm pump caused minimal damage to sensitive organisms during fill operations or exchange schedules (Pilson & Nixon, 1980). While in land-based mesocosms the use of a pumping system may be unavoidable, *in situ* mesocosm deployments offer the opportunity to enclose a body of water by unfolding the mesocosm bag around it, e.g. by lowering or lifting the bag like a curtain (Menzel & Case, 1977), thereby avoiding any direct damage to the enclosed community. This may also retain the physical and chemical structure of the water column, such as thermohaline stratification or vertical gradients in nutrient concentrations. In order to check for possible disturbances during mesocosm filling and to be able to consider their effects in the interpretation of the experimental results, the enclosed community should be carefully examined and compared to the source water community before the start of the experiment. The choice of filling method may also depend on the ecosystem studied; it is likely that systems with stable, stratified water columns have organisms and structures that are much more prone to severe damage from pumping, compared to ecosystems in, for example, mixed swell zones that are more adapted to continuously high turbulence.

An important consideration may be whether to work with open or closed systems. Flushing of the enclosed water body may be preferential to ensure continued inflow of nutrients and new recruits or to maintain the composition of the enclosed community closer to that in the natural system. Closed systems are beneficial when the study objectives include budget estimates, and in cases where the enclosures contain organisms that may concentrate or dilute as a result of migratory and/or escape behaviour. For *in situ* mesocosms it may appear tempting to work with enclosures open at the bottom, for example to allow migration of zooplankton in and out of the system. However, recent tests with floating marine mesocosms show that even when free to drift with the water currents, the characteristics of the water surrounding the mesocosms can change within a matter of hours. Where the mesocosms had entered waters of lower density, the enclosed water was rapidly exchanged through sinking out of the mesocosm bags (U. Riebesell, unpubl.).

### 6.2.3 Mixing

Enclosing a body of water always alters the mixing regime. Changes in the hydrodynamics of enclosed water bodies often lead to observed differences between experimental ecosystems and the natural environment. In fact, there are at least four inter-related areas in which turbulence affects small-scale ecosystem processes: predator-prey interactions, particle aggregation and disaggregation, small-scale patchiness, and species-specific growth inhibition. In a comprehensive review on the role of turbulent mixing in aquatic ecosystems and approaches to mimic natural turbulence in enclosed experimental ecosystems, Sanford (1997) argues that turbulent mixing is equal in importance to light, temperature, salinity and nutrient concentrations.

Mixing in enclosures can be separated conceptually into large-scale flow and small-scale shear (Sanford, 1997). In general, experimental ecosystem enclosures should have sufficient flow to prevent localised stagnation and enough shear to mimic the range of natural turbulent energy dissipation rates. Simulating natural small-scale turbulence and its effects in experimental enclosures is relatively straightforward (Peters & Gross, 1994). Small-scale turbulence is approximately isotropic and homogeneous, i.e. statistically independent of direction and spatially uniform (Landahl & Mollo-Christensen, 1986) and does not depend on the turbulence generation mechanism. In contrast, generation of realistic large-scale turbulence in experimental ecosystem enclosures can be a challenge, especially if a realistic turbulent cascade also is of interest (Sanford, 1997). Problems arise because characteristic length-scales of large eddies in nature are typically larger than the dimensions of experimental enclosures.

Various approaches have been applied to generate turbulent mixing in experimental ecosystems, ranging from vertically oscillating plungers (Nixon *et al.*, 1980; Donaghay & Klos, 1985), airlifts (Williams & Egge, 1998; Engel *et al.*, 2005; Kim *et al.*, 2008), rotating paddles (Donaghay & Klos, 1985; Prins *et al.*, 1994), impellers (Petersen *et al.*, 1998; Sommer *et al.*, 2006), oscillating grids (Howarth *et al.*, 1993), bubbling (Eppley *et al.*, 1978; Sonntag & Parsons, 1979), combined oscillating grids and bubbling (Svensen *et al.*, 2001), and pumping (Figure 6.5). Petersen *et al.* (1998) tested the effect of mixing intensity on a plankton ecosystem in 1 m<sup>3</sup> mesocosms at mixing rates corresponding to calm oceanic surface waters, coastal water conditions and levels encountered at tidal fronts. Mixing had a significant negative effect on copepod and gelatinous zooplankton abundance (see also Oviatt, 1981) and also altered the timing of peak copepod densities. Chlorophylla dynamics and phytoplankton group composition exhibited modest differences among mixing treatments. Mixing had negligible effects on nutrient concentrations and on community and whole-system productivity and respiration (e.g. Svensen *et al.*, 2001). For a detailed assessment of the different approaches and recommendations on implementing and quantifying turbulent mixing in experimental ecosystems, see Sanford (1997). Flexible-wall *in situ* mesocosms, such as the large CEPEX (Controlled Ecosystem Pollution Experiment) enclosures (Figure 6.2), are often not mixed other than by naturally induced motion of the walls and convective overturning generated by night-time cooling. Steele *et al.* (1977) estimated vertical turbulent diffusivities of approximately 0.1 cm<sup>2</sup> s<sup>-1</sup> in the CEPEX enclosures, about an order of magnitude smaller than turbulent diffusivity in the natural surface layer. Reduced mixing caused CEPEX enclosures to become artificially stratified, resulting in reduced upward nutrient flux (Takahashi & Whitney, 1977) and larger phytoplankton to settle out rapidly after initiation of the experiments (Eppley *et al.* 1978). Absence of large-scale mixing almost certainly meant little turbulent energy at small scales, which likely affected trophic interactions within

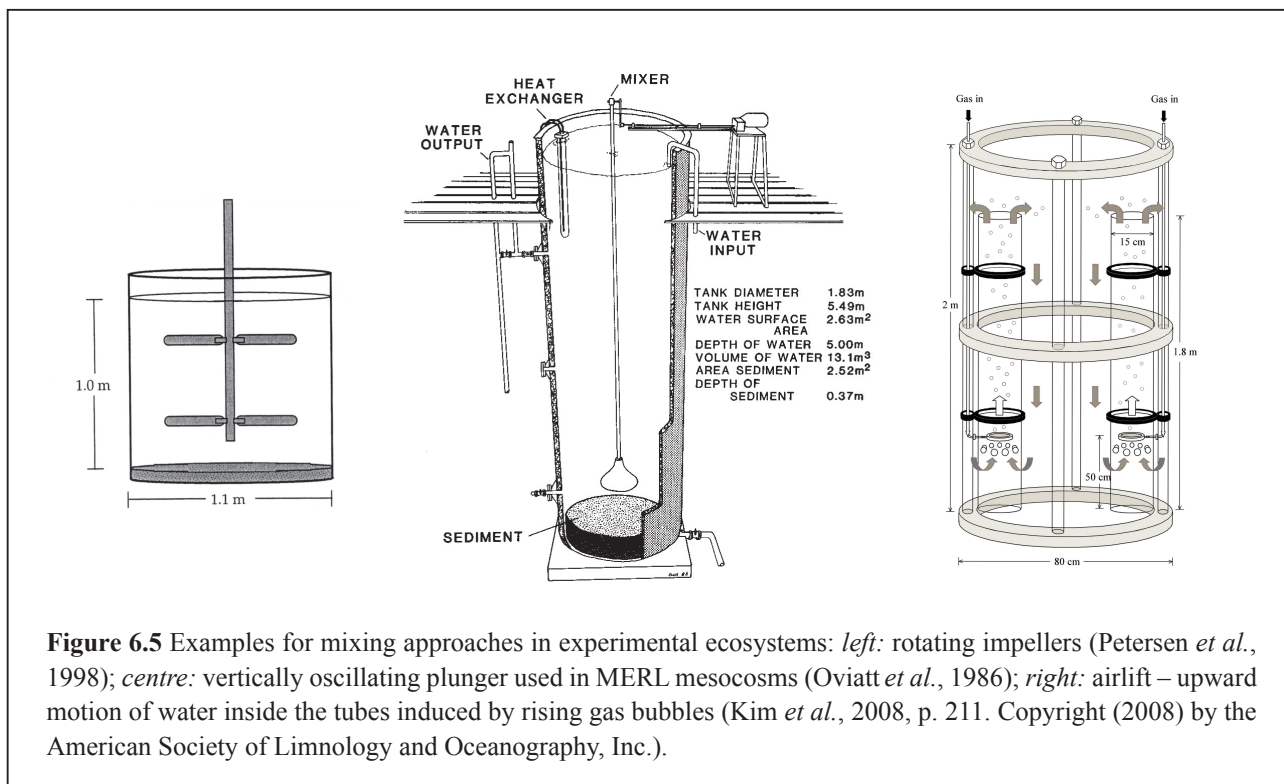

the enclosures as well. Brief daily mixing by bubbling was sufficient to re-establish a plankton community closer to that in the unenclosed environment (Eppley *et al.*, 1978; Sonntag & Parsons, 1979), but the temporal pattern and intensity of mixing were not natural. Small flexible-wall enclosures narrower than the wavelength of prevailing waves seem to be better mixed (Gust, 1977; Takahashi & Whitney, 1977), but may still be under-mixed relative to the external water (Harada *et al.*, 1999). However, more recently a combination of vertical mixing by bubbling and turbulence regulation by oscillating horizontal grids in flexible-wall mesocosms created turbulence within the range of natural systems (Svensen *et al.*, 2001; Nerheim *et al.*, 2002). Moreover, enhanced rates of vertical mixing in flexible-wall *in situ* mesocosms relative to the external water can result from wave energy broken by the tube wall and imparted to the structure itself, causing bobbing and rocking of the floatation ring (Hesslein & Quay, 1973). Future experiments with flexible-wall mesocosms should make an effort to better mimic the turbulence of the natural systems of interest. See for example Stiansen & Sundby (2001) and Nerheim *et al.* (2002) for more recent successful constructions of turbulence generators and measurements in mesocosms.

Nevertheless, it is unreasonable to expect that any single mixing design for an enclosed experimental ecosystem will reproduce all of the important characteristics of natural turbulence. It is important, however, to carefully consider the choice of mixing scheme and understand the potential consequences for the interpretation of the results. For all ecosystem enclosure experiments it is essential to characterise and report on the mixing configuration and turbulence characteristics (see Sanford (1997) for recommendations) and, wherever possible, conduct direct velocity measurements of turbulent mixing.

### 6.2.4 Replication

Due to the high cost and logistical effort involved in mesocosm experiments, the number of replicates and treatments by necessity will be relatively small. Moreover, the concept of a mesocosm as an experimental system which is comprised of several interacting trophic levels does not fit the strict statistical definition of a control. As stated by Gamble & Davies (1982): “Large-scale enclosure (mesocosm) experiments do not lend themselves to conventional methods of experimental design involving the use of inferential statistics. When considering design criteria for mesocosm experiments, it is therefore necessary to examine the rigour of the proposed replication, to make allowance



for inherent spatial and temporal heterogeneity, and to consider alternative experimental strategies.” Considering that most mesocosm experiments will have access to approximately 10 or less mesocosm units, there are basically two options for the experimental design (see also chapter 4 of this guide):

1. 2 to 4 treatments with a minimum of 3 replicates each, with data analysis based on ANOVA;
2. a gradient in perturbation levels ( $p(\text{CO}_2)$  or other carbonate system parameters relevant to the study objectives), using regression analysis for data evaluation.

It should be recognised that the degree of natural variation within control and treated mesocosms may often mask subtle treatment differences, which therefore will be extremely difficult to verify statistically. This should be kept in mind when interpreting the absence of a statistically significant treatment effect in a mesocosm study.

### 6.2.5 $\text{CO}_2$ control

In the experimental design of a  $\text{CO}_2$  perturbation experiment four aspects need to be considered: (1) Method of  $\text{CO}_2$  manipulation; (2) Time course of  $\text{CO}_2$  manipulation; (3) Control of carbonate chemistry during the experiment and (4) Control of  $p(\text{CO}_2)$  in closed headspace vs. open headspace with ambient  $p(\text{CO}_2)$ .

1. The four approaches for manipulating seawater carbonate chemistry:
  - a) addition of acid or base (e.g. HCl or NaOH)
  - b) aeration with  $\text{CO}_2$  enriched air or pure  $\text{CO}_2$  gas
  - c) addition of equimolar amounts of  $\text{NaHCO}_3$  and HCl or (or  $\text{Na}_2\text{CO}_3$  with double-molar amounts of HCl)
  - d) addition of  $\text{CO}_2$  saturated seawater

and their strength and weaknesses are described in detail in chapter 2. For most purposes, approaches (b) - (d) may be preferred over (a) because they better mimic ocean acidification (but see also Schulz *et al.*, 2009). For some research questions or due to technical constraints (e.g. pH stat experiments), approach (a) may be more useful or practical. For each approach it should be assured that the same degree of physical agitation is applied to all mesocosms (e.g. controls are subjected to aeration of the same rate and duration as treatments).

2. When using approaches (a), (c), and (d),  $\text{CO}_2$  enrichment can be achieved rapidly in one step, in several smaller steps or gradually over an extended period of time (Figure 6.6). Approach (b) generates a more or less gradual change in carbonate chemistry, depending on the difference in  $\text{CO}_2$  partial pressure between the  $\text{CO}_2$ -enriched air and the mesocosm enclosure, aeration rate and mesocosm volume. While a step-wise or gradual change in carbonate chemistry may be least disturbing to the enclosed community and would therefore be preferable, due to time constraints of the experiment this may not always be feasible. With little information on the biological impacts of rapid versus gradual changes in carbonate chemistry, it is presently not possible to give a strong recommendation on this issue.
3. Maintaining carbonate chemistry constant at target levels during the course of the experiment requires compensating for possible changes due to biological activity (photosynthesis, respiration, calcification, carbonate dissolution) or, in the case of an open system, air-sea gas exchange. In the absence of calcification and carbonate dissolution (i.e. at constant alkalinity), carbonate chemistry can be kept nearly stable by aeration with air at target  $p(\text{CO}_2)$  level (small changes in alkalinity result from nitrate ( $+A_T$ ) or ammonium uptake ( $-A_T$ ) due to primary production). In the presence of calcification or carbonate dissolution, changes in both alkalinity and DIC need to be compensated for.



**Figure 6.6** Possible time courses for  $\text{CO}_2$  manipulation.

Technically, this is going to be quite challenging in large volumes of water, particularly if the ratio of calcification (carbonate dissolution) to photosynthesis (respiration) varies over time. Alternatively, carbonate chemistry can be allowed to freely drift as would naturally occur for example during the course of a phytoplankton bloom. Due to the lower buffer capacity of acidified seawater, the drift in  $p(\text{CO}_2)$  and pH in response to biological activity will be stronger in  $\text{CO}_2$  enriched treatments (Delille *et al.*, 2005; Riebesell *et al.*, 2007).

4. A better simulation of  $\text{CO}_2$  air/sea gas exchange in different  $\text{CO}_2$  treatments can be achieved by controlling  $p(\text{CO}_2)$  in a closed headspace overlying the mesocosm water column. The significance of a  $p(\text{CO}_2)$  controlled headspace increases with decreasing mesocosm volume and with increasing sea surface area to enclosure volume ratio. In large ( $>10 \text{ m}^3$ ) mesocosms and with experiments running for only a few weeks, effects of biological activities on carbonate chemistry will generally be much stronger than  $\text{CO}_2$  air/sea gas exchange across the air/water interphase. The choice for a  $\text{CO}_2$  controlled headspace therefore depends on the mesocosm surface area to volume ratio, the  $p(\text{CO}_2)$  gradient across the air/water interphase, the duration of the experiment and on a study's scientific question.

### 6.3 Strengths and weaknesses

The strengths of mesocosm enclosure experiment are that (1) populations of at least three trophic levels can be enclosed in naturally occurring proportions and in a self-sustaining manner over a long experimental period; (2) the same populations can be sampled repeatedly over time and (3) replicate enclosed populations can be experimentally manipulated. Further advantages of flexible-wall *in situ* enclosures are that a large volume of water and most of its associated organisms can be captured with minimal disturbance, incident light is more natural than in many other experimental ecosystems, and that temperature of enclosures follow the trend observed in the surrounding water. The large volume of water available for sampling in mesocosm experiments further offers the opportunity for multidisciplinary studies, generating extensive data sets and providing a high level of scientific integration and cross-disciplinary collaboration. Data sets of mesocosm enclosure experiments are of particular value to marine ecosystem and biogeochemical model parameterisations and evaluations.

Mesocosm enclosure experiments have a number of weaknesses, which both the experimentalists analysing and interpreting the data as well as the modelling community using mesocosm results should be aware of and consider in their work. These weaknesses include:

1. unnatural mixing regimes and turbulence level;
2. wall effects and growth of periphyton and other organisms on mesocosm walls;
3. the larger and therefore more expensive the enclosures become, the more difficult it is to run sufficient replicates and multiple treatments.

These limitations, and the fact that even in the largest pelagic mesocosms higher trophic levels and in particular strongly migratory organisms (e.g. euphausiids and fish) are excluded, complicate the extrapolation of mesocosm results to the "real world". Because the duration of pelagic enclosure experiments is restricted to time scales of weeks to months due to the increased influence of wall effects and gradual deviation of the enclosed communities from the natural system, responses of organisms with longer (e.g. annual) life cycles and associated food-web effects may not be adequately represented in mesocosm studies.

### 6.4 Potential pitfalls and suggestions for improvements

There are a number of pitfalls which can obscure the interpretation of mesocosm results, but for the most part can be avoided or minimised in carefully designed and executed enclosure experiments. These include:

- initial conditions not identical across all enclosures;
- deviation of enclosed ecosystem from the "real world" due to unnatural mixing scheme;

- differences in environmental conditions between enclosures;
- non-representative sampling;
- perturbation other than the experimental treatment;
- wall growth.

#### 6.4.1 Initial conditions

Small differences in the initial composition of the enclosed community can cause significant deviation in the development of the pelagic community with associated effects on trophic interactions and elemental cycling during the course of the experiment. Great care should therefore be taken to minimise differences in the starting community. One way to minimise differences in initial seed populations is to distribute the water between the mesocosms by filling in a sequential or staggered fashion (e.g. Nejtgaard *et al.*, 2006), or using a system that evenly distributes the water between all enclosures simultaneously as done in Svensen *et al.* (2001) and Sommer *et al.* (2006). Another way is to use a flow-through system replacing for example 5 to 20% of the enclosure volume per day (see e.g. Nejtgaard *et al.*, 1997, 2006). This allows for continuous re-introduction of new species and keeps the system in the enclosures more similar to the surrounding water (for further discussion see Williams & Egge, 1998).

#### 6.4.2 Mixing

Unnatural mixing can affect the composition and succession of the enclosed community and can influence trophic interactions and elemental fluxes. It is unreasonable to expect artificial mixing of the enclosed water to fully mimic natural turbulence, although the overall dissipation energy may well fall in the range of natural conditions using flexible-wall mesocosms with air mixing (Svensen *et al.*, 2001). Rather, mesocosm researchers should weigh the goals of their experiments against the costs of implementing a mixing scheme and the likely artefacts of design compromises. Turbulent mixing conditions in ecosystem enclosures should be characterised before experiments begin, and conditions should be monitored during experiments if necessary. The mixing configuration and turbulence characteristics should be reported along with mesocosm results as suggested for example by Nerheim *et al.* (2002).

#### 6.4.3 Differences in environmental conditions

Significant deviation in enclosure development due to different environmental conditions can mask a treatment effect or generate a false treatment effect. A potential source for this could be differences in light conditions through shading of some enclosures, for example when a set of enclosures is not lined up properly in east-west direction to allow for equal exposure during the sun's daily cycle. To avoid effects of mesocosm positioning, enclosures should also be randomly assigned to experimental treatments (see Figure 6.7 for acceptable modes of interspersing the replicates; see also chapter 4 for further details).

#### 6.4.4 Sampling

In cases where the enclosed water is not sufficiently mixed to ensure suspended particles and organisms to be homogeneously distributed, discrete sampling at any given depth may result in large data variance and measurements which are not representative for the whole mesocosm (tested by Kimet *et al.*, 2008). Likewise, sampling at different times of the day can increase data variance due to vertical migration of larger plankton, especially mesozooplankton, and (synchronised) life cycles of some populations, such as e.g. the colony formation in *Phaeocystis pouchetii* (compare Nejtgaard *et al.* (2006) and Verity *et al.* (2007)). When mesocosms are continuously mixed (e.g. Williams & Egge, 1998; Nejtgaard *et al.*, 2006) the salinity, temperature and organisms smaller than mesozooplankton are often homogeneously distributed throughout the mixed water column. In such cases a single discrete sample may represent the entire water column for those parameters. However, it is recommended to initially test the homogeneity of the water column before using discrete samples, or better, use depth-integrated sampling over the entire water column to minimise possible vertical differences.

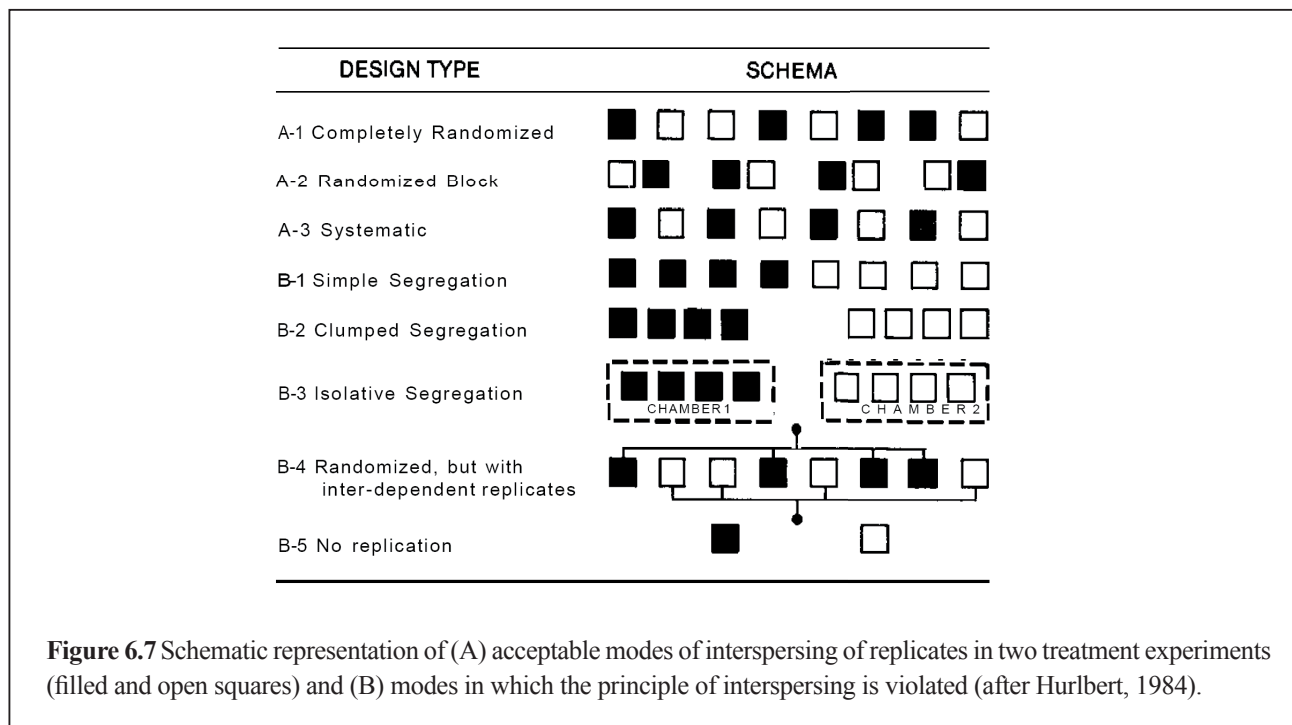

A vertically integrating sampling scheme can minimise the variation in sampling and decrease the need for multiple sampling in mesocosms which are not homogeneously mixed. This has been found to work well for dissolved and most particulate parameters in mesocosm studies with intended stratification and limited mixing in the upper surface layer (Engel *et al.*, 2005; Schulz *et al.*, 2008). However, larger organisms, such as copepods, may distribute themselves strongly along surfaces in mesocosms with little or moderate mixing (J. Nejstgaard, unpubl.) and may thus only be adequately quantified if sampled when emptying the whole mesocosm through a net at the termination of the experiment (as described in Nejstgaard *et al.*, 2001, 2006). Furthermore, larger zooplankton such as jellyfish may in any case be difficult to keep in conventional mesocosms as they may aggregate and be destroyed along the walls of the mesocosms (Martin, 2001).

### 6.4.5 Unintended perturbations

Perturbations other than the experimental manipulation may cause responses that mask possible treatment effects. For example, the absence of turbulent mixing or excessive mixing can cause shifts in the plankton community following its enclosure, which could override subtle treatment effects during a period of acclimation. Likewise, CO<sub>2</sub> manipulation through vigorous bubbling may disturb shear-sensitive components of the plankton community and can cause the aggregation of dissolved organic matter, causing foam accumulation at the surface. Inorganic nutrient addition can cause a major restructuring of the enclosed system, particularly if it consists of a recycling plankton community. During a transient phase, shifting of the community structure may disguise possible subtle treatment effects.

### 6.4.6 Wall growth

A common artefact in enclosure experiments is the occurrence of wall growth (Chen *et al.*, 1997). The problem increases with increasing surface area to volume ratio of the enclosure and duration of the experiment, to the extent that wall-associated processes can dominate over pelagic processes. Mixing schemes that cause large shear at the walls relative to the interior of an enclosure should be avoided because it reduces the transfer limitation for wall communities and thereby further stimulates wall growth. This is especially important in regions with naturally high fouling potential, for example by benthic diatoms, as observed in the coastal Northwest Pacific (T. Klinger, Univ. of Washington, pers. com.), while other areas such as in west Norwegian

fjords have shown very limited on-growth problems (J. Nejstgaard pers. obs). Although the growth of wall communities can be controlled by frequent wall cleaning (e.g. Brussard *et al.*, 2005), it should be noted that this may also introduce an unnaturally high accumulation of free bio-film/detritus in the water column and potentially create physical disturbance of the zooplankton. Thus, besides aiming at a maximal volume to surface ratio, it is advisable to investigate the natural fouling potential before designing a mesocosm experiment in a specific area and to monitor wall growth during the experiment.

## 6.5 Data reporting

Data reporting should include clear descriptions of:

1. The experimental design and protocols, including:
  - location of mesocosm deployment;
  - mesocosm materials and their chemical properties (e.g. gas and light permeability);
  - mesocosm dimensions;
  - mode of interspersed replicates;
  - approach used to fill the mesocosms;
  - mixing regime;
  - method of carbonate chemistry manipulation (see chapter 2 for guidelines);
  - strategy of carbonate chemistry manipulation (abrupt vs. step-wise vs. gradual);
  - other manipulations of the enclosed water column (such as nutrient additions, changes in temperature, salinity etc.);
  - sampling frequency, time and strategy (e.g. at discrete depths or on depth-integrated samples).
2. The environmental conditions at the start and during the course of the experiment, including:
  - salinity and temperature (with daily monitoring in vertical profiles in-and outside of the mesocosms) to determine water column structure and check for possible water exchange;
  - carbonate chemistry, with measurements of at least two parameters of the carbonate system (see chapter 1);
  - nutrient concentrations;
  - continuous recording of solar irradiance;
  - information on the light climate inside the mesocosms compared to the outside.
3. The plankton community at the start and during the course of the experiment, including:
  - detailed inventory of the enclosed biota in terms of standing stocks, composition and physiological state (e.g. Chl cell<sup>-1</sup>,  $F_v/F_m$ );
  - bulk measurements of biogenic material (e.g. POM, DOM, PIC, BSi);
  - chlorophyll fluorescence (with daily monitoring in vertical profiles);
  - if applicable, information on the exclusion or addition of selected components from/into the enclosures;
  - other optional parameters, depending on the research question and experimental setting;
  - development of the environmental conditions and plankton community in the waters surrounding the mesocosms;
  - rates of key biological processes (e.g. auto- and heterotrophic activities, calcification).

In order to check for identical start conditions in all mesocosms, a detailed analysis of relevant parameters should be conducted right after the filling of the mesocosms and before the first manipulation. Precision and

## Part 2: Experimental design of perturbation experiments

accuracy in measurements of the parameters of the CO<sub>2</sub> system and associated factors (e.g. temperature, salinity, nutrient concentrations) should be reported. In cases where derived data are reported, original data should be available as an appendix or online. The motivation for the choice of selected p(CO<sub>2</sub>) levels should be described (see chapter 2 for guidelines).

### 6.6 Recommendations for standards and guidelines

1. The mesocosm hardware should consist of inert materials, enclosures should be impermeable.
2. The size of the mesocosms and duration of the experiment should be appropriate for the enclosed community and the time scale of the investigated processes.
3. Filling of the enclosures should take place simultaneously in all mesocosms from a single reservoir to ensure high similarity in starting populations.
4. Perturbations other than the experimental treatment, including strong disturbances during enclosure filling and CO<sub>2</sub> manipulation, should be avoided.
5. A CO<sub>2</sub> controlled headspace is recommended for small enclosures and long experiments; the cover material should be transparent to the full spectrum of sunlight.
6. Mixing of the enclosed water should aim to simulate natural conditions; the mixing configuration and turbulence characteristics should be reported and, whenever possible, direct velocity measurements of turbulent mixing be conducted.
7. The composition of the enclosed community in all mesocosms should be carefully examined and compared prior to the experimental manipulation.
8. The distributions of organisms and particulate matter in enclosed water columns should be investigated for spatial heterogeneity prior to experimentation and sampling strategies adapted to reduce the error in estimating them.
9. When vertical mixing is incomplete or complete mixing is not intended in order to maintain a stratified water column, depth-integrated sampling is recommended.
10. In order to improve understanding of the underlying mechanisms of observed responses and to facilitate up-scaling of mesocosm results, ecosystem enclosure experiments should be closely integrated with laboratory experiments and modelling of ecosystem responses.
11. To fully exploit the potential of ecosystem enclosure experiments and to advance understanding of the complex interactions of mesocosm enclosures, a broad range of disciplines should be engaged.
12. To facilitate the transfer of knowledge gained from mesocosm experimentation and improve the comparability of mesocosm results from different facilities, a mesocosm network should be established.

### 6.7 References

- Almer B., Dickson W., Ekström C. & Hörnström E., 1974. Effects of acidification on Swedish lakes. *Ambio* 3:30-36.
- Banse K., 1982. Experimental marine ecosystem enclosures in an historical perspective. In: Grice D. & Reeve M. R. (Eds.), *Marine mesocosms: biological and chemical research in experimental ecosystems* pp. 11-24. New York: Springer-Verlag.
- Berg G. M., Glibert P. M. & Chen C. C., 1999. Dimension effects of enclosures on ecological processes in pelagic systems. *Limnology and Oceanography* 44:1331-1340.
- Beyers R. J. & Odum H. T., 1993. *Ecological microcosms*. 557 p. New York: Springer-Verlag.

- Boyle T. P. & Fairchild J. F., 1997. The role of mesocosm studies in ecological risk analysis *Ecological Applications* 7:1099-1102.
- Brockmann U., 1990. Pelagic mesocosms: II. Process studies. In: Lalli C. M. (Ed.) *Enclosed experimental marine ecosystems: a review and recommendations*, pp. 81–108. New York: Springer-Verlag.
- Brockmann U. H., Eberlein K., Hosumbek P., Trageser H., Maier-Reimer E., Schone H. K. & Junge H. D., 1977. The development of a natural plankton population in an outdoor tank with nutrient-poor sea water. 1. Phytoplankton succession. *Marine Biology* 43:1-17.
- Brussaard C. P. D., Kuipers B. & Veldhuis M. J. W., 2005. A mesocosm study of *Phaeocystis globosa* population dynamics: I. Regulatory role of viruses in bloom control. *Harmful Algae* 4:859-874.
- Carpenter S. R., 1996. Microcosm experiments have limited relevance for community and ecosystem ecology. *Ecology* 77:677-680.
- Chen C.-C., Petersen J. E. & Kemp W. M., 1997. Spatial and temporal scaling of periphyton growth on walls of estuarine mesocosms. *Marine Ecology Progress Series* 155:1-15.
- Delille B., Harlay J., Zondervan I., Jacquet S., Chou L., Wollast R., Bellerby R. G. J., Frankignoulle M., Borges A. V., Riebesell U. & Gattuso J.-P., 2005. Response of primary production and calcification to changes of pCO<sub>2</sub> during experimental blooms of the coccolithophorid *Emiliana huxleyi*. *Global Biogeochemical Cycles* 19, GB2023. doi:10.129/2004GB002318.
- Donaghay P. L. & Klos E., 1985. Physical, chemical and biological responses to simulated wind and tidal mixing in experimental marine ecosystems. *Marine Ecology Progress Series* 26:35-45.
- Drenner R. W. & Mazumder A., 1999. Microcosm experiments have limited relevance for community and ecosystem ecology: Comment. *Ecology* 80:1081-1085.
- Engel A., Zondervan I., Aerts K., Beaufort L., Benthien A., Chou L., Delille B., Gattuso J.-P., Harlay J., Heemann C., Hoffmann L., Jacquet S., Nejtgaard J., Pizay M.-D., Rochelle-Newall E., Schneider U., Terbreuggen A. & Riebesell U., 2005. Testing the direct effect of CO<sub>2</sub> concentration on a bloom the coccolithophorid *Emiliana huxleyi* in mesocosm experiments. *Limnology and Oceanography* 50:493-507.
- Eppley R. W., Koeller P. & Wallace G. T., 1978. Stirring influences the phytoplankton species composition within enclosed columns of coastal sea water. *Journal of Experimental Marine Biology and Ecology* 32:219-239.
- French R. H. & Watts R. J., 1989. Performance of in situ microcosms compared to actual reservoir behavior. *Journal of Environmental Engineering* 115:835-849.
- Gamble J. C. & Davies J. M., 1982. Application of enclosures to the study of marine pelagic systems. In: Grice G. D. & Reeve M. R. (Eds.), *Marine mesocosms*, pp. 25-48. New York: Springer-Verlag.
- Gardner R. H., Kemp M. W., Kennedy V. S. & Petersen J. E., (Eds.), 2001. *Scaling relations in experimental ecology*, 352 p. New York: Columbia University Press.
- Grice G. D., Harris R. P., Reeve M. R., Heinbokel J. F. & Davis C. O., 1980. Large-scale enclosed water-column ecosystems. An overview of foodweb I, the final CEPEX experiment. *Journal of the Marine Biological Association of the UK* 60:401-414.
- Grice G. D., Reeve M. R., Koeller P. & Menzel D. W., 1977. The use of large volume, transparent, enclosed sea-surface water columns in the study of stress on plankton ecosystems. *Helgoländer wissenschaftliche Meeresuntersuchungen* 30:118-133.
- Gust G., 1977. Turbulence and waves inside flexible-wall systems designed for biological studies. *Marine Biology* 42:47-53.
- Harada S., Adams E. E. & Takata R. S., 1999. Mixing within a free floating mesocosm using surface ocean wave energy. *Journal of Japan Society on Water Environment* 22:320-322.
- Heimdahl B. R., Egge J. K., Veldhuis M. J. W. & Westbroek P., 1994. The 1992 Norwegian *Emiliana huxleyi* experiment. An overview. *Sarsia* 79:285-290.
- Hesslein R. & Quay P., 1973. Vertical eddy diffusion studies in the thermocline of a small stratified lake. *Journal of the Fisheries Research Board of Canada* 30:1491-1500.
- Howarth R. W., Butler T., Lunde K., Swaney D. & Ren Chu C., 1993. Turbulence and planktonic nitrogen fixation: a mesocosm experiment. *Limnology and Oceanography* 38:1696-1711.

## Part 2: Experimental design of perturbation experiments

- Hurlbert S. H., 1984. Pseudoreplication and the design of ecological field experiments. *Ecological Monographs* 54:187-211.
- Kim J.-M., Lee K., Shin K., Kang J.-H., Lee H.-W., Kim M., Jang P.-G. & Jang M.-C., 2006. The effect of seawater CO<sub>2</sub> concentration on growth of a natural phytoplankton assemblage in a controlled mesocosm experiment. *Limnology and Oceanography* 51:1629-1636.
- Kim J. M., Shin K., Lee K. & Park B. K., 2008. In situ ecosystem-based carbon dioxide perturbation experiments: Design and performance evaluation of a mesocosm facility. *Limnology and Oceanography: Methods* 6:208-217.
- Kroer N. & Coffin R. B., 1992. Microbial trophic interactions in aquatic microcosms designed for testing genetically engineered microorganisms. *Microbial Ecology* 23:143-157.
- Kuiper J., 1977. Development of North Sea coastal plankton communities in separate plastic bags under identical conditions. *Marine Biology* 44:97-107.
- Kuiper J., Brockmann U. H., van het Groenewoud H., Hoornsman G. & Hammer K. D., 1983. Influences of bag dimensions on the development of enclosed plankton communities during POSER. *Marine Ecology Progress Series* 14:9-17.
- Lalli C. M., (Ed.), 1990. Enclosed experimental marine ecosystems: a review and recommendations, 218 p. New York: Springer-Verlag.
- Landahl M. T. & Mollo-Christensen E., 1986. *Turbulence and random processes in fluid mechanics*. 154 p. Cambridge: Cambridge University Press.
- Marrasé C., Lim E. L. & Caron D. A., 1992. Seasonal and daily changes in bacterivory in a coastal plankton community. *Marine Ecology Progress Series* 82:281-289.
- Martin L. E., 2001. Limitations on the use of impermeable mesocosms for ecological experiments involving *Aurelia* sp (Scyphozoa : Semaestomeae). *Journal of Plankton Research* 23:1-10.
- Menzel D. W. & Case J., 1977. Concept and design: controlled ecosystem pollution experiment. *Bulletin of Marine Science* 27:1-7.
- Menzel D. W. & Steele J. H., 1978. The application of plastic enclosures to the study of pelagic marine biota. *Rapports Et Procès-Verbaux Des Réunions Conseil International Pour L'Exploration De La Mer* 173:7-12.
- Müller P., 1980. Effects of artificial acidification on the growth of epilithiphyton. *Canadian Journal of Fisheries and Aquatic Sciences* 37:355-363.
- Nejstgaard J. C., Frischer M. E., Verity P. G., Anderson J. T., Jacobsen A., Zirbel M. J., Larsen A., Martínez-Martínez J., Sazhin A. F., Walters T., Bronk D. A., Whipple S. J., Borrett S. R., Patten B. C. & Long J. D., 2006. Plankton development and trophic transfer in seawater enclosures with nutrients and *Phaeocystis pouchetii* added. *Marine Ecology Progress Series* 321:99-121.
- Nejstgaard J. C., Gismervik I. & Solberg P. T., 1997. Feeding and reproduction by *Calanus finmarchicus*, and microzooplankton grazing during mesocosm blooms of diatoms and the coccolithophore *Emiliania huxleyi*. *Marine Ecology Progress Series* 147:197-217.
- Nejstgaard J. C., Hygum B. H., Naustvoll L. J. & Båmstedt U., 2001. Zooplankton growth, diet and reproductive success compared in simultaneous diatom- and flagellate-microzooplankton-dominated plankton blooms. *Marine Ecology Progress Series* 221:77-91.
- Nerheim S., Stiansen J. E. & Svendsen H., 2002. Grid-generated turbulence in a mesocosm experiment. *Hydrobiologia* 484:61-73.
- Nixon S. W., Alonso D., Pilson M. E. Q. & Buckley B. A., 1980. Turbulent mixing in aquatic microcosms. In: Giesy J. P. (Ed.), *Microcosms in ecological research, DOE Symposium series 52*, pp. 818-849. Springfield: National Technical Information Service.
- Oviatt C. A., 1981. Effects of different mixing schedules on phytoplankton, zooplankton and nutrients in marine microcosms. *Marine Ecology Progress Series* 4:57-67.
- Oviatt C. A., Keller A. A., Sampou P. A. & Beatty L. L., 1986. Patterns of productivity during eutrophication: a mesocosm experiment. *Marine Ecology Progress Series* 28:69-80.



- Oviatt C. A., 1994. Biological considerations in marine enclosure experiments: challenges and revelations. *Oceanography* 7:45– 51.
- Parsons T. R., 1981. The use of controlled experimental ecosystem: a review. *Journal of the Oceanographical Society of Japan* 37:294-298.
- Parsons T. R., 1982. The future of controlled ecosystem enclosure experiments. In: Grice G. D. & Reeve M. R. (Eds.), *Marine mesocosms. Biological and chemical research in experimental ecosystems*, pp. 411-418. New York: Springer-Verlag.
- Peters F. & Gross T., 1994. Increased grazing rates of microplankton in response to small-scale turbulence. *Marine Ecology Progress Series* 115:299-307.
- Petersen J. E., Sanford L. P. & Kemp W. M., 1998. Coastal plankton responses to turbulent mixing in experimental ecosystems. *Marine Ecology Progress Series* 171:23-41.
- Petersen J. E., Cornwell J. C. & Kemp W. M., 1999. Implicit scaling in the design of experimental aquatic ecosystems. *Oikos* 85:3-18.
- Petterson H., Gross F. & Koczy F., 1939. Large-scale plankton cultures. *Göteborgs Kungliga Vetenskaps och Vitterhets-Samhälles Handlingar Ser 5 B 6*:1-24.
- Pilson M. E. Q. & Nixon S. W., 1980. Marine microcosms in ecological research. In: Giesy J. P. (Ed.), *Microcosms in ecological research, DOE Symposium series 52*, pp. 724–741. Springfield: National Technical information Service.
- Prins T. C., Escaravage V., Pouwer A. J., Haas H. A. & Peeters J. C. H., 1994. Description of mesocosms, methods and comparison with North Sea conditions. In: Smaal A. C., Peeters J. C. H., Haas H. A. & Heip C. H. R. (Eds.), *The impact of marine eutrophication on phytoplankton and benthic suspension feeders. Progress report I: results of mesocosm experiments with reduced P-load and increased grazing pressure. Report RIKZ -94.035 / NIOO/CEMO*, pp. 10-40. Middelburg: Ministry of Transport, Public Works and Water Management, National Institute for Coastal and Marine Management/ RIKZ.
- Riebesell U., Bellerby R. G. J., Grossart H.-P. & Thingstad F., 2008a. Mesocosm CO<sub>2</sub> perturbation studies: from organism to community level. *Biogeosciences* 5:1157-1164.
- Riebesell U., Bellerby R., Grossart H.-P. & Thingstad F. (Eds.), 2008b. PeECE: pelagic ecosystem CO<sub>2</sub> enrichment studies. *Biogeosciences* 5:371-1527.
- Riebesell U., Schulz K. G., Bellerby R. G. J., Botros M., Fritsche P., Meyerhöfer M., Neill C., Nondal G., Oschlies A., Wohlers J. & Zöllner E., 2007. Enhanced biological carbon consumption in a high CO<sub>2</sub> ocean. *Nature* 450:545-549.
- Sanders F. S., 1985. Use of large enclosures for perturbation experiments in lentic ecosystems: A review. *Environmental Monitoring and Assessment* 5:55-99.
- Sanford L. P., 1997. Turbulent mixing in experimental ecosystem studies. *Marine Ecology Progress Series* 161:265-293.
- Schindler D. W., 1988. Effects of acid rain on freshwater ecosystems. *Science* 239:149-157.
- Schindler D. W., Mills K. H., Malley D. F., Findlay D. L., Shearer J. A., Davies I. J., Turner M. A., Linsey G. A. & Cruikshank D. R., 1985. Long-term ecosystem stress: the effects of years of acidification on a small lake. *Science* 228:1395-1401.
- Schindler D. W., 1980. Experimental acidification of a whole lake: a test of the oligotrophication hypothesis. In: Drablos D. & Tollan A. (Eds.), *Ecological impact of acid precipitation*, pp. 370-374. Oslo: Proceedings of an International Conference, Sande fjord, Norway, 11-14 March, SNSF Project.
- Schulz K. G., Barcelos e Ramos J., Zeebe R. E. & Riebesell U., 2009. CO<sub>2</sub> perturbation experiments: similarities and differences between dissolved inorganic carbon and total alkalinity manipulations. *Biogeosciences* 6:2145-2153.

- Schulz K. G., Riebesell U., Bellerby R. G. J., Biswas H., Meyerhöfer M., Müller M. N., Egge J. K., Nejstgaard J. C., Neill C., Wohlers J. & Zöllner E., 2008. Build-up and decline of organic matter during PeECE III. *Biogeosciences* 5:707-718.
- SCOR Working Group 85, 1991. Manual on marine experimental ecosystems, 2nd report. 178 p. Paris: UNESCO technical papers in marine science.
- Sommer U., Aberle N., Engel A., Hansen T., Lengfellner K., Sandow M., Wohlers J., Zöllner E. & Riebesell U., 2006. An indoor mesocosm system to study the effect of climate change on the late winter and spring succession of Baltic Sea phyto- and zooplankton. *Oecologia* 4:655-667.
- Sonntag N. C. & Parsons T. R., 1979. Mixing an enclosed, 1300 m<sup>3</sup> water column: effects on the planktonic food web. *Journal of Plankton Research* 1:85-102.
- Steele J. H., Farmer D. M. & Henderson E. W., 1977. Circulation and temperature structure in large marine enclosures. *Journal of the Fisheries Research Board of Canada* 34:1095-1104.
- Stephenson G. L., Hamilton P., Kaushik N. K., Robinson J. B. & Solomon K. R., 1984. Spatial distribution of plankton in enclosures of three sizes. *Canadian Journal of Fisheries and Aquatic Sciences* 41:1048-1054.
- Stiansen J. E. & Sundby S., 2001. Improved methods for generating and estimating turbulence in tanks suitable for fish larvae experiments. *Scientia Marina* 65:151-167.
- Svensen C., Egge J. K. & Stiansen J. E., 2001. Can silicate and turbulence regulate the vertical flux of biogenic matter? A mesocosm study. *Marine Ecology Progress Series* 217:67-80.
- Takahashi M., Thomas W. H., Seibert D. L. R., Beers J., Koeller P. & Parsons T. R., 1975. The replication of biological events in enclosed water columns. *Archiv für Hydrobiologie* 76:5-23.
- Takahashi M. & Whitney F. A., 1977. Temperature, salinity and light penetration structures: controlled ecosystem pollution experiment. *Bulletin of Marine Science* 27:8-16.
- Verity P. G., Zirbel M. J. & Nejstgaard J. C., 2007. Formation of very young colonies by *Phaeocystis pouchetii* from western Norway. *Aquatic Microbial Ecology* 47:267-274.
- Williams P. J. L. & Egge J. K., 1998. The management and behaviour of the mesocosms. *Estuarine, Coastal and Shelf Science* 46:3-14.

### 7 Laboratory experiments and benthic mesocosm studies

Steve Widdicombe<sup>1</sup>, Sam Dupont<sup>2</sup> and Mike Thorndyke<sup>2,3</sup>

<sup>1</sup>Plymouth Marine Laboratory, UK

<sup>2</sup>Department of Marine Ecology - Kristineberg, University of Gothenburg, Sweden

<sup>3</sup>Royal Swedish Academy of Sciences, University of Gothenburg, Sweden

#### 7.1 Introduction

There is an expectation from society and policymakers that the scientific community will be able to provide the knowledge that will guide them as they address the big environmental questions of the day. In the field of climate change, which includes both global warming and ocean acidification, the overriding political and societal needs are for predictions of the environmental consequences associated with continued atmospheric emissions of CO<sub>2</sub>. In particular, what will happen to species, populations, communities and ecosystems in the future and how will any changes affect the function of marine ecosystems? To fully understand the biological consequences of ocean acidification it is essential that the scientific community generates a holistic understanding of climate change impacts. However, to develop a comprehensive understanding takes time and this strategy can only be achieved too late to inform the political decisions needed to underpin strategies of carbon mitigation and societal adaptation. So, whilst the overall aim of any ocean acidification experiment should be to provide new data and understanding that will help the scientific community advance towards a holistic understanding, we must be realistic in what we can achieve with limited resources so as to provide clear answers or messages that help politicians, environmental managers and the public take action. For example, can we identify critical thresholds (or tipping points) of change? Which species, communities and ecosystems are most at risk? Will organisms be able to adapt to the predicted changes? The use of perturbation experiments is an extremely effective way of addressing these questions.

Field observations are usually confounded by the presence of many potentially important variables in addition to the one that interests us, and the relationships observed can only be described as correlative. Therefore, in order to demonstrate a direct “cause and effect” relationship it is necessary to conduct controlled, manipulative experiments. These experiments allow a single, or a limited suite of variables, to be manipulated and the effect on particular end-points compared against a control condition. It is important at this stage to recognise that all experiments are in fact abstractions from reality and all approaches have significant strengths and weaknesses (these will be discussed later). No single approach or experiment can explain all the potential impacts of ocean acidification on marine organisms, populations, communities and processes so instead we should see each individual experiment as a means of answering a specific question or providing specific knowledge that will advance our holistic understanding of the issue concerned. By considering how and by whom the results of your experiment will be used (see Figure 7.1) it is easier to appreciate what makes a “good and useful” experiment. In all cases, the methodologies must be appropriate for the questions posed, the results must be clear and statistically robust, and the study must be adequately reported.

The issue of ocean acidification is a young and maturing question of immense and increasing scientific concern. Unfortunately there are relatively few published papers (<50) that describe laboratory-based experiments specifically designed to examine the impacts of ocean acidification on benthic organisms and processes. More experiments are therefore vital across a range of groups, species, populations, functional groups, and physiological traits. The aim of this section is not to recommend particular experimental approaches or subjects for study over others, but to ensure that any experiments that are conducted are of maximum benefit to the whole ocean acidification research community and its stakeholders.

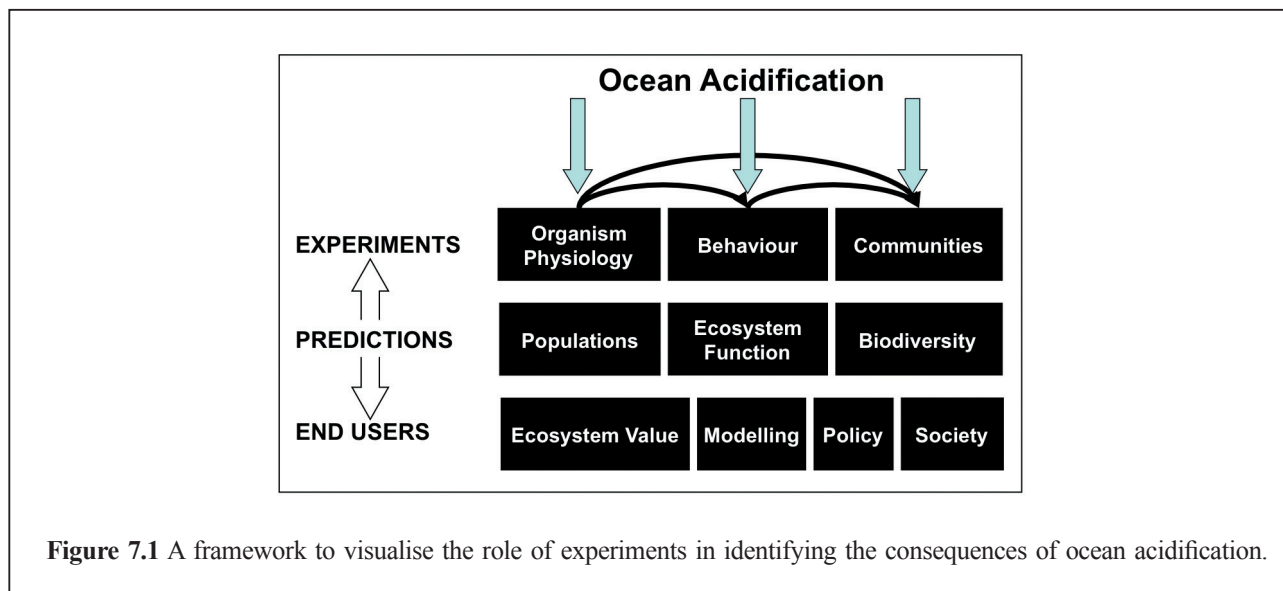

### 7.2 Approaches and methodologies

The oceans harbour incredible biological diversity (May, 1994; Reaka-Kudla, 1997) and the majority of this biodiversity is made up of invertebrates either residing in (infauna) or on (epifauna) the seafloor (Snelgrove, 1999). The benthos contains 98% of all marine species and harbours living representatives of all but one of the 29 non-symbiont animal phyla so far described. Given the importance of the benthic environment as a reservoir for biodiversity, there has been much speculation as to whether ocean acidification has the potential to reduce benthic biodiversity by impacting on key physiological (e.g. growth, respiration, calcification, metabolic rate) and ecological (e.g. competition, predation) processes in marine organisms (Widdicombe & Spicer, 2008).

Most benthic ocean acidification studies published to date have used highly, or fully, controlled single species experiments to look at specific responses and improve understanding of physiological mechanisms. Whilst these experiments are extremely important it should not be forgotten that they represent the most artificial of experimental situations, being isolated from many of the biological interactions (e.g. competition, predation, facilitation) that occur in the natural environment. In support of such controlled experiments it is important also to consider experiments that use not only single species but simple assemblages or even complex subsets of whole ecosystems. These microcosm or mesocosm experiments have been used with great success by the pelagic acidification research community (see chapter 6) but have yet to be fully exploited by researchers studying the effects of seawater acidification on benthic systems.

Studies to date have examined a wide range of physiological and ecological responses to ocean acidification; calcification (e.g. Gazeau *et al.*, 2007; Findlay *et al.*, sbm), acid-base regulation (e.g. Miles *et al.*, 2007; Spicer *et al.*, 2007), respiration (e.g. Wood *et al.*, 2008), fertilisation (e.g. Kurihara & Shirayama, 2004; Havenhand *et al.*, 2008; Byrne *et al.*, 2009), larval development (Dupont & Thorndyke, sbm), tissue damage (e.g. Wood *et al.*, 2008), immune response (e.g. Bibby *et al.*, 2008), assays of general health (e.g. Neutral Red Retention assay - Beesley *et al.*, 2008), feeding (e.g. Dupont & Thorndyke, 2008), burrowing (Widdicombe & Needham, 2007), survival (e.g. Dupont *et al.*, 2008), abundance (Dashfield *et al.*, 2008), diversity / community structure (e.g. Widdicombe *et al.*, 2009), all of which have been important in their own right. However, what is now evident is that changes in physiological processes can occur simultaneously within an organism. Consequently, in order to determine the effects of acidification on an individual's performance and survival, it is essential that data are collected that can be used to identify the physiological and ecological trade-offs which occur and therefore we consider impacts at a "whole organism" level (see Wood *et al.*, 2008 for a full description). This does not necessarily mean that experiments have to measure all of the parameters listed above but it does

highlight the necessity that studies are reported with sufficient detail as to allow accurate comparisons between experimental results.

Most published studies have so far only focused on limited aspects of natural life histories such as a single life stage, environment, etc. However, an individual may experience very different environmental conditions during its life. Consequently, an organism's performance and adaptation potential to a new stress can be extremely variable in space and time, e.g. many benthic organisms, particularly in coastal areas, spend a part of their life cycle as pelagic larvae, exposing them to potentially greater variability in seawater pH and carbonate saturation than when they are buried within the sediment as adults. Many organisms are mobile and can change their local environment, for example via daily/seasonal migrations or avoidance of stressful conditions by moving. A review of published studies indicates that many of the experiments so far conducted have been carried out over relatively short time scales; ranging from less than 24 hours exposure to a maximum of 30 weeks. While such comparatively short exposure times may be relevant to studies designed to assess the potential of ocean acidification to affect certain physiological and ecological processes, they do not truly reflect the rate or scale by which changes in seawater chemistry will occur and thus affect organisms over a longer timescale. Moreover, very few analyses have been attempted over several generations. Consequently, there is currently a severe lack of studies that adequately assess the potential for individuals, populations and communities to adapt to ocean acidification in the longer term.

Apart from previous studies that have explicitly investigated the impacts of acidification on calcification in corals and calcareous algae (see chapter 13) the majority of benthic experiments have used the addition of CO<sub>2</sub> gas to manipulate seawater chemistry; either as pure CO<sub>2</sub> gas (e.g. Widdicombe & Needham, 2007), as a specific air/CO<sub>2</sub> mixture (e.g. Kurihara *et al.*, 2007) or, in one case, the addition of flue gas generated by a power plant furnace (Palacios & Zimmerman, 2007). These approaches are described in detail in chapter 2.

### 7.3 Strengths and weaknesses

As previously noted, all experiments are an abstraction from reality and therefore represent a series of compromises (Figure 7.2). This does not mean that any one approach is better than another but we should be conscious of what each approach can provide and what it cannot.

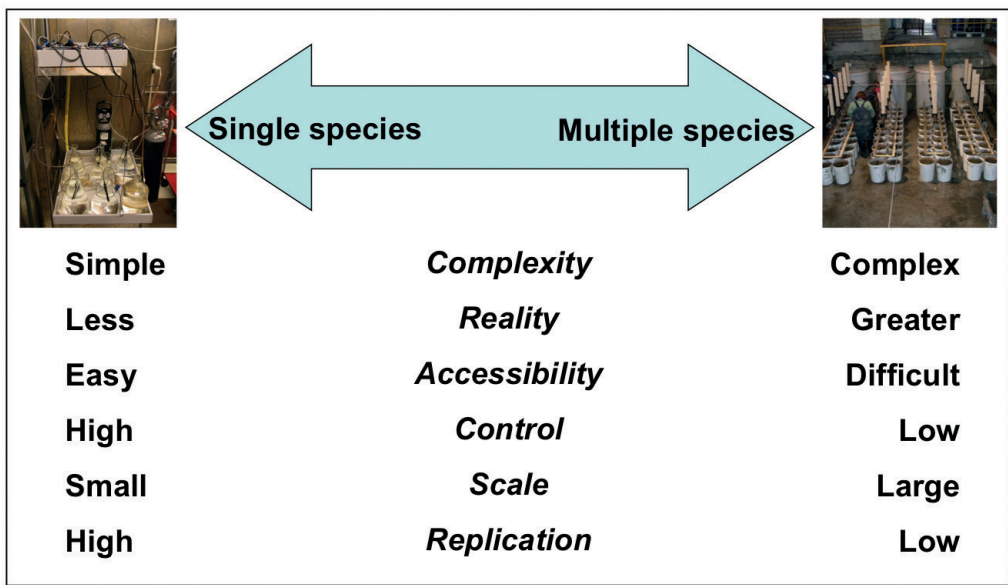

**Figure 7.2** A summary of the strengths and weaknesses of single species cultures and multiple species mesocosm experiments.

### 7.3.1 Experiments on single species

As these studies are conducted on individuals or species in isolation they are relatively easy to interpret (Figure 7.3). In general these experiments can be highly controlled with only a single variable being manipulated. Therefore the responses observed are not confounded by additional variables or by biological or environmental interactions. In cases where multiple variables are manipulated, the experiment can be designed with suitable replication to disentangle main effects and interactions (see chapter 4). In fact, the opportunity to fully replicate provides considerable statistical power and is a key strength of these kinds of laboratory experiments. In addition, sampling such experiments is usually relatively straightforward and easy access to the experimental subject can allow the observation of impacts over time. A major drawback, however, is the relevance of the data collected to the real world. In removing an organism from its natural habitat it is difficult to know whether it is in any way stressed and therefore whether it is behaving or functioning normally.

Also, whilst isolation from the highly variable natural environment can make identification of causality much easier, it should be remembered that an organism is normally exposed to a variety of stressors and the response identified in the artificial environment created in the laboratory may not actually manifest itself in the natural world. This means care in interpretation is critical.



**Figure 7.3** Larval cultures at the Sven Lovén ocean acidification facilities (University of Gothenburg). pH is dynamically controlled using pH-computers (Aquamedic) by injection of pure CO<sub>2</sub> in 5 l closed-circuit aquaria allowing an accuracy of 0.04 pH units (photo credit: S. Dupont).

### 7.3.2 Mesocosm experiments on natural assemblages and communities

This approach aims to enclose an intact sample of a natural community or ecosystem and expose it to experimental perturbation (see also chapters 6 and 13). These experiments are biologically complex which brings with it both major advantages and problems. The incorporation of natural, biological interactions means that results obtained from mesocosm studies are considered more relevant to natural situations than those from laboratory experiments. This additional realism aids in the scaling up of experimental results to field situations. In addition, keeping organisms in a more natural environment means they are less likely to become stressed than those in smaller scale laboratory experiments. However, although more “realistic” than single-species approaches, mesocosms are still not a precise replication of a natural system and this should be borne in mind when interpreting results and scaling up. In natural coastal environments, benthic organisms may be strongly linked to the pelagic environment. In addition to the coupling *via* pelagic larvae of benthic species, there are other interactions between pelagic and benthic species. These include feeding, predation, parasitism, propagation and seeding with dead organisms or products (e.g. house of appendicularians). For example, the quality of the food naturally coming from a complex pelagos may not be reproduced in mesocosm experiments, or there could be a reduction in competition because of an absence of natural recruitment.

A weakness of mesocosm experiments is that they are often large and it can be difficult and costly to achieve an ideal level of statistical replication. Whilst this should not be seen as a reason not to conduct mesocosm experiments, it is important to acknowledge statistical deficiencies and ensure interpretation of the results does not exceed the limits imposed by statistical constraints. For example, replication within a single mesocosm could be considered as pseudoreplication and therefore applicability of observations to situations outside of that mesocosm are limited (for a full explanation of pseudoreplication see chapter 4).

### 7.3.3 Mesocosm experiments on “artificial” assemblages and communities

Another approach can be employed to combine the strengths of experiments on single species (control of the variables manipulated, real replicates, decrease of experimental variability, etc.) with those of mesocosm experiments on natural assemblages and communities (biological complexity). The principle is to create artificial assemblages that mimic natural communities but with a controlled species composition, density, habitats etc. (Figure 7.4). This approach integrates biological interactions (feeding, predation, parasitism etc.) but decreases the variability due to the sampling effect of natural assemblages and communities, a factor particularly important in natural mesocosm experiments where replication is often limited.

In summary, benthic perturbation experiments can adopt a range of approaches that increase in complexity and reality from tightly controlled single species experiments through artificially assemblages to natural communities in mesocosms. All of which have different, yet complimentary strengths and weaknesses. Consequently, to fully appreciate the impacts of ocean acidification on benthic organisms and ecosystems we must utilise all of these approaches in addition to the field experiments and observations described in chapter 8.

## 7.4 Potential pitfalls

Many of the pitfalls associated with ocean acidification experiments will be the same as those encountered for all experiments involving marine organisms. For a good review of experimental practice see “Recommended texts for further reading” in chapter 4. Here we briefly summarise the major pitfalls.

### 7.4.1 Experimental stress

In any laboratory experiment organisms are being removed from their natural surroundings to some extent. This artificially imposed stress (termed here as experimental stress) could have a significant impact on an organism’s response and attempts should be made to reduce it as much as possible. Additional experimental



**Figure 7.4** Community based experiments being conducted in the seawater acidification facility housed at the Plymouth Marine Laboratory (photo credit: S. Widdicombe).

## Part 2: Experimental design of perturbation experiments

stress can occur in recalculating seawater systems if levels of metabolic waste are allowed to build up or if levels of oxygen are allowed to fall. However, it should also be recognised that organisms will be exposed to environmental stresses in the field as part of their natural existence (e.g. predation and competition). Bringing organisms into the laboratory or mesocosm can therefore liberate them from these natural stresses, which in turn could affect the results of any laboratory-based experiment.

### 7.4.2 Natural cycles

All organisms go through natural cycles; reproductive, growth, feeding, temperature; which can occur on a variety of time scales; diurnal, monthly, annually. For example, in the reproductive season there will be a different cycle of energy allocation with more resources going to the gonads and less going to support body maintenance or growth. At what point an organism is in a particular cycle can have a considerable effect on its physiological condition and how it will respond to specific perturbations. An appreciation of an organism's physiological condition at the time of the experiment is therefore vital for accurate interpretation of the results.

### 7.4.3 Influence of populations

An individual's response will be affected by its environmental history; intertidal vs. subtidal; range edge vs. mid range; naturally high or variable CO<sub>2</sub> areas. Thus, it is vital to take account of the ecophysiological parameters of the collection site as well as exploring the responses of samples taken from a variety of sites and populations.

### 7.4.4 Variability between individuals

Even within populations there will also be variability in response between individuals. This variability is part of the natural "noise" of experimental data and should be accounted for by ensuring adequate replication at the appropriate experimental level (see chapter 4).

### 7.4.5 Plasticity

Many organisms have the ability to alter their behaviour and/or physiology in response to an environmental change. However, this plasticity or acclimation depends on the speed at which the change occurs. Consequently, in perturbation experiments the speed at which the experimental treatment levels are imposed could have a significant impact on the results obtained. Presently there is no consensus as to whether acclimation should be used prior to exposure experiments or how long any acclimation period should be. Consequently, to assist future interpretation of results, papers should clearly report whether or not organisms were acclimated to the experimental treatment levels prior to exposure, and for how long.

### 7.4.6 Loss of natural processes

As previously discussed, experiments are an abstraction of reality and responses could be different when confounded by natural biological interactions.

### 7.4.7 Exposure time vs. organism longevity

In all experiments there is a need to consider the exposure time in relation to an organism's life span or the length of a particular life stage (life history and generation time). Long-lived species may have physiological mechanisms which enable them to cope with relatively short-term perturbations.

### 7.4.8 Synergistic stressors

So far there has been little attention on multiple environmental stressors. For example, the effects of climate change will include a number of stressors, such as temperature, pH, anoxia, salinity and physical disturbance, all occurring simultaneously.



## 7.5 Suggestions for improvements

The level of understanding currently available with which to make the required predictions of ecosystem responses to the environmental changes associated with ocean acidification is low. Consequently, all new studies generating observations and data are extremely valuable and all efforts should be made to ensure these studies are conducted and reported in the most appropriate and comprehensive manner.

As reported in section 7.4, two major pitfalls of perturbation experiments are associated with experimental stress and natural cycles. To ensure that the results of future experiments are as applicable to natural systems as possible, every attempt should be made to reduce experimental stress and understand natural cycles. To do this there should be an attempt to mimic, as closely as possible, the organism's natural conditions and cycles, for example temperature, salinity, light, food availability, tidal cycle and water flow. This means that before designing an experiment, a researcher should understand the underlying biological and chemical conditions of the area from which a study organism is to be taken. For the chemistry there is a need to assess natural variations (daily, seasonal, etc.) taking into account parameters such as the impact of biological activities on seawater chemistry, for example respiration, plus an organism's natural response to changing conditions, for example temporary migration to more favourable areas. These conditions will be life stage dependent and observations of field conditions should be mindful of this. If the intention is to conduct long-term studies, it is necessary to also take into account the natural behaviour of the species being studied as they may migrate to different habitats depending on season or age. In long-term experiments it may also be necessary to provide food. This should be supplied in relevant concentrations and in an appropriate form (e.g. algal species or prey item), which can vary according to season and life stage. When interpreting experimental results it would be useful to provide a measure of experimental stress. This could be done by comparing the experimental control group with individuals from the natural field population. Assessments of stress could include measures of metabolic activity (e.g. respiration, ventilation or heart rate) or assays of general health (e.g. Neutral Red Retention assay).

Another pitfall was concerned with the natural plasticity of organism response. Compared to the time available in which to conduct experiments, ocean acidification is actually occurring very slowly. Whilst rapid, "shock" experiments are very useful to identify the potential physiological and ecological processes that are vulnerable to high CO<sub>2</sub> levels, more effort needs to be made in mimicking the slow steady increase in ocean acidity. This includes long-term exposure experiments that superimpose a gradual decrease in seawater pH onto the natural pH cycle. In addition, experiments that deal with developmental and transgenerational issues should be conducted. For example, most experiments on larvae to date have taken eggs and sperm from specimens collected in the wild or from control aquaria and then exposed the resultant fertilised eggs and larvae to the lowered pH conditions. Here it is vital that adults too should be acclimated to the same pH ranges as those to which the larvae will be exposed. This is a truer reflection of the natural situation.

By using a range of treatment levels (>5) it is possible to describe the relationship observed between a perturbation and a response. When trying to identify critical thresholds or parameterise models, such relationships are more valuable than observations of impact based on one or two treatment levels. Experimentalists should not be reluctant to publish experiments that show "no response". Providing it can be shown that the lack of a response was genuine and not due to a lack of statistical power or inappropriate methodology, such observations are extremely valuable in determining the structure and function of future ecosystems. To ensure any study maximises its value to other users (scientists, policymakers, environmental managers etc.) it is essential that all relevant information be reported. These requirements are outlined below.

## 7.6 Data reporting

To ensure that the data and understanding generated from experiments provides the maximum benefit and value to all relevant end-users, particularly fellow scientists and policymakers, it is essential that all relevant

## Part 2: Experimental design of perturbation experiments

data be accurately reported in scientific publications. For ocean acidification perturbation experiments on benthic organisms and processes we suggest the following data should be collected and reported.

### 7.6.1 Specimen state and quality

- Where (location, habitat, place) and when (date and time) the specimens were collected.
- The organisms mean body size plus the maximum and minimum sized animal used.
- The sex and reproductive state of the organisms.
- Organism's age or developmental stage.

### 7.6.2 Relevance of experimental treatments to natural field conditions

- The environmental conditions at the specimen collection site.
- The natural values observed in field populations for each of the response variables measured in the study.

### 7.6.3 Experimental conditions

- The mean ( $\pm$  a measure of error), maximum and minimum temperature and salinity in each treatment.
- The mean ( $\pm$  a measure of error), maximum and minimum for at least two measures of carbonate chemistry from each treatment (see chapter 1).
- Accurate description of the methods used to measure carbonate parameters including pH scales and buffers where appropriate.
- State whether the experimental subjects were given a period of gradual acclimation (state the size of the incremental changes and the length of time between steps or total acclimation period) or whether they were immediately exposed to the full treatment levels.
- Report any indications or measures of stress in the experimental organisms. Compare these data to field specimens where possible.
- State the length of time organisms were exposed to the treatments.

## 7.7 Recommendations for standards and guidelines

1. Optimise the limited resources (time, space, money, people) to provide answers that help politicians, environmental managers and society to adapt to and mitigate change.
2. Methodologies and experimental design must be appropriate for the question posed (Figure 7.1).
3. To have a realistic picture of the real impact of ocean acidification on a species, it is important to take into account the “whole organism” level and to integrate environmental variability in space and time experienced by an organism.
4. When the goal is to study the ecological impact, an experiment needs to be realistic and mimic the real conditions experienced by the organisms both for biotic and abiotic conditions.
5. The stresses experienced by an organism during an experiment, other than that caused by the perturbation of interest, should be kept at its natural level (reduce experimental stress and keep “normal” stress).
6. Experiments should be designed to assess natural plasticity within species and populations. These will necessitate the use of long-term exposures that cover multiple generations.
7. Ocean acidification should be investigated in synergy with other stressors.
8. All data should be reported with all the information to allow comparison between studies, even data showing “no effects”.

## 7.8 References

- Beesley A., Lowe D. M., Pascoe C. K. & Widdicombe S., 2008. Effects of CO<sub>2</sub>-induced seawater acidification on the health of *Mytilus edulis*. *Climate Research* 37:215-225.
- Bibby R., Widdicombe S., Parry H., Spicer J. & Pipe R., 2008. Effects of ocean acidification on the immune response of the blue mussel *Mytilus edulis*. *Aquatic Biology* 2:67-74.
- Byrne M., Ho M., Selvakumaraswamy P., Nguyen H. D., Dworjanyn S. A. & Davis A. R., 2009. Temperature, but not pH, compromises sea urchin fertilization and early development under near-future climate change scenarios. *Proceedings of the Royal Society B: Biological Sciences* 276:1883-1888.
- Dashfield S. L., Somerfield P. J., Widdicombe S., Austen M. C. & Nimmo M., 2008. Impacts of ocean acidification and burrowing urchins on within-sediment pH profiles and subtidal nematode communities. *Journal of Experimental Marine Biology and Ecology* 365:46-52.
- Dupont S., Havenhand J., Thorndyke W., Peck L. & Thorndyke M., 2008. Near-future level of CO<sub>2</sub>-driven ocean acidification radically affects larval survival and development in the brittlestar *Ophiothrix fragilis*. *Marine Ecology Progress Series* 373:285-294.
- Dupont S. & Thorndyke M. C., 2008. Ocean acidification and its impact on the early life-history stages of marine animals. In: Briand F. (Ed.), *Impacts of acidification on biological, chemical and physical systems in the Mediterranean and Black Seas*, pp. 89-97. Monaco: CIESM.
- Gazeau F., Quiblier C., Jansen J. M., Gattuso J.-P., Middelburg J. J. & Heip C. H. R., 2007. Impact of elevated CO<sub>2</sub> on shellfish calcification. *Geophysical Research Letters* 34, L07603. doi:10.1029/2006GL028554.
- Havenhand J. N., Buttler F.-R., Thorndyke M. C. & Williamson J. E., 2008. Near future levels of ocean acidification reduce fertilization success in a sea urchin. *Current Biology* 18:R651-R652.
- Kurihara H., Kato S. & Ishimatsu A., 2007. Effects of increased seawater pCO<sub>2</sub> on early development of the oyster *Crassostrea gigas*. *Aquatic Biology* 1:91-98.
- Kurihara H. & Shirayama Y., 2004. Effects of increased atmospheric CO<sub>2</sub> on sea urchin early development. *Marine Ecology Progress Series* 274:161-169.
- May R. M., 1994. Biological diversity - differences between land and sea. *Philosophical Transactions of the Royal Society B* 343:105-111.
- Miles H., Widdicombe S., Spicer J. I. & Hall-Spencer J., 2007. Effects of anthropogenic seawater acidification on acid-base balance in the sea urchin *Psammechinus miliaris*. *Marine Pollution Bulletin* 54:89-96.
- Palacios S. L. & Zimmerman R. C., 2007. Response of eelgrass *Zostera marina* to CO<sub>2</sub> enrichment: possible impacts of climate change and potential for remediation of coastal habitats. *Marine Ecology Progress Series* 344:1-13.
- Reaka-Kudla M. L., 1997. The global biodiversity of coral reefs: A comparison with rainforests. In: Reaka-Kudla M. L., Wilson D. E. & Wilson E. O. (Eds.), *Biodiversity II: understanding and protecting our natural resources*, pp. 83-108. Washington, D. C.: Joseph Henry/National Academy Press.
- Snelgrove P. V. R., 1999. Getting to the bottom of marine biodiversity: sedimentary habitats - ocean bottoms are the most widespread habitat on Earth and support high biodiversity and key ecosystem services. *Bioscience* 49:129-138.
- Spicer J. I., Raffo A. & Widdicombe S., 2007. Influence of CO<sub>2</sub>-related seawater acidification on extracellular acid-base balance in the velvet swimming crab *Necora puber*. *Marine Biology* 151:1117-1125.
- Widdicombe S., Dashfield S. L., McNeill C. L., Needham H. R., Beesley A., McEvoy A., Øxnevad S., Clarke K. R. & Berge J. A., 2009. Effects of CO<sub>2</sub> induced seawater acidification on infaunal diversity and sediment nutrient fluxes. *Marine Ecology Progress Series* 379:59-75.
- Widdicombe S. & Spicer J. I., 2008. Predicting the impact of ocean acidification on benthic biodiversity: What can animal physiology tell us? *Journal of Experimental Marine Biology and Ecology* 366:187-197.

- Widdicombe S. & Needham H. R., 2007. Impact of CO<sub>2</sub>-induced seawater acidification on the burrowing activity of *Nereis virens* and sediment nutrient flux. *Marine Ecology Progress Series* 341:111-122.
- Wood H. L., Spicer J. I. & Widdicombe S., 2008. Ocean acidification may increase calcification rates, but at a cost. *Proceedings of the Royal Society B: Biological Sciences* 275:1767-1773.

### 8 *In situ* perturbation experiments: natural venting sites, spatial/temporal gradients in ocean pH, manipulative *in situ* p(CO<sub>2</sub>) perturbations

James P. Barry<sup>1</sup>, Jason M. Hall-Spencer<sup>2</sup> and Toby Tyrrell<sup>3</sup>

<sup>1</sup>Monterey Bay Aquarium Research Institute, USA

<sup>2</sup>Marine Institute, University of Plymouth, UK

<sup>3</sup>National Oceanography Centre, University of Southampton, UK

#### 8.1 Introduction

The objectives of *in situ* experiments studying ocean acidification vary widely, with most recent studies centering on the effects of changing carbonate chemistry on the biology and ecology of organisms and ecosystems. The advantages of *in situ* observations are that they offer a completely independent approach to laboratory experiments, one that is based on looking directly at how organisms and communities and ecosystems react to high/low pH and saturation state ( $\Omega$ ) in the real world, replete with all its biodiversity, ecosystem interactions and adaptation to the ambient chemistry. Studies have included measurements of faunal patterns, calcification, dissolution, growth, survival, metabolic rate, physiological responses, behaviour, community interactions, and other processes, in relation to spatial and/or temporal changes in pH, p(CO<sub>2</sub>), or aragonite and calcite saturation states. Here, we focus principally on the approach and methods of *in situ* experimental studies, using examples of recent work and developing techniques. Two major types of *in situ* experiments are used for ocean acidification research including:

- ***In situ* observational studies** that compare patterns or processes between areas that differ *naturally* in seawater acidity and/or carbonate saturation states.
- ***In situ* perturbation experiments**, where researchers manipulate conditions to compare patterns or processes between *artificially* acidified and control conditions.

##### 8.1.1 *In situ* observational studies

Observational studies, also termed natural experiments, allow researchers to exploit gradients in ocean chemistry that exist at sites such as hydrothermal or other CO<sub>2</sub> vent sites, across changes in pH with depth or among sites, or even between ocean basins. Natural differences in carbonate chemistry between sites can differ by as much as those associated with a doubling of atmospheric CO<sub>2</sub> (Rost *et al.*, 2008). Researchers typically have little or no control over treatments in *in situ* observational studies, and measure differences between parameters of interest (e.g. calcification, abundance etc.) along local gradients in pH or other carbonate system parameters, or between sites or depths that differ in ocean chemistry. The main weakness of *in situ* observational studies is the potential for significant, but hard to detect effects of confounding factors that vary among locations with (or independent of) seawater carbonate chemistry. Waters emanating from deep-sea vent sites, for example, are rich in carbon dioxide, but often have high concentrations of methane, sulfide, heat and other parameters. Each of these factors may affect the physiology and performance of individual organisms in the community, with cascading effects on community patterns and processes. In addition, treatments in observational studies are usually segregated in space (as well as variable over space and time), making it difficult to intersperse replicates among treatments. For research on ocean acidification, however, the great advantage of *in situ* observational studies is their increased realism, both in terms of long duration and inclusion of all elements of the ecosystem. The long-term nature of environmental conditions examined in most *in situ* observational studies allows sufficient time for the development of both the direct effects of chronic ocean acidification on organisms, and the emergence of any cascading indirect impacts (if any) on ecological patterns and

## Part 2: Experimental design of perturbation experiments

processes. These time scales are much longer than is typically possible for manipulative ocean acidification experiments. See chapter 4 for further discussion on the design of ocean acidification experiments.

Unlike *in situ* observational studies, most recent studies of the effects of ocean acidification have been based on acute exposure in laboratory and mesocosm experiments whereby CO<sub>2</sub> levels were manipulated over short timescales – see chapters 6 and 7 for further information on these methods. However, attempts to determine whether these experimental results and related models provide realistic predictions of future impacts of chronic ocean acidification have been hindered by the difficulty of simulating ocean acidification *in situ* over long periods. Thus, it is possible that the responses to increased CO<sub>2</sub>/acidity observed in short-term experiments are related principally to acute exposure, and may not represent the effects of chronic ocean acidification that may include long-term acclimation, evolutionary adaptation, changes in the composition of the species assemblage, and also complex feedbacks and indirect effects occurring within a natural marine system.

The opportunities to observe the long-term consequences of elevated p(CO<sub>2</sub>) or acidity using *in situ* observational studies has prompted a number of recent studies investigating processes such as calcification, photosynthesis, growth and community structure. Tyrrell *et al.*, (2008) reported that coccolithophores are common in the Black Sea, but absent from the Baltic, which undergoes seasonal aragonite undersaturation. In a similar study, Marshall *et al.*, (2008) found that shell dissolution of marine gastropod populations (*Thais* sp.) varies in concert with pH in Southeast Asian estuaries. However, because salinity, temperature, light, or some combination of these factors varied with pH among sites in each study, it is difficult to disentangle the effects of these potentially confounding factors. Another interesting recent report of an *in situ* observational study on ocean acidification is an examination of variation in community composition along a natural pH gradient in a shallow subtidal community around the small island of Ischia off the Italian coast (Hall-Spencer *et al.*, 2008). Dramatic changes in faunal and floral composition with pH (7.4 - 8.2) indicate that long-term exposure to high-CO<sub>2</sub>/low-pH waters benefits some seagrasses, but is detrimental to other species, such as corals and coralline algae (Hall-Spencer *et al.*, 2008; Martin *et al.*, 2008). Although the strong correspondence between gradients in faunal patterns and pH are striking, the limited spatial scale of the venting site provides only one venting area on each side of the island, and temporal variation in pH may be large. The limited potential for replication (n = 2 sites) increases the likelihood of confounding – site to site variation in factors other than pH may drive faunal gradients, particularly if pH variation is great. Natural venting sites have also provided evidence concerning the influence of pH and/or p(CO<sub>2</sub>) levels on deep-sea community patterns (Vetter & Smith, 2005). Echinoderms are known in general to be rare or absent from hydrothermal vent sites (typically low in pH) where many chemosynthetic communities thrive (Grassle, 1985; Van Dover, 2000). Tunnicliffe *et al.* (2009) observed clusters of the vent mussel *Bathymodiolus brevior* growing (albeit with poorly-formed shells) in extremely acidic conditions (pH values between 5.4 and 7.3) near deep hydrothermal vents where predatory crabs are absent. In addition, recent surveys of biological patterns in the vicinity of CO<sub>2</sub>-rich vent sites in the Okinawa Trough (Boetius *et al.*, unpubl.) indicate strong coupling of faunal patterns and pH. However, most observations to date from deep-sea vents have been influenced not only by high CO<sub>2</sub> but also by the effects of heat and H<sub>2</sub>S or CH<sub>4</sub>.

Spatial gradients have been used to assess the sensitivity of cold-water corals (>95% live where aragonite saturation state ( $\Omega_a$ ) is currently  $\geq 1$ ; Guinotte *et al.*, 2006) and warm-water corals (most live where  $\Omega_a$  was  $>3.5$  in 1750, Kleypas *et al.*, 1999) to carbonate saturation, their calcification strength (Manzello *et al.*, 2008) and their rates of dissolution (e.g. Andersson *et al.*, 2007). Temporal changes in carbonate saturation, pH, or p(CO<sub>2</sub>) that occur over diurnal cycles, through the boom and bust of plankton blooms, over seasons, and longer time scales (Bensoussan & Gattuso, 2007; Findlay *et al.*, 2008; Tyrrell *et al.*, 2008; Wootton *et al.*, 2008) also provide opportunities for ocean acidification studies. Changes in carbonate chemistry have now been documented over decadal and longer scales at several sites, yet few reports of corresponding changes in community structure or function are available (but see Cooper *et al.*, 2008). Most studies of temporal changes in ocean chemistry or associated faunal patterns or processes have examined carbonate sediments preserved over long (i.e. thousands to millions of years) periods (e.g. Hönisch & Hemming, 2005). Recent work by

Iglesias-Rodriguez *et al.* (2008), however, detected changes in coccolithophore calcification in the sediment record over only two centuries, though the cause of these changes remains unknown.

Areas where  $p(\text{CO}_2)$  levels are high, and pH and carbonate saturations are low, provide systems for studies of the long-term effects of ocean acidification because the acidified seawater conditions at such sites occur on sufficiently large spatial and temporal scales to integrate ecosystem processes such as production, competition and predation (Hall-Spencer *et al.*, 2008). However, there are considerable differences between such systems and that of global-scale ocean acidification caused by rising atmospheric  $\text{CO}_2$ . For example, temporal and spatial variability in  $\text{CO}_2$  and pH perturbations around vent sites or over short distances over oceanographic gradients complicate the determination of a reliable dose – response relationship (Riebesell, 2008). Global-scale acidification will almost certainly be more stable in time and space. In addition, other important factors, such as natural temperature or salinity variation among sampling sites, or emigration and immigration of organisms from venting sites or other treatment locations can complicate the interpretation of observed effects of high  $\text{CO}_2$  at naturally acidified sites. However, evidence demonstrating the ability to survive at low pH/saturation provides important information about the consequences of ocean acidification, regardless of values of other factors. Natural study sites will therefore need to be used in conjunction with more controlled approaches to help predict the future effects of ocean acidification. See chapters 6 and 7 concerning some pH control experiments in laboratory and field settings.

Natural venting sites and spatial/temporal gradients in ocean pH can also be exploited as laboratories for manipulative experiments concerning the effects of ocean acidification. Although treatment levels may not be controlled, it is possible to manipulate conditions within ocean acidification treatments (e.g. translocation experiments - moving organisms in and out of natural sites that differ in ocean carbonate chemistry). By exposing trapped amphipods to  $\text{CO}_2$ -rich fluids venting from the Loihi Seamount, Vetter & Smith (2005) observed the onset and recovery from  $\text{CO}_2$ -induced torpor (inactivity). Likewise, numerous manipulative experimental studies are in progress at the shallow  $\text{CO}_2$  venting sites off Ischia (e.g. Rodolfo-Metalpa *et al.*, in press), where the effects of ocean acidification on animal biology, ecological interactions and succession, as well as other topics can be evaluated under naturally varying  $p(\text{CO}_2)$  treatments.

### 8.1.2 *In situ* perturbation experiments

*In situ* perturbation experiments are those where researchers control one or more factors and replicate observations for comparisons between control and treatments groups or along gradients in ocean chemistry. *In situ* perturbation experiments, also called “field experiments”, have greater control on experimental parameters and can usually include a more fully factorial and replicated design (see chapter 4) than observational studies. However, because most variables in field experiments are not controlled, conditions are inherently more variable than in laboratory experiments, with potentially large effects on the variance within and among groups. Nevertheless, measuring performance of organisms or other processes in a natural setting provides more realism than is typically possible in laboratory experiments.

Field experiments where researchers have controlled pH or  $p(\text{CO}_2)$  have been performed in deep-sea environments, with ongoing efforts in various habitats. Studies to date have ranged from releases of liquid  $\text{CO}_2$  or  $\text{CO}_2$ -rich fluids to examine effects of environmental hypercapnia on deep-sea fauna (e.g. Tamburri *et al.*, 2000; Barry *et al.*, 2005; Thistle *et al.*, 2005), and the deployment of chamber systems capable of modifying pH/ $p(\text{CO}_2)$  in enclosed samples of seabed (Ishida *et al.*, 2005). Recent developments to enable *in situ* perturbation experiments concerning ocean acidification include more advanced chamber systems and open or semi-enclosed systems that emulate the Free Air  $\text{CO}_2$  Enrichment (FACE; Ainsworth & Long, 2005) facilities used for decades to evaluate the effects of elevated atmospheric  $\text{CO}_2$  levels on terrestrial communities. Free Ocean  $\text{CO}_2$  Enrichment (FOCE) systems may allow long-term (weeks to months) experiments with controlled pH treatments in marine communities without isolating the study area from input (currents, plankton etc.) from the surrounding area (Walz *et al.*, 2008).

### 8.2 Approaches and methodologies

#### 8.2.1 Design of experiments

Although a more thorough treatment of issues to consider in designing any experimental study is available in chapter 4, *in situ* experiments (natural or manipulative) have special considerations to maximise inferential power. For *in situ* observational studies, replication, randomisation, and interspersions of replicates among treatments are often difficult. Natural venting sites are relatively rare, at least in shallow waters, limiting opportunities for replication of sites. Persistent natural gradients in ocean chemistry typically may be linked to other processes, such that treatment levels for pH or other ocean acidification parameters positioned along the gradient may overlap gradients in confounding factors. In addition, venting sites may be concentrated in a single area, reducing opportunities for replication and interspersions of treatments. Manipulative ocean acidification experiments that use natural venting sites or gradients in ocean chemistry as treatments into which subjects (i.e. animals, carbonate etc.) are placed also suffer from problems of replicate interspersions and potentially confounding factors. Thus, to exploit natural patterns in ocean chemistry for ocean acidification studies, researchers have made compromises that violate, to some degree, the principles of experimental design, but which nonetheless have great value in ocean acidification research. Inference gained from a weak experimental design can ideally be supplemented using controlled *in situ* or laboratory experiments to examine more closely patterns or processes suggested to be linked with ocean acidification parameters from field studies. This approach has been used effectively by Hall-Spencer *et al.* (2008) as an independent test of the role of ocean acidification in faunal patterns (Fabry *et al.* 2008). For controlled *in situ* experiments, interspersions of replicates among treatments should be less problematic, but control of pH and  $p(\text{CO}_2)$  may be logistically difficult, limiting studies to short periods.

#### 8.2.2 *In situ* observational studies

##### *Observational studies along natural gradients in ocean chemistry*

The general approach in studies exploiting natural  $\text{CO}_2$  venting sites or other natural gradients in pH has been to examine the relationship among samples of interest (e.g. faunal structure, carbonate dissolution rates) along a gradient in or zones of pH or other carbonate system parameters. Hall-Spencer *et al.* (2008) made careful measurements of community structure and ocean pH, alkalinity, temperature and other factors around  $\text{CO}_2$  vents off the Mediterranean island of Ischia, providing strong evidence that pH was a driver of community structure (Figure 8.1), though the range and variability in pH was greater than is expected under most future climate scenarios. Likewise, Inagaki *et al.* (2006) documented patterns in microbial community structure along gradients in sediment pH and  $p(\text{CO}_2)$  in the Yonaguni Knoll hydrothermal vent field in the Okinawa Trough. In each case, researchers measured variation in ocean acidification parameters and the ecological measures of interest (abundance and distribution of organisms).

The approach for controlled field studies varies depending on the goals of the study and the potential for control of seawater carbonate system parameters. For exploiting natural vent sites or gradients in pH or  $p(\text{CO}_2)$ , treatment levels may be determined by placing samples of study organisms in locations with the desired levels of pH or other parameters, preferably replicated among several sites. As for observational studies, ocean acidification parameters, as well as other potentially important factors, must be characterised carefully. Vetter & Smith's (2005) study of the effects of low pH waters on deep-sea amphipods (*Eurythenes cf. obesus*) exploited natural pH variation at the Loihi Seamount vent site. Amphipods were captured in baited traps and placed for short periods (15-60 min) in the hypercapnic (pH ~ 6.0) and slightly warmer (~8°C) vent waters from the Loihi Seamount. Comparisons of their behaviour prior to and after exposure, coupled with observations during ascent into warmer waters, indicated that torpor was induced by exposure to the hypercapnic plume. Amphipods were otherwise active until reaching depths during ascent where temperatures were above 10 to 11°C. Although only a single site was available, the experiment was repeated several times with consistent results.



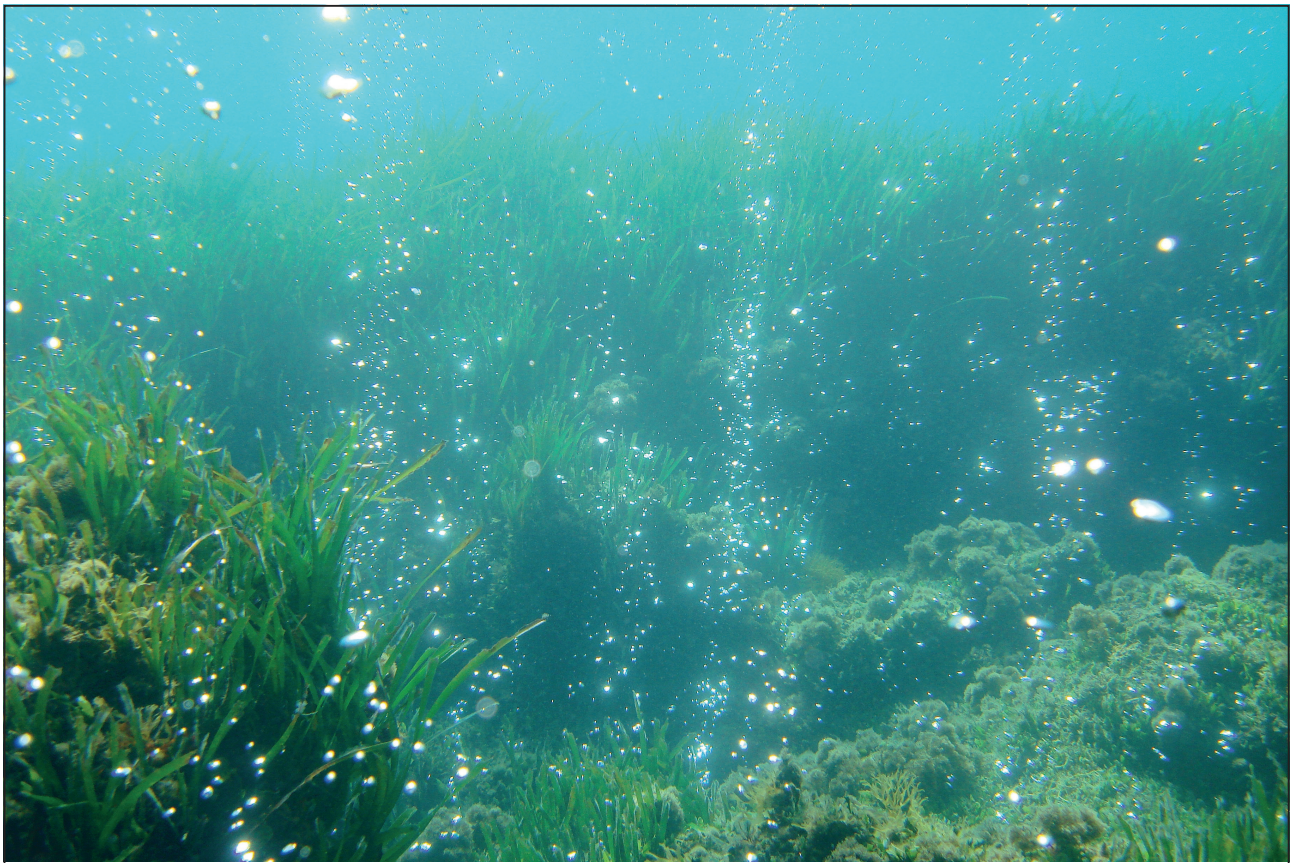

**Figure 8.1** Sparkling seawater. Venting of volcanic  $\text{CO}_2$  near the Mediterranean island of Ischia provides a natural experiment to observe changes in a rocky shore ecosystem along gradients of decreasing pH close to the vents (photo credit: J. Hall-Spencer).

### 8.2.3 *In situ* perturbation experiments

Field experiments in which researchers perturb carbonate system conditions to examine the performance of organisms (e.g. calcification, survival, growth, metabolism) or communities (e.g. community structure, succession), or a process of interest (e.g. dissolution rates), are based on comparisons among treatments, typically using a factorial design for ANOVA comparisons, or a regression design. Treatments to study the effects of ocean acidification can be created artificially or may occur naturally, as described above for *in situ* observational studies.

A small number of *in situ* studies have controlled carbonate chemistry treatments directly to examine their effects on animal biology or  $\text{CO}_2$  chemistry. The approach of these studies has been to release liquid  $\text{CO}_2$  or seawater saturated with  $\text{CO}_2$  to produce pH/p( $\text{CO}_2$ ) perturbations, which are used as treatments to assess animal survival or performance.  $\text{CO}_2$ -saturated seawater is prepared by bubbling reagent-grade carbon dioxide through seawater within gas tight containers at a known temperature. Brewer *et al.* (2001) first developed a Remotely Operated Vehicle (ROV) based system to release liquid  $\text{CO}_2$  in the deep-sea for studies of ocean carbon dioxide storage, which has now been used to investigate the effects of ocean acidification in general. Tamburri *et al.* (2000) released a  $\text{CO}_2$ -saturated seawater solution alone or in tandem with a fish odour (homogenised tuna extract) to evaluate the response of benthic scavengers. Although a single system was used and the experiment was repeated only twice, they showed that several scavengers displayed no avoidance to  $\text{CO}_2$ -rich odour plumes released near the seabed. Barry *et al.* (2004) created pools of liquid  $\text{CO}_2$  on the abyssal seabed in a series of experiments to evaluate the impacts

## Part 2: Experimental design of perturbation experiments

of environmental hypercapnia on deep-sea biota. Pools (20 to 100 l) of liquid CO<sub>2</sub> were released into small PVC corrals using an ROV-based CO<sub>2</sub> delivery system. The CO<sub>2</sub> dissolved into the bottom waters over 2 to 4 weeks, producing a CO<sub>2</sub>-rich dissolution plume that drifted with ambient bottom currents over local sediments and experimental animals held in cages. For ANOVA-design experiments, corrals were arranged haphazardly on the seabed, with control corrals interspersed among those filled with CO<sub>2</sub>. Animal survival and abundance was measured near control and treatment corrals. Regression designs with a larger CO<sub>2</sub> pool positioned centrally were also used to document pH and animal survival versus distance ( $\sim\Delta\text{pH}$ ). Local variation in currents, temperature and pH was measured with *in situ* sensors throughout each experiment to document spatial and temporal variation in pH. These experiments (e.g. Figure 8.2) demonstrated the sensitivity of various deep-sea organisms to large ( $\Delta\text{pH} \sim 0.5$  to 1.0 units; Barry *et al.*, 2004) and relatively modest ( $\Delta\text{pH} < \sim 0.3$  units; Barry *et al.*, 2005; Thistle *et al.*, 2005; Fleeger *et al.*, 2006) reductions in deep-sea pH. Although these CO<sub>2</sub> release experiments effectively perturbed the p(CO<sub>2</sub>)/pH of abyssal waters for these experiments, variation in bottom turbulence, current speed and direction resulted in large variation in pH through the experiments, complicating interpretation of results (Barry *et al.*, 2005).

Because plankton move with ocean currents, their study via *in situ* perturbation experiments requires different techniques. An established technique is to transfer a volume of *in situ* seawater into a tank on the



**Figure 8.2** Photograph of manipulative deep-sea experiment to evaluate the response of deep-sea organisms to low pH / high p(CO<sub>2</sub>). Liquid CO<sub>2</sub> ( $\sim 60$  l) was released into PVC tubes ( $\sim 45$  cm diameter) placed on the seafloor at 3600 m depth off central California. The liquid CO<sub>2</sub> dissolved into seawater, producing a high CO<sub>2</sub>, low pH plume that drifted over the seabed and organisms in the sediment or held in cages at different distances from the CO<sub>2</sub> pools (photo credit: J.P. Barry).

deck of a research vessel, and then subject the natural plankton assemblage to different manipulated CO<sub>2</sub> levels. This technique has been used for a number of studies, including the response to elevated CO<sub>2</sub> of coccolithophore calcification (Riebesell *et al.*, 2000), phytoplankton carbon uptake (Tortell *et al.*, 2008) and pteropod shell formation (Orr *et al.*, 2005). Nutrients in the on-deck incubations are transferred with the ambient seawater. Light levels and temperature are higher on deck, which is typically compensated for by the use of blue-coloured light filters around the incubations, and by pumping ambient water around the tanks to keep them cool.

#### 8.2.4 *In situ* chamber systems for ocean acidification studies

The development of *in situ* ocean acidification experiments with greater control over experimental conditions have made progress recently, with technically sophisticated designs for chamber systems and partially-enclosed pH control systems. A metabolic chamber system capable of pH perturbations by injection of CO<sub>2</sub>-rich seawater was developed by Ishida *et al.* (2005). The system, including 3 replicate chambers, logs chamber pH and O<sub>2</sub>, has been deployed repeatedly as a free vehicle to measure changes in microbial and meiofaunal abundance and metabolism under environmental normocapnia and hypercapnia.

Free Ocean CO<sub>2</sub> Enrichment (FOCE) systems are under development to mimic Free Air CO<sub>2</sub> Enrichment (FACE) facilities that have been used for over a decade to study the effects of increased atmospheric CO<sub>2</sub> on terrestrial communities (Ainsworth & Long, 2005). Similar to FACE systems, the FOCE design (Brewer *et al.*, 2005) is capable of injecting CO<sub>2</sub>-rich seawater along the up-current margin of the enclosed lattice system to maintain a specified pH/p(CO<sub>2</sub>) perturbation within the enclosed experimental section (Figure 8.3). FOCE systems will be automated to allow for long-term manipulative experiments in various habitats, such as coral reefs, soft-sediment benthos, kelp beds, intertidal zones, and potentially deep-sea coral communities. FOCE systems presently exist only as prototypes (Walz *et al.*, 2008) with a small control area (1 × 1 × 0.5 m) enclosed within a flume (Figure 8.2).

#### 8.2.5 Assessing the effects of ocean acidification

Because the focus of ocean acidification studies varies widely, it is beyond the scope of this section to provide a comprehensive treatment of approaches and methods for quantifying effects of ocean acidification on response variables. For both natural and manipulative field experiments, however, response variables (e.g. survival, growth etc.) have typically been measured in parallel with measurements of carbonate system parameters to allow for regression or ANOVA analyses. For observational studies it is important to make high quality measurements of potential confounding factors (e.g. temperature, salinity, nutrient levels, light intensities) as well as of carbonate chemistry, so that their ability to explain observed changes in a variable(s) of interest (e.g. size-normalised foraminiferal weight) can be compared statistically. The appropriate statistical techniques to be used will depend on the details of the study, but techniques to be considered include calculation of correlation statistics, multiple regression analyses and analysis of variance. Important aspects include estimation of the percentages of variance that can be explained by different environmental factors, and the coefficients of correlation and statistical significance (P-value) of the different relationships. The statistical tests to be used should be taken into account at the stage of designing the fieldwork programme – regression designs are often more powerful than ANOVA designs. Numbers of replicates should be maximised in order to strengthen the statistical power of the conclusions that can be drawn from the data collected.

### 8.3 Strengths and weaknesses

The major strength of *in situ* studies is the inclusion of natural environmental variability that is difficult or impossible to capture in laboratory experiments. Thus, the performance of organisms or processes of interest measured during *in situ* experiments may represent more accurately natural patterns that may not be evident

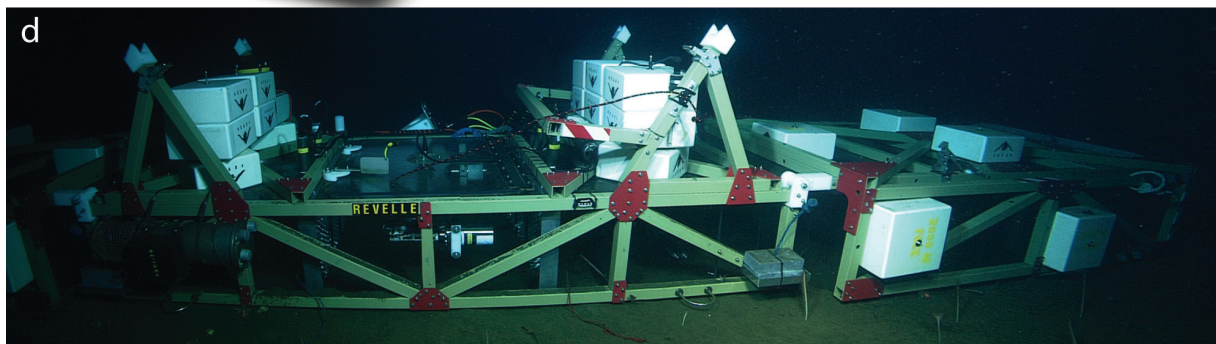
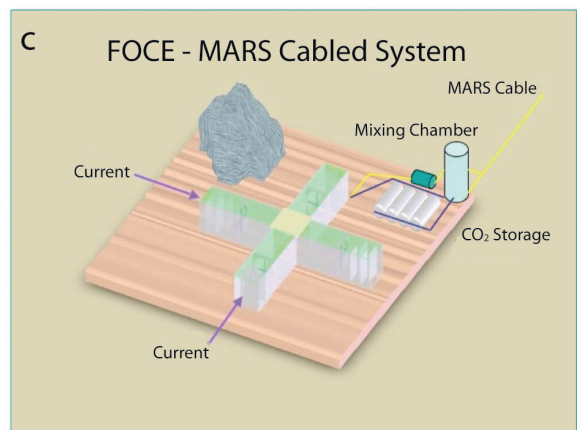
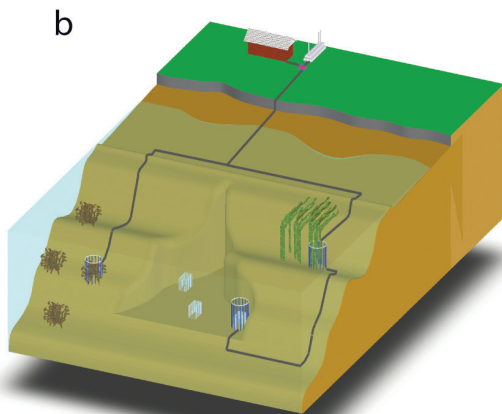
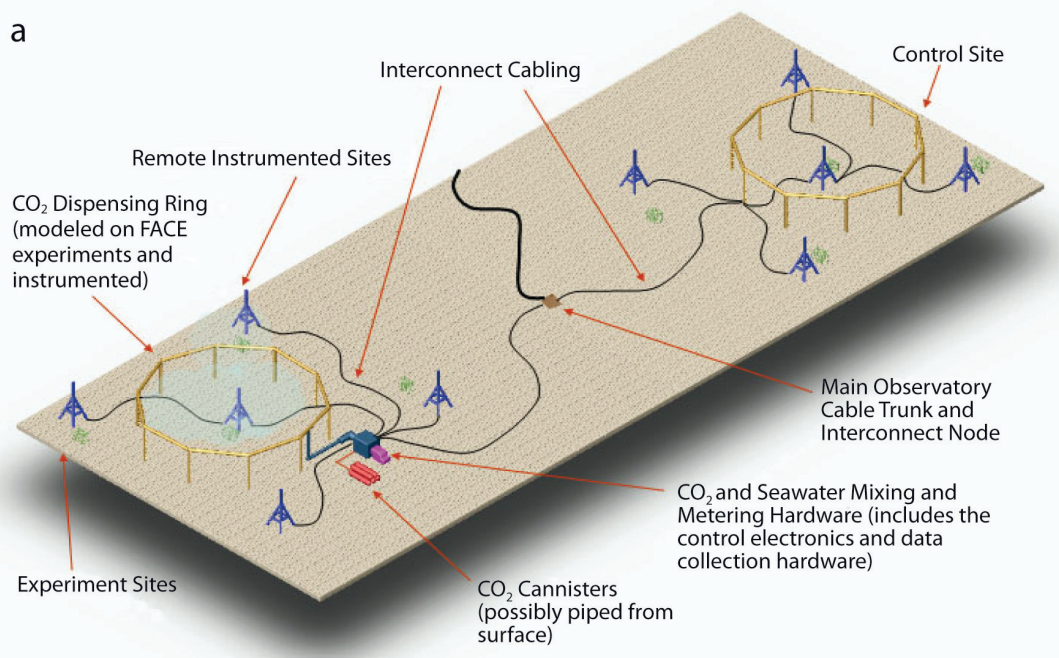

**Figure 8.3** Free Ocean CO<sub>2</sub> Enrichment (FOCE) concepts and prototype. a. FOCE concept drawing with design analogous to FACE (Free Air CO<sub>2</sub> Enrichment) designs with coarse CO<sub>2</sub> plumbing and upstream CO<sub>2</sub> injection. b. FOCE concept for nearshore systems with shore-based supply and control stations leading to offshore FOCE plumbing frames. c. FOCE prototype design for connection to the Monterey Accelerated Research System (MARS) submarine cabled observatory. This system uses a flume design allowing flow into a control volume along 2 axes. d. Photograph of FOCE prototype at 900 m depth off Central California, attached for testing to the MARS cable system. Flow is along 1 axis, with a central control volume (behind “Revelle” label), flotation blocks (white blocks) for deployment/recovery, and a mixing zone in the upstream and downstream ends. (W. Kirkwood & MBARI).

in controlled laboratory experiments. For natural gradients or venting sites, the spatial and temporal scales can be very large, thereby allowing investigators to examine patterns and processes over large areas, and include response variables that require long-term responses to ocean acidification. For example, the nearly pure CO<sub>2</sub> venting sites bordering Ischia have persisted for long periods, allowing the natural assemblage to acclimate and adjust to the local effects of ocean acidification, resulting in the observed community patterns. Coupling such studies with controlled *in situ* or laboratory experiments can add greater inferential power to ocean acidification studies.

Another major strength is the ability of *in situ* studies to improve our understanding or gain information concerning the indirect and direct effects of ocean acidification. For instance, 8 years of monitoring of species occupancy at >1700 neighbouring rocky-shore locations found that most calcifiers fared poorly at low pH, but that some increased their presence (Wootton *et al.*, 2008). The authors speculated that some calcareous sessile species appeared to benefit from ocean acidification due to: (1) stronger effects of ocean acidification on the dominant calcareous species with which they compete for habitat space, or (2) suppression of calcareous predators (e.g. calcareous crabs preying on calcareous mussels). Another example of an indirect effect of acidification difficult to detect on a community level using laboratory experiments is the improved growth of seagrasses at low pH observed at Ischia (Hall-Spencer *et al.*, 2008), due to reduction in their epiphytic load (reduced amounts of crustose calcareous algae growing on their leaves).

The realism of *in situ* studies can also be a weakness; natural environmental conditions often lead to variation in response variables (e.g. survival, behaviour, growth etc.), due both to treatment effects and uncontrolled natural processes. See chapter 7 for a broader discussion of laboratory and shallow water mesocosm studies. In turn, higher variability may reduce the inferential power of *in situ* experiments, in which replication is often limited due to logistic constraints. And although *in situ* observational studies are capable of providing strong evidence concerning the indirect consequences of ocean acidification, the role of direct versus indirect effects may be obscure. For example, are the pH-related patterns in biological assemblages near Ischia (Hall-Spencer *et al.*, 2008) caused directly by the intolerance of larvae, juveniles, and/or adults among species, or perhaps indirectly through pH-related changes in densities of important predators and competitors? Nor may the effects of localised variation in pH and p(CO<sub>2</sub>) near venting sites reflect the eventual patterns arising from the global-scale acidification of the oceans (Riebesell, 2008). For instance, immigration of adult organisms into a vent site after passing their most sensitive early life stages elsewhere may give a false impression of tolerance. Only a subset of the regional population for each species will be impacted, placing in question the influence of ocean acidification on the population dynamics for the species. In addition, temporal variation in pH may lead to spurious conclusions concerning the effects of chronic, long-term, and relatively invariant changes in pH.

Confounding factors, particularly for observational studies where control of ocean acidification treatments is minimal, may have large effects that could be confused with or attributed to pH or p(CO<sub>2</sub>). For example, natural venting sites often have high levels of methane, sulfide, metals, and possibly hypoxic waters (Kelley *et al.*, 2002) as well as high temperatures, each with potentially important effects. For studies concerning the effects of ocean acidification along depth-related or other spatial gradients in pH, several other factors must also be considered (e.g. oxygen, pressure, temperature, nutrients, light).

Manipulative experiments have greater inferential power than observational studies and other natural experiments. These methods may best be used together to determine more explicitly the effects of ocean acidification. Finally, studies using natural gradients in carbonate chemistry, particularly localised CO<sub>2</sub> vents, may have limited opportunities for replication and interspersions of replicates among treatments. Some strengths and weaknesses of *in situ* experiments are listed in Table 8.1.

**Table 8.1** Estimates of the strengths and weaknesses of *in situ* ocean acidification experiments. Plus symbols indicate strengths. Minus signs indicate weaknesses.

Strengths and weaknesses	Observational studies	Controlled experiments
Natural realism	++++	+++
Effects on individuals	+++	+++
Population and community effects	++++	+/-
Acute effects	+++	+++
Chronic effects	++++	---
Adaptation	+++	---
Direct effects	++	++
Indirect effects	++	?
Multiple stresses	---	+/-
Confounding factors	---	++
Randomisation	---	+++
Replication	+/-	+++
Control over carbonate system factors	+/--	+++

### 8.4 Potential pitfalls

*In situ* observations and experiments allow investigators to assess the effects of ocean acidification in natural ecosystems, but have limitations in both design and technology that should be considered carefully. These include:

- Stability of carbonate system parameters – for *in situ* observational studies and controlled manipulations variation in ocean acidification treatments (e.g. pH) may be considerable, thereby obscuring the effects of mean, versus extreme, changes in pH.
- For controlled experiments, the short-term response of organisms or populations may not represent gradual or chronic effects.
- Measurement and monitoring of carbonate system parameters during *in situ* experiments may be technically difficult.
- The effects of confounding factors with pH or other carbonate system parameters may be large.
- Scaling up from individual responses (or physiological effects) to communities/ecosystems may be difficult.

## 8.5 Suggestions for improvement

*In situ* ocean acidification studies will benefit from improved technology to enable controlled perturbation experiments, including FOCE-type or chamber systems with CO<sub>2</sub> control, sensors for accurate, long-term, *in situ* measurements of ocean carbonate system parameters (see chapter 1), and from the discovery of new natural vent sites releasing nearly pure CO<sub>2</sub>. Presently, the technology to control pH or p(CO<sub>2</sub>) under field conditions is very limited, and restricts progress in understanding the effects of future ocean acidification under natural conditions. Recent advances in field effect transistor (FET) pH sensors (e.g. Honeywell durafet pH sensor) have promise for long term stability and accuracy, but are not yet widely available for *in situ* deployments. Other parameters of the carbonate system remain more difficult to measure *in situ*, particularly for long-term automated measurements. Observational studies should aim to measure more than 2 carbon parameters, so as to over-constrain the carbonate chemistry (chapter 1). See chapter 2 for a discussion of methods to control the seawater carbonate system parameters.

Considering the technical difficulty of performing CO<sub>2</sub> perturbation experiments under field conditions, the carbon dioxide venting areas off Ischia (Hall-Spencer *et al.*, 2008) and other natural gradients in ocean carbonate chemistry are important discoveries for ocean acidification studies, due to their value as natural laboratories. Though limited in spatial extent, conditions at the Ischia site will enable a variety of hypotheses concerning the effects of ocean acidification to be tested with controlled experiments. Discovery of additional venting sites or other natural gradients in carbonate chemistry in various ocean settings will also be useful for *in situ* observational studies, and can be combined with tests of specific hypotheses using manipulative experiments in the laboratory or *in situ* to advance understanding of the potential consequences of future ocean acidification.

## 8.6 Data reporting

Experimental studies concerning natural gradients in ocean pH or controlled *in situ* perturbations should include a clear explanation of the design, treatment levels for carbonate system parameters, potentially confounding factors, and response variables. It is beyond the scope of this chapter to consider the breadth of response variables that may be relevant for ocean acidification studies. However, the design of the experiment (e.g. ANOVA, regression etc.), including treatment levels for carbonate system parameters, layout of treatments and replicates, and a comprehensive list of all measurements (when and where), should be reported. For natural gradients in pH or other carbonate system parameters, potential limitations of the design (e.g. lack of interspersed or replication, temporal and spatial variability etc.) should also be reported and discussed. Seawater carbonate parameters in addition to pH should be reported, if possible, including the mean and range of variation for each parameter within each treatment. Where possible, potentially confounding factors (e.g. methane, sulfide, temperature, oxygen) should also be monitored and reported.

## 8.7 Recommendations for standards and guidelines

1. Consider the analytical design of the experiment before any fieldwork begins – regression designs are often more powerful than ANOVA designs.
2. Replicate treatments and intersperse replicates among treatments (see chapter 4).
3. Repeat experiments, if possible.
4. Measure multiple carbonate system parameters, if possible (see chapter 1).
5. Strive to reduce the variability in pH or other carbonate system parameters within treatments, to provide controlled, unambiguous treatment levels.

6. Monitor pH and other parameters throughout the experiment to determine their spatial and temporal variability within each treatment (see chapter 1).
7. Measure potentially confounding factors that may also influence response variables.
8. If possible, design experiments to include the influence and interaction among multiple factors in addition to carbonate system parameters (e.g. temperature, light, nutrients, hypoxia).

### 8.8 References

- Ainsworth E. A. & Long S. P., 2005. What have we learned from 15 years of free-air CO<sub>2</sub> enrichment (FACE)? A meta-analytic review of the responses of photosynthesis, canopy properties and plant production to rising CO<sub>2</sub>. *New Phytologist* 165:351-371.
- Andersson A. J., Bates N. R. & Mackenzie F. T., 2007. Dissolution of carbonate sediments under rising pCO<sub>2</sub> and ocean acidification: observations from Devil's Hole, Bermuda. *Aquatic Geochemistry* 13:237-264.
- Barry J. P., Buck K. R., Lovera C., Kuhnz L. & Whaling P. J., 2005. Utility of deep sea CO<sub>2</sub> release experiments in understanding the biology of a high-CO<sub>2</sub> ocean: Effects of hypercapnia on deep sea meiofauna. *Journal of Geophysical Research- Oceans* 110, C09S12. doi:10.1029/2004JC002629.
- Barry J. P., Buck K. R., Lovera C. F., Kuhnz L., Whaling P. J., Peltzer E. T., Walz P. & Brewer P. G., 2004. Effects of direct ocean CO<sub>2</sub> injection on deep-sea meiofauna. *Journal of Oceanography* 60:759-766.
- Bensoussan N. & Gattuso J.-P., 2007. Community primary production and calcification in a NW Mediterranean ecosystem dominated by calcareous macroalgae. *Marine Ecology Progress Series* 334:37-45.
- Brewer P. G., Peltzer E. T. & Rehder G., 2001. Experiments on the deep ocean disposal of fossil fuel CO<sub>2</sub>. *Eos, Transactions of the American Geophysical Union* 82:U32B-05.
- Cooper T. F., De'ath G., Fabricius K. E. & Lough J., 2008. Declining coral calcification in massive Porites in two nearshore regions of the northern Great Barrier Reef. *Global Change Biology* 14:529-538.
- Fabry V. J., Seibel B. A., Feely R. A. & Orr J. C., 2008. Impacts of ocean acidification on marine fauna and ecosystem processes. *ICES Journal of Marine Science* 65:414-432.
- Findlay H. S., Tyrrell T., Bellerby R. G. J., Merico A. & Skjelvan I., 2008. Carbon and nutrient mixed layer dynamics in the Norwegian Sea. *Biogeosciences* 5:1395-1410.
- Fleeger J. W., Carman K. R., Welsenhorn P. B., Sofranko H., Marshall T., Thistle D. & Barry J. P., 2006. Simulated sequestration of anthropogenic carbon dioxide at a deep-sea site: Effects on nematode abundance and biovolume. *Deep-Sea Research I* 53:1135-1147.
- Grassle J. F., 1985. Hydrothermal vent animals - distribution and biology. *Science* 229:713-717.
- Guinotte J. M., Orr J., Cairns S., Freiwald A., Morgan L. & George R., 2006. Will human-induced changes in seawater chemistry alter the distribution of deep-sea scleractinian corals? *Frontiers in Ecology and the Environment* 4:141-146.
- Hall-Spencer J. M., Rodolfo-Metalpa R., Martin S., Ransome E., Fine M., Turner S. M., Rowley S. J., Tedesco D. & Buia M.-C., 2008. Volcanic carbon dioxide vents show ecosystem effects of ocean acidification. *Nature* 454:96-99.
- Hönisch B. & Hemming N. G., 2005. Surface ocean pH response to variations in pCO<sub>2</sub> through two full glacial cycles. *Earth and Planetary Science Letters* 236:305-314.
- Iglesias-Rodriguez M. D., Halloran P. R., Rickaby R. E. M., Hall I. R., Colmenero-Hidalgo E., Gittins J. R., Green D. R. H., Tyrrell T., Gibbs S. J., von Dassow P., Rehm E., Armbrust E. V. & Boessenkool K. P., 2008. Phytoplankton calcification in a high-CO<sub>2</sub> world. *Science* 320:336-340.



- Inagaki F., Kuypers M. M. M., Tsunogai U., Ishibashi J., Nakamura K., Treude T., Ohkubo S., Nakaseama M., Gena K., Chiba H., Hirayama H., Nunoura T., Takai K., Jørgensen B. B., Horikoshi K. & Boetius A., 2006. Microbial community in a sediment-hosted CO<sub>2</sub> lake of the southern Okinawa Trough hydrothermal system. *Proceedings of the National Academy of Science U.S.A.* 103:14164-14169.
- Ishida H., Watanabe Y., Fukuhara T., Kaneko S., Furusawa K. & Shirayama Y., 2005. *In situ* enclosure experiment using a benthic chamber system to assess the effect of high concentration of CO<sub>2</sub> on deep-sea benthic communities. *Journal of Oceanography* 61:835-843.
- Kelley D. S., Baross J. A. & Delaney J. R., 2002. Volcanoes, fluids, and life at mid-ocean ridge spreading centers. *Annual Review of Earth and Planetary Sciences* 30:385-491.
- Kleypas J. A., McManus J. W. & Meñez L. A. B., 1999. Environmental limits to coral reef development: where do we draw the line? *American Zoologist* 39:146-159.
- Manzello D. P., Kleypas J. A., Budd D. A., Eakin C. M., Glynn P. W. & Langdon C., 2008. Poorly cemented coral reefs of the eastern tropical Pacific: possible insights into reef development in a high-CO<sub>2</sub> world. *Proceedings of the National Academy of Science U.S.A.* 105:10450-10455.
- Marshall D. J., Santos J. H., Leung K. M. Y. & Chak W. H., 2008. Correlations between gastropod shell dissolution and water chemical properties in a tropical estuary. *Marine Environmental Research* 66:422-429.
- Martin S., Rodolfo-Metalpa R., Ransome E., Rowley S., Gattuso J.-P. & Hall-spencer J., 2008. Effects of naturally acidified seawater on seagrass calcareous epibionts. *Biology Letters* 4:689-692.
- Orr J. C., Fabry V. J., Aumont O., Bopp L., Doney S. C., Feely R. A., Gnanadesikan A., Gruber N., Ishida A., Joos F., Key R. M., Lindsay K., Maier-Reimer E., Matear R., Monfray P., Mouchet A., Najjar R. G., Plattner G. K., Rodgers K. B., Sabine C. L., Sarmiento J. L., Schlitzer R., Slater R. D., Totterdell I. J., Weirig M. F., Yamanaka Y. & Yool A., 2005. Anthropogenic ocean acidification over the twenty-first century and its impact on calcifying organisms. *Nature* 437:681-686.
- Riebesell U., 2008. Acid test for marine biodiversity. *Nature* 454:46-47.
- Riebesell U., Zondervan I., Rost B., Tortell P. D. & Morel F. M. M., 2000. Reduced calcification of marine plankton in response to increased atmospheric CO<sub>2</sub>. *Nature* 407:364-367.
- Rodolfo-Metalpa R., Lombardi C., Cocito S., Hall-Spencer J. M. & Gambi M. C., in press. Effects of ocean acidification and high temperatures on the bryozoan *Myriapora truncata* at natural CO<sub>2</sub> vents. *Marine Ecology*.
- Rost B., Zondervan I. & Wolf-Gladrow D., 2008. Sensitivity of phytoplankton to future changes in ocean carbonate chemistry: current knowledge, contradictions and research directions. *Marine Ecology Progress Series* 373:227-237.
- Tamburri M. N., Peltzer E. T., Friederich G. E., Aya I., Yamane K. & Brewer P. G., 2000. A field study of the effects of CO<sub>2</sub> ocean disposal on mobile deep-sea animals. *Marine Chemistry* 72:95-101.
- Thistle D., Carman K. R., Sedlacek L., Brewer P. G., Fleeger J. W. & Barry J. P., 2005. Deep-ocean, sediment-dwelling animals are sensitive to sequestered carbon dioxide. *Marine Ecology Progress Series* 289:1-4.
- Tortell P. D., Payne C., Gueguen C., Strzepek R. F., Boyd P. W. & Rost B., 2008. Inorganic carbon uptake by Southern Ocean phytoplankton. *Limnology and Oceanography* 53:1266-1278.
- Tunnicliffe V., Davies K. T. A., Butterfield D. A., Embley R. W., Rose J. M. & Chadwick W. W., Jr., 2009. Survival of mussels in extremely acidic waters on a submarine volcano. *Nature Geoscience* 2:344-348.
- Tyrrell T., Schneider B., Charalampopoulou A. & Riebesell U., 2008. Coccolithophores and calcite saturation state in the Baltic and Black Seas. *Biogeosciences* 5:485-494.
- Van Dover C. L., 2000. *The ecology of deep-sea hydrothermal vents*. 424 p. Princeton: Princeton University Press.

## Part 2: Experimental design of perturbation experiments

- Vetter E. W. & Smith C. R., 2005. Insights into the ecological effects of deep ocean CO<sub>2</sub> enrichment: the impacts of natural CO<sub>2</sub> venting at Loihi seamount on deep sea scavengers. *Journal of Geophysical Research- Oceans* 110, C09S13. doi:10.1029/2004JC002617.
- Walz P. M., Kirkwood W. J., Peltzer E. T., Hester K. C. & Brewer P. G., 2008. Creating controlled CO<sub>2</sub> perturbation experiments on the seafloor - development of FOCE techniques. *Proceedings of the Marine Technology Society / Institute of Electrical and Electronics Engineers Kobe Techno-Ocean* 1:1-4.
- Wootton J. T., Pfister C. A. & Forester J. D., 2008. Dynamic patterns and ecological impacts of declining ocean pH in a high-resolution multi-year dataset. *Proceedings of the National Academy of Science U.S.A.* 105:18848-18853.

### 9 Studies of acid-base status and regulation

Hans-Otto Pörtner<sup>1</sup>, Ulf Bickmeyer<sup>1</sup>, Markus Bleich<sup>2</sup>, Christian Bock<sup>1</sup>, Colin Brownlee<sup>3</sup>, Frank Melzner<sup>4</sup>, Basile Michaelidis<sup>5</sup>, Franz-Josef Sartoris<sup>1</sup> and Daniela Storch<sup>1</sup>

<sup>1</sup>Alfred Wegener Institute for Polar and Marine Research, Germany

<sup>2</sup>Institute of Physiology, Christian-Albrechts-University, Germany

<sup>3</sup>Marine Biological Association, UK

<sup>4</sup>Leibniz-Institute of Marine Sciences, IFM-GEOMAR, Germany

<sup>5</sup>School of Biology, Aristotle University of Thessaloniki, Greece

#### 9.1 Introduction

The emerging threat of ocean acidification for marine life has re-emphasised the crucial importance of acid-base status and regulation in whole organism functional maintenance and enantiostasis. pH values in different body compartments are widely accepted to play a key role in the maintenance of physiological function or their limitation under functional or environmental stress. pH affects protein function in metabolism and oxygen transport. Also, acid-base and metabolic regulation are interdependent processes in a way that changes in pH affect metabolic rate, the mode of catabolism and energetic parameters (Pörtner, 1989).

However, acid-base regulation not only means adjustment or maintenance of pH which, in turn, is perceived as the key acid-base parameter influencing regulatory processes. Under certain conditions and with the help of the respective membrane carriers (see below), priority may rather be given to the regulation of the concentrations of bases (carbonate, bicarbonate) or acid (carbonic acid, which is proportional to CO<sub>2</sub> partial pressure) in body fluids. pH then becomes a dependent variable. Also, in some studies, it is not pH which is of interest but rather the activity of protons  $a_{\text{H}^+}$ ,  $\text{pH} = -\log_{10}(a_{\text{H}^+})$ , for example when protons contribute to some biochemical reactions or affect protein carriers in a concentration dependent manner (see equation 9.1, as an example). In general, biochemical studies of acid-base regulation usually focus on intracellular pH as a key parameter related to protein function, whereas physiological, cellular and especially whole animal studies have always considered the close interrelationships between pH and the CO<sub>2</sub>/bicarbonate system in intra- and extracellular fluids (Siggaard-Andersen, 1974). Furthermore, the involvement of CO<sub>2</sub> and bicarbonate as substrates or products in enzymatic reactions (Pörtner, 1989; Walsh & Milligan, 1989; Hardewig *et al.*, 1994) led to the development of physiological concepts of acid-base regulation in metabolic biochemistry.

Acid-base regulation is an energy dependent process since some of the acid-base equivalents are transported by H<sup>+</sup>-ATPases or by processes exploiting the Na<sup>+</sup>-gradient established by Na<sup>+</sup>/K<sup>+</sup>-ATPase, for example Na<sup>+</sup>/H<sup>+</sup> or sodium dependent Cl<sup>-</sup>/HCO<sub>3</sub><sup>-</sup> exchangers. Species are capable of modulating the cost of acid-base regulation. Conversely, the rate and efficiency of acid-base regulation are influenced by the value of pH that is reached or that can be maintained by the ion exchange mechanisms involved in regulation (e.g. Reipschläger & Pörtner, 1996; Pörtner *et al.*, 2000). In addition, the significance of metabolism for acid-base regulation has been discussed, from disturbances of acid-base status to metabolic contributions to acid-base regulation, with some ongoing debate (Hochachka & Mommsen, 1983; Pörtner, 1987a, 1995; Atkinson & Bourke, 1995; Robergs *et al.*, 2004, Prakash *et al.*, 2008). Quantifying acid-base parameters *per se* remains insufficient to gain a deeper understanding of the ecological role of acid-base physiology. This requires addressing the effects of acid-base variables on metabolic processes and species performances (e.g. exercise, growth, shell structure and calcification, reproduction) and fitness. Such relationships have rarely been investigated. Most importantly, changes in acid-base variables in the organism should be considered as mediators of effects and not just as effects *per se* (Pörtner *et al.*, 2005).

### 9.2 Fundamentals of acid-base regulation

#### 9.2.1 A comprehensive set of acid-base parameters in whole organism research

Acid-base regulation occurs at systemic (extracellular), cellular and subcellular levels. For unicellular marine organisms, seawater is the extracellular fluid. In animals, the composition of seawater has been modified into the ones of haemolymph, coelomic fluid, interstitial fluid and blood. For ocean acidification research, acid-base parameters should ideally be determined in relevant compartments of whole organisms and in conditions as close as possible to their natural situation (for example animals dwelling in burrows), or in animals during and after exercise. As a trade-off, analyses may need to be carried out in isolated organs or cellular preparations of organisms acclimated to CO<sub>2</sub> levels according to ocean acidification scenarios. Acclimation would ideally be long term (weeks or months), possibly followed by analyses of short-term modifications (seconds to minutes), for example during study of muscular activity under elevated CO<sub>2</sub> levels. During studies in live animals, development of a quantitative picture of acid-base status should include parallel analyses of acid-base parameters in both intra- and extracellular fluids as well as in ambient water. This includes measurement of pH, P<sub>CO<sub>2</sub></sub> and the concentrations of bicarbonate and carbonate in the compartments of interest. Furthermore, the buffer value of non-bicarbonate buffers resisting such changes by proton binding or release must also be known. Such quantification of acid-base variables will reveal the net movement of acid-base equivalents between compartments, across membranes or epithelia (cf. Heisler, 1989). In the context of ocean acidification and ocean warming it needs to be considered that regulated set points of acid-base regulation are not invariant, but are dynamic depending on the physiological condition of the organism and are, moreover, influenced by ambient parameters such as temperature and CO<sub>2</sub>.

Reeves (1972, 1985) introduced the imidazole  $\alpha$ -stat hypothesis stating that poikilotherms regulate pH such that the degree of protonation ( $\alpha$ ) of imidazole groups is maintained despite changes in body temperature. The importance of this concept is emphasised by the observation that the average pK of histidyl residues exposed to the solvent falls in the vicinity of pH<sub>i</sub> values of typical cells (Somero, 1986). Thus, relatively small changes in pK<sub>i</sub> could produce significant changes in protein ionisation. The  $\alpha$ -stat concept implies that changes in pH fully or partly offset temperature-induced changes in protein ionisation thereby maintaining relative constancy of protein structure and function. Since the pK of imidazole groups may (on average) change by  $-0.018^\circ\text{C}^{-1}$ , a shift in intra- and extracellular pH with body temperature by  $\Delta\text{pH}/\Delta T \sim -0.018^\circ\text{C}^{-1}$  enables  $\alpha$  to remain constant.  $\alpha$ -stat pH regulation is also beneficial for the energy status. A pH rise with falling temperature ensures that the ATP free energy is maintained at a high level (Pörtner *et al.*, 1998). Cameron (1989) proposed the “Z-stat” model which emphasises that protein net charge Z is maintained rather than  $\alpha$  in diverse histidine groups. Z-stat is a consequence of the maintenance of mean  $\alpha$  for any protein mixture.  $\Delta\text{pK } ^\circ\text{C}^{-1}$  depends upon local charge configurations in the environment of the imidazole group as well as on ionic strength and, therefore, varies between  $-0.016$  and  $-0.024^\circ\text{C}^{-1}$  for histidine and free imidazole compounds and ranges between  $-0.001$  and  $-0.051^\circ\text{C}^{-1}$  for histidine residues in proteins (Heisler, 1986). Overall, pH changes with temperature in marine ectotherms support the concept but can deviate from the theoretical value of  $-0.018^\circ\text{C}^{-1}$  depending on the physiological situation of the organism (cf. Pörtner *et al.*, 1998).

#### 9.2.2 Physicochemistry of body fluids: pH bicarbonate analysis

It is crucial that analyses of compartmental physicochemistry quantify the acid-base parameters, which are affecting the components and thermodynamics of biological processes in a concentration-dependent manner. These parameters usually include the free concentrations or activities of solutes such as CO<sub>2</sub>, protons, bicarbonate and/or carbonate ions. The disturbance of body and cell compartments by elevated CO<sub>2</sub> levels also depends on the concentration and characteristics of buffers (e.g. phosphates, imidazole groups in proteins and amino acids), summarised as the non-bicarbonate buffer value  $\beta_{\text{NB}}$  (mmol H<sup>+</sup> l<sup>-1</sup> pH<sup>-1</sup>). pH in body fluids has traditionally been determined on the NBS pH scale using IUPAC high precision buffers (e.g. Buck *et*

*al.*, 2002). For pH analyses in seawater, ocean chemists have developed specific procedures and buffers in line with different pH scales; the free, total and seawater pH scales (Zeebe & Wolf-Gladrow, 2001; chapter 1 of this guide). The issue of how ocean physicochemistry impacts on marine organisms requires bringing the oceanographic and physiological approaches together. The inclusion of sulfate protonation equilibria into the total pH scale and of both sulfate and fluoride protonation into the seawater pH scale enhances the precision in quantifying changes in ocean physicochemistry. However, this inclusion means that the total and seawater scales do not represent the pH effective on biological material. Dissociation equilibria depend on ionic strength and on proton activity (cf. Pörtner, 1990). When studying effects of seawater pH on function in marine invertebrates, the free pH scale (which excludes protons bound to sulfate and fluoride) thus appears most suitable. The dissociation equilibria of sulfate and fluoride, which are included in the total and seawater pH scales, respectively, are pH-dependent variables and do not interfere or interact with the pH-dependent protonation of biological material. Since seawater buffers are set to calibrate electrodes on total scale, free pH must be determined from total pH by calculation.

The ionic strength of extracellular invertebrate body fluids is similar to the ionic strength of seawater. The use of the free pH scale in both seawater and invertebrate extracellular fluid would support comparing the pH values in both fluids and accurately quantifying the pH gradients between them. The calibration on total scale involves the use of appropriate buffers at seawater ionic strength. This would reduce the errors introduced by shifting liquid junction potentials of pH electrodes when calibrating and measuring solutions of largely different ionic strengths (Dickson *et al.*, 2007). Marine organisms also enter estuaries or brackish waters with variable osmolarities. Precise measurements of pH in their body fluids benefit from the use of buffers with the corresponding ionic composition and strength. Recipes and equations for the preparation of such synthetic seawater buffer solutions of different salinities (using Tris/HCl and 2-aminopyridine/HCl) are available in Dickson *et al.* (2007) (Chapter SOP 6a).

However, the use of the NBS pH scale in both seawater and extracellular fluid would still quantify pH gradients correctly, although absolute pH values differ somewhat from those on the free scale. In general, the use of the NBS pH scale for body fluids allows the use of well-established physiological concepts and methodologies (see below). In both invertebrates and fish tissues, or in all body fluids of marine teleost fishes, the NBS scale appears the most appropriate at present, due to ionic concentrations and osmolarities similarly low as in mammalian tissues and body fluids. The same likely applies to marine invertebrate osmoconformers living in brackish water. In any case, measuring relative pH changes over time within one compartment requires using the same calibration method throughout. In the future, a continuum of pH calibrations at various ionic strengths would help to bring ocean chemists and biologists together to address the acid-base physiology of marine organisms in response to ocean acidification. In the following, all pH values refer to the NBS scale. Measurements in the extracellular fluids of marine invertebrates or seawater involve the use of pH electrodes equilibrated in seawater prior to calibration and also prior to the actual analyses in body fluids.

The pH/bicarbonate diagram, also called Davenport-diagram (Figure 9.1) quantifies respiratory (via changes in  $P_{\text{CO}_2}$ ) and non-respiratory processes contributing to changes in the acid-base status. Non-respiratory changes in a compartment comprise the influence of metabolic pathways and the net exchange of acid or base equivalents across epithelia or membranes. Also included in the non-respiratory processes are any changes in the protonation of proteins associated with the binding or release of ligands (e.g. oxygen binding or release from haemoglobin or haemocyanin, cf. Pörtner, 1990b). The pH/bicarbonate diagram illustrates the relationships between pH, bicarbonate concentrations and  $P_{\text{CO}_2}$  as they result from the Henderson-Hasselbalch-equation of the  $\text{CO}_2$ /bicarbonate system (Figure 9.2). The analysis of the acid-base status quantifies the changes in pH, bicarbonate concentration,  $P_{\text{CO}_2}$ , and non-bicarbonate buffer value  $\beta_{\text{NB}}$  in the various compartments. The total (tot.) change in pH comprises a respiratory (resp.) and a non-respiratory (non-resp.) component. The respiratory component of the pH change is derived from the change in  $P_{\text{CO}_2}$  along the buffer line, in accordance with the titration of the non-bicarbonate buffer mix by  $\text{CO}_2$ . This process leads to changes in pH and in bicarbonate levels in opposite direction (pH falls and the bicarbonate level rises). Accordingly, respiratory proton quantities are determined

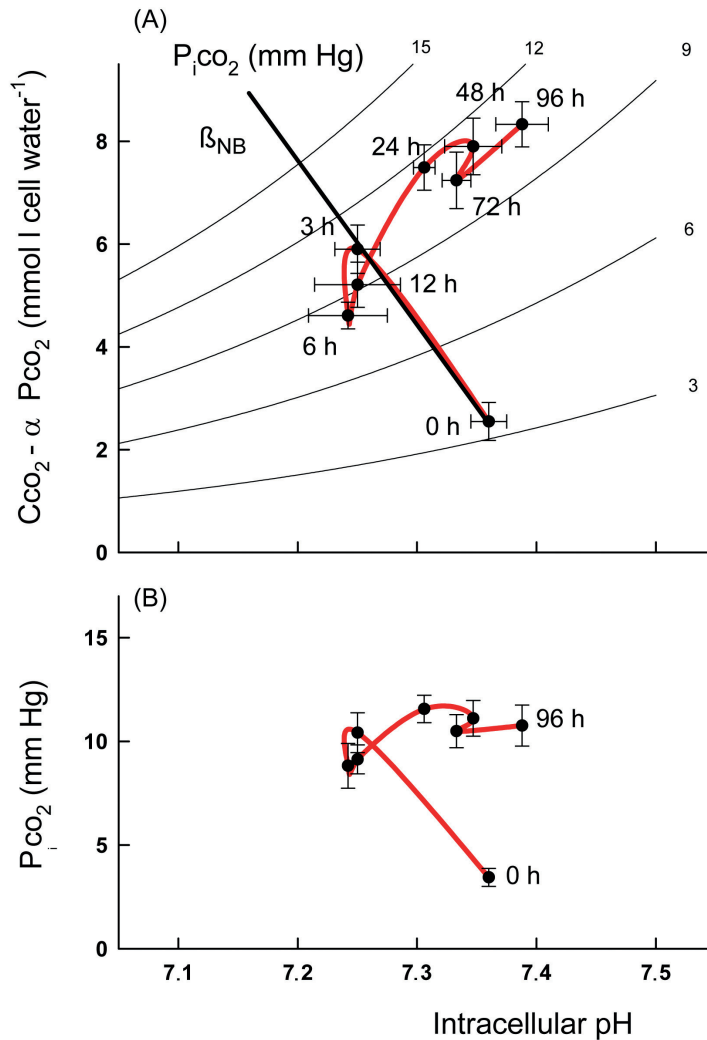

**Figure 9.1** pH bicarbonate diagram (A) depicting the interrelated changes of intracellular acid-base variables pH (pH<sub>i</sub>), bicarbonate and Pco<sub>2</sub> (P<sub>i</sub>CO<sub>2</sub>) over time and in relation to the non-bicarbonate buffer (β<sub>NB</sub>) line. Initial changes in pH<sub>i</sub> are driven by the accumulation of CO<sub>2</sub> which leads to a rise in Pco<sub>2</sub> (B), titrates non-bicarbonate buffers and is therefore paralleled by an accumulation of bicarbonate (A). Transmembrane ion exchange and metabolic processes interfere after 3 h and, after an initial base loss, lead to continued net bicarbonate accumulation while the respiratory acidosis persists with more or less constant P<sub>i</sub>CO<sub>2</sub> levels (based on data from Pörtner *et al.*, 1998).

during pH/bicarbonate analysis as the bicarbonate increment along the buffer line β<sub>NB</sub>, starting from a control point specified by a combination of pH, bicarbonate and Pco<sub>2</sub> values (equation 9.1).

$$\Delta\text{pH}_{\text{resp.}} \times -|\beta_{\text{NB}}| = \Delta[\text{HCO}_3^-]_{\text{resp.}} = -\Delta\text{H}^+_{\text{resp.}} \quad (9.1)$$

In contrast, non-respiratory changes in the acid-base status cause a unidirectional change in both pH and bicarbonate levels (Figure 9.1B). It follows one of the Pco<sub>2</sub> isopleths starting from a control point in the graph defined by pH, bicarbonate and Pco<sub>2</sub>. The respective proton quantities causing such changes are calculated from the changes in pH and bicarbonate concentration along the Pco<sub>2</sub> isopleth considering the non-bicarbonate buffer value (equation 9.2).

$$\Delta\text{H}^+_{\text{non-resp.}} = \left( \Delta\text{pH}_{\text{tot.}} \times -|\beta_{\text{NB}}| \right) - \Delta[\text{HCO}_3^-]_{\text{tot.}} \quad (9.2)$$

Usually, a change in acid-base status is caused by a mix of respiratory and non-respiratory disturbances. Equation 9.2 is still valid when the change in pH and bicarbonate concentration are affected by respiratory processes, indicated by a change in  $P_{CO_2}$ . The dissolution of carbonates is also taken into account through its effects on pH and on the concentration of bicarbonate. Since a respiratory change in pH is associated with a change in bicarbonate levels in the opposite direction (equation 9.1), respiratory changes always balance to 0 in equation 9.2.

### 9.3 Measurement of pH, total $CO_2$ and non-bicarbonate buffer values

For optimal cellular function, intracellular pH ( $pH_i$ ) is tightly controlled particularly within the cytosol, through the effect of mechanisms such as intracellular buffering and membrane transport (including ATP-driven  $H^+$  pumps, exchangers and ion channels).  $H^+$  gradients maintained between the intracellular and extracellular spaces are used for membrane transport of substrates and ions, e.g. dipeptides (Daniel & Kottra, 2004) and  $Na^+$  (Biemesderfer *et al.*, 1993). Understanding the mechanisms that regulate intracellular pH is a prerequisite for estimating the effects of long-term pH perturbations on pH-dependent intracellular processes. For a meaningful interpretation of the impact of ocean acidification on marine organisms (Pörtner *et al.*, 2005) measurements of intracellular pH require the knowledge of extracellular pH ( $pH_e$ ). The maintenance of extracellular pH is a highly dynamic process, which feeds back on the regulation of  $pH_i$  (Pörtner *et al.*, 2000). Thus, a comparison of intracellular pH between systems is meaningless without knowledge of  $pH_e$  (Gillies *et al.*, 1994).

$$\begin{array}{c}
 \overbrace{\text{CO}_2 + \text{H}_2\text{O} \leftrightarrow \text{H}_2\text{CO}_3}^{\text{A}} \leftrightarrow \text{H}^+ + \text{HCO}_3^- \leftrightarrow \text{H}^+ + \text{HCO}_3^- \leftrightarrow \text{H}^+ + \text{HCO}_3^- \leftrightarrow \text{H}^+ + \text{HCO}_3^- \\
 \underbrace{\text{H}^+ + \text{HCO}_3^-}_{\text{B}} \leftrightarrow \text{H}_2\text{CO}_3 \leftrightarrow \text{H}^+ + \text{HCO}_3^- \leftrightarrow \text{H}^+ + \text{HCO}_3^- \leftrightarrow \text{H}^+ + \text{HCO}_3^- \leftrightarrow \text{H}^+ + \text{HCO}_3^- \\
 \underbrace{\text{H}^+ + \text{HCO}_3^-}_{\text{D}} \leftrightarrow \text{H}_2\text{CO}_3 \leftrightarrow \text{H}^+ + \text{HCO}_3^- \leftrightarrow \text{H}^+ + \text{HCO}_3^- \leftrightarrow \text{H}^+ + \text{HCO}_3^- \leftrightarrow \text{H}^+ + \text{HCO}_3^- \\
 \\
 \text{pH} = pK_1''' + \log_{10} \frac{[\text{HCO}_3^-]'}{\alpha_{CO_2} \times P_{CO_2}} \rightarrow [\text{HCO}_3^-]' = C_{CO_2} - \alpha_{CO_2} \times P_{CO_2} \\
 \alpha_{CO_2} = 0.1008 - 29.80 \times 10^{-3}[M] + (1.218 \times 10^{-3}[M] - 3.639 \times 10^{-3})t \\
 - (19.57 \times 10^{-6}[M] - 69.59 \times 10^{-6})t^2 \\
 + (71.71 \times 10^9[M] - 559.6 \times 10^{-9})t^3 \text{ (mmol l}^{-1} \cdot \text{mm Hg}^{-1}) \\
 pK_{1app}''' = \underbrace{6.583 - 13.41 \times 10^{-3}t + 228.2 \times 10^{-6}t^2 - 1.516 \times 10^{-6}t^3 - 0.341I^{0.323}}_{\text{A}} \\
 - \log_{10} \left\{ \underbrace{1 + 0.00039[\text{Pr}]}_{\text{B}} + \underbrace{10^{\text{pH} - 10.64 + 0.011t + 0.737I^{0.323}}}_{\text{C}} \right\} \\
 \times \left( \underbrace{1 + 10^{1.92 - 0.01t - 0.737I^{0.323} + \log_{10}[\text{Na}^+] + (-0.494I + 0.651)(1 + 0.0065[\text{Pr}])}_{\text{D}} \right) \rightarrow [\text{HCO}_3^-]'
 \end{array}$$

**Figure 9.2** Calculation of constants used to determine the physicochemical variables in body fluid compartments of animals (after Heisler, 1984, 1986).  $pK'''$  is the apparent dissociation constant of the  $CO_2$ /apparent bicarbonate  $[\text{HCO}_3^-]'$  system.  $\alpha_{CO_2}$  is the physical solubility of  $CO_2$ .  $C_{CO_2}$  is the total  $CO_2$  content of body fluids. Note that these equations comprise adjustments to variable ion and protein concentrations and ionic strength, and are applicable to seawater (cf. Pörtner *et al.*, 1998). Terms A-D refer to the respective reaction equilibria considered in the calculation of  $pK'''$ .  $M$  is the molarity of dissolved species (volume of protein and salt subtracted)  $t$  is the temperature ( $^\circ\text{C}$ , range 0 -  $40^\circ\text{C}$ ) and  $I$  is the ionic strength of non-protein ions;  $I = 0.5 \sum ([x]Z^2)$ , where  $[x]$  is the concentration in mol l<sup>-1</sup> and  $Z$  is the number of charges of the respective ion.  $[\text{Na}^+]$  is the sodium concentration (mol l<sup>-1</sup>) and  $[\text{Pr}]$  is the protein concentration (g l<sup>-1</sup>).

A variety of techniques have been used to measure pH in body fluids and tissues. They include glass electrodes, combination glass electrodes, ion-sensitive microelectrodes, glass microelectrodes, fluorescent dyes, pH-optodes, ISFET (Ion-Sensitive Field Effect Transistor) sensors and NMR (Nuclear Magnetic Resonance) spectroscopy. All methods have their pros and cons and often have overlapping areas of application. They are confronted with the need to analyse acid-base variables under undisturbed conditions, i.e. the result of the measurement should not be influenced by the measurement procedure itself. These issues are dealt with below.

The calibration of pH electrodes or optodes requires buffers that must be designed to match the ionic composition and strength of the respective compartment (see above). Ionic strength is similar in seawater and in the extracellular fluid of marine invertebrates, but is lower in the body fluids of fish, and in the intracellular compartments of all organisms. A shift in ion composition occurs from predominantly Na<sup>+</sup> in extracellular to predominantly K<sup>+</sup> in intracellular fluids.

### 9.3.1 Capillary pH electrodes, microelectrodes, pH optodes

Measurements of extracellular pH with capillary or micro-glass electrodes and pH optodes require sample volumes of 0.2 to 100 µl, or the implantation of the electrode or optode inside the body compartment. The optode can be used for online pH recordings by implanting it like a cannula. In this case no blood needs to be withdrawn.

Ideally, the pH of extracellular fluid (pH<sub>e</sub>) is measured using Radiometer glass capillary pH electrodes (G299A) or equivalent design with separate glass and reference electrodes for highest precision. Unfortunately, the capillary electrodes are no longer commercially available. Most pH microelectrodes are combination electrodes, which combine both an H<sup>+</sup> ion sensitive glass electrode, and a reference electrode into one housing. The change in potential  $\Delta E$  (V) across the ion sensitive glass with a change in pH is usually given by a simplified Nernst equation (the factor 0.0591 is valid at 25°C):

$$\Delta E = 0.0591 \times \Delta \text{pH} \quad (9.3)$$

Accordingly, calibration is required prior to use. Since the relationship between the electrode potential and pH of the solution is linear over a wide range of pHs it is sufficient to calibrate the electrode using two buffer solutions of known pH. Miniaturisation of the electrode is limited by the combination of two electrodes in one body. The tip diameter of commercially available micro pH electrodes ranges from 1 to 3 mm with an immersion depth of 1 to 3 mm resulting in a sample volume of about 10 to 100 µl. However, both the accuracy and the precision of microelectrodes decrease with decreasing size and range between 0.01 to 0.02 pH units (Kratz, 1950).

Most of the new optical pH sensors (pH optodes, e.g. pH HPS-OIW, PreSens, Regensburg, Germany) are fluorescence-based and measure the pH dependent luminescence decay time. No reference electrode is needed which allows minimisation of the optode tip down to 20 µm, enabling pH measurement in the sub-microliter range. Optodes are useful in the physiologically relevant pH range of pH 6 to 9. The response time ranges between 15 and 30 s at temperatures above 15°C and the accuracy and precision are better than 0.02 to 0.05 pH units in body fluids and reach up to about 0.01 pH units in seawater. The pH response is not linear and calibration may thus require more than two buffers, unless buffers are chosen close to the actual pH values of the sample. The sensitivity to ionic strength (salinity) is higher than in glass electrodes and fluorescent molecules in the sample may also interfere with the measurement (Wolfbeis, 1991; Kosch *et al.*, 1998; Liebsch *et al.*, 2001). Nonetheless, promising results have been obtained for measurements of intracellular pH (T. Hirse & H.-O. Pörtner, unpubl.), as well as for pH determinations in cephalopod blood and egg perivitelline fluid (Melzner, 2005; Gutowska & Melzner, 2009; Gutowska *et al.*, 2009).

The electrode or optode can be implanted into the wall of a syringe so that it is immersed into the sample when the syringe is filled. However, the sample volume required may become substantial (200 µl). Recently, a syringe setup with a combined oxygen and pH optode has been used for repeated sampling of haemolymph from a cephalopod during hypercapnic exposure (Gutowska *et al.*, 2009). Owing to the high sensitivity of the system to variable ionic strength, calibration was performed using plasma from the experimental animals



following termination of the experiment. The plasma was equilibrated under different CO<sub>2</sub>-air mixtures using a tonometer in order to reach different pH values.

During alternative measurement scenarios the blood sample is transferred to a small Eppendorf cap in which pH is measured. However, this procedure comes with the inherent risk of gas exchange between the sample and the air, and an associated drift in pH readings. Insertion into a glass capillary with an outer diameter only slightly larger than the electrode tip alleviates this problem and minimises air contact. The small tip diameter of a pH optode also allows insertion (under optical control with a binocular) through the needle into a syringe or into a glass capillary filled with body fluid (Thatje *et al.*, 2003; Welker *et al.*, 2007).

### ***Strengths and weaknesses***

The newest generation of pH glass electrodes is the result of almost 100 years of development and experience (Haber & Klemensiewicz, 1909). Special electrodes are available for a great variety of applications (e.g. high protein content or low salinity), but the availability of some types (e.g. capillary pH electrodes) is limited, as instrumentation developed for manual blood gas analyses in human blood samples has gone out of production. pH microelectrodes should be used whenever the sample volume is sufficient. In small samples and in high magnetic fields (e.g. NMR) pH-sensitive optodes are a suitable alternative. In addition, optodes are implantable (as established for oxygen optodes, cf. Frederich & Pörtner, 2000; Sartoris *et al.*, 2003; Lannig *et al.*, 2004; Melzner *et al.*, 2006a; Metzger *et al.*, 2007) allowing to measure blood/haemolymph Po<sub>2</sub> or pH online in fish and invertebrates. pH optodes need to be cross-calibrated with pH glass electrodes in the same media to detect any discrepancies depending on ionic strength.

Calibration procedures should use precision NBS buffers, or buffers allowing to determine free pH at adequate ionic strength and to cover the range of expected pH values. A two-point calibration is sufficient for electrodes. Ideally, buffers should have the same ionic strength as the sample, especially when using optodes. However, commercially available buffers usually do not fulfil this criterion. Seawater buffers can be made according to the recipes given by Dickson *et al.* (2007). Electrodes, which have a low cross sensitivity to ionic strength (salinity), should be equilibrated in a solution with the same ionic strength and composition as the sample prior to calibration and measurements. This procedure enhances accuracy and minimises memory effects and drift. For optodes, which have a high sensitivity to ionic strength and a non-linear pH response, calibration buffers must be adjusted to the appropriate ionic strength or be custom-made. The error needs to be quantified by cross calibration with glass electrodes. Coloured buffer solutions might cause problems when used with optodes as these use optical signals for pH measurement.

### ***Potential pitfalls***

Pitfalls are associated with imprecise calibration and differences in the ionic composition of buffers and body fluids. Furthermore, air contact of samples must be minimised as loss of CO<sub>2</sub> from body fluids and associated pH shifts will occur. Both the calibration and sensor readings are temperature-dependent. Precise temperature control is therefore critical to perform accurate measurements of pH. Calibration of the electrode and analyses of samples should therefore be carried out at the incubation temperature of the organism. pH measurements in the body fluids of small animals (small sample volumes) are associated with the problem that a decrease in tip diameter of the sensor results in a decrease in sensitivity. With optodes, small fluorescent molecules, for example the degradation products of haemoglobin, interfere with the fluorescence-based measurement and could lead to a drift of the optode response preventing precise pH determination. This problem is not easy to solve and may require improved optode design.

## **9.3.2 *In vivo* magnetic resonance imaging (MRI) and spectroscopy (MRS)**

*In vivo* <sup>31</sup>P-NMR spectroscopy is most suitable for non-invasive determinations of intracellular pH (Moon & Richards, 1973; Kinsey & Moreland, 1999). Such measurements have been carried out in tissues and whole organisms, ranging from plants, invertebrates and insects to fish and mammals, including marine invertebrates and

fish (Bock *et al.*, 2002, 2008; Bailey *et al.*, 2003; Melzner *et al.*, 2006). The position of the inorganic phosphate signal (P<sub>i</sub>) within the <sup>31</sup>P-NMR spectrum (Figure 9.3) is most commonly determined and used for intracellular pH calculations. The chemical shift of any nuclear magnetic resonance of compounds in fast-exchange protonation/deprotonation equilibria depicts the effect of pH according to a modified Henderson-Hasselbalch equation:

$$\text{pH} = \text{p}K_a' + \log_{10} \left[ \frac{\delta_{\text{pi}} - \delta_{\text{ac}}}{\delta_{\text{ba}} - \delta_{\text{pi}}} \right]. \quad (9.4)$$

$\text{p}K_a'$  is the apparent dissociation constant of inorganic phosphate and  $\delta_{\text{ac}}$  and  $\delta_{\text{ba}}$  are the chemical shifts of protonated and deprotonated inorganic phosphate, respectively. Usually these parameters are determined empirically when measuring the chemical shift of the inorganic phosphate signal ( $\delta_{\text{pi}}$ ) relative to a pH-independent reference (such as the phosphate resonance in the phosphagen, e.g. phospho-L-arginine). Calibration is performed using model solutions of known pH simulating the cytoplasm of the species to be investigated.

### Strengths and weaknesses

The use of inorganic phosphate as an endogenous pH indicator may be one of the most elegant ways to monitor changes in intracellular pH non-invasively, but there are a couple of drawbacks. The chemical shift of inorganic phosphate is influenced by factors other than pH, for example by temperature (Kost, 1990), protein concentration and free ion content (Roberts *et al.*, 1981). Calibration must be carried out for each species and experimental condition to avoid measurement errors. The model solution needs to reflect the cytoplasm of the species of interest. A careful analysis of the intracellular ionic strength and divalent cation concentrations can lead to an absolute accuracy of pH determination within  $\pm 0.05$  pH units (Roberts *et al.*, 1981; Madden *et al.*, 1991). Relative changes can be determined with accuracy better than  $\pm 0.02$  pH units. <sup>31</sup>P-NMR spectroscopy is a rather insensitive technique requiring good signal to noise ratios of *in vivo* spectra for a precise determination of the chemical shift of the free inorganic phosphate signal. A minimum tissue fresh mass is required for good

**Figure 9.3** *In vivo* <sup>31</sup>P-NMR spectra recorded in isolated body wall muscle tissue from *Sipunculus nudus* at extracellular pH 7.9, under control conditions (A), 20 min after the addition of 2% CO<sub>2</sub> (P<sub>CO<sub>2</sub></sub> = 1.97 kPa or 20,000  $\mu$ atm) (B) and when the intracellular acidification was reversed after 10 h (C). P<sub>i</sub>, inorganic phosphate; PLA, phospho-L-arginine; ATP, adenosine triphosphate. The inset shows the chemical shift of inorganic phosphate for A, B and C and the position shift with respect to PLA induced by changes in intracellular pH.

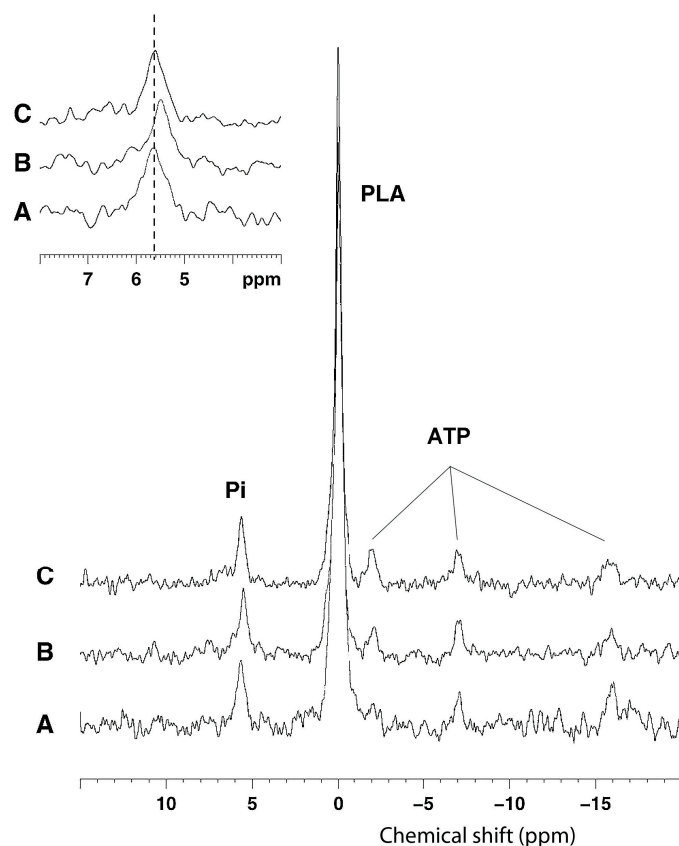

signal to noise ratios. However, the phosphate signal is not always detectable, for example in resting tissues of agile marine animals like cephalopods and fish (Bock *et al.*, 2002; Melzner *et al.*, 2006b), studied under conditions supporting standard metabolic rate (Sartoris *et al.*, 2003).

### **Potential pitfalls**

Unfortunately, inorganic phosphate is not applicable as an extracellular indicator of pH, because of its critically low concentrations and the usually larger differences between  $\text{pH}_e$  and  $\text{pK}_a$  in the extracellular space.

### **Suggestions for improvements**

The use of extracellular pH markers in both NMR spectroscopy and MR imaging has been described (for a review see Gillies *et al.* (2004)), but these substances have not yet been used in ocean acidification research. For instance, 3-Aminopropylphosphonate (3-APP) is a nontoxic, membrane-impermeable  $^{31}\text{P}$ -NMR marker, with a pH sensitive chemical shift of 1 ppm per pH unit. This indicator was successfully used for the determination of  $\text{pH}_e$  values in tumours of mice (Gillies *et al.*, 1994).  $\text{pH}_e$  and  $\text{pH}_i$  were monitored in parallel from *in vivo*  $^{31}\text{P}$ -NMR spectra, over a time course of about an hour. However, the limited sensitivity of  $^{31}\text{P}$ -NMR enables measurements of  $\text{pH}_e$  only in large tissue volumes. An improvement in spatial resolution was achieved when imidazoles were introduced as extrinsic  $\text{pH}_e$  indicators. Van Sluis *et al.* (1999) compiled  $\text{pH}_e$  recordings in breast cancer tumours with a spatial resolution of  $1 \times 1 \times 1 \text{ mm}^3$  using 2-imidazol-1-yl-3-ethoxycarbonyl-propionate (IEPA) and  $^1\text{H}$  magnetic resonance spectroscopic imaging ( $^1\text{H}$ -MRSI). Recently, localisation and temporal resolution could be improved further using either relaxation enhanced pH measurements involving gadolinium-based contrast agents as extracellular pH markers (Garcia-Martin *et al.*, 2006) or magnetisation transfer techniques (Zhou *et al.*, 2003). All these approaches have their specific benefits and drawbacks. Which technique is most suitable primarily depend on the type of application. For each of these substances to be used in a specific organism, tissue or cell preparation it must be demonstrated that the substance remains in the extracellular space and does not exhibit significant biological activity.

### **9.3.3 Common fluorescent indicators of intracellular pH**

Fluorescent pH indicators for monitoring cytosolic pH have been applied extensively in a wide range of cell types, primarily in cultured mammalian cells. A large literature base exists covering most aspects of their use. The most comprehensive description of the commonly used fluorescent pH indicators is provided by Haugland *et al.* (2005, Molecular Probes, The Handbook, at [www.probes.com](http://www.probes.com)).

The majority of fluorescent pH indicators are derivatives of fluorescein which displays pH-dependent fluorescence shifts. The use of fluorescein to monitor intracellular pH has been described in detail by Kotyk & Slavik (1989). Fluorescein can easily be loaded into cells in the form of diacetate ester (FDA). Intracellular esterases hydrolyse the ester to release the ionic, pH-sensitive fluorescein. A major drawback of fluorescein is that it leaks easily from cells. The use of carboxyfluorescein reduces cell leakage although the  $\text{pK}_a$  of carboxyfluorescein is around 6.5, which is rather low for strong responses to cytosolic pH (around 7.3, species and tissue specific, falling in the warmth, increasing in the cold). Rink *et al.* (1982) introduced BCECF-AM, a membrane permeable, hydrolysable ester (2',7'-bis(carboxyethyl)-5,6-carboxyfluorescein; Figure 9.4), as an intracellularly trappable fluorescent pH indicator with an appropriate  $\text{pK}_a$  value and low leakage rates.

Convenience of handling and the opportunity of simultaneous investigations in many cells with a new dimension of spatial resolution led to rapid dissemination of this method. For the past 20 years, BCECF has been the main dye used for monitoring intracellular pH. It has a very high selectivity for  $\text{H}^+$  and a  $\text{pK}_a$  around 7, close to cytosolic pH values. Moreover, the BCECF anion has up to 5 negative charges at physiological pH, which reduces its leakage from cells. BCECF can be loaded into most cells by incubation with the acetoxymethyl ester (AM) form. Intracellular trapping of the dye occurs once cellular esterases remove the AM group. Alternatively, membrane-impermeable free acid forms of the dye can be introduced into cells by microinjection (e.g. Gibbon & Kropf, 1994), through a patch clamp pipette or by electroporation or biolistics, as used for calcium indicators (Bothwell *et al.*, 2006). Cell impermeant forms can also be used to monitor extracellular pH.

## Part 3: Measurements of CO<sub>2</sub>-sensitive processes

SNARF and carboxy SNARF are two additional fluorescent dyes that are widely used to monitor intracellular pH. Carboxy SNARF has a  $pK_a$  around 7.5 and is therefore suitable for monitoring pH changes between 7 and 8. Variants of SNARF have a lower  $pK_a$  (around 7.2) and may be more suited to monitor pH changes at the lower end of the physiological range.

With new dyes (see below) and techniques, intracellular dye loading has been optimised by chemical modification. Expression vectors are available for dye synthesis within a transfected cell (Kneen *et al.*, 1998; Palmer & Tsien, 2006). Specific targeting of dyes into cytosolic compartments (Farinas & Verkman, 1999) and confocal laser fluorescence microscopy has further enhanced spatial resolution.

For a number of years, pHluorins, i.e. pH-sensitive forms of green fluorescent protein (GFP), have been used to monitor pH in intracellular compartments. This approach has the advantage of being essentially non-invasive since cells can potentially be genetically manipulated to express their own pH indicator. In addition to their use in monitoring cytoplasmic pH, pHluorins have the potential to be targeted to a range of cellular compartments. For example, a number of studies have used pHluorins targeted to the lumen of secretory vesicles providing highly sensitive monitoring of single cell secretory vesicle activity (Sankaranarayanan *et al.*, 2000).

pHluorins have the potential to provide long-term ratiometric monitoring of intracellular pH (e.g. Michard *et al.*, 2008). Calibration of pHluorins for monitoring cytoplasmic pH suffers from the same accuracy problems as the more conventional fluorescent indicators. So far, pHluorins have not been applied to any direct study of the effects of ocean acidification. Their application is currently limited by the availability of genetic transformation systems. A potential benefit of pHluorins that is particularly relevant to ocean acidification studies is that they should be suitable for monitoring intracellular pH during long-term experiments.

Prior to the experiment, viable cells or small tissue preparations (Bleich *et al.*, 1995) are incubated for about 20 min with BCECF-AM (1 to 10  $\mu$ M). BCECF becomes more concentrated with time and the majority of the dye is located in the cytoplasm. Illumination of BCECF by blue light (e.g. 488 nm) induces a green fluorescence (emission maximum 518 nm). The fluorescence intensity of the emitted (green) light is characteristically decreased by an increase in H<sup>+</sup> activity. If the dye is illuminated at 436 nm the emission intensity is lower and independent of pH (isosbestic point at 439 nm). This property enables ratiometric monitoring of intracellular pH independent of dye concentration. Figure 9.5 shows the intensities of the green fluorescence detected at 535 nm while pH is varied between 6.2 and 9.5. SNARF and carboxy SNARF dyes exhibit shifts in both their excitation and emission spectra, potentially making them more versatile for a range of optical systems.

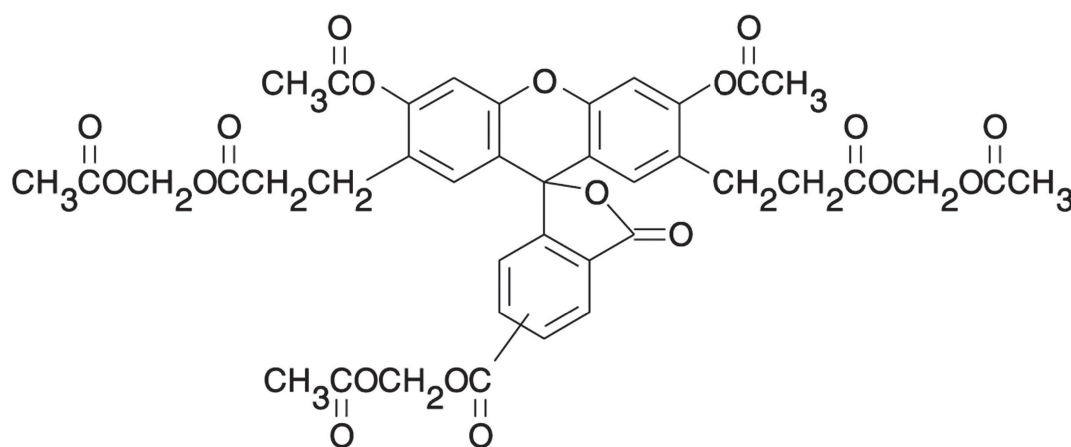

**Figure 9.4** Chemical structure of the BCECF-AM, an ester derivative of carboxyfluorescein which is membrane permeable and intracellularly hydrolysable. Modified from <http://probes.invitrogen.com>.

In particular, the emission spectrum shift makes these dyes more suited for confocal studies with single laser excitation (488 nm). The ratio of emission at 630 and 590 nm is pH-dependent. pH-sensitive fluorescent dyes may also be used in combination with other ion indicators (e.g. the calcium indicator fura-2) that have different excitation or emission properties.

The light from conventional sources (mercury or xenon lamp) is focused to a beam and the excitation wavelength is selected. After appropriate attenuation of the intensity by grey filtering, the beam is mirrored into the light path of the microscope in direction to the preparation. A dichroic mirror reflects the excitation light to the object and transmits the emission light on its way back to the detection system. For BCECF studies, a bandpass filter in the emission pathway selects the emission wavelength around 520 nm. Computer controlled selection of excitation wavelengths, either by a bandpass filter wheel or by a grid-based monochromator system, enables the alternating illumination of the cells at 436 and 488 nm. The data are collected by a photon counting tube or to a CCD camera as photon counts or pixel intensities. The phototube allows detection of very low signals at high time resolution while the CCD camera is slower and has a better spatial resolution. The highest spatial resolution is provided by confocal microscopy and a variety of laser lines (argon, helium-cadmium) are available to cover the excitation spectrum of BCECF.

During the experiment, the dye concentration falls due to photobleaching and cellular export. Hence, the fluorescence intensity follows this decline and cannot be used directly as a pH signal. Since the pH-dependent change of fluorescence intensity does not occur at 436 nm excitation, the ratio of emission intensities at 488 nm/436 nm excitation is calculated as a concentration-independent indicator of intracellular pH.

In order to translate the ratio values into  $H^+$  activity, a calibration procedure must be performed *in situ* (Thomas *et al.*, 1979). Nigericin, an ionophore for  $K^+$  and  $H^+$ , is used to permeabilise the cell membrane and pH is calibrated by extracellular solutions of defined pH. The composition of calibration solutions must mimic the cytosol in order to prevent the generation of a diffusion voltage which otherwise would bias the  $H^+$  activity inside the cell. Alternative calibration methods are discussed in Eisner *et al.* (1989).

An attractive approach to cellular acid-base physiology is the combination of patch clamp technique and fluorescence microscopy. Dye loading can be directly performed via the patch pipette which gives access to the cytosol. In this way, functional signals occurring in parallel to the changes in  $pH_i$  can be monitored. In addition, dextran-coupled BCECF is available with even better properties with respect to dye compartmentalisation. Its distribution is restricted to the cytosol and it displays very low leakage out of the cell.

An interesting aspect of pH measurements to investigate membrane transport and  $H^+$  homeostasis is the experimental modification of  $pH_i$ . In principle, every membrane-permeable weak acid or base can be used to transiently modify  $pH_i$  at constant extracellular pH. Buffers like  $NH_3/NH_4^+$ , propionic acid/propionate, acetic acid/acetate, and  $CO_2/HCO_3^-$  are frequently used. Figure 9.6 shows an example for  $CO_2/HCO_3^-$  and  $NH_3/NH_4^+$ .

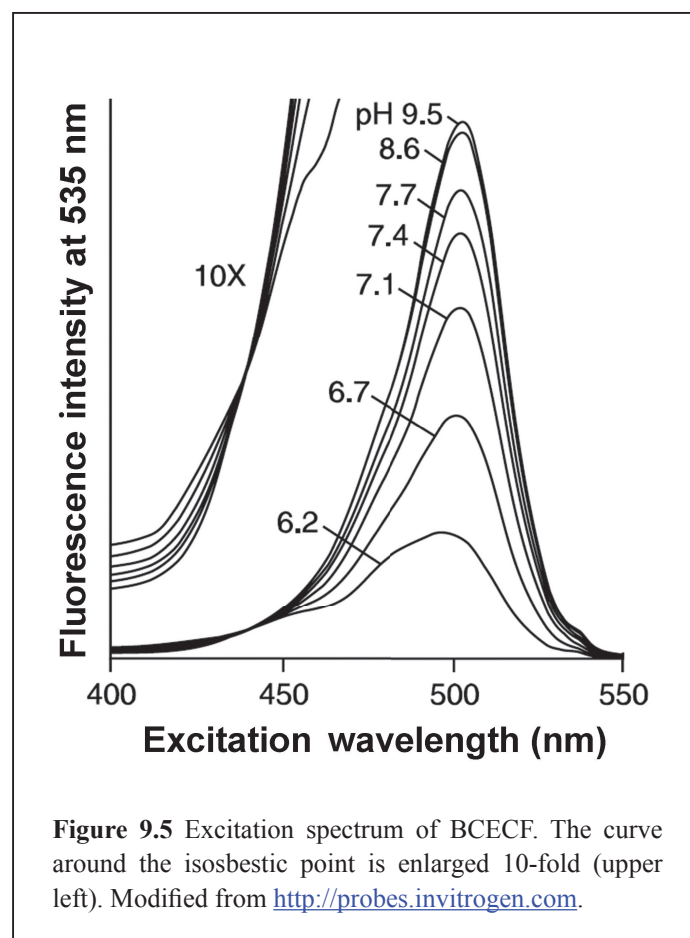

## Part 3: Measurements of CO<sub>2</sub> - sensitive processes

Normally, CO<sub>2</sub> is in equilibrium with HCO<sub>3</sub><sup>-</sup> and H<sup>+</sup>. For pH measurements this would mean that it is impossible to distinguish between the effects of CO<sub>2</sub> and HCO<sub>3</sub><sup>-</sup> on physiological processes. The challenging part in pH experiments involving CO<sub>2</sub>/HCO<sub>3</sub><sup>-</sup> buffers is therefore to alter the CO<sub>2</sub> concentration at constant levels of HCO<sub>3</sub><sup>-</sup> and pH. Although this seems to be contradictory to the Henderson-Hasselbalch equation, this approach is experimentally feasible. It makes use of the slow time constant for the generation of carbonic acid which is necessary to reach a new equilibrium after a change in one of the components. The method involves the acute mixing of two buffer solutions which immediately perfuse the cells under investigation (Zhao *et al.*, 1995; Figure 9.7).

### Strengths and weaknesses

pH<sub>i</sub> measurements by fluorescent dyes such as BCECF are robust and easy to perform. The approach is almost non-invasive and the signal obtained, even without spatial resolution, reflects cytosolic pH. The auto-fluorescence signal at the given excitation wavelengths of BCECF is low and does not limit the measurements even when dye loading is weak. There are calibration methods available which provide reasonable precision in interpreting the ratiometric data.

The overriding advantage of fluorescent indicators is that they are often the only method available for monitoring intracellular pH in individual small cells that are not tractable for microelectrode measurements. With respect to resolution, they also have clear advantages over bulk measurement methods when a small number of cells are available. Fluorescent indicators are less useful for monitoring pH in single cells within tissues due to optical problems associated with thick tissue. The use of AM ester loading can be considered to be minimally disruptive, given certain assumptions about the concentration of the dye. However, since pH dyes essentially act as pH buffers, loading too high intracellular concentrations may exert significant buffering around the pK<sub>a</sub> of the dye, possibly even enough to overcome the pH buffering mechanisms of the cells. In practice, this may be minimised by having a low concentration of dye in the loading solution (typically 1 to 10 μM) and by carefully controlling the loading time. Acetoxymethyl esters have low solubility in water and need to be prepared as stock solutions, normally 1 mM in dimethyl sulfoxide (DMSO). The incubation period, especially if performed in the presence of membrane permeabilising

**Figure 9.6** Effect of changes in pH<sub>i</sub> by the NH<sub>3</sub>/NH<sub>4</sub><sup>+</sup> and Na<sup>+</sup> dependence of cellular compensation of the respective acid load (modified from Bleich *et al.*, 1998). a) Perfusion of a 20 mM solution of NH<sub>3</sub>/NH<sub>4</sub><sup>+</sup> initially results in cellular alkalinisation (NH<sub>3</sub> enters the cell and buffers H<sup>+</sup>, NH<sub>4</sub><sup>+</sup> does not permeate the cell membrane). b) The cell recovers from the alkaline load with a certain time constant, for example by acid/base transport. c) Removal of NH<sub>3</sub>/NH<sub>4</sub><sup>+</sup> from the perfusion results in cellular acid load (NH<sub>3</sub> leaves the cell and H<sup>+</sup> is left behind). d) Cellular acid load is compensated by acid/base transport. The rate of recovery in this case depends on extracellular Na<sup>+</sup>. The rate is low at low concentration of Na<sup>+</sup> (5mM; d) and high at high Na<sup>+</sup> concentration (145mM; e).

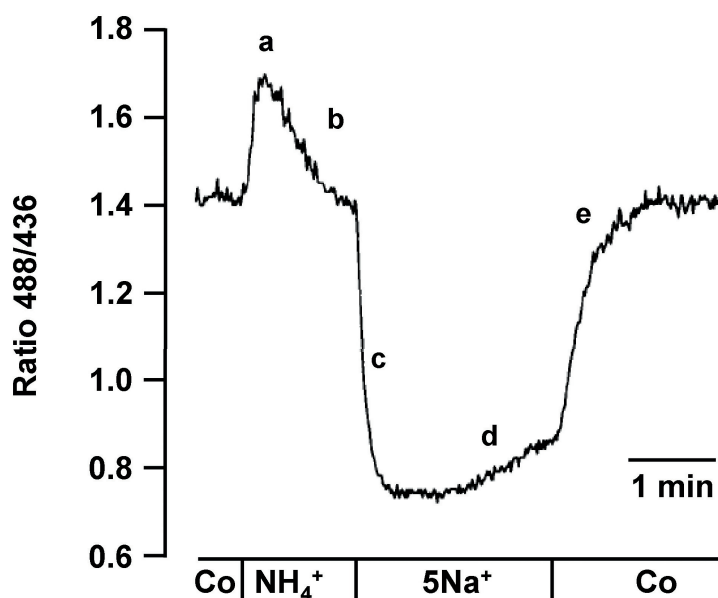

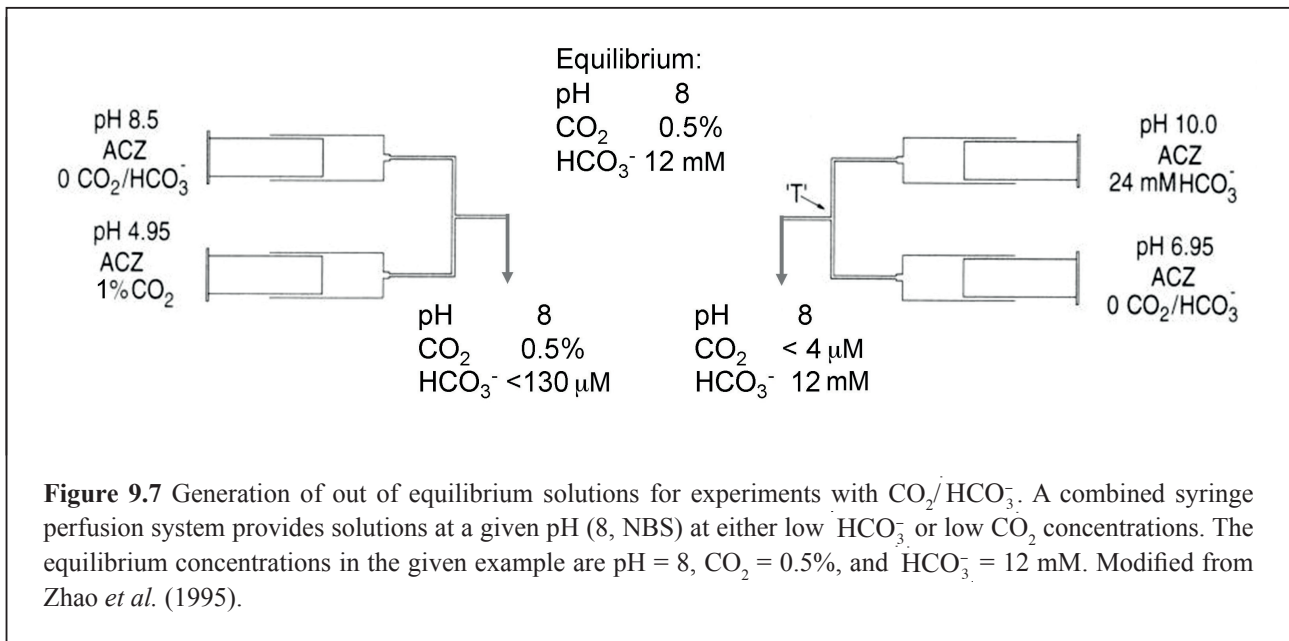

agents or detergents, takes place in non-physiological conditions which may cause irreversible changes to the investigated cells. Photobleaching of dye and cytosolic material limits the intensity of the excitation light or the duration of the excitation. At high intensities, light can cause significant heat damage to the cells. Although calibration is easy as long as there is a stable fluorescence ratio, i.e. as long as there is no significant background fluorescence or specific light absorption, the calculation of H<sup>+</sup> fluxes across the cell membrane requires the determination of the cytosolic buffer capacity, which is more difficult. Finally, the technique always implies a trade-off between time resolution and spatial resolution.

The BCECF and SNARF dyes share the advantage that they can be used in ratiometric mode. Both have been used extensively for imaging applications to individual cells in a variety of microscopy modes. Their use may also be combined with cell electrophysiology such as patch clamp (e.g. Trapp *et al.*, 1996). Measurements in individual cells are also possible using micro-photometry to record average intracellular pH values for single cells or small numbers of cells. Both the BCECF and SNARF dyes have been used with flow cytometry to gain information on the pH of cells maintained in culture (e.g. Musgrove *et al.*, 1986). They could potentially be used with natural populations of unicellular organisms, including phytoplankton.

The appropriate choice of a fluorescent dye depends on the cell type under study, the range of pH values to be monitored, the type of physiological response expected and, not the least, the recording apparatus available. In our experience, BCECF has certain advantages over SNARF for the measurement of intracellular pH in marine microalgae. Most cell types (including coccolithophores and diatoms) load particularly well with BCECF-AM, requiring loading periods of less than 30 min with 5 μM loading solution. The relatively wide separation of excitation wavelengths (450 and 480 nm) means that relatively broadband excitation (>10 nm bandpass) is possible. However, the dual excitation properties of BCECF limit its use to systems with dual wavelength excitation, either with a filter changer or monochromator for wide field studies or dual laser excitation for confocal or flow cytometry (e.g. using the 488 and 458 nm excitation of an argon ion laser). SNARF and carboxy SNARF offer the advantage of ratiometric emission indicators which can be used with a single wavelength excitation source (normally 488 nm). Optimal emission wavelengths are around 640 and 585 nm. A significant limitation of the use of SNARF and carboxy SNARF is that, while higher overall fluorescence signals are obtained with a 488 nm excitation, the relative emission peaks are considerably different at physiological pH around 7.2 with very low fluorescence at 590 nm. This can be overcome by exciting at 530 nm but with an overall reduced fluorescence yield. A further limitation with the use of SNARF is the proximity of the longer emission wavelength to the fluorescence emission

## Part 3: Measurements of CO<sub>2</sub>-sensitive processes

of chlorophyll. Therefore, light must be collected from a relatively narrow emission band with further reduction in signal. In small cells, such as the coccolithophore *Emiliana huxleyi*, the signal to noise ratio of SNARF may be limiting for useful measurements (Berry, 2001).

Dye bleaching is a significant limitation to the use of BCECF and SNARF dyes in individual cells and may limit measurements to a relatively short time period (typically a few minutes), depending on the type and intensity of the excitation. Dye bleaching is particularly problematic with smaller cells, where there is a limited pool of unbleached dye to replace the dye bleached in the region or focal plane of excitation.

A well-recognised problem with the majority of fluorescent ion indicators is dye compartmentalisation. Accurate measurement of cytoplasmic pH is the goal of many studies using fluorescent pH indicators. However, the dye can be compartmentalised into subcellular organelles and vacuoles, either by diffusion of the undissociated AM ester or by direct translocation of the free anion by membrane transporters. Compartmentalisation can be identified by the appearance of punctuate fluorescence and a drifting ratio signal as dye enters more acidic or alkaline compartments. The time course and extent of compartmentalisation may strongly depend on the cell type. In short-term experiments this may not be problematic. Compartmentalisation may be overcome by the use of dextran-conjugated indicators (both BCECF and SNARF are available as high molecular weight dextran conjugates). However, this requires loading of the dextran conjugate into the cell by disruptive procedures such as microinjection or biolistics. The combined effects of bleaching, compartmentalisation and dye extrusion generally lead to reduced dye signal during the course of an experiment and therefore fluorescent pH indicators are generally not suitable for long-term measurements.

The pH sensitivity of BCECF or SNARF may be better than 0.05 pH units in ideal solutions. However, the accuracy of pH measurement is far less certain due to uncertainties associated with intracellular calibration of the dye. Indeed, calibration is the major limitation of the use of fluorescent intracellular ion indicators. Accurate calibration of intracellular pH indicators presents a particular set of problems. The  $pK_a$  of fluorescent pH indicators is affected by the ionic strength of the solution. Extracellular calibration in pH-buffered solutions with ionic strength adjusted to mirror that of the cytosol may partially overcome this limitation. However, other cellular factors may significantly influence the behaviour of the dye. These include cytosolic viscosity (Poenie, 1990), the presence of other pigments (e.g. chlorophyll) that may preferentially absorb different excitation wavelengths of BCECF and the presence of autofluorescent pigments. For accurate monitoring of intracellular pH in dye-loaded cells, it is necessary to be able to clamp the pH of the intracellular compartment under study to a known value. The H<sup>+</sup> ionophore nigericin has been widely used to achieve control of cytosolic pH. Nigericin creates pores that allow the exchange of H<sup>+</sup> with K<sup>+</sup>. In an ideal experiment, this overrides the cell transport processes, allowing the equilibration of K<sup>+</sup> and H<sup>+</sup> fluxes across the membrane and will clamp cytosolic pH according to the intracellular and extracellular concentrations of K<sup>+</sup> according to the equation:

$$\frac{[K_{in}^+]}{[K_{out}^+]} = \frac{[H_{in}^+]}{[H_{out}^+]} \quad (9.5)$$

In practice,  $[K_{out}^+]$  is set to approximate  $[K_{in}^+]$  (100 to 200 mM) so that  $pH_{out} = pH_{in}$ . It follows that accurate clamp of intracellular pH requires a good knowledge of  $[K_{in}^+]$ . While this approach has been used in a large number of studies, including with marine phytoplankton (Dixon *et al.*, 1989), it is recommended to perform an additional calibration procedure such as by the use of weak acid and base treatments to achieve maximum and minimum fluorescence ratios corresponding to H<sup>+</sup>-saturated and H<sup>+</sup>-free forms of the dye (James-Kracke, 1992).

The use of fluorescent indicators in ocean acidification studies is clearly best suited to monitor changes in pH in short-term physiological experiments aimed to better understand pH regulatory mechanisms. In such studies, fluorescent indicators can give relatively high precision measurements with excellent spatial and temporal resolution. Their applicability to accurate assessment of resting pH or for monitoring long-term changes in intracellular pH is limited due to a range of factors that tend to result in dye loss and difficulties with accurate calibration.



### ***Potential pitfalls***

Potential cell damage by tissue preparation and incubation can occur and is not necessarily visible in the fluorescence results. Additional functional testing of cells under investigation is strongly recommended. Since BCECF-AM is lipophilic, the pigment is dispersed rather than dissolved and requires addition of DMSO as a detergent. A reasonable level of dispersion is only obtained if the stock solution is pipetted directly into a large volume of experimental solution rather than the other way around. Overloading of cells with dye leads to additional cytosolic buffering and the pH is clamped. On the other hand, only efficient dye loading enhances the signal to noise ratio. This is especially relevant for BCECF since the emission at 436 nm excitation is weak (Figure 9.4). There are a variety of cells which express transporters for organic anions which bind and remove the dye from the cell at high transport rates (e.g. renal proximal tubule cells).

In imaging experiments, one should carefully follow and understand the calculation procedures of the imaging software, which finally results in the fluorescence ratio value for a selected region of interest. Background noise and selected intensity thresholds might influence these values significantly. Measurements outside the experimental pH range, given by the  $pK_a$  of the dye, means leaving the range of linear relations between the fluorescence ratio and pH. No quantitative measurements can be performed outside this range. The most interesting information on cytosolic pH regulation is derived from time constants for the recovery of  $pH_i$  after experimental manipulation. The precision of such data strongly depends on the flow of the medium bath and on exchange rates in relation to the kinetics of the transport mechanisms under investigation. It is strongly recommended to monitor the successful equilibration of the  $CO_2$  solutions and to ascertain that the temperature is constant.

### ***Suggestions for improvements***

All factors influencing the preparation as well as the measurement itself should be optimised for a given tissue preparation. In some cases it is feasible to invest into the generation of cell cultures with defined properties, dependent on the availability of native material. Cell cultures also enable experimental approaches at larger scales and to target genes of interest.

#### **9.3.4 New fluorescent indicators of intracellular pH**

Ageladine A is a brominated pyrrol-imidazole alkaloid, which was first isolated and described by Fujita *et al.* (2003). The dye was found in extracts of the sponge *Agelas nakamura* by using bioassay-guided fractionation. The substance shows biological activity which involves the inhibition of matrix metalloproteinases and of cell migration of bovine endothelial cells. Meketa & Weinreb (2006) and Shengule & Karuso (2006) completed the synthesis of ageladine A, which was later optimised by Meketa & Weinreb (2007) and Meketa *et al.* (2007). Bickmeyer *et al.* (2008) described its fluorescence spectra and pH-dependency as well as its application as a dye in isolated cells and transparent animals.

Ageladine A is brominated and can be protonated on the guanidine moiety, which stabilises the molecule in two forms. Maximum fluorescence is at 415 nm under excitation with UV light (365 nm) with a broad emission spectrum up to more than 500 nm (Figure 9.8). Fluorescence changes of ageladine indicate pH values in the range between 4 and 9, with a half maximal pH of 6.26. UV excitation ranges from 325 to 415 nm with an excitation maximum at 370 nm. Dye concentration influences fluorescence; hence, the calculation of pH requires calculation of the concentration using a calibration curve. A rough pH estimate can be obtained from the fluorescence intensity derived from the ratio at excitations of 340 and 380 nm. At higher dye concentrations, this two-wavelength approach reduces the concentration dependency of the measurements. In cells and membranes, ageladine A concentrations are usually unknown and may only be estimated from its concentration used during incubations. In a standardised procedure, cells or tissues are loaded with 10  $\mu$ M ageladine A for 10 min, whereas 30 min are required in whole animal procedures. Small pH changes are best monitored by excitation at 370 nm and emission at  $>415$  nm or using the Fura 2 filter settings (340/380 exc.). The calculation of exact pH values can only be obtained if the dye concentration is known, which is hardly feasible in living cells and tissues.

### Strengths and weaknesses

Ageladine A, because of its bromination, easily passes membranes and can therefore be used to stain single cells as well as whole animals or organs. It is best to use in transparent aquatic animals. The use of a UV fluorescent microscope with whole animals allows to easily spot specific tissues. We presently think that only acidic tissues and cells become fluorescent, because ageladine A shows weak or no fluorescence at pH 8 to 9. pH changes can be monitored with high sensitivity, but for exact pH values, the actual dye concentration has to be known. This is the most critical point, because it is very difficult or nearly impossible to know the exact concentration of the dye at the site of the measurement in living tissue. Current research investigates whether the dye accumulates in cell membranes and whether it is stabilised when protonated. A major advantage of ageladine A is its emission at 415 to 430 nm where autofluorescence is very low. This considerably increases the signal to noise ratio compared to other pH-sensitive dyes with emissions at longer wavelengths.

### Potential pitfalls

At the moment it is not known whether ageladine A interacts with divalent ions or other molecules to produce false positive results. If it accumulates in cellular membranes, the pH sensitive guanidine moiety should be directed towards the cytosol and track pH changes. It remains to be explored whether some of the guanidine moieties are directed outwards and respond to extracellular pH. In that case, local pH changes close to the membrane may lead to erroneous estimates of bulk changes in pH.

### 9.3.5 Homogenate analyses of intracellular pH

The mean pH<sub>i</sub> of tissues can be determined by the homogenate method (Pörtner *et al.*, 1990). The homogenate technique allows for a clear allocation of mean intracellular pH values in tissues to the experimental condition of the animal. It eliminates time delays in pH<sub>i</sub> assessment associated with other techniques (delays caused by diffusion limitation, delayed equilibration between compartments or the necessity to accumulate recordings to improve the signal to noise ratio). The method follows the freeze-stop technique, which had been established for determining the metabolite status of shock frozen tissues (Wollenberger *et al.*, 1960). Since tissues can be stored away under liquid nitrogen until analysis the method is applicable to samples collected in the field.

Tissue samples are ground in liquid nitrogen using a mortar and pestle, and the tissue powder is then thawed in a medium containing potassium fluoride (KF) and nitrilotriacetic acid (NTA). The volume of medium is about 5 times the wet weight of the tissue; for example, about 100 mg of tissue powder are placed into 600 µl of ice-cold medium (160 mM KF, 1 mM nitrilotriacetic acid, pH 7.4). KF and NTA remove the Mg<sup>2+</sup> and Ca<sup>2+</sup> ions and prevent ATP-dependent metabolism, which occurs through the action of Mg<sup>2+</sup> and Ca<sup>2+</sup>-dependent ATPases and kinases. The concentration of NTA is minimised to avoid proton release during its binding of Mg<sup>2+</sup> and Ca<sup>2+</sup>. It is set just high enough to minimise the metabolic activity of the tissue. After completely

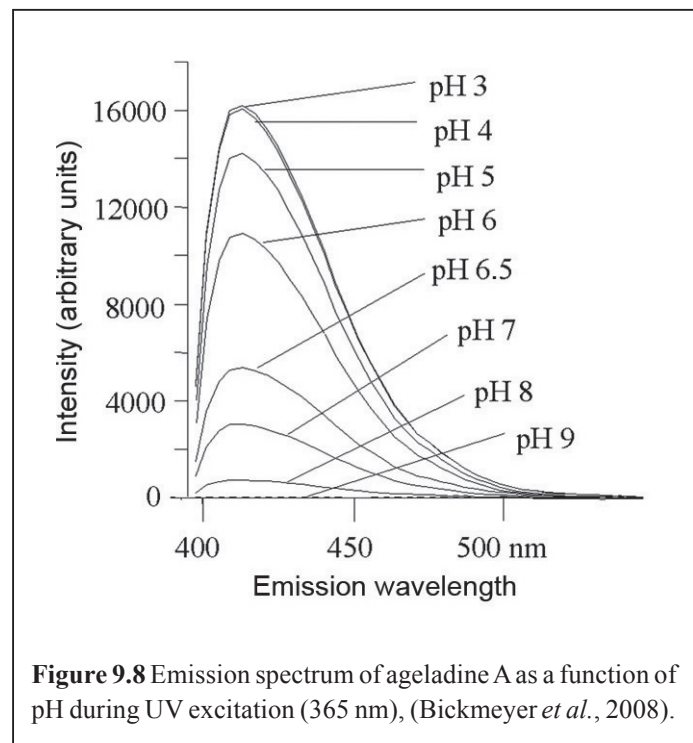

filling the vial with medium, the mixture is stirred with a needle in order to release air bubbles. It is then mixed vigorously and centrifuged for 30 s. In the original procedure the pH of the supernatant is measured using a Radiometer glass capillary pH electrode (G299A). pH microelectrodes and more recently, pH optodes, have also been used successfully (Krause & Wegener, 1996; T. Hirse & H.-O. Pörtner, unpublished). The resulting value approaches  $pH_i$  with an experimental error of less than 0.01 pH units (Pörtner *et al.*, 1990). According to model calculations (Pörtner *et al.*, 1990), any distortion in the measured pH values due to either the pH of the medium, dilution by the medium or mixing with intra- or extracellular fluids can be disregarded. The accuracy of the method for each individual pH measurement is confirmed by the strong correlation of  $pH_i$  changes with changes in metabolic parameters (Pörtner *et al.*, 1991a, 1996). See Pörtner (1987a, 1995) for details on how the metabolism shapes the pH response and influences non-bicarbonate buffering.

### ***Strengths and weaknesses***

The homogenate technique determines intracellular pH in tissues with much less signal to noise ratio than methods using dimethyl-oxazolidine-dione (DMO) (see below),  $^{31}\text{P}$ -MRS or fluorescent dyes. The homogenate technique shows a variability one order of magnitude lower and a level of precision and accuracy one order of magnitude higher than the DMO technique (Pörtner *et al.*, 1990), which is therefore rarely used nowadays.

The homogenate technique is the only method that includes the quantitative contribution of all cell and tissue compartments to mean cellular pH and in response to acid-base disturbances, with an emphasis on cytosolic pH (see below). For successful analysis, the resting and experimental states of the tissues must be maintained during invasive sampling. Experimental animals may have to be anaesthetised prior to tissue sampling and decapitated to eliminate a potential stress response (Pörtner *et al.*, 1990, 1991a,b; Tang & Boutlier, 1991). The main merits of the homogenate technique are the simple methodological procedure, low cost, low variability and the small sample size required (as low as 20 mg fresh weight). The method can be used with samples collected from active animals or even from animals collected in the field. The latter is especially relevant in the context of investigations of ocean acidification *in situ*. The main drawback of the method is that it only allows point measurements as the organism is sacrificed.

### ***Potential pitfalls***

$\text{CO}_2$  condensation into the liquid nitrogen and onto pre-cooled instruments may cause acidification of the samples and must be minimised during the preparation of the homogenate. The use of clean liquid nitrogen and dewars, mortars and pestle free of rime is required. A short but efficient grinding procedure under a nitrogen atmosphere excludes contamination with condensating  $\text{CO}_2$ . It is usually sufficient to grind on the bottom of a box, for example a Styrofoam box, allowing the evaporating nitrogen to fill up the volume above the mortar and pestle. pH is best measured in a thermostatted capillary pH electrode, after preparation and centrifugation of the homogenate in a closed Eppendorf cap (usually 0.5 ml, volume to be reduced with small sample size). If required, complete tissue extraction can be ensured using ultrasound. The pH electrode and supernatant (e.g. inside the capillary electrode) must be thermostatted at the experimental temperature of the animal in order to avoid artefacts. Nitrioltriacetic acid (NTA) rapidly binds calcium and magnesium ions and thereby stops metabolism. At the same time, its concentration needs to be minimised since it releases protons during the binding process. An excess of fluoride in the reagent solution minimises proton release from NTA due to the formation and precipitation of magnesium or calcium fluorides.

### **9.3.6 Analyses of non-bicarbonate buffer values**

The *in vivo* response of buffers to disturbances of the acid-base equilibrium comprises closed (no exchange with other compartments) and open system (substances such as  $\text{CO}_2$  can be exchanged) characteristics. The  $\text{CO}_2$ /bicarbonate buffer reaches high values in an open system (when  $P_{\text{CO}_2}$  is maintained and  $\text{CO}_2$  generated by the acid titration of bicarbonate is released). Such  $\text{CO}_2$ /bicarbonate buffering in open systems is relevant especially in animals with high internal  $P_{\text{CO}_2}$  levels. Accordingly, the bicarbonate buffer needs to be distinguished from non-bicarbonate buffers (mostly protein and inorganic phosphate).

## Part 3: Measurements of CO<sub>2</sub> - sensitive processes

Determinations of tissue non-bicarbonate buffer values by tonometry (Heisler, 1989; Pörtner, 1990a) use CO<sub>2</sub> for the titration of buffers and thereby mimic the respiratory changes in the acid-base status *in vivo*. Changes in the bicarbonate levels associated with CO<sub>2</sub>-driven changes in pH reflect the involvement of non-bicarbonate buffers (Heisler & Piiper, 1971; cf. Figure 9.1).

The non-bicarbonate buffer value ( $\beta_{NB} = -\Delta[\text{HCO}_3^-]_e / \Delta\text{pH}_e$ ) of the extracellular fluid (whole blood, haemolymph and coelomic fluid) is typically determined by CO<sub>2</sub> equilibration using an intermittently rotating cuvette (tonometer model 273, Instrumentation Laboratory, Paderno Dugano, Italy) flushed with a humidified mixture of CO<sub>2</sub> in air (between 0.2 to 1%) provided by a gas mixing pump (Wösthoff, Bochum, Germany). The samples of haemolymph are tonometered for 25 min to allow equilibration and are then analysed for pH and total CO<sub>2</sub> content C<sub>CO<sub>2</sub></sub> as described below.

Tissue non-bicarbonate buffer values are best determined using the homogenate technique under metabolic inhibition. This method yields values under control conditions as required for quantitative treatments, i.e. the pH/bicarbonate analysis of proton quantities underlying observed changes in acid-base parameters (e.g. Pörtner, 1990a; Pörtner *et al.*, 1991a, b; Ferguson *et al.*, 1993). Initially, intracellular buffer values  $\beta_{i(NB, NP)}$  (non-bicarbonate, non-phosphate buffer values) of tissues are determined (Pörtner, 1990a). In brief, tissues are powdered under liquid nitrogen, samples of tissue powder are then placed into preweighed tonometer vessels containing an ice-cold solution composed of 540 mM KF and 10 mM nitrilotriacetic acid (1:3 w:v). Homogenates are tonometered under humidified gas mixtures between 0.5 to 4% CO<sub>2</sub> in air in the order medium to low (high) to medium to high (low) CO<sub>2</sub> (Heisler & Piiper, 1971). After equilibration for 25 min, samples taken at each CO<sub>2</sub> level are rapidly centrifuged in a capped Eppendorf tube and the supernatants analysed for pH and C<sub>CO<sub>2</sub></sub> as described below and for free inorganic phosphate as described by Pörtner (1990a). The intracellular buffer values of tissues are calculated by applying a correction for the dilution of the respective tissue and for extracellular space according to the following equation (Heisler & Neumann, 1980):

$$\beta_{i(NB, NP)} = (\beta_{(NB, NP)} \times V) + \frac{(F \times W)}{F \times W \times (1 - Q)}; \quad (9.6)$$

where  $\beta_{i(NB, NP)}$  is in mmol pH<sup>-1</sup> kg<sup>-1</sup> wet weight,  $V$  is the volume of the medium,  $F$  is the fraction of tissue water,  $W$  is the blotted fresh weight and  $Q$  is the fractional extracellular volume. The buffer values of inorganic phosphate is added to this value according to free intracellular concentrations under resting conditions (about 1 mmol kg<sup>-1</sup> wet weight).

The water content of tissues is determined by drying at 110°C for 24 h. The extracellular space of tissues is determined after incubation in artificial seawater (invertebrates) or in a Ringer solution (fishes) in the presence of 0.1 µCi (0.037 MBq) per ml of <sup>3</sup>H-inulin for 1 h. The tissues and perfusate are then deproteinised with 0.6 N perchloric acid and the <sup>3</sup>H activity of the supernatant is measured with a liquid scintillation counter. The fractional extracellular volume ( $Q$ ) of the tissue is calculated as the ratio of extracellular tissue water volume and total tissue water volume according to Heisler (1975).

### **Strengths and weaknesses**

Invasive (homogenate technique) and non-invasive approaches (by <sup>31</sup>P-NMR) for the determination of tissue buffer values yield similar values of  $\beta_{NB}$  (Wiseman & Ellington, 1989; Pörtner, 1989, 1990a). The homogenate technique requires high concentrations of KF for sufficient inhibition, which implies the need of correcting for changes in ionic strength of the medium as well as for the buffering effect of the accumulated inorganic phosphate.

### **Potential pitfalls**

Regardless of whether buffer values are determined in intact tissue or homogenates, metabolic processes may respond to experimental changes in pH and may interfere with the measurements leading to erroneous pH values or the production of additional buffers during the titration (cf. Pörtner, 1989). Hence, the buffer value measured does not actually correspond to any definite physiological state of the tissue, and definitely not to

that of control conditions. Most published non-bicarbonate buffers are, therefore, erroneously high because cytosolic buffering is increased during the titration procedure in similar ways as during anaerobic exercise, due to the release of inorganic phosphate from phosphagen and ATP. Complete metabolic inhibition and continuous recording of pH during the titration procedure enable accurate analyses but correction for such metabolic shift is nonetheless required.

### 9.3.7 Analyses of total CO<sub>2</sub> in body fluids and homogenates

Partial pressure of CO<sub>2</sub> in body fluids is measured by CO<sub>2</sub> electrodes. The total CO<sub>2</sub> content (C<sub>CO<sub>2</sub></sub>) of body fluids (equivalent to the total dissolved inorganic carbon (DIC) in chemical oceanography, plus CO<sub>2</sub> bound to some proteins such as haemoglobin) can be determined after release of gaseous CO<sub>2</sub> by addition of acid. Detection of the CO<sub>2</sub> released occurs by various methods, ranging from electrodes to infrared analyses, conductometric methods and gas chromatography (Cameron, 1986). Gas chromatography (Lenfant & Aucutt, 1966) has been adapted to work with small sample volumes (20 to 50 µl) and a high precision to about 0.05 mM (Boutilier *et al.*, 1985; Pörtner *et al.*, 1990). Alternatively, Corning 965 CO<sub>2</sub> analysers can be used to measure DIC or C<sub>CO<sub>2</sub></sub> with an accuracy of about 0.1 mM on 50 to 250 µl fluid samples. Some authors have even reached an accuracy of 0.02 mM when analysing large sample volumes (250 µl) of mussel haemolymph and bracketing each sample with known bicarbonate standard (Booth *et al.*, 1984). Refurbished Corning CO<sub>2</sub> analysers are still available on the market (Olympic Analytic Service OAS, Malvern, UK) and are relatively inexpensive. These instruments are based on the release of gaseous CO<sub>2</sub> by mixing of a fluid sample with a lactic acid solution in a sealed chamber and subsequent CO<sub>2</sub> determination using a thermal conductivity detector.

C<sub>CO<sub>2</sub></sub> of extracellular fluids should be measured after removal of cellular components by centrifugation. C<sub>CO<sub>2</sub></sub> levels of intracellular fluids are analysed after tissue extraction, which leads to contamination by extracellular compartments, including interstitial fluids (cf. Pörtner *et al.*, 1990). For further evaluation of the CO<sub>2</sub>-bicarbonate system, the physical solubility of CO<sub>2</sub>, ( $\alpha$ ), and the apparent dissociation constant  $pK^{\prime\prime}$  of carbonic acid for body fluids and seawater are calculated according to Heisler (1986). The calculation is very flexible as the constant can be adjusted to a wide range of ionic compositions, ionic strengths and protein levels in the various compartments. The concentration of the apparent bicarbonate concentration in extracellular plasma ( $[HCO_3^-]_e$ ) is calculated from C<sub>CO<sub>2</sub></sub> according to the equation:

$$[HCO_3^-]_e = C_{CO_2} - (\alpha_{CO_2} \times P_{CO_2}) \quad (9.7)$$

Note that the apparent bicarbonate concentration includes both the bicarbonate and carbonate species. See Pörtner *et al.* (1990) for a full set of equations.

#### **Intracellular P<sub>CO<sub>2</sub></sub> and bicarbonate levels**

The analysis of pH<sub>i</sub> and total CO<sub>2</sub> levels (C<sub>CO<sub>2</sub></sub>) in the homogenate allows quantifying the cellular bicarbonate concentration and P<sub>CO<sub>2</sub></sub>. The total CO<sub>2</sub> measured in the homogenate must be corrected for fractions of extracellular water and CO<sub>2</sub> content using an adequate marker for extracellular space (for example radiolabelled inulin) to derive intracellular C<sub>CO<sub>2</sub></sub> levels (Pörtner *et al.*, 1990):

$$P_{iCO_2} = \frac{C_{CO_2}}{10^{pH_i - pK^{\prime\prime}} \times \alpha + \alpha} \quad (9.8)$$

The calculation of intracellular C<sub>CO<sub>2</sub></sub> requires parameters analogous to those needed for the determination of intracellular pH from DMO (dimethyl-oxazolidine dione) distribution. Consequently, errors similar to those involved in the DMO approach arise (see below). The intracellular P<sub>CO<sub>2</sub></sub> calculated from the intracellular total CO<sub>2</sub> concentration (Pörtner *et al.*, 1990, 1991a, b, 1996; Boutilier *et al.*, 1993; Reipschläger & Pörtner, 1996) exhibits a relatively large variability, which can be reduced by highly accurate estimates of intracellular pH as with the homogenate technique.

With adequate knowledge of the relationships between the intra- and extracellular pH, P<sub>CO<sub>2</sub></sub> and bicarbonate levels, intracellular acid-base parameters in isolated muscle tissues could be varied and clamped by setting

adequate values in the extracellular medium (Reipschläger & Pörtner, 1996). Among all acid-base parameters only a decrease in extracellular pH was suitable to cause metabolic depression during environmental stress (Pörtner *et al.*, 2000). Further experimental, mechanistic, studies are needed to demonstrate the regulatory function of individual acid-base parameters. This will support the development of a cause and effect understanding beyond what can be provided by empirical or correlative analyses.

### 9.4 Compartmental measurements: towards a quantitative picture

#### 9.4.1 Extracellular fluids

##### *Coleomic fluid, haemolymph and blood*

Seawater is the extracellular space for unicellular organisms and the original extracellular fluid of marine animals. Accordingly, the body fluids of most marine invertebrates display ion compositions similar to those of seawater. In echinoderms, the extracellular fluid is (still) in contact with seawater, indicating that changing the ion composition or the acid-base status of these fluids through ion exchange processes only occurs within narrow limits.

The study of extracellular acid-base status requires to consider that acute sampling of body fluids from an animal (“grab and stab”) involves disturbance and stress responses, including shifts in the acid-base status, due to changes in metabolic rate, muscular contraction, release of stress hormones etc. It is recommended to implant a permanent optode or a catheter, which is used to withdraw blood after adequate recovery. This is especially important in the more alert fishes, cephalopods and decapod crustaceans. If the “grab and stab” approach cannot be avoided, some species should be anaesthetised prior to sampling, using an excessive dose of anaesthetic. The sampling procedure itself, for example through puncturing, needs to be as short and as gentle as possible (for fishes, see for example Welker *et al.*, 2007). The results of such procedures must be interpreted with caution and, if possible, cross-calibrated with analyses in cannulated specimens. Interpretation should be restricted to relative changes. In general, sampling for blood gas analyses should exclude contamination with air bubbles by use of a gas tight syringe and of cannulas filled with Ringer solution. For small animals, for example small invertebrates or larvae, one can use a glass capillary pulled to a small tip (by use of an electrode puller or by hand above a flame). After puncturing the animal body surface, blood or haemolymph is sucked into the glass by capillary forces.

In bivalves, samples of haemolymph have been collected by pericardiac puncture (Fyhn & Costlow, 1975) or from the posterior adductor muscle sinus (e.g. Booth *et al.*, 1984). Samples have been withdrawn from the coelomic cavity of sipunculids after cannulation (Pörtner *et al.*, 1998) or from echinoderms by a “grab and stab” approach (e.g. Spicer *et al.*, 1988). After, or in parallel to rapid analysis for extracellular acid-base parameters, tissues are excised, blotted dry, freeze-clamped and kept under liquid nitrogen until used for the determination of pH<sub>i</sub> and buffering capacity (e.g. Michaelidis *et al.*, 2005). For acute blood and tissue sampling in fishes, a concentrated solution of buffered anaesthetic (Tricaine methanesulfonate, MS-222, buffered by the addition of sodium bicarbonate) is slowly added to the aquarium to achieve a species-specific final concentration of, for example, 0.15 g l<sup>-1</sup>. Within 2 to 3 min, the fish loses balance and can be removed from the water without struggling. The second best approach after cannulation is to withdraw blood from the caudal vein into a heparinised syringe for analysis of extracellular pH (pH<sub>e</sub>), P<sub>CO<sub>2</sub></sub>, [Hb], haematocrit, lactate levels etc. The fish is then killed and tissues (e.g. heart and skeletal muscle) are excised and frozen immediately in liquid nitrogen for later analysis of intracellular pH. Sampling can be completed within 2 to 3 min after the fish has been removed from the water.

Blood and haemolymph collected in gas tight syringes may clot on the surfaces of syringes, electrodes and optode tips. Heparinisation of these surfaces often solves this problem. Since heparin influences the bicarbonate level and arterial CO<sub>2</sub> tensions (P<sub>a</sub>CO<sub>2</sub>) one should make sure that no liquid heparin is left after flushing (Madiedo *et al.*, 1982). Extracellular acid-base parameters are determined in blood plasma or equivalent. For C<sub>CO<sub>2</sub></sub> analysis and associated acid treatment this requires the removal of cellular components by centrifugation. This is not usually required for blood gas or pH analyses.

### ***Interstitial pH***

Most attention has focused on the properties of intracellular and extracellular bulk fluids when acid-base regulation of an animal is discussed. However, interstitial fluid is the one in contact with the cell membrane and mediates all extracellular signal transfer to the cell. There is no direct method available to investigate the acid-base parameters in the interstitial fluid or on the cellular surface *in vivo*. However, it is important to note that a  $P_{CO_2}$  gradient may prevail between the intra- and extracellular fluids which is likely to cause a lower interstitial pH than plasma pH, owing to minimal non-bicarbonate buffering in the interstitial fluid (Pörtner *et al.*, 1991b; Pörtner, 1993). The presence of a  $P_{CO_2}$  gradient would explain why pH values are lower on the cell surface than in the surrounding medium or blood and why a pH gradient may prevail from the cell surface to the venous blood or ambient medium (De Hemptinne & Huguenin, 1984). The resulting pH gradient would be larger with rapid  $CO_2$  hydration as expected from the action of extracellular, membrane-bound carbonic anhydrase (e.g. Henry *et al.*, 1997).

The steady state  $P_{CO_2}$  gradient between intra- and extracellular space under resting conditions leads to interstitial pH values between 0.1 and 0.15 units lower than in the venous plasma. Some studies have revealed that changes in intracellular and extracellular  $P_{CO_2}$  may differ, especially during exercise when intracellular  $P_{CO_2}$  surges in poorly perfused tissues such as white muscle. Larger  $P_{CO_2}$  gradients between intra- and extracellular space are likely to develop with increased metabolic rate as during exercise (Pörtner *et al.*, 1991a; Boutilier *et al.*, 1993). In poorly perfused white muscle this trend is exacerbated by glycolytic acidification and titration of bicarbonate stores thus leading to even higher intracellular  $P_{CO_2}$  levels, steeper  $P_{CO_2}$  gradients and lower values of interstitial pH. These considerations emphasise the importance to compile  $P_{CO_2}$  estimates in various body compartments in order to gain a more complete picture of acid-base status, especially during metabolic transition phases or during exercise, both of which involve non steady-state conditions.

### ***Intracellular space***

#### *Isolated cells and organs*

Microelectrode, fluorescent probes and, to some extent,  $^{31}P$ -NMR are most suitable for cellular and subcellular investigations of acid-base parameters in isolated organs and cells (see Schwiening, 1999; Kinsey & Moerland, 1999). At higher levels of complexity, in isolated tissues or transparent animals, fluorescent probes may still be used, as well as  $^{31}P$ -NMR and the homogenate technique (see above). In larger specimens, microelectrode and fluorescent probes are usually no longer applicable, while  $^{31}P$ -NMR and the homogenate techniques are more appropriate.

#### *Whole animals*

The first reliable technique to be used in whole animals was the measurement of the pH-dependent distribution of weak acids and bases, in particular the weak acid dimethyl-oxazolidine-dione (DMO), between the intra- and extracellular spaces (Waddell & Butler, 1959; for a review see Roos & Boron (1981)). In brief, DMO is infused in the animal via an indwelling catheter and  $pH_i$  is calculated from the DMO distribution and the extracellular pH measured by an electrode (Figure 9.9). The use of radiolabelled DMO makes it possible to determine  $pH_i$  invasively in not just one, but various tissues collected from the same individual animal. However, the measurement of rapid  $pH_i$  changes, for instance during muscle activity, is limited by the diffusivity of DMO. Further disadvantages arise from the fact that  $pH_i$  can only be estimated mathematically from extracellular pH, water content of the tissue, concentrations of radiolabelled inulin and DMO in the tissue and plasma to evaluate the intra- and extracellular DMO concentrations. Each of the required measurements has its own inherent errors, which leads to a relatively high variability in the  $pH_i$  values calculated (see above). Therefore, this technique has largely been abandoned. More recently, intracellular pH has been investigated in isolated tissues and whole animals using  $^{31}P$ -NMR (see above) and the homogenate technique (Pörtner *et al.*, 1990).  $^{31}P$ -NMR requires an *in vivo* analysis in the immobilised animal unless the animal exercises in a stable position within the magnet and the spectra are recorded by gating the system (Bock *et al.*, 2008). Prior to the advent of the

homogenate technique the only way to determine intracellular pH during muscular activity of the unrestrained animal was by calculation through pH/bicarbonate analysis from tissue metabolic changes, also considering the exchange of acid-base equivalents between the intra- and extracellular space (Pörtner, 1987a, b).

### *Cellular compartmentalisation*

The pH values determined using homogenates in tissues poor in mitochondria are in good agreement with the mean pH values obtained with DMO (cf. Pörtner *et al.*, 1990) and <sup>31</sup>P-NMR (e.g. Zange *et al.*, 1990). In cells containing a large number of mitochondria, the pH values obtained with these techniques differ depending on the abundance of mitochondria and on the pH gradient maintained between these organelles and the cytoplasm (the contribution of other organelles appears to be less relevant). The contribution of cellular compartments to the average intracellular (homogenate) pH follows their percent contribution to cellular buffering and their relative volume. For reference, mixing two identical volumes of the same buffer values would yield the arithmetic mean of the two pH values. However, the buffer mixtures differ between the two compartments. CO<sub>2</sub> distribution follows weak acid distribution characteristics. In mitochondria, pH is higher and, consequently, the total CO<sub>2</sub> concentration is higher than in the cytosol. CO<sub>2</sub> partial pressures being equal in cytosol (c) and mitochondrial matrix (m), a pH gradient of 1 between the two compartments causes matrix bicarbonate and, accordingly, CCO<sub>2</sub> levels to be approximately 10-fold higher than those in the cytosol (Pörtner *et al.*, 1990, 1991a, b, cf. Figure 9.9):

$$\frac{[\text{HCO}_3^-]_m}{[\text{HCO}_3^-]_c} = 10^{\Delta\text{pH}} \quad (9.9)$$

During the pH measurement in the homogenate, all buffers (including total CO<sub>2</sub> which comprises the CO<sub>2</sub>/bicarbonate buffers) are mixed in a closed system with no exchange of CO<sub>2</sub> between the homogenate and the air. This reduces the influence of the CO<sub>2</sub>/bicarbonate buffer on homogenate pH. Furthermore, the CO<sub>2</sub>/bicarbonate buffer value is pH-dependent and rather low at high mitochondrial pH. This leads to homogenate derived pH<sub>i</sub> values closer to cytosolic pH.

In addition, the comparison of the mean cellular pH obtained by various techniques suggests that mitochondria display non-bicarbonate buffer values lower than the cytosol and do not exert a large influence on mean cellular pH. The concentration and relative contribution of non-bicarbonate buffer substances may thus be different between mitochondrial and cytosolic compartments. Cytosolic actomyosin comprises the major protein fraction in muscle tissue and was found to be 2 to 3 times more important in cellular buffering than soluble protein in trout (Abe *et al.*, 1985). Histidine related compounds such as carnosine and anserine (which are predominantly found in white muscle; Abe *et al.*, 1985) may also prevail in the cytosol. Inorganic phosphate levels are similar or lower in mitochondria than in the cytosol (Soboll & Bünger, 1981). Phosphate is believed to be bound to Ca<sup>2+</sup> in the mitochondrial matrix and would, therefore, be inefficient in mitochondrial buffering.

As a corollary, differences prevail between techniques in their ability to weight compartmental parameters in the determination of mean intracellular pH. Such parameters are volumes, buffer values and pH values (homogenate technique) or volumes and pH differences only (DMO technique). These approaches therefore lead to different pH<sub>i</sub> values when mitochondrial density is high. The homogenate technique provides an estimate of mean intracellular pH emphasising cytosolic pH, whereas the DMO distribution even overestimates mean pH<sub>i</sub> largely due to the distribution characteristics of weak acids. With regards to the <sup>31</sup>P-MRS technique, the localisation of cellular pH is not satisfactorily explained, but this method is also assumed to reflect cytosolic pH (Gadiare *et al.*, 1982).

The fact that the various methods yield different mean values of pH<sub>i</sub> leads to the question, which is the recommended approach to determine mean intracellular Pco<sub>2</sub> in mitochondria-rich cells? Since the concentrations of Cco<sub>2</sub> in the cytosol and the mitochondria are highly different and determined by the characteristics of weak acid distribution (see above), a mean cellular pH value as expected from the analysis of weak acid distribution is required (see above). pH<sub>i</sub> values determined by the DMO technique in individual samples are usually not suitable for this process owing to their large inherent inaccuracy. At present, model considerations of the general difference between homogenate and weak acid derived mean pH<sub>i</sub> values are useful to come to reasonable estimates of mean intracellular Pco<sub>2</sub> values in mitochondria-rich tissues.



### Quantitative aspects

How do we know whether acid-base variables in organismal compartments and in ambient water have been correctly determined? Cross-calibration using various methods is a suitable way of checking consistency. Furthermore, multi-compartmental assessments of proton production by metabolism or during CO<sub>2</sub> exposures provide a quantitative background of acid-base disturbances (e.g. Pörtner, 1987a, b; Pörtner *et al.*, 1998).

### 9.5 Overall suggestions for improvements

Several methods are available to study the relationships between acid-base and metabolic regulation and assess the role of acid-base parameters in modulating metabolic rate, energetic parameters and functional capacity under ocean acidification. This includes a comprehensive analysis of acid-base parameters such as intra- and extracellular (as well as interstitial) pH, bicarbonate and Pco<sub>2</sub> levels taking into account the buffering characteristics of each compartment. Specific patterns of acid-base regulation observed in organisms from various phyla need to be considered building on the hypothesis that the molecular mechanisms of acid-base regulation follow unifying principles across phyla.

The study of acid-base physiology has had its heyday in the 1980s and 1990s. Comparative studies were performed using methods originally developed in medical science. The automation of these techniques for use with human blood disconnected the fields, leaving environmental physiology with equipment which is currently available only second or third hand, if at all. New methods are presently developed. They should replace previous techniques and reach similar standards (e.g. optode systems for pH and Pco<sub>2</sub>). Further miniaturisation of methods for accurate pH measurements in small sample volumes and body compartments would enable to investigate acid-base equilibria in compartments such as those close to calcification sites. Overall, the successful application of the techniques discussed in the present chapter should build on mechanistic hypotheses and look at acid-base parameters as mediators of physiological effects, which can then be upscaled to ecosystem level (Pörtner & Farrell, 2008).

Epithelia: gill, capillary (gill and tissue)					
Water	Blood plasma	Tissue / Cell			
		Membranes: cell, compartments			
		IF (cell surface)	Cytosol	Mitochondria	
Pco <sub>2</sub> (Torr) 0.3	1.6	< 3.4	~ 3.4	~ 3.4	
pH <sub>NBS</sub> 8.1	7.9	> 7.7	> 7.4	<	~ 8.0
HCO <sub>3</sub> <sup>-</sup> 2.3	6.0	6.0	> 2.5	<	~20
β <sub>NB</sub> <1.0	e.g. 5	> 1.0	< e.g. 47	>	e.g. 19

**Figure 9.9** Differences in physicochemical variables between seawater, extracellular fluids and cellular compartments (IF: interstitial fluid, β<sub>NB</sub>: non-bicarbonate buffer value, modified after Pörtner & Sartoris, 1999).

Standardised pH buffers with ionic strengths adjusted to levels similar to those of various body fluids would be ideal for improved accuracy. Standard buffers prepared for analyses in seawater should be suitable to the extracellular fluids of most marine invertebrates (seawater buffers, Dickson *et al.*, 2007; chapter 1 of this guide). If standardised solutions are not commercially available, protocols for buffer preparation must be developed.

In general, the disturbances of the acid-base status caused by ocean acidification can be considered small from the point of view of more traditional physiological analyses, which focus on the identification of contributing mechanisms. They nonetheless become effective on long time scales. Online techniques like NMR appear best suited to monitor acid-base parameters long-term and to minimise disturbance to the living organism. However, it remains to be established which “online” techniques (NMR and fluorescent dyes) can be developed to provide the most suitable assay for the long-term determination of acid-base disturbances under ocean acidification scenarios.

### 9.6 Data reporting

- **Information required to fully describe the experimental procedure:** exposure regime, duration of exposure, water physicochemistry values (levels of e.g. pH, bicarbonate, carbonate, calcium) on physiologically relevant scales.
- **Information required to fully describe the sampling methods:** for example animal acclimation and treatment, sampling procedure for tissues, dye, wavelengths of excitation and emission, time resolution and spatial resolution (whole tissue layer, whole cell, cellular compartment).
- **Metadata:** tissue and cell type, parameters investigated, experimental tools (buffer systems, calibration procedures, ion gradients, pharmacological tools (specific transport inhibitors, inhibitors of carbonic anhydrase).
- **Raw data recorded to characterise an experimental system (no reporting to community necessary):** for example fluorescence intensities vs. wavelength in a region of interest (AU, arbitrary units) and variability between replicates.
- **Data:** for example ratio as a signal which is linearly correlated to pH in a given range (AU), pH, H<sup>+</sup> flux (nmol H<sup>+</sup>/time × membrane area), time constants for pH recovery due to systemic or cellular mechanisms, relative percent change in paired experiments.
- Rate of pH change ( $\tau$ ) during the pH disturbance or recovery phases.
- Comprehensive set of acid-base variables during the quantitative treatment of the acid-base status.

### 9.7 References

- Abe H., Dobson G. P., Hoeger U. & Parkhouse W. S., 1985. Role of histidine-related compounds to intracellular buffering in fish skeletal muscle. *American Journal of Physiology* 249:R449-R454.
- Atkinson D. E. & Bourke E., 1995. pH homeostasis in terrestrial vertebrates; ammonium ion as a proton source. *Advances in Comparative and Environmental Physiology* 22:3-26.
- Bailey D. M., Peck L. S., Bock C. & Pörtner H.-O., 2003. High-energy phosphate metabolism during exercise and recovery in temperate and Antarctic scallops: an in vivo <sup>31</sup>P-NMR study. *Physiological and Biochemical Zoology* 76:622-633.
- Berry L. S., 2001. *Calcification, photosynthesis and calcium uptake in coccolithophores*. PhD Thesis, University of Wales, 267 pp.
- Bickmeyer U., Grube A., Klings K. W. & Köck M., 2008. Ageladine A, a pyrrole-imidazole alkaloid from marine sponges, is a pH sensitive membrane permeable dye. *Biochemical and Biophysical Research Communications* 373:419-422.
- Biemesderfer D., J P., Abu-Alfa A., Exner M., Reilly R., Igarashi P. & Aronson P. S., 1993. NHE3: a Na<sup>+</sup>/H<sup>+</sup> exchanger isoform of renal brush border. *American Journal of Physiology* 265:F736-F742.

- Bleich M., Köttgen M., Schlatter E. & Greger R., 1995. Effect of  $\text{NH}_4^+/\text{NH}_3$  on cytosolic pH and the  $\text{K}^+$  channels of freshly isolated cells from the thick ascending limb of Henle's loop. *Pflügers Archiv - European Journal of Physiology* 429:345-354.
- Bleich M., Warth R., Thiele I. & Greger R., 1998. pH-regulatory mechanisms in in vitro perfused rectal gland tubules of *Squalus acanthias*. *Pflügers Archiv - European Journal of Physiology* 436:248-254.
- Bock C., Lurman G. J., Wittig R. M., Webber D. M. & Pörtner H.-O., 2008. Muscle bioenergetics of speeding fish: In vivo  $^{31}\text{P}$ -NMR studies in a 4.7 T MR scanner with an integrated swim tunnel. *Concepts in Magnetic Resonance Part B (Magnetic Resonance Engineering)* 33B:62-73.
- Bock C., Sartoris F. J. & Pörtner H.-O., 2002. In vivo MR spectroscopy and MR imaging on non-anaesthetized marine fish: techniques and first results. *Magnetic Resonance Imaging* 20:165-172.
- Booth C. E., McDonald D. G. & Walsh P. J., 1984. Acid-base balance in the sea mussel *Mytilus edulis*. 1. Effects of hypoxia and air exposure on hemolymph acid-base status. *Marine Biology Letters* 5:347-358.
- Bothwell J. H. F., Brownlee C., Hetherington A. M., Ng C. K. Y., Wheeler G. L. & McAinsh M. R., 2006. Biolistic delivery of  $\text{Ca}^{2+}$  dyes into plant and algal cells. *Plant Journal* 46:327-335.
- Boutilier R. G., Ferguson R. A., Henry R. P. & Tufts B. L., 1993. Exhaustive exercise in the sea lamprey (*Petromyzon marinus*): relationships between anaerobic metabolism and intracellular acid-base balance. *Journal of Experimental Biology* 178:71-88.
- Boutilier R. G., Iwama G. K., Heming T. A. & Randall D. J., 1985. The apparent pK of carbonic acid in rainbow trout blood plasma between 5°C and 15°C. *Respiratory Physiology* 61:237-254.
- Buck R. P., Rondini S., Covington A. K., Baucke F. G. K., Brett C. M. A., Camoes M. F., Milton M. J. T., Mussini T., Naumann R., Pratt K. W., Spitzer P. & Wilson G. S., 2002. Measurement of pH. Definition, standards, and procedures. *Pure and Applied Chemistry* 74:2169-2200.
- Cameron J. N., 1986. *Principle of physiological measurement*. 278 p. Orlando: Academic Press Orlando.
- Cameron J. N., 1989. Acid-base homeostasis: past and present perspectives. *Physiological Zoology* 62:845-865.
- Daniel H. & Kottra G., 2004. The proton oligopeptide cotransporter family SLC15 in physiology and pharmacology. *Pflügers Archiv - European Journal of Physiology* 447:610-618.
- de Hemptinne A. & Huguenin F., 1984. The influence of muscle respiration and glycolysis on surface and intracellular pH in fibres of the rat soleus. *Journal of Physiology* 347:581-592.
- Dickson A. G., Sabine C. L. & Christian J. R. (Eds.), 2007. Guide to best practices for ocean  $\text{CO}_2$  measurements. *PICES Special Publication* 3:1-191.
- Dixon G. K., Brownlee C. & Merrett M. J., 1989. Measurement of intracellular pH in the coccolithophore *Emiliania huxleyi* using 2',7'-bis-(2-carboxyethyl)-5-(and-6)carboxyfluorescein acetoxymethyl ester and digital imaging microscopy. *Planta* 178:443-449.
- Eisner D. A., Kenning N. A., O'Neill S. C., Pocock G., Richards C. D. & Valdeolmillos M., 1989. A novel method for absolute calibration of intracellular pH indicators. *Pflügers Archiv - European Journal of Physiology* 413:553-558.
- Farinas J. & Verkman A. S., 1999. Receptor-mediated targeting of fluorescent probes in living cells. *Journal of Biological Chemistry* 274:7603-7606.
- Ferguson R. A., Kieffer J. D. & Tufts B. L., 1993. The effects of body size on the acid-base and metabolite status in the white muscle of rainbow trout before and after exhaustive exercise. *Journal of Experimental Biology* 180:195-207.
- Frederich M. & Pörtner H.-O., 2000. Oxygen limitation of thermal tolerance defined by cardiac and ventilatory performance in spider crab, *Maja squinado*. *American Journal of Physiology* 279:R1531-R1538.
- Fujita M., Nakao Y., Matsunaga S., Seiki M., Itoh Y., Yamashita J., van Soest R. W. M. & Fusetani N., 2003. Bioactive marine metabolites, Part 124. Ageladine A: an antiangiogenic matrix metalloproteinase inhibitor from the marine sponge *Agelas nakamurai*. *Journal of the American Chemical Society* 125:15700-15701.
- Fyhn H. J. & Costlow J. D., 1975. Anaerobic sampling of body fluids in bivalve molluscs. *Comparative Biochemistry and Physiology - Part A* 52:265-268.

## Part 3: Measurements of CO<sub>2</sub>-sensitive processes

- Gadian D. G., Radda G. K., Dawson M. J. & Wilkie D. R., 1982. pH<sub>i</sub> measurements of cardiac and skeletal muscle using <sup>31</sup>P-NMR. In: Nuccitelli R. & Deamer D. W. (Eds.), *Intracellular pH: Its measurement, regulation and utilization in cellular functions*, pp. 61-77. New York: Alan R. Liss Inc.
- Garcia-Martin M. L., Martinez G. V., Raghunand N., Sherry A. D., Zhang S. R. & Gillies R. J., 2006. High resolution pH<sub>c</sub> imaging of rat glioma using pH-dependent relaxivity. *Magnetic Resonance in Medicine* 55:309-315.
- Gibbon B. C. & Kropf D. L., 1994. Cytosolic pH gradients associated with tip growth. *Science* 263:1419-1421.
- Gillies R. J., Liu Z. & Bhujwala Z., 1994. <sup>31</sup>P-MRS measurements of extracellular pH of tumors using 3-aminopropylphosphonate. *American Journal of Physiology* 267:C195-C203.
- Gillies R. J., Raghunand N., Garcia-Martin M. L. & Gatenby R. A., 2004. pH imaging. A review of pH measurement methods and applications in cancers. *IEEE Engineering in Medicine and Biology* 23:57-64.
- Gutowska M. & Melzner F., 2009. Abiotic conditions in cephalopod (*Sepia officinalis*) eggs: embryonic development at low pH and high pCO<sub>2</sub>. *Marine Biology* 156:515-519.
- Gutowska, M.A., Melzner F., Langenbuch M., Bock C., Claireaux G. & Pörtner H.O.. Acid-base regulatory ability of the cephalopod (*Sepia officinalis*) in response to environmental hypercapnia. *Journal of Comparative Physiology – B* DOI 10.1007/s00360-009-0412-y
- Haber F. & Klemensiewicz Z., 1909. Über elektrische Phasengrenzkräfte. *Zeitschrift für Physikalische Chemie* 64:385-391.
- Hardewig I., Pörtner H.-O. & Grieshaber M. K., 1994. Interactions of anaerobic propionate formation and acid-base status in *Arenicola marina*: an analysis of propionyl-CoA-carboxylase. *Physiological Zoology* 67:892-909.
- Haugland R. P., Spence M. T. Z., Johnson I. D. & Basey A., 2005. *The handbook: a guide to fluorescent probes and labeling technologies*. 1126 p. Eugene, Oregon: Molecular Probes.
- Heisler N., 1975. Intracellular pH of isolated rat diaphragm muscle with metabolic and respiratory changes of extracellular pH. *Respiratory Physiology* 23:243-255.
- Heisler N., 1989. Parameters and methods in acid-base physiology. In: Bridges C. R. & Butler P. J. (Eds.) *Techniques in comparative respiratory physiology*, pp. 305-332. Cambridge: Cambridge University Press.
- Heisler N. & Neumann P., 1980. The role of physicochemical buffering and of bicarbonate transfer processes in intracellular pH regulation in response to changes of temperature in the larger spotted dogfish (*Scyliorhinus stellaris*). *Journal of Experimental Biology* 85:99-110.
- Heisler N. & Piiper J., 1971. The buffer value of rat diaphragm muscle tissue determined by PCO<sub>2</sub> equilibration of homogenates. *Respiratory Physiology* 12:169-178.
- Heisler N., 1984. Acid-base regulation in fishes. In: Hoar W. S. & Randall D. J. (Eds.), *Fish Physiology*, vol. XA, pp. 315-401. New York: Academic Press.
- Heisler N., 1986. Buffering and transmembrane ion transfer processes. In: Heisler N. (Ed.), *Acid-base regulation in animals*, pp. 3-47. Amsterdam: Elsevier Biomedical Press.
- Henry R. P., Wang Y. X. & Wood C. M., 1997. Carbonic anhydrase facilitates CO<sub>2</sub> and NH<sub>3</sub> transport across the sarcolemma of trout white muscle. *American Journal of Physiology* 272:R1754-R1761.
- Hochachka P. W. & Mommsen T. P., 1983. Protons and anaerobiosis. *Science* 219:1391-1397.
- James-Kracke M. R., 1992. Quick and accurate method to convert BCECF fluorescence to pH<sub>i</sub> calibration in three different types of cell preparations. *Journal of Cellular Physiology* 151:596-603.
- Kinsey S. T. & Moreland T., 1999. The use of nuclear magnetic resonance for examining pH in living systems. In: Taylor E. W., Egington S. & Raven J. A. (Eds.), *Regulation of tissue pH in plants and animals. SEB Seminar Series*, pp. 45-67. Cambridge: Cambridge University Press.
- Kneen M., Farinas J., Li Y. X. & Verkman A. S., 1998. Green fluorescent protein as a noninvasive intracellular pH indicator. *Biophysical Journal* 74:1591-1599.
- Kosch U., Klimant I., Werner T. & Wolfbeis O. S., 1998. Strategies to design pH optodes with luminescence decay times in the sensorsecond time regime. *Analytical Chemistry* 362:73-78.

- Kost G. J., 1990. pH standardization for phosphorus-31 magnetic resonance heart spectroscopy at different temperatures. *Magnetic Resonance in Medicine* 14:496-506.
- Kotyk A. & Slavik J., 1989. *Intracellular pH and its measurement*. 192 p. Boca Raton: CRC Press.
- Kratz L., 1950. *Die Glaselektrode und ihre Anwendungen*. 380 p. Frankfurt: Verlag Dr. Dietrich Steinkopff.
- Krause U. & Wegener G., 1996. Exercise and recovery in frog muscle: metabolism of PCr, adenine nucleotides, and related compounds. *American Journal of Physiology* 270:R811-R820.
- Lannig G., Bock C., Sartoris F. J. & Pörtner H.-O., 2004. Oxygen limitation of thermal tolerance in cod, *Gadus morhua* L., studied by magnetic resonance imaging and on-line venous oxygen monitoring. *American Journal of Physiology* 287:R902-R910.
- Lenfant C. & Aucott C., 1966. Measurement of blood gases by gas chromatography. *Respiratory Physiology* 1:398-407.
- Liebsch G., Klimant I., Krause C. & Wolfbeis O. S., 2001. Fluorescent imaging of pH with optical sensors using time domain dual lifetime referencing. *Analytical Chemistry* 73:4354-4363.
- Madden A., Leach M. O., Sharp J.C., Collins D. J., Easton D., 1991. A quantitative analysis of the accuracy of in vivo pH measurements with <sup>31</sup>P NMR spectroscopy: assessment of pH measurement methodology. *NMR in Biomedicine* 4: 1-11.
- Madiedo G., Sciacca R., Hause L. & Sasse E., 1982. Use of syringes containing dry (lyophilized) heparin in sampling blood for pH measurement and blood-gas analysis. *Clinical Chemistry* 28:1727-1729.
- Meketa M. L. & Weinreb S. M., 2006. Total synthesis of ageladine A, an angiogenesis inhibitor from the marine sponge *Agelas nakamurai*. *Organic Letters* 8:1443-1446.
- Meketa M. L., Weinreb S. M., Nakao Y. & Fusetani N., 2007. Application of a 6π-1-azatriene electrocyclization strategy to the total synthesis of the marine sponge metabolite ageladine A and biological evaluation of synthetic analogues. *Journal of Organic Chemistry* 72:4892-4899.
- Meketa M. L. & Weinreb S. M., 2007. A convergent total synthesis of the marine sponge alkaloid ageladine A via a strategic 6π-2-azatriene electrocyclization. *Tetrahedron* 63:9112-9119.
- Melzner F., 2005. *Systemic investigations on the physiology of temperature tolerance in the common cuttlefish Sepia officinalis*. PhD Thesis, University of Bremen, 234 p.
- Melzner F., Bock C. & Pörtner H.-O., 2006. Critical temperatures in the cephalopod *Sepia officinalis* investigated using in vivo <sup>31</sup>P-NMR spectroscopy. *Journal of Experimental Biology* 209:891-906.
- Melzner F., Bock C. & Pörtner H.-O., 2006. Temperature-dependent oxygen extraction from the ventilatory current and the costs of ventilation in the cephalopod *Sepia officinalis*. *Journal of Comparative Physiology B* 176:607-621.
- Metzger R., Sartoris F. J., Langenbuch M. & Pörtner H.-O., 2007. Influence of elevated CO<sub>2</sub> concentrations on thermal tolerance of the edible crab *Cancer pagurus*. *Journal of Thermal Biology* 32:144-151.
- Michaelidis B., Ouzounis C., Paleras A. & Pörtner H.-O., 2005. Effects of long-term moderate hypercapnia on acid-base balance and growth rate in marine mussels (*Mytilus galloprovincialis*). *Marine Ecology Progress Series* 293:109-118.
- Michard E., Dias P. & Feijo J. A., 2008. Tobacco pollen tubes as cellular models for ion dynamics: improved spatial and temporal resolution of extracellular flux and free cytosolic concentration of calcium and protons using pHluorin and YC3.1 CaMeleon. *Sexual Plant Reproduction* 21:169-181.
- Moon R. B. & Richards J. H., 1973. Determination of intracellular pH by <sup>31</sup>P Magnetic Resonance. *Journal of Biological Chemistry* 248:7276-7278.
- Musgrove E., Rugg C. & Hedley D., 1986. Flow cytometric measurement of cytoplasmic pH – a critical evaluation of available fluorochromes. *Cytometry* 7:347-355.
- Palmer A. E. & Tsien R. Y., 2006. Measuring calcium signaling using genetically targetable fluorescent indicators. *Nature Protocols* 1:1057-1065.
- Poenie M., 1990. Alteration of fura-2 fluorescence by viscosity – a simple correction. *Cell Calcium* 11:85.
- Pörtner H.-O., 1987. Anaerobic metabolism and changes in acid-base status: quantitative interrelationships and pH regulation in the marine worm *Sipunculus nudus*. *Journal of Experimental Biology* 131:89-105.

## Part 3: Measurements of CO<sub>2</sub> - sensitive processes

- Pörtner H.-O., 1987. Contributions of anaerobic metabolism to pH regulation in animal tissues: theory. *Journal of Experimental Biology* 131:69-87.
- Pörtner H.-O., 1989. The importance of metabolism in acid base regulation and acid base methodology. *Canadian Journal of Zoology* 67:3005-3017.
- Pörtner H.-O., 1990. An analysis of the effects of pH on oxygen binding by squid (*Illex illecebrosus*, *Loligo pealei*) haemocyanin. *Journal of Experimental Biology* 150:407-424.
- Pörtner H.-O., 1990. Determination of intracellular buffer values after metabolic inhibition by fluoride and nitrilotriacetic acid. *Respiratory Physiology* 81:275-288.
- Pörtner H.-O., 1993. Multicompartmental analyses of acid-base and metabolic homeostasis during anaerobiosis: invertebrate and lower vertebrate examples. In: Hochachka P. W., Lutz P. L., Sick T., Rosenthal M. & van den Thillart G. (Eds.), *Surviving hypoxia: mechanisms of control and adaptation*, pp. 139-156. Boca Raton: CRC Press.
- Pörtner H.-O., Bock C. & Reipschläger A., 2000. Modulation of the cost of pH<sub>i</sub> regulation during metabolic depression: A <sup>31</sup>P-NMR study in invertebrate (*Sipunculus nudus*) isolated muscle. *Journal of Experimental Biology* 203:2417-2428.
- Pörtner H.-O., Boutilier R. G., Tang Y. & Toews D. P., 1990. Determination of intracellular pH and PCO<sub>2</sub> after metabolic inhibition by fluoride and nitrilotriacetic acid. *Respiratory Physiology* 81:255-274.
- Pörtner H.-O. & Farrell A. P., 2008. ECOLOGY: Physiology and climate change. *Science* 322:690-692.
- Pörtner H.-O., Finke E. & Lee P. G., 1996. Metabolic and energy correlates of intracellular pH in progressive fatigue of squid (*L. brevis*) mantle muscle. *American Journal of Physiology* 271:R1403-R1414.
- Pörtner H.-O., Hardewig I., Sartoris F. J. & van Dijk P., 1998. Energetic aspects of cold adaptation: critical temperatures in metabolic, ionic and acid-base regulation? In: Pörtner H. O. & Playle R. (Eds.), *Cold ocean physiology*, pp. 88-120. Cambridge: Cambridge University Press.
- Pörtner H.-O., Langenbuch M. & Michaelidis B., 2005. Synergistic effects of temperature extremes, hypoxia, and increases in CO<sub>2</sub> on marine animals: from Earth history to global change. *Journal of Geophysical Research- Oceans* 110, C09S10. doi:10.1029/2004JC002561.
- Pörtner H.-O., MacLachy L. M. & Toews D. P., 1991. Acid-base regulation in the toad *Bufo marinus* during environmental hypoxia. *Respiratory Physiology* 85:217-230.
- Pörtner H.-O., Reipschläger A. & Heisler N., 1998. Acid-base regulation, metabolism and energetics in *Sipunculus nudus* as a function of ambient carbon dioxide level. *Journal of Experimental Biology* 201:43-55.
- Pörtner H.-O. & Sartoris F. J., 1999. Invasive studies of intracellular acid-base parameters: quantitative analyses during environmental and functional stress. In: Taylor E. W., Egington S. & Raven J. A. (Eds.), *Regulation of tissue pH in plants and animals. SEB Seminar Series*, pp. 68-98. Cambridge: Cambridge University Press.
- Pörtner H.-O., Webber D. M., Boutilier R. G. & O'Dor R. K., 1991. Acid-base regulation in exercising squid (*Illex illecebrosus*, *Loligo pealei*). *American Journal of Physiology* 261:R239-R246.
- Pörtner H.-O., 1995. pH homeostasis in terrestrial vertebrates: a comparison of traditional and new concepts. *Advances in Comparative and Environmental Physiology* 22:51-62.
- Prakash E. S., Robergs R. A., Miller B. F., Gladden L. B., Jones N., Stringer W. W., Wasserman K., Moll W., Gros G., Rowlands D. S., Sahlin K. & Beneke R., 2008. Comments on point: counterpoint lactic acid is/ is not the only physicochemical contributor to the acidosis of exercise. *Journal of Applied Physiology* 105:363-367.
- Reeves R. B., 1972. An imidazole alaphastat hypothesis for vertebrate acid-base regulation: Tissue carbon dioxide content and body temperature in bullfrogs. *Respiratory Physiology* 14:219-236.
- Reeves R. B., 1985. Alaphastat regulation of intracellular acid-base state? In: Gilles R. (Ed.), *Circulation, respiration, and metabolism*, pp. 414-423. Berlin: Springer-Verlag.
- Reipschläger A. & Pörtner H.-O., 1996. Metabolic depression during environmental stress: The role of extracellular versus intracellular pH in *Sipunculus nudus*. *Journal of Experimental Biology* 199:1801-1807.

- Rink T. J., Tsien R. Y. & Pozzan T., 1982. Cytoplasmic pH and free  $Mg^{2+}$  in lymphocytes. *Journal of Cell Biology* 95:189-196.
- Robergs R. A., Ghiasvand F. & Parker D., 2004. Biochemistry of exercise-induced metabolic acidosis. *American Journal of Physiology* 287:R502-R516.
- Roberts J. K. M., Wade-Jardetzky N. & Jardetzky O., 1981. Intracellular pH measurements by  $^3P$  nuclear magnetic resonance. Influence of factors other than pH on  $^3P$  chemical shifts. *Biochemistry* 20:5389-5394.
- Roos A. & Boron W. F., 1981. Intracellular pH. *Physiological Reviews* 61:296-434.
- Sankaranarayanan S., De Angelis D., Rothman J. E. & Ryan T. A., 2000. The use of pHluorins for optical measurements of presynaptic activity. *Biophysical Journal* 79:2199-2208.
- Sartoris F. J., Bock C., Serendero I., Lannig G. & Pörtner H.-O., 2003. Temperature-dependent changes in energy metabolism, intracellular pH and blood oxygen tension in the Atlantic cod, *Gadus morhua*. *Journal of Fish Biology* 62:1239-1253.
- Schwiening C. J., 1999. Measurement of intracellular pH: a comparison between ion-sensitive electrodes and fluorescent dyes. In: Taylor E. W., Egington S. & Raven J. A. (Eds.), *Regulation of tissue pH in plants and animals. SEB Seminar Series*, pp. 1-17. Cambridge: Cambridge University Press.
- Shengule S. R. & Karuso P., 2006. Concise total synthesis of the marine natural product ageladine A. *Organic Letters* 8:4083-4084.
- Siggaard-Andersen O., 1974. *The acid-base status of the blood*. 229 p. Baltimore: William & Wilkins.
- Soboll S. & Bünger R., 1981. Compartmentation of adenine nucleotides in the isolated working guinea pig heart stimulated by noradrenaline. *Hoppe Seylers Z Physiol Chem* 362:125-132.
- Somero G. N., 1986. Protons, osmolytes and the fitness of the internal milieu for protein function. *American Journal of Physiology* 251:R197-R213.
- Spicer J. I., Taylor A. C. & Hill A. D., 1988. Acid-base status in the sea-urchins *Psammechinus miliaris* and *Echinus esculentus* (Echinodermata, Echinoidea) during emersion. *Marine Biology* 99:527-534.
- Tang Y. & Boutilier R. G., 1991. White muscle intracellular acid-base and lactate status following exhaustive exercise: a comparison between freshwater- and seawater-adapted rainbow trout. *Journal of Experimental Biology* 156:153-171.
- Thatje, S., Calcagno, J. A., Lovrich, G. A., Sartoris, F. J., Anger, K. (2003). Extended hatching periods in the subantarctic lithodid crabs *Lithodes santolla* and *Paralomis granulosa* (Crustacea: Decapoda: Lithodidae), *Helgoland Marine Research*, 57:110-113.
- Thomas J. A., Buchsbaum R. N., Zimniak A. & Racker E., 1979. Intracellular pH measurements in Ehrlich ascites tumor cells utilizing spectroscopic probes generated in situ. *Biochemistry* 18:2210-2218.
- Trapp S., Luckermann M., Brooks P. A. & Ballanyi K., 1996. Acidosis of rat dorsal vagal neurons in situ during spontaneous and evoked activity. *Journal of Physiology* 496:695-710.
- van Sluis R., Bhujwala Z. M., Raghunand N., Ballesteros P., Alvarez J., Cerdán S., Galons J. P. & Gillies R. J., 1999. In vivo imaging of extracellular pH using  $^1H$ -MRSI. *Magnetic Resonance in Medicine* 41:743-750.
- Waddell W. J. & Butler T. C., 1959. Calculation of intracellular pH from the distribution of 5,5-dimethyl-2,4-oxazolidine-dione (DMO). Application to skeletal muscle of the dog. *Journal of Clinical Investigation* 38:720-729.
- Walsh P. J. & Milligan C. L., 1989. Coordination of metabolism and intracellular acid-base status: ionic regulation and metabolic consequences. *Canadian Journal of Zoology* 67:2994-3004.
- Welker T. L., Lim C. E., Aksoy M. & Klesius P. H., 2007. Effect of buffered and unbuffered tricaine methanesulfonate (ms-222) at different concentrations on the stress responses of channel catfish (*Ictalurus punctatus* Rafinesque). *Journal of Applied Aquaculture* 19:1-18.
- Wiseman R. W. & Ellington W. R., 1989. Intracellular buffering capacity in molluscan muscle: superfused muscle vs. homogenates. *Physiology and Zoology* 62:541-558.
- Wolfbeis O. S. (Ed.), 1991. *Fiber Optic Chemical Sensors and Biosensors*, Vol. 1 & 2, 359 p. Boca Raton: CRC Press.

- Wollenberger A., Ristau O. & Schoffa G., 1960. Eine einfache Technik der extrem schnellen Abkühlung größerer Gewebestücke. *Pflügers Archiv - European Journal of Physiology* 270:399-412.
- Zange J., Pörtner H.-O., Jans A. W. H. & Grieshaber M. K., 1990. The intracellular pH of a molluscan smooth muscle during a contraction catch relaxation cycle as estimated by the distribution of  $^{14}\text{C}$ -DMO and by  $^{31}\text{P}$ -NMR spectroscopy. *Journal of Experimental Biology* 150:81-93.
- Zeebe R. E. & Wolf-Gladrow D. A., 2001. *CO<sub>2</sub> in seawater: equilibrium, kinetics, isotopes*. 346 p. Amsterdam: Elsevier.
- Zhao J. H., Hogan E. M., Bevensee M. O. & Boron W. F., 1995. Out-of-equilibrium CO<sub>2</sub>/HCO<sub>3</sub><sup>-</sup> solutions and their use in characterizing a new K/HCO<sub>3</sub> cotransporter. *Nature* 374(6523): 636-639.
- Zhou J. Y., Payen J. F., Wilson D. A., Traystman R. J. & van Zijl P. C. M., 2003. Using the amide proton signals of intracellular proteins and peptides to detect pH effects in MRI. *Nature Medicine* 9:1085-1090.



### 10 Studies of metabolic rate and other characters across life stages

Hans-Otto Pörtner<sup>1</sup>, Sam Dupont<sup>2</sup>, Frank Melzner<sup>3</sup>, Daniela Storch<sup>1</sup> and Mike Thorndyke<sup>2,4</sup>

<sup>1</sup>Alfred Wegener Institute for Polar and Marine Research, Germany

<sup>2</sup>Department of Marine Ecology - Kristineberg, University of Gothenburg, Sweden

<sup>3</sup>Leibniz Institute of Marine Sciences (IFM-GEOMAR), Germany

<sup>4</sup>Royal Swedish Academy of Sciences, University of Gothenburg, Sweden

#### 10.1 Introduction

Environmental stressors like hypoxia, extreme temperature or elevated partial pressure of CO<sub>2</sub> as during ocean acidification scenarios may cause disturbances in acid-base status of an organism. Shifting pH values in different body compartments are widely accepted to affect individual physiological functions. Frequently, such effects are visible in changes in whole organism physiological rates, like growth rates and metabolic variables, but can also be detected at the level of protein/gene expression. Acid-base and metabolic regulation are interdependent processes such that changes in pH can affect metabolic rate, the mode of catabolism and energetic parameters (Pörtner, 1989).

Functional scope and thus metabolic features vary depending on the developmental stage and lifestyle of an organism. The role of acid-base regulation in metabolic regulation is likely species-specific, and within species, specific for the developmental and life stages of a species. Analyses and comparison of physiological processes and other functional characteristics between species and between life stages of a species over time therefore rely on the clear identification of the age, life stage or physiological status of compared individuals. Such comparisons frequently involve the study of metabolic rate, however, the principal approach when looking at the effect of pH on a process in different life stages is the same for all of these processes.

This chapter aims to provide keys on how to define the frame of reference for any process influenced by pH over time and, then, to provide methodology for metabolic studies, as an example. Other methodological aspects such as culturing methods and parameters that may influence any impact observed (e.g. food availability, maternal effect, intra-specific variations, see Qiu & Quian (1997)) are beyond the scope of this chapter. Experimental design and methods should be adapted to each particular species and question (see chapter 7). Note that the analysis of acid-base variables is addressed in chapter 9.

One key variable to consider when choosing the relevant methodology for studies of metabolic or other processes during ontogeny is a developmental signpost (e.g. age). Furthermore, it needs to be considered that mode of life and thus the level of spontaneous activity may change during ontogeny of the individuals analysed (e.g. pelagic larvae and benthic adults) as much as their age and body size change. Adequate precaution needs to be taken to assure that metabolic variables and other characters can be defined for specific life stages or developmental stages and also be compared between them.

#### 10.2 Definition of a frame of reference: studying specific characters across life stages

The performance of an organism is dependent on intrinsic and extrinsic factors. Indeed, intrinsic processes such as metabolism or gene/protein expression are likely to vary with life stages (e.g. developmental stages) and body size or age and, in addition, will be highly influenced by environmental conditions such as temperature (e.g. during seasonal variations), food availability or CO<sub>2</sub> exposure. For example, there is a growing body of evidence indicating that when raised under conditions of ocean acidification expected in the near future, larval stages develop more slowly (Dupont & Thorndyke, 2008; Dupont *et al.*, 2010) while juveniles and adults can either grow slower (e.g. Shirayama & Thornton, 2005) or faster (e.g. Gooding *et al.*, 2009). This is complicated by interactions with other factors such as temperature, which is well known to impact growth and development

## Part 3: Measurements of CO<sub>2</sub> - sensitive processes

processes in itself. The interaction of various factors can best be studied when using, for example, temperature sensitivity as a matrix and a unifying physiological concept such as the concept of oxygen- and capacity-limited thermal tolerance (OCLT) in animals to integrate the specific effects of temperature with those of other environmental factors like hypoxia or ambient hypercapnia (ocean acidification) (Pörtner, 2010).

The phenomenon of environmental effects on time-dependent functions can lead to a classic experimental design problem: how to assess the impact of a tested parameter (e.g. pH) on a given process (e.g. gene expression or metabolic rate) at a certain time or stage, while this parameter also influences the rates of growth and/or development and thereby leads to different stages at a given time in controls and experimental specimens? In other words, how can we discriminate the real effect of the parameter from phenomena which can result in differences due to differential growth or development?

*Age* (i.e. time post fertilisation) is still frequently used as the reference scale, for example in pH studies on larval development (see O'Donnell *et al.* (2009) and O'Donnell *et al.* (2010) for recent examples in the ocean acidification field). However, when the tested parameter influences growth and developmental rate, using *age* as the reference scale may introduce inaccuracies and even invalidate conclusions as a developmental stage defined in the controls may not be reached at the same age in exposed specimens, especially when only one time point is used.

For example, assume we want to see if low pH influences the expression of the gene X during the development of a sea urchin (Figure 10.1). In the control, this gene is activated only during a limited time window, post fertilisation (e.g. during 2 days when the larvae reach the pluteus stage). Under low pH conditions, development is slower and it will take one more day to reach the same pluteus stage.

In this theoretical example, using age as the reference frame, the investigator may decide to compare the expression of the gene X at day 2 in two tested conditions (control and low pH). S/he will conclude erroneously

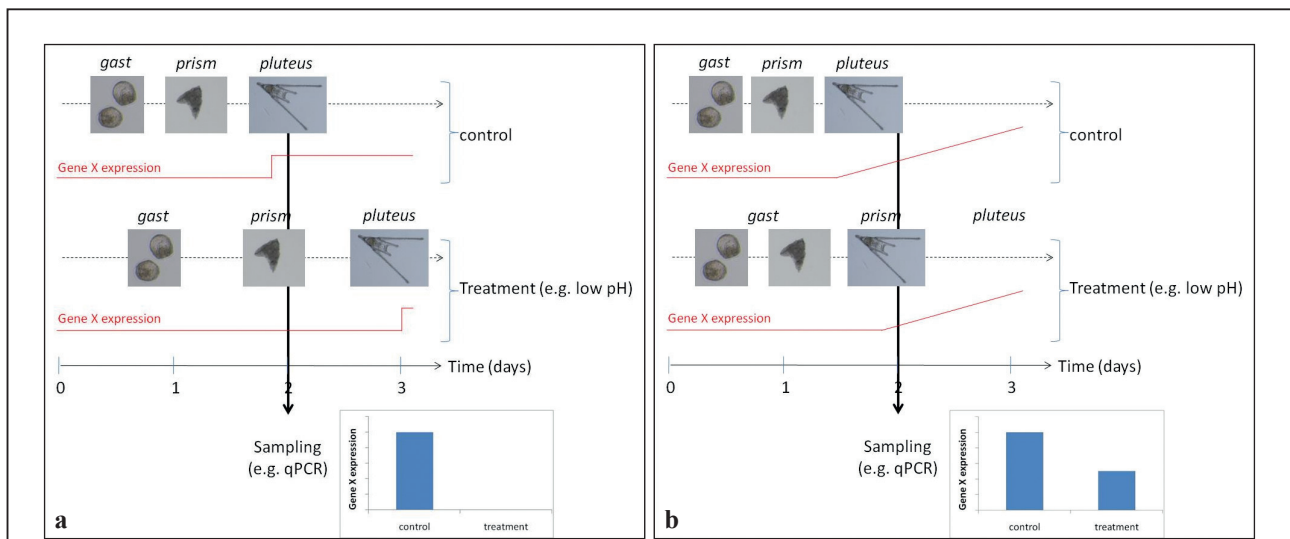

**Figure 10.1** Theoretical experiment investigating the expression of a gene X during the development of a sea urchin under control or a treatment inducing a reduction in growth rate (e.g. low pH; Dupont & Thorndyke, 2009). Under the treatment, it takes more time to reach the same developmental signposts. In the scenario a), the gene is first expressed (on or off) when the larvae reach the pluteus stage (day 2 in control, day 3 in treatment). As a consequence, gene expression at day 2 is showing expression of the gene X only in the control. In the scenario b), the impact of the treatment is more subtle and, at day 2, the pluteus stage is reached in both conditions. However, pluteus larvae are slightly larger in the control. This small difference in size is translated into a small, quantitative difference in gene X expression. In both scenarios, the conclusion may be that the treatment induces a down-regulation of the gene X at day 2.

that the treatment induces a difference in gene expression (absence of, or lower, expression at low pH compared to “normal” expression in the control).

In conclusion, when the tested parameter influences growth and developmental rates, *age* is not the only relevant scale and one should rather use a reference frame of non-dimensional events (e.g. stages, *developmental signposts*) rather than time *per se*.

This could partly be resolved by following the dynamics of a given process (e.g. the evolution of physiological state over time; Meyer *et al.*, 2007) rather than choosing comparisons at discrete observation points. In order to be widely applicable in different research groups so as to allow comparison between studies, a *frame of reference* should be simple, easy to measure and provide a strong predictive capacity.

The definition of the frame of reference is often based on *developmental signposts* and can be straightforward for discrete processes (e.g. larval development in crustaceans; Figure 10.2a) but much more complicated for continuous (e.g. limb regeneration in brittlestars; Figure 10.2b) or semi-continuous ones (e.g. larval development in echinoderms).

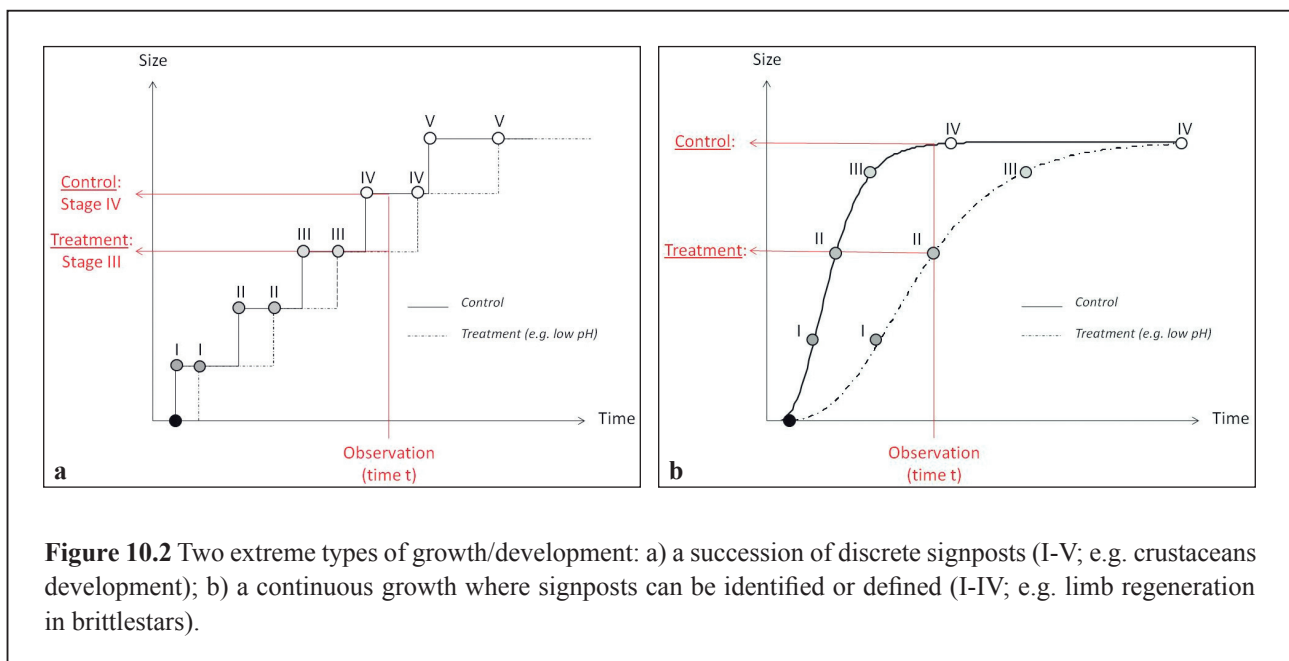

**Figure 10.2** Two extreme types of growth/development: a) a succession of discrete signposts (I-V; e.g. crustaceans development); b) a continuous growth where signposts can be identified or defined (I-IV; e.g. limb regeneration in brittlestars).

Crustaceans have a rigid exoskeleton, which must be shed to allow the animal to grow (ecdysis or molting). As a consequence, crustaceans usually develop through a sequence of planktonic larval forms. For example, the copepod *Acartia clausi* develops through a sequence of 6 nauplii and 5 copepodite stages before reaching the adult stage. These developmental stages are obvious and represent relevant developmental signposts classically taken into account during physiological and molecular studies (e.g. Calcagno *et al.*, 2003; Thatje *et al.*, 2004; Leandro *et al.*, 2006). The developmental clock is influenced by temperature as one of the main environmental parameters. Larvae develop faster at higher temperatures (e.g. shorter stage duration in *Acartia clausi*; Leandro *et al.*, 2006). To assess the impact of temperature on any given process (e.g. biomass in the stone crab *Paralomis granulose*; Calcagno *et al.*, 2003), the investigator should then compare the same *stage* rather than the same *age*.

The problem is more complicated when the studied process is continuous (no obvious signposts) or semi-continuous (signposts but continuous growth). Development in echinoderms is a good example of a semi-continuous process. In striking contrast with crustaceans, echinoderm larvae have either an internal skeleton (e.g. sea urchin) or no skeleton (e.g. sea star) allowing continuous growth. For example, the sea star *Asterias rubens* develops through few developmental stages (first, a bipinnaria larva, followed by a brachiolaria larva

## Part 3: Measurements of CO<sub>2</sub> - sensitive processes

that metamorphoses into a juvenile). However, each stage grows continuously and neither age nor obvious developmental signposts are sufficient to allow accurate comparison and assess the impact of tested parameters (see Figure 10.1b).

This is even more difficult with continuous processes, although for some of these processes it is possible to identify some developmental signposts. For example, larval growth of the pelagic tunicate *Oikopleura dioica* is continuous and includes some arbitrary developmental signposts: early hatchling, mid-hatchling, late hatchling and tailshift (Cañestro *et al.*, 2005). However, this simple staging method is not sufficient to assess the complexity of developmental progression at the cellular and molecular levels, and more accurate frames of reference have been recently developed (e.g. endostyle cell growth; Troedsson *et al.*, 2007). It is important to notice that such reference signposts are lacking for many taxa and processes.

Limb regeneration in the brittlestar *Amphiura filiformis* is another example of a continuous process. After amputation of an arm, new tissues arise from active proliferation of migratory undifferentiated cells (amoebocytes and coelomocytes), which accumulate in a blastema. The new arm extends from the tip with segmental maturity occurring in a temporally regulated fashion and proximal-distal direction until a full length and fully differentiated arm has regrown. The regeneration rate appears to be highly dependent on extrinsic environmental factors (e.g. the regenerated arm grows faster at higher temperatures (Thorndyke *et al.*, 2003) or lower pH (Wood *et al.*, 2008)), but also on intrinsic factors (e.g. length of the lost part of the arm (Dupont & Thorndyke, 2006)). In the regeneration field, time of regeneration is the classical parameter used in molecular, cellular, histological, dynamics and ecological studies. However, regenerates of the same size and/or same regeneration time can present very different characteristics in terms of differentiation and functional recovery, and vary according to the position of autotomy along the arm and/or environmental conditions. In consequence, the use of time of regeneration is inappropriate, especially in dynamic studies (Dupont & Thorndyke, 2006). One approach includes the definition of arbitrary signposts, such as level of differentiation of the regenerating arm (<10%, 50% and >90% of differentiation).

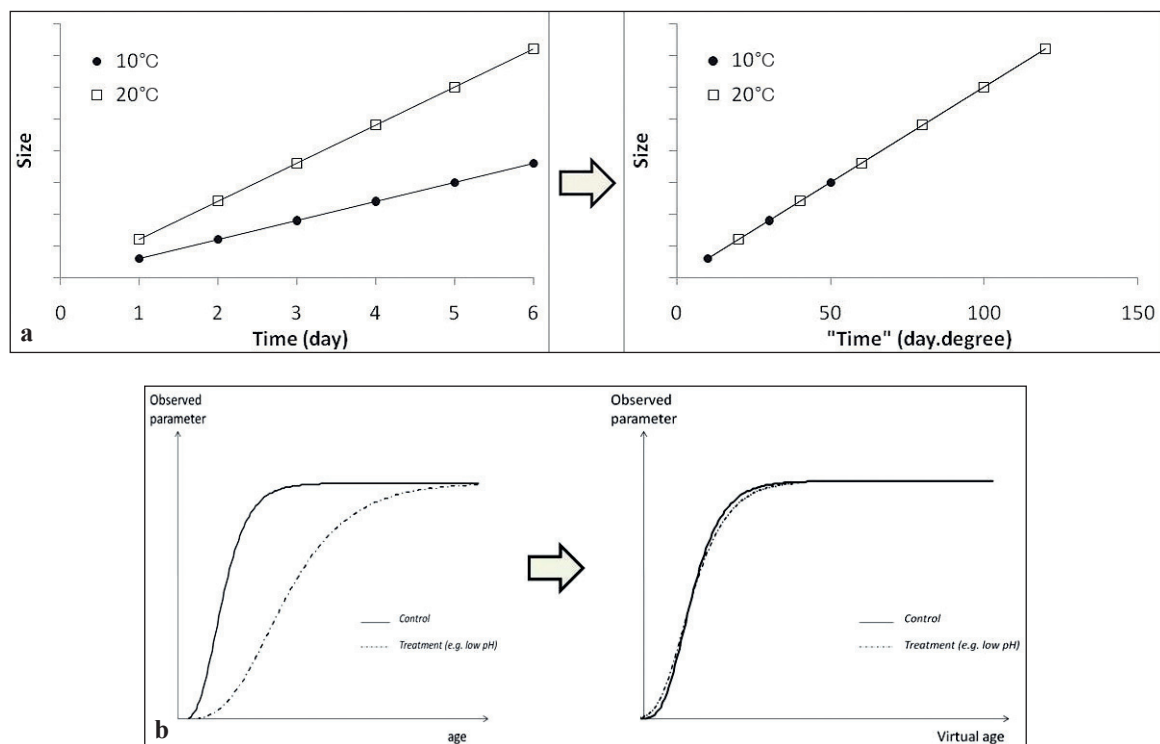

**Figure 10.3** Theoretical example showing how to standardise data integrating the impact of a given parameter on growth and/or developmental rates: a) standardised time using a time × temperature scale; b) virtual age.

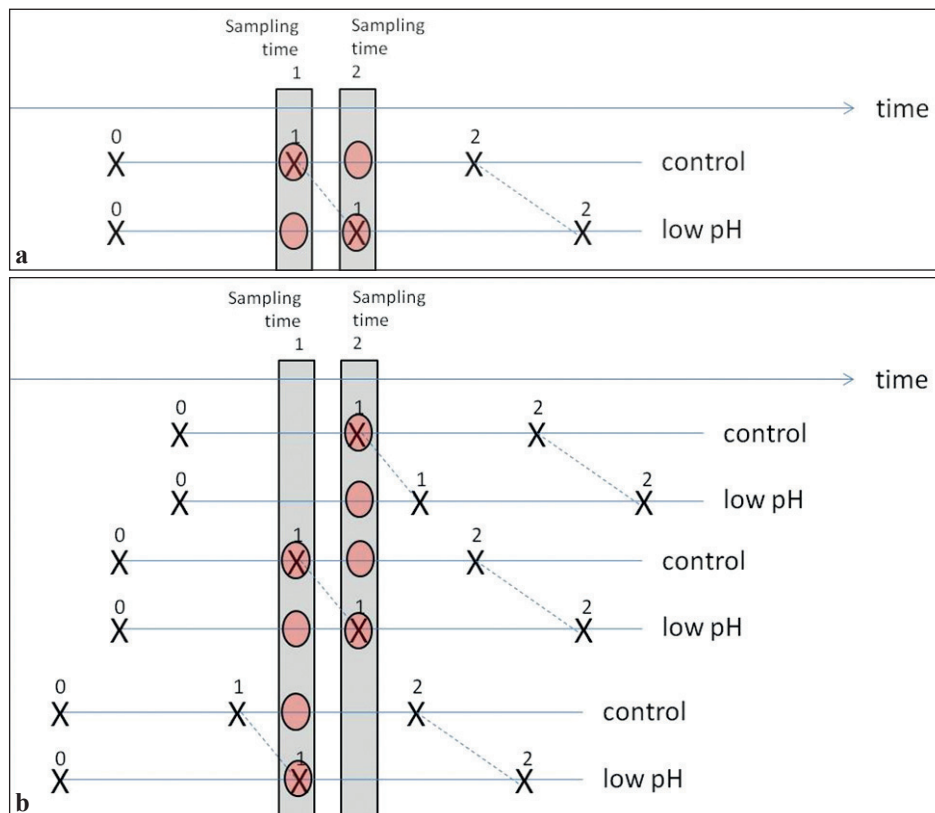

**Figure 10.4** Example of good experimental design for a microarray experiment when developmental and/or growth rates are impacted by ocean acidification. a) Simple design (4 samples at 2 sampling times) allowing the comparison of the same developmental signpost (1) and same times. b) Complex design (8 samples at 2 sampling times) allowing comparison of the same developmental signpost (1) at the same time and allow revealing impact of any other confounding factor.

For continuous or semi-continuous processes with rates influenced by the given treatment, the ideal method consists in **following the whole process** by making multiple observations over time (e.g. respiration in sea urchin larvae under different feeding regimes; Meyer *et al.*, 2007). However, this is not always possible due to practical constraints. For example, some molecular techniques such as microarrays are costly, both financially and regarding biological material needed, and, in most cases the investigator is allowed only few sampling points (see below for questions concerning the experimental design in such experiments).

There are several ways to correct for “age” and take into account the impact of the tested parameter on growth or developmental rate including (1) using a **standardised time scale** that takes confounding parameters into account (e.g. temperature × day; Thorndyke *et al.*, 2003; see Figure 10.3a), (2) the use of the **virtual age** (i.e. the time required in controlled conditions to reach a precisely defined stage based on relevant morphometry and/or signposts; see Figure 10.3b), which can be a more efficient way to correct for the age, and (3) including relevant signposts into the analysis.

As an example, we can consider a theoretical design for a microarray experiment to assess the impact of ocean acidification on larval development using the hypothesis that low pH will have a negative impact on developmental rate.

Transcription profiling using suppression subtractive hybridisation or microarrays is an important approach in ecological genomics, for example when studying CO<sub>2</sub> effects (Dupont *et al.*, 2007; Deigweier *et al.*, 2008). In this technique, RNA is isolated from two (or more) different samples derived from study subjects under

different conditions. The easiest and classic experimental design comprises exposure of organisms to two different treatments for a given time (see O'Donnell *et al.* (2009, 2010) for recent examples in the ocean acidification field).

However, in our theoretical example, pH affects developmental rate, and comparing individuals from the treatments at a given time is not relevant (see discussion above). Therefore, a more complex experimental design is needed. The easiest way to solve this problem is to include developmental signposts in the sampling. Rather than sampling at given times (sampling time 1), another sample should be taken (sampling time 2) when the larvae reach the same developmental signpost at low pH as those in the control conditions at sampling time 1 (Figure 10.4a). This design will then allow comparison of both the same time (but different developmental signposts) and the same developmental signpost (but different time), and then allow discrimination between the impact of the treatment on specific gene expression patterns from the impact on developmental rate. Ideally, to assess the impact of other potentially confounding factors, samples should also be taken at all developmental stages under the experimental pH at the same sampling times (Figure 10.4b).

### 10.3 Approaches and methodologies: metabolic studies

Performance capacity of an organism is one basic link between environmental challenges like ocean warming and acidification and ecosystem level consequences (Pörtner & Farrell, 2008). Performance capacity is closely linked to metabolic capacity. Therefore, the study of metabolic rate under various environmental conditions and during various behaviours provides a basis for addressing performance and is one of the most common physiological characters investigated. Both the capacity of performance and associated metabolic capacity may change during life history and among various larval stages. The discussion above is therefore most relevant for analyses of metabolic rate, which changes not only depending on life stage but also, within a life stage, on body size and age or under the influence of environmental parameters. This section will briefly address the principles of metabolic studies across life stages.

In animals, aerobic scope is a proxy for performance capacity. The excess in oxygen availability is reflected in an animal's aerobic scope, which supports a performance curve with an optimum close to an upper thermal limiting threshold (see below). These considerations match earlier definitions by Fry (1971) who classified environmental factors based upon their influence on aerobic metabolism and aerobic scope (the difference between the lowest and highest rates of aerobic respiration). Aerobic scope is the difference between maximum aerobic metabolic rate (displayed, for example, under maximum sustained exercise conditions) and standard metabolic rate (the rate associated with maintenance in the resting, conscious and unfed animal). Feeding, growth, behaviour and muscular exercise exploit the range of aerobic scope. Net aerobic scope is restricted to a species-specific thermal window (see below).

The study of standard metabolic rate requires excluding the effects of stress, food consumption or spontaneous activity on metabolic rate. It also requires consideration of whether an animal is an oxyregulator or an oxyconformer (Figure 10.5). It has been recognised earlier that animals may show different patterns of oxygen consumption in response to changes in ambient partial pressure of oxygen (P<sub>O<sub>2</sub></sub>). Some keep their oxygen consumption more or less constant in a wide range of P<sub>O<sub>2</sub></sub> and are called oxyregulators. Others reduce their oxygen uptake with decreasing oxygen tensions and have, consequently, been termed oxyconformers. Intermediate responses exist (Mangum & van Winkle, 1973) which do not support such clear categorisation. It is nonetheless useful to help identify metabolic patterns of oxyconformity and the underlying mitochondrial mechanisms. Circumstantial evidence for the presence of an alternative mitochondrial oxidase (cytochrome o) exists in lower marine invertebrates, for example sipunculids, annelids or bivalves (Pörtner *et al.*, 1985; Tschischka *et al.*, 2000; Buchner *et al.*, 2001). This oxidase might represent an ancient mechanism of oxygen detoxification used in animals that live in hypoxic environments. Only these aerobic oxyconformers, which display oxyconformity at cellular and mitochondrial levels should be considered as "true" oxyconformers, whereas the progressive drop

in oxygen consumption seen during extreme hypoxia in both oxyconformers and oxyregulators is caused by oxygen supply being insufficient to completely cover energy demand. Variable intracellular oxygen levels drive variable rates of oxygen consumption in oxyconformers, whereas this rate remains constant above a critical threshold (critical  $P_{O_2}$ ) in oxyregulators. The critical  $P_{O_2}$  characterises the degree of hypoxia sensitivity of a species or life stage.

The terms oxyconformity and oxyregulation have been defined for quiescent animals, which display a baseline or a “standard” metabolic rate. Standard metabolic rate (SMR) is defined as the lowest rate of oxygen consumption for oxyregulators, obtained when all organs are at rest. The data available for several oxyregulators suggest that this rate is maintained down to the critical  $P_{O_2}$  ( $P_c$ ), below which anaerobiosis starts (see below). This clear physiological definition of SMR excludes the “perturbing” effect of spontaneous muscular activity on the pattern of oxygen consumption during hypoxia. SMR is analysed by: (1) correcting for the influence of spontaneous activity during long-term measurements, (2) extrapolating to zero activity during analyses of aerobic metabolism at various activity levels, or (3) determining metabolic rate at or slightly above the  $P_c$  to exclude the effect of oxyconformity mechanisms (Figure 10.5). Standard metabolic rate is determined in the post-absorptive organism considering that food-induced changes in metabolic rate (specific dynamic action) may last between hours and weeks, depending on metabolic performance of the animal or on ambient temperature.

Ideally, SMR is determined in a flow-through system, simulating natural conditions of the animal in terms of ambient light or temperature. A constant metabolic rate is reflected in a clearly measurable steady-state drop in oxygen tensions (e.g. by around 10%, i.e. 2 kPa, or 20,000  $\mu$ atm when starting from normoxia), while a constant flow of water is maintained. It requires consideration that similar molar quantities of  $CO_2$  will accumulate in the respirometer. At 20°C and with a respiratory quotient (RQ) of 1 (carbohydrate catabolism), the about 30-fold higher solubility of  $CO_2$  in water will cause a rise in  $CO_2$  tensions 30-fold lower than the drop in oxygen tension (e.g. by around 0.066 kPa or 660  $\mu$ atm). This value is a maximum estimate under the assumption that the greatest proportion of  $CO_2$  remains fugacious and does not form  $H_2CO_3$ . At seawater pH, the rate of formation of  $CO_2$  hydrate is minimal (Pilson, 1998). This rise will then be reduced by the response of seawater buffers (see chapter 9). Net proton excretion by the organism would further increase  $CO_2$  tensions. Somewhat lower levels of  $CO_2$  accumulation result with RQs of 0.7 (lipids) or around 0.85 (proteins or mixed diets). Overall, such fluctuations are in the order of magnitude of ocean acidification scenarios and require consideration during studies of effects on metabolism and also when setting perfusion rates in experimental systems to relatively low rates.

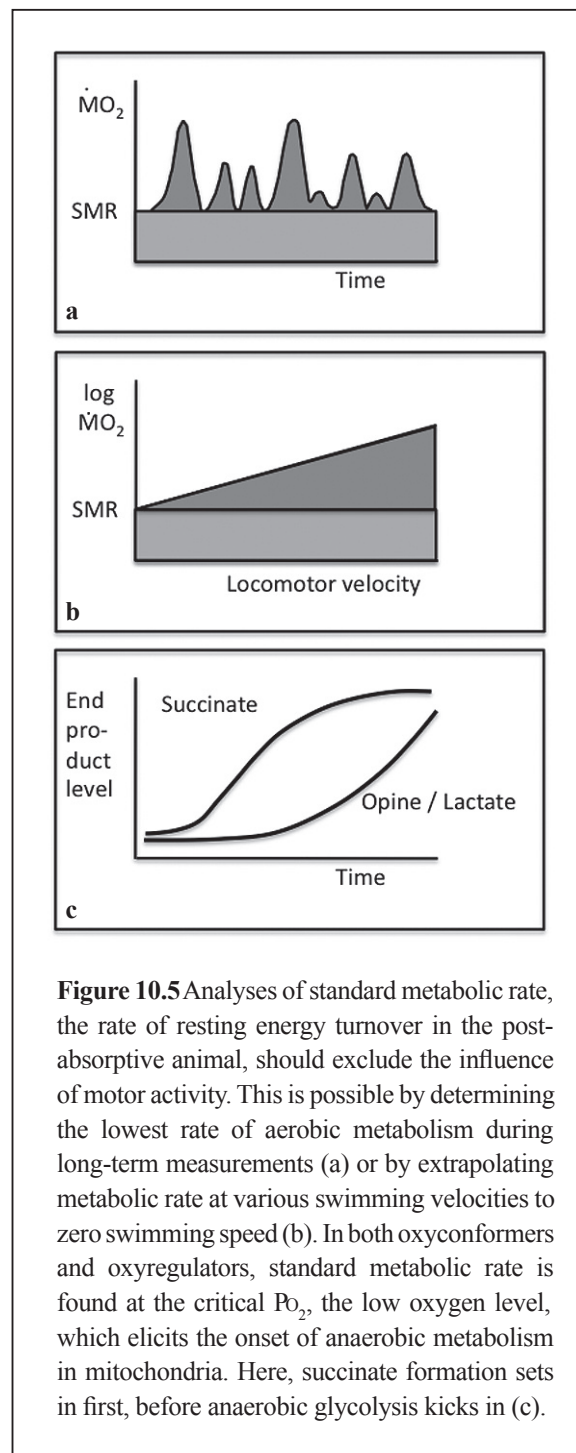

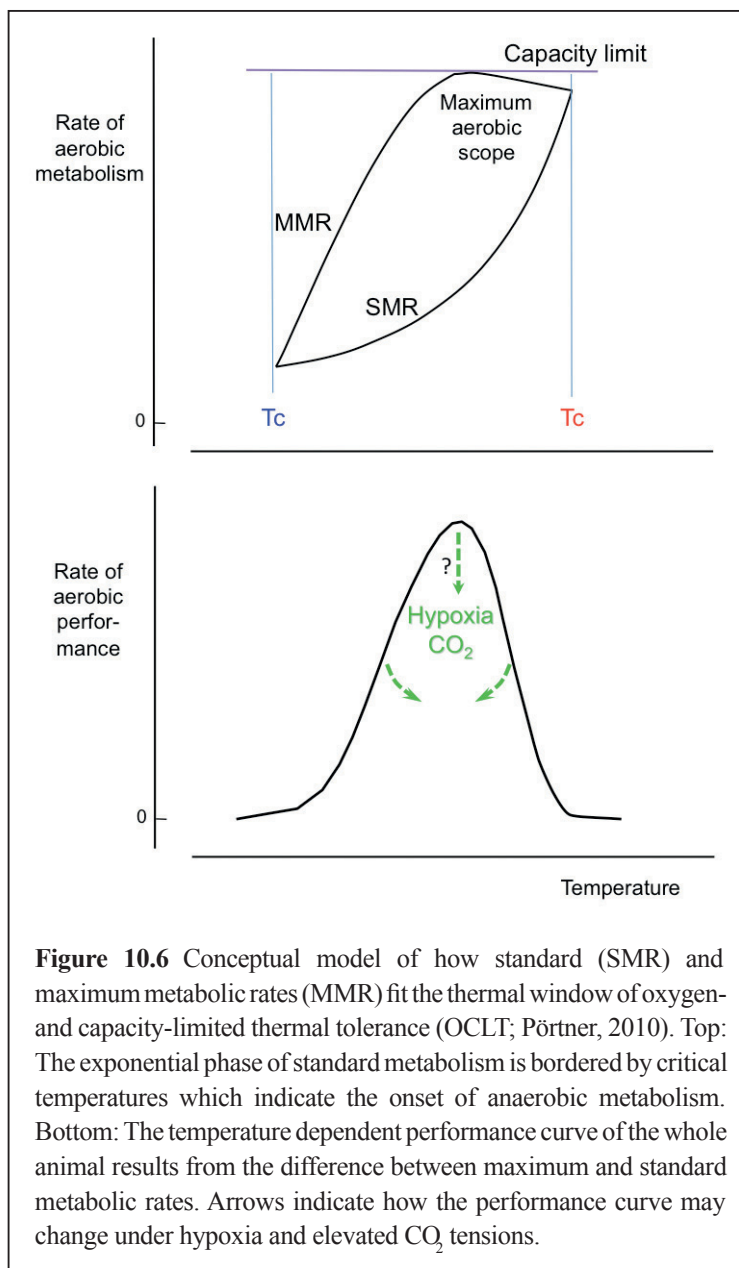

Prior to analysis, a sufficiently long acclimation period (typically around a day in temperate zone invertebrates or fish) is necessary to ensure the resting state of the organism, visible from a minimisation of steady-state metabolic rate. Before measuring, any flow-through system must reach equilibrium washout. Measurement periods usually last more than 3 h for a clear analysis of steady state metabolism. Acute changes in metabolic rate in response to changing experimental conditions (temperature, CO<sub>2</sub> additions) will have to be quantified by correcting for the washout characteristics of the system, until a new steady-state is reached. Alternatively, oxygen consumption can be derived from the oxygen depletion in closed systems. Here, stoichiometric CO<sub>2</sub> accumulation also occurs, as outlined above, but not to a steady-state level. Sufficient flushing between measurements should make sure that oxygen depletion and CO<sub>2</sub> accumulation always start from normoxic and normocapnic levels (380 ppm), respectively. Long-term analyses can still be carried out in an intermittent flow system, which is flushed and replenished with oxygenated water and then closed for recordings of oxygen depletion at regular intervals.

SMR displays an exponential phase between critical temperatures (Figure 10.6). Aerobic scope is limited to this range of temperatures,

and thereby defines a species-specific temperature window, which forms the basis for the temperature dependent biogeography of a species. A functional optimum characterises the thermal optimum. Building on the concept of oxygen- and capacity-limited thermal tolerance (OCLT), experiments should identify this range, both acutely, to identify the sensitivity of animals to short-term temperature fluctuations within a specific season, and after long-term acclimation to a (seasonal) change in temperature, which allows animals to shift their thermal window as between seasons (Wittmann *et al.*, 2008). This enables addressing the specific effects of other factors, like ocean acidification, over a relevant range of environmental temperatures (cf. Pörtner, 2010) and, thereby, identify more comprehensively which factors are causing functional limitations, alone or in combination.

As outlined above, not only SMR, but also and independently, aerobic scope and thus aerobic exercise capacity might be affected by ocean acidification. The study of metabolism can be carried out during periods of sustained activity in animals on treadmills or in swim tunnels, for example in the case of fish or squid. Aerobic exercise capacity needs to be clearly distinguished from exercise bouts supported by anaerobic metabolism, such as during attack or escape responses. For a complete understanding, the mechanistic background of metabolic and functional scopes for performance requires exploration.



Technology and approaches for studying aerobic exercise metabolism are most advanced in the field of fish physiology (see e.g. Hammer (1995) and Plaut (2001) for comprehensive reviews), whereas only a few attempts have been made to study oxygen consumption during aerobic exercise in invertebrates (e.g. Booth *et al.*, 1984 (decapod crustacea); Wells *et al.*, 1983, 1988 (cephalopoda)). In order to study aerobic scope for exercise, fish or cephalopods are forced to swim against a current in a sealed chamber of a swim tunnel respirometer. Oxygen consumption rates are then calculated from linear declines in oxygen partial pressure within the chamber (no more than 1-2 kPa), which is measured using an oxygen electrode or optode (see below). Swimming speed is increased in a stepwise mode and the water in the otherwise sealed chamber is replaced between oxygen consumption measurement runs in order to maintain high oxygen partial pressures (typically >18 kPa) at all times (= intermittent closed respirometry). Typically, fish are maintained at a given swimming velocity for 5 to 60 minutes (e.g. Plaut, 2001). Once the fish cannot swim against the current at high velocities for this entire preset time period, the critical swimming speed ( $U_{crit}$ ) is reached. It can be calculated according to Brett (1964):

$$U_{crit} = u_i + \left( \frac{t_i}{t_{ii}} u_{ii} \right); \quad (10.1)$$

with  $u_i$  being the highest swimming velocity ( $\text{m s}^{-1}$ ) sustained for the entire preset time interval  $t_i$ ,  $t_i$  the time interval shorter than  $t_{ii}$ , spent at exhausting velocity (min),  $t_{ii}$  the time interval at each swimming speed (min) and  $u_{ii}$  the velocity increment between steps ( $\text{m s}^{-1}$ ). Oxygen consumption values  $\text{M}\dot{\text{O}}_2$  can then be plotted against swimming speed. Active metabolic rate (AMR) can be approximated as the metabolic rate at the highest sustainable swimming speed. Standard metabolic rate (SMR) can be estimated from  $\text{M}\dot{\text{O}}_2$  vs. swimming velocity relationships by extrapolating to zero swimming speed (cf. Reidy *et al.*, 2000). Previous studies have established that  $U_{crit}$  and  $\text{M}\dot{\text{O}}_2$  during  $U_{crit}$  trials are significantly reproducible traits for individual fish (e.g. Nelson *et al.*, 1994; Reidy *et al.*, 2000). Aerobic scope (AS) can be estimated by subtracting SMR from AMR. Automated swim tunnel respirometers can be purchased in various sizes from a few selected companies (e.g. Loligo Systems ApS, Denmark; Qubit Systems, Canada).

#### 10.4 Study of early life stages

Most studies of metabolism focus on juveniles and young adults, since these are sufficiently large and easy to maintain in the laboratory. However, one crucial field of future study comprises larval responses to ocean acidification. In the marine realm, most ectothermal animals pass through complex life cycles comprising planktonic larval phases, which might be among the most sensitive to expected scenarios (Pörtner & Farrell, 2008) despite the presence of mechanisms that can improve overall resistance to stressful ambient conditions (Hamdoun & Epel, 2007). Metabolic measurements will help to unravel effects of ocean acidification on larvae and larval development. Larval respiration rates represent a comprehensive parameter to characterise metabolic rates. Metabolic processes underneath comprise carbohydrate, lipid and protein metabolism. There is a huge amount of literature on changes in the biochemical composition of early life stages and how to measure them. Covering these methods is beyond the scope of this chapter.

Determining metabolic rates of larval invertebrates and fish involves a number of technical difficulties because such larval stages are small, they are usually swimming actively in the water column and they are developing (section 10.6). All of these factors influence respiration rates. Furthermore, non-feeding and feeding stages have to be distinguished during the early life history of a species as these display strong differences in respiration rates (Marsh & Manahan, 1999; Anger, 2001; Meyer *et al.*, 2007). Animals may have either non-feeding larvae (lecithotrophic) or feeding (planktotrophic) larvae. For the planktotrophic ones, the onset of feeding will cause a strong rise in respiration rates. The respiration rate associated with feeding has been termed specific dynamic action, SDA (e.g. Kiørboe *et al.*, 1987).

One problem during the actual measurement centres on the need to confine a small pelagic organism to a small volume as needed for oxygen depletion measurements. Minimising handling stress and controlling tiny sizes and locomotor activity are the biggest challenges (Childress, 1977) to ensure accurate measurements of metabolic rates in marine invertebrate and fish embryos and larvae (for an extensive discussion see Hoegh-Guldberg &

Pearse (1995), Marsh & Manahan (1999), Marsh *et al.* (2001), Glazer *et al.* (2004) and Storch *et al.* (2009)). Depending on the sensitivity and stability of the oxygen sensors, tiny individuals may need to be pooled for a single measurement, leading to crowding and potential stress effects. The optode (Marsh *et al.*, 2001; Thatje *et al.*, 2003; Szela & Marsh, 2005; Storch *et al.*, 2009a) and the coulometer (Marsh & Manahan, 1999; Peck & Prothero-Thomas, 2002) most conveniently measure individual respiration rates in embryonic and larval life stages of marine invertebrates beyond a minimal size. In others, however, the sensitivity of the technique chosen needs to be maximised by appropriate adjustments in experimental design. For instance, in sea urchins, one may need several hundreds of larvae to obtain a sufficient signal when using classical optodes. Alternatively, one may convert a 384-well microtiter plate into a 384-chamber (50 $\mu$ l) micro-respirometer using a plate-reading fluorometer for continuous, real-time data acquisition (Szela & Marsh, 2005; Strathmann *et al.*, 2006).

In their natural habitat, larvae swim permanently in the water column and measurements, therefore, include the effect of motor activity and yield routine metabolic rates. The costs for locomotor activity can result in more than threefold higher oxygen consumption rates, seen, for example, in megalopae of the kelp crab *Taliepus dentatus* (Storch *et al.*, 2009b). Activity costs of crustacean larvae can be quantified from pleopod beat rates. SMR can then be calculated by subtracting these costs from measured rates. Respiratory costs of swimming in fish larvae can be calculated from the relationship between swimming speeds and respiration rates (Kaufmann, 1990). Larval maintenance, swimming and metamorphosis all use energy from a common pool, such that increased allocation to maintenance or swimming occurs at the expense of growth and/or development (Hunter *et al.*, 1999; Marshall *et al.*, 2003). Ocean acidification might affect each of these processes differently, such that the organismal energy budget needs to be analysed (Storch *et al.*, 2009a).

### 10.5 Techniques for oxygen analyses

The most common techniques of measuring oxygen are (1) Winkler titration (Winkler, 1888; Meyer, 1935), (2) polarographic oxygen sensors or Clark-type electrodes (after Clark (1956), see also Gnaiger & Forstner (1983)), (3) coulometric oxygen sensors (Peck & Whitehouse, 1992; Hoegh-Guldberg & Manahan, 1995) and (4) optical oxygen sensors (optrodes or optodes) (Stokes & Somero, 1999; Frederich & Pörtner, 2000; Marsh *et al.*, 2001; Gatti *et al.*, 2002; Glazer *et al.*, 2004; Lannig *et al.*, 2004; Szela & Marsh, 2005), e.g. O<sub>2</sub> PST1, Presens. Temperature needs to be finely controlled as metabolic rate varies with temperature. Adequate mixing of the chamber volume ensures precise recordings and elimination of boundary layer effects. For convenience, metabolic rate should be given in molar units of oxygen consumption per unit of metabolically active (soft) body or tissue weight, for clear access to stoichiometries and the effective concentrations of substrates and other biochemical components.

1. The Winkler titration and its modifications are often denoted the “gold standard” for measuring dissolved oxygen. More recent methods are usually validated by comparing their results with those of the Winkler technique (Wilkin *et al.*, 2001; Glazer *et al.*, 2004). However, the Winkler titration is laborious and is not suitable for continuous non-invasive monitoring of oxygen concentrations. Further disadvantages of Winkler titrations include the use of toxic chemicals (e.g. sodium azide) for some modifications and the requirement of tedious wet chemistry techniques with multiple steps. Large sample volumes are needed, and handling and transport of the apparatus can be cumbersome.
2. Clark-type electrodes have been widely and reliably used in flow-through or closed system analyses of respiration. Measurements need to be corrected for the inherent rate of oxygen consumption by the electrodes. Furthermore, they are susceptible to disturbance of the signal when stirring.
3. Most coulometric oxygen sensors are based on redox indicators and are pH sensitive, which has to be considered when measuring in seawater with varying CO<sub>2</sub> concentrations and, thus, pH values.
4. Optical oxygen sensors (optrodes or optodes) depend on dynamic quenching of an oxygen-sensitive fluorophore. These sensors do not consume oxygen, have predictable temperature responses, have fast response times and long-term stability, and can be made inert to interfering chemicals like acids. The decay of the fluorophore over time requires repeated calibration and causes sensitivity losses.

## 10.6 Overall suggestions for improvements

Potential pitfalls in experimental design and metabolic studies include the following:

- The age of the individual or the time periods chosen for exposure may not be relevant for comparative –omic or physiological studies when growth or developmental rates are affected by ocean acidification and change the relative time scale of crucial processes.
- The metabolic rate measured may not fully reflect resting, routine or active states of the organism as defined by the experimenter. Stress phenomena or feeding effects may persist longer than anticipated before the organism displays standard metabolic rate or clearly defined parameters such as active metabolic rate, net or factorial aerobic scopes.

Suggestions to alleviate these problems include the following:

- Methods and frame of reference (preferably according to developmental signposts) should be clearly defined.
- Methods should be used that allow work at the level of the individual in order to assess the variability in the population.
- The physiological or acclimation state of the organism should be clearly definable, as demonstrated by stable characters, for example based on long-term recording of oxygen consumption.

## 10.7 Data reporting

Investigators should report:

- Information required to fully describe the experimental procedure and exposure regime, length of exposure, water physicochemistry values (levels of e.g. pH, bicarbonate, carbonate, calcium) on physiologically relevant scales.
- Information required to fully describe the physiological state of the animals (e.g. acclimation and treatment), and their age (post-fertilisation) and life or developmental stage (preferably according to developmental signposts).

## 10.8 Recommendations for standards and guidelines

1. When pH is affecting the rate of any investigated process, the experimental design should be adapted to discriminate the real impact on the parameter from other confounding factors linked to differential growth or development. Specifically, comparative studies on developmental stages should comprise experiments monitoring changes progressively over time to clearly distinguish the effects of developmental delay from those of the stressor itself at certain time points of ontogeny.
2. Metabolic rate studies should make sure to use gas-tight material for chambers and tubings.
3. Metabolic rate analyses should allow the animal to reach a steady-state rate of oxygen consumption clearly defined for its physiological situation. Experimental animals should be unrestrained and allowed to resume unstressed resting rates before starting any trials.
4. Upon changes in metabolic rate in flow-through systems, consider the washout characteristics of your system before attributing a reading to a specific experimental condition.
5. Intermittent flow systems should be fully washed out between measurement periods in order to minimise the interference and accumulation of respiratory CO<sub>2</sub>.
6. Periods and levels of spontaneous activity levels (steady-state and non steady-state) should be recorded and associated increments in metabolic costs determined.

### 10.9 References

- Anger K., 2001. The biology of decapod crustacean larvae. *Crustacean Issues* 14:1-420.
- Booth C. E., McMahon B. R., DeFur P. L. & Wilkes P. R. H., 1984. Acid-base regulation during exercise and recovery in the blue crab, *Callinectes sapidus*. *Respiration Physiology* 58:359-376.
- Brett J. R., 1964. The respiratory metabolism and swimming performance of young sockeye salmon. *Journal of the Fisheries Research Board of Canada* 21:1183-1226.
- Buchner T., Abele D. & Pörtner H.-O., 2001. Oxyconformity in the intertidal worm *Sipunculus nudus*: the mitochondrial background and energetic consequences. *Comparative Biochemistry and Physiology B* 129:109-120.
- Calcagno J. A., Thatje S., Anger K., Lovrich G. A. & Kaffenberger A., 2003. Changes in biomass and chemical composition during lecithotrophic larval development of the southern stone crab *Paralomis granulosa*. *Marine Ecology Progress Series* 257:189-196.
- Cañestro C., Bassham S. & Postlethwait J., 2005. Development of the central nervous system in the larvacean *Oikopleura dioica* and the evolution of the chordate brain. *Developmental Biology* 285:298-315.
- Childress J. J., 1977. Physiological approaches to the biology of midwater crustaceans. In: Andersen N. R. & Zahuranec B. J. (Eds.), *Oceanic sound scattering prediction*, pp. 301–324. New York: Plenum Press.
- Clark L. C., 1956. Monitor and control of blood and tissue oxygen tensions. *Transactions of the American Society for Artificial Internal Organs* 2:41-48.
- Deigweiher K., Koschnick N., Pörtner H.-O. & Lucassen M., 2008. Acclimation of ion regulatory capacities in gills of marine fish under environmental hypercapnia. *American Journal of Physiology* 295:R1660-R1670.
- Dupont S., Ortega-Martínez O. & Thorndyke M., 2010. Impact of near-future ocean acidification on echinoderms. *Ecotoxicology* 19:449-462.
- Dupont S. & Thorndyke M. C., 2006. Growth or differentiation? Adaptive regeneration in the brittlestar *Amphiura filiformis*. *Journal of Experimental Biology* 209:3873-3881.
- Dupont S. & Thorndyke M. C., 2008. Ocean acidification and its impact on the early life-history stages of marine animals. In: Briand F. (Ed.), *Impacts of acidification on biological, chemical and physical systems in the Mediterranean and Black Seas*, pp. 89-97. Monaco: CIESM.
- Dupont S., Wilson K., Obst M., Sköld H., Nakano H. & Thorndyke M. C., 2007. Marine ecological genomics: when genomics meets marine ecology. *Marine Ecology Progress Series* 332:257-273.
- Frederich M. & Pörtner H.-O., 2000. Oxygen limitation of thermal tolerance defined by cardiac and ventilatory performance in spider crab, *Maja squinado*. *American Journal of Physiology* 279:R1531-R1538.
- Fry F. E. J., 1971. The effect of environmental factors on animal activity. In: Hoar W. S. & Randall D. J. (Eds.), *Fish Physiology, Vol. 6*, pp. 1–98. New York: Academic Press.
- Gatti S., Brey T., Müller W. E. G., Heilmayer O. & Holst G., 2002. Oxygen microoptodes: a new tool for oxygen measurements in aquatic animal ecology. *Marine Biology* 140:1075-1085.
- Glazer B. T., Marsh A. G., Stierhoff K. & Luther G. W., 2004. The dynamic response of optical oxygen sensors and voltammetric electrodes to temporal changes in dissolved oxygen concentrations. *Analytica Chimica Acta* 518:93-100.
- Gnaiger E. & Forstner H., 1982. *Polarographic oxygen sensors. Aquatic and physiological applications*. 390 p. Berlin: Springer-Verlag.
- Gooding R. A., Harley C. D. G. & Tang E., 2009. Elevated water temperature and carbon dioxide concentration increase the growth of a keystone echinoderm. *Proceedings of the National Academy of Science U.S.A.* 106:9316-9321.
- Hamdoun A. & Epel D., 2007. Embryo stability and vulnerability in an always changing world. *Proceedings of the National Academy of Sciences U.S.A.* 104:1745-1750.
- Hammer C., 1995. Fatigue and exercise tests with fish. *Comparative Biochemistry and Physiology A* 112:1-20.

- Hoegh-Guldberg O. & Manahan D., 1995. Coulometric measurement of oxygen consumption during development of marine invertebrate embryos and larvae. *Journal of Experimental Biology* 198:19-30.
- Hoegh-Guldberg O. & Pearse J. S., 1995. Temperature, food availability, and the development of marine invertebrate larvae. *American Zoologist* 35:415-425.
- Hunter E., Shimizu K. & Fusetani N., 1999. Role of protein in larval swimming and metamorphosis of *Bugula neritina* (Bryozoa : Cheilostomatida). *Marine Biology* 133:701-707.
- Kaufmann R., 1990. Respiratory cost of swimming in larval and juvenile cyprinids. *Journal of Experimental Biology* 150:343-366.
- Kjørboe T., Munk P. & Richardson K., 1987. Respiration and growth of larval herring *Clupea harengus*: relation between specific dynamic action and growth efficiency. *Marine Ecology Progress Series* 40:1-10.
- Lannig G., Bock C., Sartoris F. J. & Pörtner H.-O., 2004. Oxygen limitation of thermal tolerance in cod, *Gadus morhua* L., studied by magnetic resonance imaging and on-line venous oxygen monitoring. *American Journal of Physiology* 287:R902-R910.
- Leandro S. M., Queiroga H., Rodriguez-Graña L. & Tiselius P., 2006. Temperature-dependent development and somatic growth in two allopatric populations of *Acartia clausi* (Copepoda : Calanoida). *Marine Ecology Progress Series* 322:189-197.
- Mangum C. & Van Winkle W., 1973. Responses of aquatic invertebrates to declining oxygen conditions. *American Zoologist* 13:529-541.
- Marsh A. G., Cohen S. & Epifanio C. E., 2001. Larval energy metabolism and physiological variability in the Asian shore crab *Hemigrapsus sanguineus*. *Marine Ecology Progress Series* 218:303-309.
- Marsh A. G. & Manahan D. T., 1999. A method for accurate measurements of the respiration rates of marine invertebrate embryos and larvae. *Marine Ecology Progress Series* 184:1-10.
- Marshall D. J., Pechenik J. A. & Keough M. J., 2003. Larval activity levels and delayed metamorphosis affect post-larval performance in the colonial, ascidian *Diplosoma listerianum*. *Marine Ecology Progress Series* 246:153-162.
- Meyer E., Green A. J., Moore M. & Manahan D. T., 2007. Food availability and physiological state of sea urchin larvae (*Strongylocentrotus purpuratus*). *Marine Biology* 152:179-191.
- Meyer H., 1935. Die Atmung von *Asterias rubens* und ihre Abhängigkeit von verschiedenen Außenfaktoren. *Zoologische Jahrbuecher Abteilung fuer Allgemeine Zoologie und Physiologie der Tiere* 55:349-398.
- Nelson J. A., Tang Y. & Boutilier R. G., 1994. Differences in exercise physiology between two Atlantic Cod (*Gadus morhua*) populations from different environments. *Physiological Zoology* 67:330-354.
- O'Donnell M. J., Hammond L. M. & Hofmann G. E., 2009. Predicted impact of ocean acidification on a marine invertebrate: elevated CO<sub>2</sub> alters response to thermal stress in sea urchin larvae. *Marine Biology* 156:439-446.
- O'Donnell M. J., Todgham A. E., Sewell M. A., Hammond L. M., Ruggiero K., Fangué N. A., Zippay M. L. & Hofmann G. E., 2010. Ocean acidification alters skeletogenesis and gene expression in larval sea urchins. *Marine Ecology Progress Series* 398:157-171.
- Peck L. S. & Prothero-Thomas E., 2002. Temperature effects on the metabolism of larvae of the Antarctic starfish *Odontaster validus*, using a novel micro-respirometry method. *Marine Biology* 141:271-276.
- Peck L. S. & Whitehouse M. J., 1992. An improved desorber design for use in coulometry. *Journal of Experimental Marine Biology and Ecology* 163:163-167.
- Pilson M. E. Q., 1998. *An introduction to the chemistry of the sea*. 431 p. New Jersey: Prentice-Hall.
- Plaut I., 2001. Critical swimming speed: its ecological relevance. *Comparative Biochemistry and Physiology A* 131:41-50.
- Pörtner H.-O., 1989. The importance of metabolism in acid base regulation and acid base methodology. *Canadian Journal of Zoology* 67:3005-3017.
- Pörtner H.-O., 2010. Oxygen- and capacity-limitation of thermal tolerance: a matrix for integrating climate-related stressor effects in marine ecosystems. *Journal of Experimental Biology* 213:881-893.
- Pörtner H.-O. & Farrell A. P., 2008. ECOLOGY: Physiology and climate change. *Science* 322:690-692.

- Pörtner H.-O., Heisler N. & Grieshaber M. K., 1985. Oxygen consumption and modes of energy production in the intertidal worm *Sipunculus nudus* L: definition and characterization of the critical PO<sub>2</sub> for an oxyconformer. *Respiration Physiology* 59:361-377.
- Qiu J. W. & Qian P. Y., 1997. Effects of food availability, larval source and culture method on larval development of *Balanus amphitrite* amphitrite Darwin: implications for experimental design. *Journal of Experimental Marine Biology and Ecology* 217:47-61.
- Reidy S. P., Kerr S. R. & Nelson J. A., 2000. Aerobic and anaerobic swimming performance of individual Atlantic cod. *Journal of Experimental Biology* 203:347-357.
- Shirayama Y. & Thornton H., 2005. Effect of increased atmospheric CO<sub>2</sub> on shallow water marine benthos. *Journal of Geophysical Research- Oceans* 110, C09S08. doi:10.1029/2004JC002618.
- Stokes M. D. & Somero G. N., 1999. An optical oxygen sensor and reaction vessel for high-pressure applications. *Limnology and Oceanography* 44:189-195.
- Storch D., Santelices P., Barria J., Cabeza K., Pörtner H.-O. & Fernández M., 2009a. Thermal tolerance of crustacean larvae (zoea I) in two different populations of the kelp crab *Taliepus dentatus* (Milne-Edwards). *Journal of Experimental Biology* 212:1371-1376.
- Storch D., Fernández M., Pörtner H.-O. & Navarrete S. A., 2009b. Thermal tolerance of various larval stages of the kelp crab *Taliepus dentatus*. *Comparative Biochemistry and Physiology A* 153:S58.
- Strathmann R. R., Kendall L. R. & Marsh A. G., 2006. Embryonic and larval development of a cold adapted Antarctic ascidian. *Polar Biology* 29:495-501.
- Szela T. L. & Marsh A. G., 2005. Microtiter plate, optode respirometry, and inter-individual variance in metabolic rates among nauplii of *Artemia* sp. *Marine Ecology Progress Series* 296:281-289.
- Thatje S., Calcagno J. A., Lovrich G. A., Sartoris F. J. & Anger K., 2003. Extended hatching periods in the subantarctic lithodid crabs *Lithodes santolla* and *Paralomis granulosa* (Crustacea : Decapoda : Lithodidae). *Helgoland Marine Research* 57:110-113.
- Thatje S., Lovrich G. A., Torres G., Hagen W. & Anger K., 2004. Changes in biomass, lipid, fatty acid and elemental composition during the abbreviated larval development of the subantarctic shrimp *Campylonotus vagans*. *Journal of Experimental Marine Biology and Ecology* 301:159-174.
- Thorndyke M., Patruno M., Dewael Y., Dupont S. & Mallefet J., 2003. Regeneration in the ophiuroid *Amphiura filiformis*: cell biology, physiology and luminescence. In: Féral J. P. & David B. (Eds.), *Echinoderm Research 2001*, pp. 193-200. Lisse: Balkema.
- Troedsson C., Ganot P., Bouquet J.-M., Aksnes D. L. & Thompson E. M., 2007. Endostyle cell recruitment as a frame of reference for development and growth in the urochordate *Oikopleura dioica*. *Biological Bulletin* 213:325-334.
- Tschischka K., Abele D. & Pörtner H.-O., 2000. Mitochondrial oxyconformity and cold adaptation in the polychaete *Nereis pelagica* and the bivalve *Arctica islandica* from the Baltic and White Seas. *Journal of Experimental Biology* 203:3355-3368.
- Wells M. J., Hanlon R. T., Lee P. G. & DiMarco F. P., 1988. Respiratory and cardiac performance in *Lolliguncula brevis* (Cephalopoda, myopsida): the effects of activity, temperature and hypoxia. *Journal of Experimental Biology* 138:17-36.
- Wells M. J., O'Dor R. K., Mangold K. & Wells J., 1983. Oxygen-consumption in movement by Octopus. *Marine Behaviour & Physiology* 9:289-303.
- Wilkin R. T., McNeil M. S., Adair C. J. & Wilson J. T., 2001. Field measurement of dissolved oxygen: a comparison of methods. *Ground Water Monitoring and Remediation* 21:124-132.
- Winkler L. W., 1888. Die Bestimmung des in Wasser Gelösten Sauerstoffes. *Berichte der Deutschen Chemischen Gesellschaft* 21:2843-2855.
- Wittmann A. C., Schröer M., Bock C., Steeger H. U., Paul R. J. & Pörtner H.-O., 2008. Indicators of oxygen- and capacity-limited thermal tolerance in the lugworm *Arenicola marina*. *Climate Research* 37:227-240.
- Wood H. L., Spicer J. I. & Widdicombe S., 2008. Ocean acidification may increase calcification rates, but at a cost. *Proceedings of the Royal Society B: Biological Sciences* 275:1767-1773.

## 11 Production and export of organic matter

Anja Engel<sup>1</sup>, Joana Barcelos e Ramos<sup>2</sup>, Richard Geider<sup>3</sup>, David A. Hutchins<sup>4</sup>, Cindy Lee<sup>5</sup>, Björn Rost<sup>1</sup>, Rüdiger Röttgers<sup>6</sup> and Frede Thingstad<sup>7</sup>

<sup>1</sup>Alfred Wegener Institute for Polar and Marine Research, Germany

<sup>2</sup>University of the Azores, Portugal

<sup>3</sup>Department of Biological Sciences, University of Essex, UK

<sup>4</sup>Department of Biological Sciences, University of Southern California, USA

<sup>5</sup>School of Marine and Atmospheric Sciences, Stony Brook University, USA

<sup>6</sup>Institute for Coastal Research, GKSS Research Center Geesthacht, Germany

<sup>7</sup>Department of Biology, University of Bergen, Norway

### 11.1 Introduction

The ocean is one of the largest reservoirs of CO<sub>2</sub> on Earth, and one of the largest sinks for anthropogenic emissions (Sabine *et al.*, 2004). The ocean's capacity for CO<sub>2</sub> storage is strongly affected by biological processes (Raven & Falkowski, 1999). Organic matter production and export processes in the ocean drive CO<sub>2</sub> sequestration and therefore feed back to atmospheric CO<sub>2</sub> and global climate. The magnitude of CO<sub>2</sub> that is fixed each year by biological processes and exported from the surface ocean is estimated to be ~10 GTC (Boyd & Trull, 2007), and therefore about the same magnitude as the total amount of CO<sub>2</sub> released each year by anthropogenic activities. Thus, changes in export processes could, in principle, have a major influence on atmospheric CO<sub>2</sub> concentrations.

Until recently, direct effects of anthropogenic CO<sub>2</sub> on export processes in the ocean have largely been neglected (e.g. Broecker, 1991). It is therefore not surprising that we still find very few studies dealing with direct effects of elevated CO<sub>2</sub> and the related seawater acidification on biologically-mediated carbon export. Biologically driven export of organic matter in the ocean, the “biological pump” (Volk & Hoffert, 1985), is a very complex issue (Boyd & Trull, 2007, Figure 11.1). Instead of one process potentially sensitive to ocean acidification, we are dealing with a multitude of processes, such as photosynthesis, biological nitrogen fixation, microbial degradation and

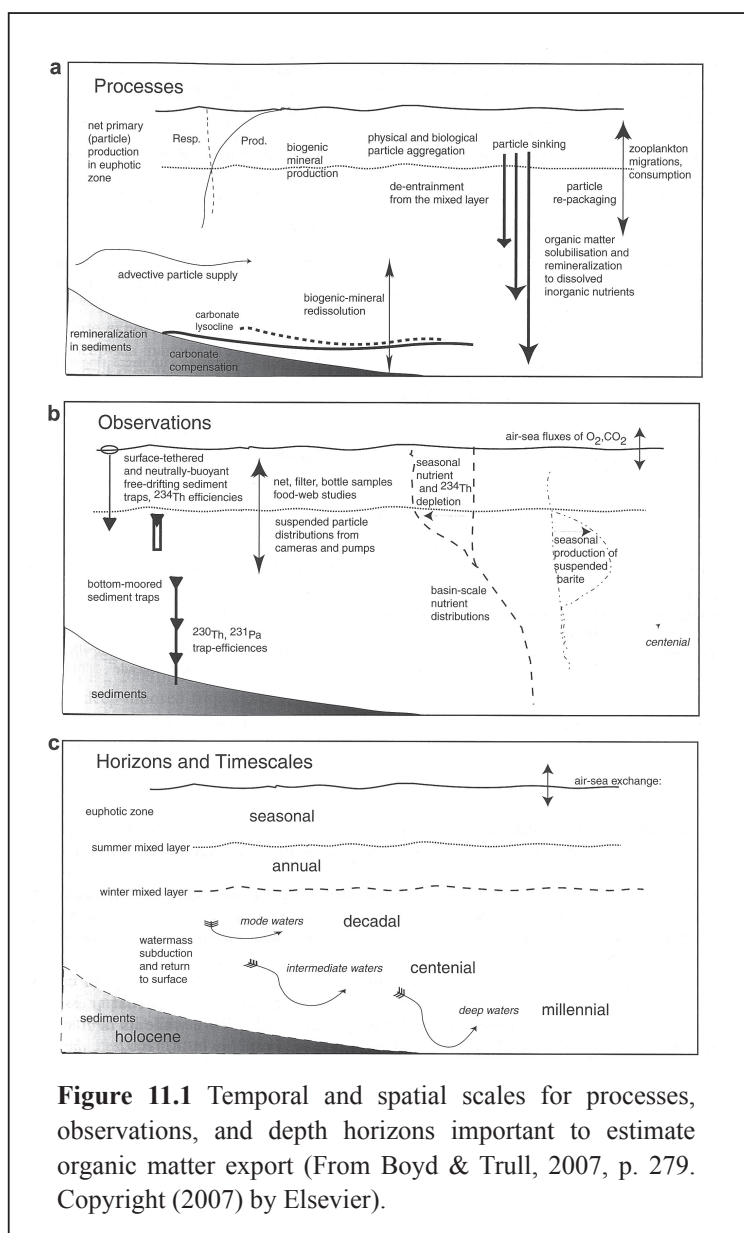

**Figure 11.1** Temporal and spatial scales for processes, observations, and depth horizons important to estimate organic matter export (From Boyd & Trull, 2007, p. 279. Copyright (2007) by Elsevier).

secondary production, as well as with different modes of transport, for example particle sinking, physical mixing of dissolved and particulate compounds and vertical migration of plankton. Moreover, these processes operate on very different temporal and spatial scales, ranging from seasonal export of biogenic production from the surface ocean to its final deposition at the deep seafloor, where carbon is stored for hundreds of thousands of years. In between lies a water column that ranges from hundreds to thousands of meters, where heterotrophic processes determine the rate of organic matter remineralisation, and therefore the efficiency of export. These long temporal and large spatial scales are enormously challenging for oceanographic research.

Methodological limitations especially apply to experimental approaches in ocean acidification research. Here, CO<sub>2</sub> or pH perturbations of the present-day situation are usually restricted to the scale and duration of an experiment. Nevertheless, potential sensitivities of organic matter and export production to seawater acidification gather scientific and political attention due to their high potential to affect ecosystem functioning, biogeochemical cycles and global climate. This chapter will provide technical guidelines for the investigation of key processes of the biological carbon pump. Due to the complex nature and the very large variety of potential methods to be applied, only some of the most important aspects can be discussed. Nevertheless, we hope that these will be useful for considering organic and export production in ocean acidification research.

### 11.2 Approaches and methodologies

#### 11.2.1 Primary production

Primary production in the sunlit ocean, i.e. the production of organic material from CO<sub>2</sub> and inorganic nutrients, is driven by photosynthesis. As this key process drives important elemental cycles and provides the energy for higher trophic levels, photoautotrophs like phytoplankton and cyanobacteria have been in the centre of ocean acidification research. An understanding of the sensitivity of photosynthesis to elevated CO<sub>2</sub> is also important when assessing other downstream processes like calcification or N<sub>2</sub> fixation as they depend on the energy supply from photosynthesis.

Photosynthesis involves a series of reactions that start with capturing light energy, converting it into ATP and NADPH, and using these compounds to fix CO<sub>2</sub> in the Calvin-Benson cycle. Several studies have focused on the process of CO<sub>2</sub> assimilation, which is inherently CO<sub>2</sub> sensitive due to the low CO<sub>2</sub> affinities of the primary carboxylating enzyme RuBisCO (Badger *et al.*, 1998). The effect of seawater carbonate chemistry on photosynthesis, however, depends strongly on the presence and characteristics of cellular CO<sub>2</sub>-concentrating mechanisms (CCMs; Giordano *et al.*, 2005). In order to measure the effect of environmental factors on photosynthesis, including ocean acidification, several different methods have been developed and applied (see also Joint Global Ocean Flux Study reports 27 and 36 at [http://ijgofs.whoi.edu/Publications/Report\\_Series](http://ijgofs.whoi.edu/Publications/Report_Series)).

As photosynthesis involves O<sub>2</sub> evolution as well as CO<sub>2</sub> fixation, photosynthetic rates can be inferred by monitoring the changes in concentrations of these gases over time, either continuously or by analysing discrete samples. Rates of O<sub>2</sub> evolution can be determined by real-time measurements using O<sub>2</sub> electrodes, O<sub>2</sub> optodes, and membrane-inlet mass spectrometry (MIMS). These approaches have been intensively used in laboratory experiments (e.g. Beardall, 1991; Nielsen, 1995; Trimborn *et al.*, 2008). Calibrations are achieved by measuring signals from known concentrations of O<sub>2</sub>, commonly O<sub>2</sub>-free and air-saturated (21% O<sub>2</sub>), and therefore these three approaches yield similar results for photosynthetic O<sub>2</sub> evolution (as well as respiration). Rates of net O<sub>2</sub> evolution and/or CO<sub>2</sub> fixation can also be inferred by looking at the O<sub>2</sub> evolution or DIC drawdown in gas-tight bottles over time. O<sub>2</sub> concentrations are determined by Winkler titration (Winkler, 1888), and changes in DIC concentrations are measured for instance by a DIC analyser (Stoll *et al.*, 2001). Since rates are derived from two measurements (before and end of incubation), it is important to choose meaningful time intervals. The latter approach is mostly used in field studies with incubation times in the order of hours to one day. It is possible to correct for respiration by using darkened bottles. This approach is often combined with <sup>14</sup>C-DIC incubations (see below).



Another important approach to determine primary production is to look at the production of organic matter, using filtered samples at certain time intervals. This can be accomplished by measuring particulate organic carbon (for instance by CHN analyser or mass spectrometer (MS)), or by using tracers like  $^{13}\text{C}$ -DIC or  $^{14}\text{C}$ -DIC (Steeman Nielsen, 1951), and their respective incorporation rate over time (by means of MS and scintillation counter, respectively). Prior to the measurement of organic carbon, samples are treated with acid to remove all residual inorganic carbon from the filters. This technique can, however, easily be modified to also estimate particulate inorganic carbon production, i.e. calcification, by measuring the total particulate carbon (non-acidified samples) and using a mass balance equation. When using the  $^{14}\text{C}$  micro diffusion technique (Paasche & Brubak, 1994), estimates for photosynthesis and calcification can be obtained from the same sample (see chapter 12 of this guide).

The photosynthetic process can also be examined using variable chlorophyll fluorescence measurements. Different techniques are in use, like Pump and Probe (PaP), Pulse Amplitude Modulation (PAM), Fast Repetition Rate Fluorescence (FRRF), Fluorescence Induction and Relaxation (FIRe) that all measure similar parameters, which can be used to elucidate single photosynthetic processes around photosystem II (e.g. Gorbunov *et al.*, 1999; Suggett *et al.*, 2003). If basic parameters, for instance the Photosynthetic Quotient (PQ) and the functional absorption cross section of photosystem II, are known, these measurements can be used to determine photosynthetic rates as well. As photosynthetic oxygen evolution occurs at photosystem II, normally the correlation between variable fluorescence-derived rates and oxygen evolution is highly linear. The techniques used are very sensitive and non-invasive and can hence be used for fieldwork.

### 11.2.2 Biogenic nitrogen fixation

$\text{N}_2$ -fixing cyanobacteria (diazotrophs) are the main source of biologically available nitrogen compounds in large areas of the oligotrophic ocean (Codispoti *et al.*, 2001). Thus, they have an important role in marine ecosystems and biogeochemical cycles (Mulholland, 2007). Recent studies showed that the predominant nitrogen fixer in today's ocean, the colonial cyanobacterium *Trichodesmium spp.*, is strongly affected by increasing  $\text{CO}_2$  concentrations (Barcelos e Ramos *et al.*, 2007; Hutchins *et al.*, 2007; Levitan *et al.*, 2007; Kranz *et al.*, 2009), as are some unicellular nitrogen-fixing cyanobacteria such as *Crocospheera spp.* (Fu *et al.*, 2008). Both their biogeochemical role and their apparent sensitivity to increasing  $\text{CO}_2$  concentrations highlight the importance of studying cyanobacteria in the context of ocean acidification and underline the need for accurate nitrogen fixation rate measurements.

Nitrogen fixation rates can be determined by the acetylene reduction assay (Capone, 1993 and references therein) and the  $^{15}\text{N}$  method (Mulholland & Bernhardt, 2005). Acetylene gas is an analog of molecular  $\text{N}_2$ , and the nitrogenase enzyme catalyses reduction of the triple bond in acetylene to double-bonded ethylene. In this assay, a gas chromatograph is used to measure ethylene production after briefly incubating the  $\text{N}_2$  fixers with added acetylene. The ratio of acetylene reduced to nitrogen fixed is then calculated using a conversion factor (Capone, 1993) and the Bunsen gas solubility coefficient (Breitbarth *et al.*, 2007). For the  $\delta^{15}\text{N}$  technique, isotopically labelled  $\text{N}_2$  gas is introduced to an incubation containing diazotrophs, followed by filter harvesting of the labelled biomass. A mass spectrometer is used to determine the  $^{15}\text{N}$  values of the samples, which are then used to calculate rates of  $\text{N}_2$  fixation. While the acetylene method estimates gross nitrogen fixation rate (enzyme potential), the  $^{15}\text{N}$  method measures net nitrogen production (nitrogen fixed that stays inside the cells) (Mulholland, 2007).

Production rates of particulate organic nitrogen (PON, multiplied by growth rate) by a diazotrophic community can be used as an alternative estimate for nitrogen fixation when direct measurements are not possible. This method only works provided that additional nitrogen sources are known and quantified. In this case, a C/N elemental analyser is used to determine the PON.

### 11.2.3 Organic matter biogeochemistry

Because the number of direct measurements of export flux in the field is small and localised, a widely accepted approach to making large-scale estimates for export is to link export fluxes to element cycling. For instance,

carbon export is often related to nitrogen cycling based on three assumptions: (1) organic matter production follows Redfield stoichiometry (Redfield *et al.*, 1963), (2) the availability of allochthonous inorganic nitrogen, such as nitrate and fixed dinitrogen gas, constrains new biological production (Dugdale & Goering, 1967) and (3) the amount of new production determines the amount of exportable production (Eppley & Peterson, 1979). For ocean acidification research, this close link between export fluxes and nitrogen fluxes leaves, at first sight, very limited space for direct CO<sub>2</sub> sensitivities. However, the general applicability of the Redfield C:N:P ratio to interrelate macro-element fluxes is controversial, and there are numerous examples showing systematic deviation on the organism and species level, with the trophic status of the system, and over time and space (e.g. Banse, 1974; Geider & La Roche, 2002). Nevertheless, deviations of the C:N ratio in particulate organic matter generally are within a range of 20 to 30% (Sterner *et al.*, 2008), which is very narrow compared to terrestrial systems. A somewhat larger decoupling of C and N is observed for processes involving inorganic compounds (Banse, 1994). In order to identify potential effects of ocean acidification on element co-cycling affecting export production, researchers might particularly look for (1) systematic changes in element ratios, compared to the Redfield ratio, (2) effects on the availability of limiting nutrients, specifically nitrogen and (3) effects that lead to qualitative changes in organic matter that in turn affect export efficiencies.

In the context of biological carbon sequestration, several recent studies on the effects of ocean acidification on organic matter production reported systematic changes of element ratios (e.g. Burkhardt *et al.*, 1999; Gervais & Riebesell, 2001; Engel *et al.*, 2005; Leonardos & Geider, 2005; Barcelos e Ramos *et al.*, 2007; Hutchins *et al.*, 2007; Levitan *et al.*, 2007; Riebesell *et al.*, 2007). In these studies, element ratios were calculated from element concentrations in either organic or inorganic, dissolved or particulate form. Analysis of macro-elements include widely accepted standard techniques, such as nutrient analysis via colorimetric methods, elemental analysis (CHN-analyser and MS) after high-temperature combustion, or colorimetric analysis of elements after chemical combustion of organic components. These methods have been described in textbooks (e.g. Grasshoff *et al.*, 1999), and have been evaluated through international programs (see also JGOFS report 19 at [http://ijgofs.whoi.edu/Publications/Report\\_Series](http://ijgofs.whoi.edu/Publications/Report_Series)). Results are typically reported in concentrations of either mass [g l<sup>-1</sup>] or molar [mol l<sup>-1</sup>] units.

Two ways of determining element ratios have to be discriminated: the calculation of concentration ratios, e.g. [C]:[N], and the derivation of reaction rate ratios, e.g. based on a linear regression model  $f_C = a[N] + b$ , where  $a$  is a best estimate of the reaction rate ratio  $\Delta[C]:\Delta[N]$  (e.g. Fanning, 1992). Here, the factor  $a$  describes the co-variation of carbon (C) and nitrogen (N), and is typically derived from the slope of a linear regression of C versus N. Concentration ratios and reaction rate ratios differ for  $b \neq 0$ . Results are typically given in units of mass ([g]:[g]) or as molar ratios ([mol]:[mol]). The uncertainty in determining the slope  $a$ , i.e. its standard error ( $\sigma_a$ ), can be expressed in terms of a root mean square error (RMSE):

$$\sigma_a = \frac{\text{RMSE}}{\sqrt{\sum_{i=1}^M (N_i - \bar{N})^2}} \quad ; \quad (11.1)$$

with

$$\text{RMSE} = \sqrt{\frac{\sum_{i=1}^M (f_C - C)_i^2}{(M - 2)}} \quad ; \quad (11.2)$$

with  $M$  being the total number of observations. When comparing the ratio of mean concentrations, the standard deviation can simply be determined according to the product rule and becomes:

$$\frac{1}{\bar{N}^2} \sqrt{\bar{N}^2 \sigma_C^2 + \bar{C}^2 \sigma_N^2} \quad ; \quad (11.3)$$

where  $\bar{C}$  and  $\bar{N}$  are mean values, and  $\sigma_C$  and  $\sigma_N$  are the standard errors of  $C$  and  $N$ , respectively.

#### 11.2.4 Particle export processes

Observations made during the Joint Global Ocean Flux Study (JGOFS) indicate that 50 to 80% of the vertical flux of carbon through the mesopelagic zone and into the deep ocean occurs by gravitational sinking of particles (e.g. Gardner, 2000; Baliño *et al.*, 2001; Fasham *et al.*, 2001). Sediment trap studies during JGOFS have suggested that ballast minerals influence the export of carbon from the euphotic zone. Particles sinking out of the ocean surface contain both organic matter (OM) and minerals. Minerals (opal, CaCO<sub>3</sub>, and aluminosilicates) typically constitute more than half the mass of sinking particles (Ittekkot & Haake, 1990; Honjo, 1996), and this fraction increases dramatically with depth (Armstrong *et al.*, 2002; Klaas & Archer, 2002). Minerals are important for making low density organic matter sink, and may also protect it from degradation (Hedges & Oades, 1997; Nelson *et al.*, 1999), allowing it to penetrate deeper into the ocean. Armstrong *et al.* (2002) demonstrated that ratios of POC to mineral ballast converge to a nearly constant value (~3 to 7 wt% POC) at depths greater than 1800 m, and Klaas & Archer (2002) showed that variability in the OM flux data might largely be explained ( $r^2 = 85$  to 90%) by the proportions of opal, carbonate, and aluminosilicate ballast. Calcium carbonate appears to be the most important ballast mineral in terms of organic carbon transport (François *et al.*, 2002; Klaas & Archer, 2002).

Will ocean acidification decrease CaCO<sub>3</sub> production and/or increase CaCO<sub>3</sub> dissolution, so that the ballast effect of CaCO<sub>3</sub> will decrease? A decrease in CaCO<sub>3</sub> concentration would theoretically decrease the flux of organic matter, thus decreasing the removal of carbon from the surface ocean. The resulting increase in CO<sub>2</sub> in the surface ocean would enhance acidification, resulting in further dissolution of CaCO<sub>3</sub>, and further decrease in organic matter flux. Could such a decrease in carbon flux be measured with methods that are currently available to directly measure export, such as sediment traps and *in situ* pumps? The time scale of acidification would make the scenario just described proceed at a very slow rate. Even though we have time-series stations where sediment trap material is being collected, the error in mass flux measured is currently too large to allow such a small change in carbonate flux to be determined in the field at least in the near future. On the other hand, sediment traps might be useful in collecting samples of sinking particulate matter that would be useful in studies of dissolution of CaCO<sub>3</sub> or other minerals. Poor trapping efficiency (Yu *et al.*, 2001) of traditional sediment trap designs might bias such collections, however, since trapping efficiency is not equal across all size classes, with smaller particles being winnowed more easily than larger ones. Particle size is one of the parameters that could be used when measuring the effects of ocean acidification. Newer trap designs that avoid some of the problems with winnowing might be more effective (Peterson *et al.*, 1993, 2005; Buesseler *et al.*, 2000, Valdes & Price, 2000). Furthermore, acrylimide-filled dishes in traps are useful to preserve the three-dimensional structure of particles and enable individual size measurements and analysis (Hansen *et al.*, 1996).

*In situ* pumps have also been used to estimate export from surface waters. The deficit in dissolved thorium (<sup>234</sup>Th) found in surface waters is an indication of how much <sup>234</sup>Th export occurs on sinking particles (Coale & Bruland, 1987; Savoye *et al.*, 2006). However, using <sup>234</sup>Th deficits to estimate particle flux is burdened with problems due to non steady-state advection (e.g. Cochran *et al.*, 2009), so that this method is also not accurate enough to measure small changes in flux over time in the field. The C/<sup>234</sup>Th ratio of the particles is used to convert <sup>234</sup>Th export to C export (Buesseler *et al.*, 2006). How will acidification affect C/<sup>234</sup>Th ratios? If acidification were to lower the adsorption coefficient (increase the solubility) of <sup>234</sup>Th for organic matter, C/<sup>234</sup>Th ratios might increase in an acidified system. Perhaps *in situ* pumps can be used to collect samples of suspended and sinking particulate matter that would be useful in the dissolution studies mentioned above. Pumps avoid the winnowing found in many sediment trap designs.

Aggregates play a pivotal role for organic matter cycling and export, as they mediate vertical mass fluxes and element cycling in the ocean (Fowler & Knauer, 1986; Asper *et al.*, 1992). Several studies have highlighted how aggregation processes in the ocean cascade from the nano-scale up to the size of fast settling marine snow (Chin *et al.*, 1998; Engel *et al.*, 2004a; Verdugo *et al.*, 2004), primarily by the process of gel particle formation from high molecular weight organic polymers. Among the types of gel particles that have

been examined more closely are transparent exopolymer particles (TEP). TEP, and specifically the acidic polysaccharides, have been described as facilitating the coagulation of organic components, thereby affecting the partitioning between the pools of dissolved and particulate organic matter as well as organic matter export (Logan *et al.*, 1995; Engel, 2000; Passow, 2002). As photosynthesis rates increase with CO<sub>2</sub> concentration in several phytoplankton species (Rost *et al.*, 2003), the exudation rate of acidic polysaccharide and therefore TEP production may also rise (Engel, 2002). Recent experimental studies indicate that TEP formation is sensitive to ocean acidification (Engel, 2002; Engel *et al.*, 2004b; Mari, 2008), and this sensitivity may affect carbon sequestration in the future ocean (Arrigo, 2007). TEP are gel particles, the concentration of which is determined colorimetrically or microscopically (Passow, 2002; Engel, 2009). Although measurements of TEP are reasonably precise, concentrations of TEP in the field depend on many food chain processes, so that it might be difficult to use measurements over time to separate seasonal or interannual effects from those due to acidification. In addition, CO<sub>2</sub>-induced changes in seawater pH may directly affect the surface charge of particles with potential implications for particle-solute and particle-particle interactions, such as adsorption and aggregation. CO<sub>2</sub> perturbation experiments in mesocosms should prove useful to study direct chemical, physiological or ecological effects of ocean acidification.

### 11.3 Strengths and weaknesses

#### 11.3.1 Primary production

O<sub>2</sub> measurements in discrete samples are easy to perform, require little instrumentation, and are well suited to look at the integrated response of communities. Owing to the incubation times of hours to one day, they are not suited to look at fast responses required for most bioassays. Real-time gas measurements also are relatively easy to perform and do not, with the exception of membrane-inlet mass spectrometry (MIMS), require advanced technical instrumentation. They are useful for short to intermediate incubation times (minutes to hours). These approaches are therefore a good basis to examine the effect of acclimation conditions (e.g. CO<sub>2</sub>/pH) in more detail, e.g. by determining the kinetics of photosynthetic O<sub>2</sub> evolution or C fixation as a function of light or DIC availability. Such data can provide information about underlying mechanisms (e.g. CCMs) being responsible for changes in photosynthesis.

It should be noted that rates of O<sub>2</sub> evolution are usually net rates, as gross O<sub>2</sub> evolution and uptake cannot be separated in the light when O<sub>2</sub> electrodes or optodes are used. MIMS has the advantage that by using <sup>18</sup>O<sub>2</sub>, real gross rates of photosynthesis can be obtained (Peltier & Thibault, 1985). Moreover, the <sup>18</sup>O<sub>2</sub> technique yields information on light-dependent O<sub>2</sub> uptake such as the Mehler reaction or photorespiration, i.e. processes that alter the efficiency of net CO<sub>2</sub> fixation (Falkowski & Raven, 2007). By applying the photosynthetic quotient (PQ), the ratio of O<sub>2</sub> evolution to CO<sub>2</sub> fixation, rates of O<sub>2</sub> evolution can be converted to carbon fixation. The PQ can however change with growth conditions, for instance nutrient availability, and was found to vary between ~1.0 and 1.4 (Williams & Robertson, 1991). As MIMS can measure O<sub>2</sub> evolution in combination with CO<sub>2</sub> uptake and fixation, a detailed analysis on carbon fluxes can be obtained (e.g. Badger *et al.*, 1994; Rost *et al.*, 2007; Kranz *et al.*, 2009).

Gas exchange measurements are not ideally suited for natural phytoplankton assemblages given the small net CO<sub>2</sub> and O<sub>2</sub> fluxes, and have therefore mostly been used in laboratory experiments. In an attempt to increase signal/noise ratios high biomass is often used, which can build up high levels of O<sub>2</sub> (or drawdown of DIC) over the course of the measurement that inhibit photosynthesis and alter other processes. Moreover, as all these real-time gas measurements depend on stable oxygen signals, they require continuous stirring of the medium. The concomitant turbulence may damage the cells, which alters the results such as the derived kinetics. Time-course experiments under assay conditions therefore have to verify that cells are not altered by stirring.

POC production is routinely measured in laboratory experiments. Tracer approaches have the advantage that they are highly sensitive (especially <sup>14</sup>C) and thus are ideally suited for fieldwork, when there is low

photosynthetic activity. Depending on sampling intervals, which can be quite short owing to the high sensitivity,  $^{14}\text{C}$  incubations have also been used in bioassays to obtain information on  $\text{CO}_2$  vs.  $\text{HCO}_3^-$  uptake or DIC affinities (e.g. Elzenga *et al.*, 2000; Hutchins *et al.*, 2007; Tortell *et al.*, 2008). Short-term incubation can also provide gross rates of C fixation, whereas longer incubations tend to measure net photosynthesis. During the process of  $\text{CO}_2$  fixation,  $^{13}\text{C}$  and  $^{14}\text{C}$  isotopes are discriminated by the cell, which has to be accounted for in the calculation. Estimates are moreover dependent on accurate specific activities, and it is also essential to account for blank values, especially in low productivity areas.

Estimations based on filter samples, as opposed to gas measurements in real-time or discrete samples, may be biased by absorption of labeled dissolved organic carbon (DOC) (Turnewitsch *et al.*, 2007). On the other hand, if DOC is a significant part of primary production, as is often the case under nutrient limitation, then estimates based on filtering particles underestimate total carbon fixation.

### 11.3.2 Biogenic nitrogen fixation

The acetylene reduction assay is extremely valuable in fieldwork, since the immediacy of the measurements allows for near real-time readjustments of sampling or experimental protocols while at sea. The major uncertainty associated with this approach is the need to assume an empirical conversion factor (typically 3 or 4:1) to convert moles of acetylene reduced into potential moles of nitrogen fixed.  $^{15}\text{N}$  can be used to determine empirical conversion coefficients from acetylene reduction to nitrogen fixation.

The  $^{15}\text{N}$  method uses dinitrogen gas, the actual substrate for the nitrogenase enzyme, and thus does not need a conversion factor. Another advantage of the  $^{15}\text{N}$  tracer is that it can be used to follow the fixed nitrogen through the planktonic food web (Montoya *et al.*, 1996). Moreover, the  $^{15}\text{N}$  method is easier to set up on field cruises and provides additional information about the carbon content, sometimes giving even simultaneous carbon fixation rates through the addition of  $^{13}\text{C}$ -bicarbonate (Mulholland & Bernhardt, 2005; Hutchins *et al.*, 2007). However, some fraction of the fixed  $^{15}\text{N}$  is exuded by the cell (often as dissolved organic nitrogen, and to a lesser degree as ammonium) and may be harvested on the filter as exopolymer particles or by adsorption. In this case,  $^{15}\text{N}$  measurements will overestimate the cellular  $^{15}\text{N}$  content. In extended incubations, re-assimilation and recycling of released  $^{15}\text{N}$  can also be an issue (Mulholland *et al.*, 2006). Aside from these, no specific problem is associated with the  $^{15}\text{N}$ -technique while doing experiments with  $\text{CO}_2$  manipulation, since the samples are incubated without headspace.

The acetylene method was considered to be more sensitive ( $10^3$  to  $10^4$  times; Hardy *et al.*, 1973), but recent improvements of the  $^{15}\text{N}$  method make both methods equally sensitive (Montoya *et al.*, 1996). When working with  $\text{CO}_2$  manipulated samples, the acetylene reduction assay may be more difficult to handle because this method requires a gas phase. This means that the  $\text{CO}_2$  concentration of the liquid phase (manipulated  $\text{CO}_2$ ) equilibrates with the  $\text{CO}_2$  concentration of the gas phase (ambient  $\text{CO}_2$ ). The effect of  $\text{CO}_2$  on nitrogen fixation will then correspond to  $\text{CO}_2$  concentrations that are slightly different (depending on the headspace to liquid volume ratio) from those initially adjusted in the liquid phase. The change of the  $\text{CO}_2$  concentration may even influence the response over the short incubation period. For that reason, keeping the volume ratio of the gas phase to the liquid phase as small as possible will minimise the difference between the  $\text{CO}_2$  levels.

The shortcoming of estimating nitrogen production rates from changes in PON is the lower sensitivity of the CHN-analyser, compared to MS and GC. Additionally, PON determination suffers from several of the same issues as the  $^{15}\text{N}$  method, for example dissolved organic nitrogen (DON) adsorption. Due to degradation and remineralisation of PON by heterotrophic bacteria associated with diazotrophs during the incubation, only net fixation rates can be estimated. Since PON production may occur by other organisms in mixed communities, this application is limited to culture studies.

Extra care should be given to the mixing of the cultures in general, since filamentous cyanobacteria are very sensitive to high turbulence. During the incubation carried out before nitrogen fixation rate measurements, it is important to shorten the equilibration time between the gas and the liquid phase. In this case we advise the use

of a shaking plate during the incubation (low/mid velocity). Additionally, samples should be treated carefully and quickly to minimise in- or out-gassing.

### 11.3.3 Organic matter biogeochemistry

The instrumentation for determining biogeochemical elements like carbon, nitrogen and phosphorus in bulk dissolved organic matter (DOM) and particulate organic matter (POM), for example by nutrient autoanalyser, CHN-analyser or MS, is generally advanced, and enables high precision (<5%) measurements. Coupled to auto-sampling devices, a large number of samples can be processed in reasonable time. On-site preparation and storage of samples allows for analysis at a later time, although attention must be paid to certain storage requirements, i.e. uninterrupted cooling/freezing, and/or specific poisoning of samples (e.g. Grasshof *et al.*, 1999). Due to the relative ease of obtaining and analysing samples, determining element concentrations and ratios in particulate and dissolved matter qualifies for most kinds of experimental and field approaches. If an element is determined in its inorganic as well as its organic forms during an experiment, this approach can also be helpful to identify potential sources of errors or losses, as mass must be conserved in enclosed systems. The major limitation of this biogeochemical approach for quantifying production and export processes is that the information obtained is quite unspecific with respect to the source, turnover or quality of the material. Determining isotopic composition and fractionation in specific compounds such as fatty acids, or following the fate of stable isotopes such as <sup>15</sup>N after addition, can help to discriminate the origin of the material and its participation in autotrophic or heterotrophic processes (Dugdale & Goering, 1967; Peterson & Fry, 1987; Boschker & Middleburg, 2002; McCallister *et al.*, 2004; Veuger *et al.*, 2007). Here, care must be taken to thoroughly remove inorganic carbon prior to POC measurements as <sup>13</sup>C signatures of PIC and POC are different (Komada *et al.*, 2008). In general, attention must be paid to high background loads of organic matter especially in experimental and coastal field investigations, as these potentially decrease the ratio between the CO<sub>2</sub> treatment effect and the noise.

## 11.4 Potential pitfalls

### 11.4.1 Experimental set-up

CO<sub>2</sub> perturbation studies with plankton are often conducted using enclosures that range from a few ml batch incubations to much larger mesocosms (see chapters 5 and 6). Here, plankton organisms are usually incubated with a fixed initial amount of nutrients, while the carbonate system is perturbed by CO<sub>2</sub> aeration or direct pH adjustment (see chapter 2). During the course of the experiment, the build-up of organic biomass is accompanied by the drawdown of nutrients and inorganic carbon resources. Due to the resulting changes in nutrient availability, the production rates and element stoichiometry of organic matter can vary strongly over the course of experiments (Antia *et al.*, 1963; Banse, 1994; Biddanda & Benner, 1997; Engel *et al.*, 2002). Gervais & Riebesell (2001) showed that besides the absolute value, the variability of element ratios in particulate matter also increased with increasing biomass build-up during a CO<sub>2</sub> perturbation experiment (Figure 11.2). Besides nutrients, light availability and diurnal cycles potentially co-determine organic matter production rates and element stoichiometry in ocean acidification experiments (Burkhardt *et al.*, 1999) (Figure 11.3).

Although the consumption and reduction of nutrient resources in batch or enclosure experiments mimic natural situations in eutrophic waters, for example the “bloom” situation, they also involve the difficulty of identifying potentially small effects of ocean acidification against inherently large variations in organic C, N and P production rates. Batch experiments therefore require a sufficiently large number of replicate treatments, and high-precision measurements of co-determining factors, such as nutrients, light and temperature, to determine their variability and to identify the CO<sub>2</sub>-effect. Moreover, initial synchronisation of cultures, the timing of sampling and of course the simultaneous sampling, are very important in comparing CO<sub>2</sub> treatments and have to be carefully considered during acidification studies.

A particular problem of incubation experiments may arise when cells in the ocean acidification treatments exhibit differences in length of the initial lag growth phase, and consequently in the on-set of exponential growth and drawdown of nutrients. This may, for example, be the case when cultures are not pre-adapted to the ocean acidification setting. In this case, the comparability of treatments with respect to nutrient availability may no longer be given. It is therefore important to monitor the development of the cells throughout the experiment, since a single or sporadic sampling may not capture the cell's response at the same growth stage.

Problems associated with the build-up of high biomass in batch incubations, for example significant changes in nutrient availability, self-shading, aggregation and sinking, can be alleviated in semi-continuous and dilute cultures, which require regular dilutions to keep cells exponentially growing at low densities. This is, however, laborious in long-term studies and studies conducted at naturally low nutrient concentration. For this purpose, the continuous culture (chemostat, turbidostat) is an alternative and favourable set-up (see chapter 5).

#### 11.4.2 Transferability to the ecosystem level

As in all ecological studies, microbial processes in pelagic systems can be studied from an isolated perspective such as “what is the magnitude of microbial production?” or “what is the microbial diversity?” Alternatively, questions can be asked in a broader, more ecosystem-related, context such as “what factor in the ecosystem controls microbial production” or “what are the mechanisms maintaining microbial diversity?” At times, aquatic microbial ecology may seem overly dominated by the first type of questions. Historically this may be due to a lack of appropriate methods, only changing in the early 1980s, when appropriate methods for enumeration and activity measurements became available. The subsequent development in the field has strongly improved this situation, now allowing both types of questions to be asked, and at much more detailed levels than previously possible.

In relation to ocean acidification and its potential effects on microbial processes and the biological

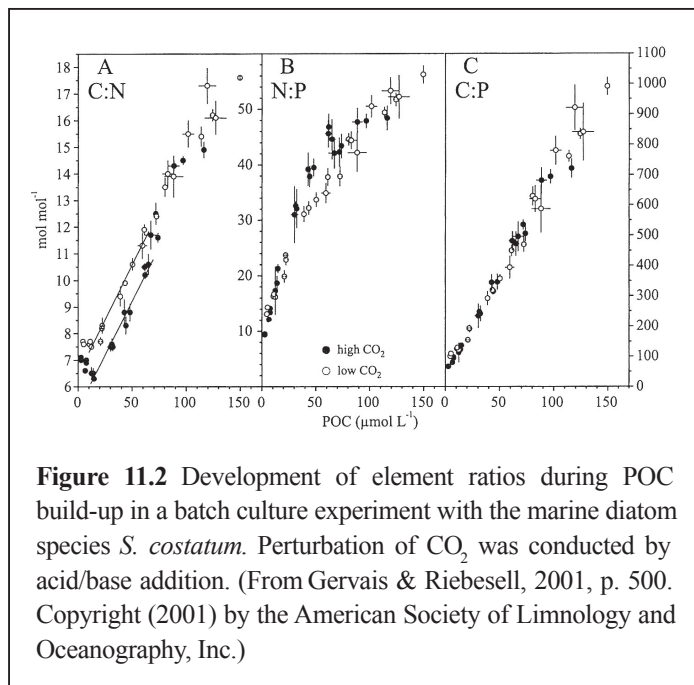

**Figure 11.2** Development of element ratios during POC build-up in a batch culture experiment with the marine diatom species *S. costatum*. Perturbation of CO<sub>2</sub> was conducted by acid/base addition. (From Gervais & Riebesell, 2001, p. 500. Copyright (2001) by the American Society of Limnology and Oceanography, Inc.)

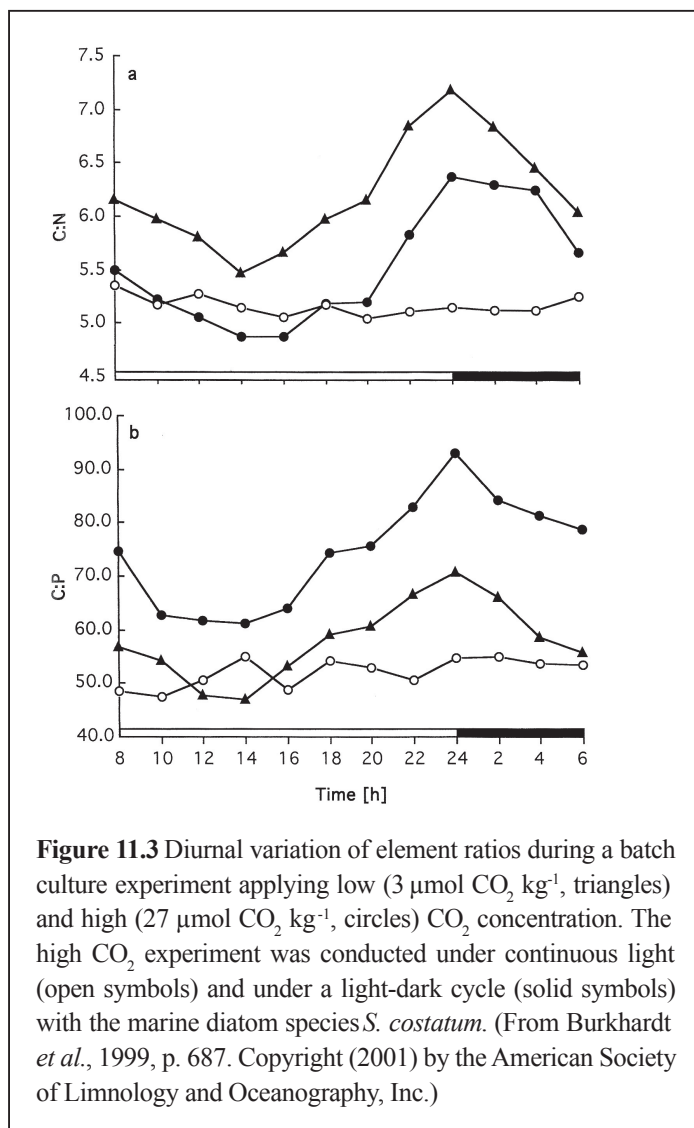

**Figure 11.3** Diurnal variation of element ratios during a batch culture experiment applying low (3 μmol CO<sub>2</sub> kg<sup>-1</sup>, triangles) and high (27 μmol CO<sub>2</sub> kg<sup>-1</sup>, circles) CO<sub>2</sub> concentration. The high CO<sub>2</sub> experiment was conducted under continuous light (open symbols) and under a light-dark cycle (solid symbols) with the marine diatom species *S. costatum*. (From Burkhardt *et al.*, 1999, p. 687. Copyright (2001) by the American Society of Limnology and Oceanography, Inc.)

pump in natural systems, awareness of the two perspectives is of particular importance. Detection of an acidification effect on, for example, microbial production may be interesting in itself, but does not provide much insight unless it is known whether this results from a direct effect on the cell's physiology or an indirect effect caused by food web interactions, for example from increased production of labile organic matter by phytoplankton. Two direct effects of acidification on the microbial food web presently receive the most attention; the potential reduction in calcification and the change in C:N:P stoichiometry of primary production (Riebesell *et al.*, 2007; Bellerby *et al.*, 2008; Rost *et al.*, 2008).

The “model organism” for calcification within the microbial food web is *Emiliana huxleyi*, where the direct effect of acidification on the formation of coccoliths can be studied as an isolated phenomenon in laboratory cultures (De Bodt *et al.*, 2008), or in mixed natural communities in mesocosms (Delille *et al.*, 2005; Engel *et al.*, 2005; Paulino *et al.*, 2008). Transferring such observations to an understanding of the mechanisms in the microbial part of the ecosystem does however immediately expose our lack of understanding of trophic couplings in the microbial food web. When observing the success of *Emiliana huxleyi* in many mesocosm studies, a tempting conceptual model is that *E. huxleyi* is slightly better protected against microzooplankton grazing than other small flagellates, and thus slowly can outgrow these, potentially explaining the occurrence of large *E. huxleyi* blooms. The possible consequence is a bloom dominated by a single species, reaching a density sufficient for the support of species-specific lytic viruses – and thus leading to the observed viral-induced collapses of the bloom (Bratbak *et al.*, 1993, 1996). The biogeochemical consequences of such a scenario are potentially large: while grazing may lead to vertical export of the coccoliths and thus of alkalinity, viral lysis will release the non-sinking individual coccoliths in the photic zone. The implication would be a complicated feedback between acidification and vertical alkalinity distribution, mediated through the interactions of the microbial loop. However, the experimental evidence for crucial assumptions, for example that the coccoliths serve a role in predator defense, is lacking.

The observed effect of an increased C:N-stoichiometry in primary production at increased p(CO<sub>2</sub>) (Riebesell *et al.*, 2007) illustrates the potential complexity in translating an understanding of a direct microbial effect into an understanding of its consequences for the microbial ecosystem and the biological pump. If bacterial growth is limited by the availability of labile organic carbon, such extra organic input may increase bacterial consumption of mineral nutrients, with a potential reduction in mineral nutrient limited primary production as a result (Thingstad *et al.*, 2008). The resulting net changes inside the photic zone ecosystem are difficult to predict, both in terms of autotroph-heterotroph balance and community composition of heterotrophic prokaryotes. Predicting the consequences for the amount, the stoichiometric composition, and degradability of material exported via sinking particles or dissolved organic material, is equally difficult.

One lesson to be drawn from the, by now, extensive set of mesocosm experiments performed with different perturbations of the photic zone microbial ecosystem, is the need to be cautious in generalising from single experiments. The system's response to a perturbation depends not only on the nature of the perturbation, but also on the state of the system at the time of perturbation (presence of diatoms, limiting factor for bacterial growth, abundance of mesozooplankton, microbial species composition etc.). With the present level of understanding of how the food web works as a system, generalisations from single experiments thus bear the risk of, in hindsight, being naive.

Moreover, prediction of future ecosystem responses has to account for possible acclimation and/or adaptation of species to ocean acidification. Most laboratory and mesocosm studies performed so far have been restricted to a few days or weeks, excluding evolutionary changes. Evolution may be particularly rapid in microbial communities with generation times of hours to days. Different responses to acidification may occur among different strains of the same species, such as observed for *E. huxleyi* (Langer *et al.*, 2009). Strain selection and/or evolution are therefore likely to occur during real-time ocean acidification and are difficult to include in perturbation studies. Long-term studies are therefore necessary to investigate the potential of acclimation and adaptation to acidification of marine microorganisms.



## 11.5 Suggestions for improvements

One of the major uncertainties with regard to how changes in organic matter will affect export processes is that we do not know if the produced organic matter effectively contributes to sinking fluxes or rather stays suspended, or whether settling velocities of particles are so slow that degradation would likely occur within the upper water column. Most manipulative systems are on the scale of a few litres to cubic meters, and therefore limit the direct determination of export fluxes.

If we suppose, for example, that changes in organic matter stoichiometry primarily occur on the production side, based for example on the sensitivity of carbon and nitrogen acquisition to  $\text{CO}_2$ , we also need to know how these elements are partitioned thereafter. Several studies have indicated that unbalanced acquisition of elements results in exudation of the excess element into the dissolved phase; microbial processes and abiotic coagulation processes then determine whether these elements will be transformed into particulate organic matter, and will also determine the size distribution of particles, and therefore the settling velocity of particles. Hence, more information on the processes associated with the partitioning of and size distribution of particles can greatly improve our understanding of the responses of organic and export production to ocean acidification.

Moreover, our understanding of organic matter biogeochemistry has been deeply impacted by the microscopic inspection of the particles produced. What we directly see under the microscope are mostly plankton organisms. What we do not see unless we use compound specific stains are gel particles that especially form during unbalanced growth, such as during nutrient limitation. Carbohydrate gel particles, for example TEP, can be mostly responsible for the increase in carbon to nitrogen or phosphorus ratios during phytoplankton blooms (Engel *et al.*, 2002; Schartau *et al.*, 2007). Early studies already indicated that POC concentration is not equivalent to the carbon content of organisms, which at times contribute less than 50% to POC (Riley, 1970). This should be taken into account when deriving cellular production or cell quotas by normalising POC to cell abundance. Because there is no *a priori* constraint for element ratios in extracellular organic matter, improving our understanding of element partitioning can help to better estimate effects of ocean acidification.

## 11.6 Data reporting

In order to assess how acidification affects biogeochemical, physiological and ecological processes, it is recommended that data be normalised. Normalisation can be defined as “a mathematical process that adjusts for differences among data from varying sources in order to create a common basis for comparison.” ([www.hud.gov/offices/pih/programs/ph/phecc/definitions.cfm](http://www.hud.gov/offices/pih/programs/ph/phecc/definitions.cfm)). What we choose to normalise to, i.e. the choice that we make for the common basis for comparison, depends on the context. For many biologists, the obvious choice is to normalise to the number of individuals, whereas for geochemists it might be more appropriate to normalise to the concentration of a particular element, for example nitrogen. Perhaps the most widely used example of normalisation in biological oceanography is the division of primary productivity (units of  $\text{g C m}^{-3} \text{d}^{-1}$ ) by chlorophyll *a* concentration (units of  $\text{g Chl } a \text{ m}^{-3}$ ) to obtain the assimilation number (units of  $\text{g C (g Chl } a)^{-1} \text{d}^{-1}$ ). Much oceanographic research involves identifying controlling or limiting factors of ecological and biogeochemical processes (Arrigo, 2005). With regard to ocean acidification research, we are interested in both:

1. the effects of increased  $p(\text{CO}_2)$  in a more acidic ocean on for example  $\text{CO}_2$ -limitation of photosynthesis and  $\text{N}_2$ -fixation, and
2. the effect of acidification on the coupling of biogeochemical and ecological processes in relation to other limiting factors including light, nutrients, iron and/or other trace elements.

There are two main ways to characterise limitation, namely in terms of limitation of the yield of a process or limitation of the rate of a process (Cullen *et al.*, 1992). Yield is the biomass that is produced, with

typical units of g m<sup>-2</sup> or g m<sup>-3</sup>. Rate determines how long it takes to reach the yield, and is often expressed as a specific growth rate with units of d<sup>-1</sup>. These two types of limitation are often referred to as Liebig's law and Blackman's law.

**Liebig's law** is based on limitation imposed on the yield by the availability of nutrients. It applies to situations where biomass is produced more or less in proportion to the amount of resource consumed. Strictly, Liebig's law is a special case of yield limitation in which yield is assumed to be controlled by only one limiting factor at a time (e.g., it is a threshold type of limitation and does not allow co-limitation). Co-limitation may be more prevalent than commonly assumed. Even if any given component of the community is limited by only one resource, different components may be limited by different resources leading to co-limitation at the community level. Assessment of yield limitation requires information on element composition, with the biomass yield for non-limiting elements determined by their multiples (e.g. indices A, B, C, D, Z in equation (11.4)) of the limiting element, where phosphorus is commonly taken as the basis for comparison (e.g. equation (11.4)).

$$[\text{Organic}]:[\text{Inorganic}] = [\text{C}_A\text{H}_B\text{O}_C\text{N}_D\text{PFe}_Z]:[\text{CaCO}_3, \text{SiO}_2] \quad (11.4)$$

Within the organic fraction, a common reference value is the Redfield ratio, but it is well documented that there can be significant deviations from the Redfield proportions of 106C:16N:1P (Geider & LaRoche, 2002). The Redfield ratio can also be extended to include trace elements such as iron (Fe) (Morel & Hudson, 1984). It is also necessary to consider the ratio of hard parts (such as CaCO<sub>3</sub> and opal) to soft tissue, which depends on the organisms present as well as the growth conditions. Thus, even when research is focused on element stoichiometry, it will be informative to have supplementary information on diversity and abundance of the species that make up the ecological community. Yield limitation can apply to both organic and inorganic components of biomass. For example, yield of CaCO<sub>3</sub> can be expressed as:

$$Y_{\text{CaCO}_3} = M_N \varepsilon_N \left( \frac{\text{CaCO}_3}{\text{N}} \right); \quad (11.5)$$

where N refers to a nutrient, which may be nitrogen or some other nutrient (e.g. Fe).  $Y_{\text{CaCO}_3}$  is the yield of CaCO<sub>3</sub> from a region of the ocean,  $M_N$  is the mass of the limiting nutrient "N" transported into that region,  $\varepsilon_N$  is the efficiency of uptake and retention of nutrient "N" by calcifiers and  $\left( \frac{\text{CaCO}_3}{\text{N}} \right)$  describes the ratio of CaCO<sub>3</sub> to N in calcifiers.

The upper limit on yield is ultimately set by the supply of a limiting nutrient,  $M_N$ . However, the achieved yield depends also on the efficiency of capture of that nutrient by calcifiers and the ratio of CaCO<sub>3</sub> production to nutrient assimilation. Here the term nutrient is used in a generic sense and both dissolved and particulate nutrients, including nutrients contained in organic matter (both living and dead). Normalisation in this context involves determining the proportion of the nutrient contained in a population of interest and the ratio of CaCO<sub>3</sub> to N within this target group.

**Blackman's law** applies to situations when the rate is determined by the physical environment or when the limiting resource is replenished as it is consumed. Thus, Blackman limitation applies to the direct effects of light, temperature and pH, but can apply to nutrients if these are replenished (e.g. CO<sub>2</sub> from HCO<sub>3</sub><sup>-</sup>; Fe from Fe bound to ligands (Fe-L)). Strictly, Blackman's law is a special case of rate limitation in which growth rate is determined by only one limiting factor (e.g., limitation of growth rate by one factor will be replaced by another factor once an upper limit imposed by the first factor is reached).

There are a number of different biomass variables to which productivity can be normalised to obtain a biomass-specific rate (Table 11.1). These include the production to biomass ratio (P:B), the assimilation number and the nitrogen-use efficiency.

**Table 11.1** Examples of typical data normalisations in biological oceanography.

Symbol	Definition	Typical units	Notes
$P_{\text{cell}} = \frac{P}{\text{cell}}$	Cell-specific productivity	g C cell <sup>-1</sup> d <sup>-1</sup>	Depends on organism size: change in rate may occur due to change in cell size at constant biomass-specific rate.
$\mu = \frac{P}{B} = \frac{1}{B} \frac{dB}{dt}$	Specific growth rate ( $\mu$ ) = production to biomass ratio	d <sup>-1</sup>	May depend on choice of biomass variable (e.g. unbalanced growth).
$P^{\text{Chl}} = \frac{P}{\text{Chl}}$	Assimilation number	g C (g Chl) <sup>-1</sup> d <sup>-1</sup>	Requires knowledge of C:Chl to obtain growth rate.
$\frac{P}{N}$	Nitrogen use efficiency	mol C (mol N) <sup>-1</sup> d <sup>-1</sup>	A similar approach can be applied to other elements.

The P to B ratio is used when P and B are measured in terms of the same biomass index, say C or N. It is used most often when describing growth or productivity of animal populations. However, it also applies to microbial populations. When used with microbes, the P to B ratio is often referred to as the specific growth rate, often designated  $\mu$ . Other biomass-specific rates employ mixed currencies. Examples include the assimilation number,  $P^{\text{Chl}}$ , used for phytoplankton because it is easier to measure chlorophyll *a* than phytoplankton carbon. The nitrogen use efficiency was originally used with vascular plants, or plant leaves, but is also applicable to phytoplankton and other microbes. In analogy with nitrogen use efficiency, the use efficiencies for other elements, such as Fe, can also be measured (Raven, 1990). These different ways of expressing biomass-specific rates may not show the same response to ocean acidification.

Productivity is a rate per unit volume or surface area, and is obtained by multiplying the biomass by the biomass-specific rate:  $P = P^B \times B$ . For example, the rate of calcium carbonate production depends on the biomass of calcifiers, their growth rate and the CaCO<sub>3</sub> to biomass ratio:

$$P_{\text{CaCO}_3} = B_{\text{calcifiers}} \times \mu_{\text{calcifiers}} \times \left( \frac{\text{CaCO}_3}{B} \right); \quad (11.6)$$

where  $P_{\text{CaCO}_3}$  is the volume- or area-specific CaCO<sub>3</sub> production rate,  $B_{\text{calcifiers}}$  = the biomass of calcifiers per unit volume or area,  $\mu_{\text{calcifiers}}$  = the specific growth rate (P:B) of calcifiers, and  $\left( \frac{\text{CaCO}_3}{B} \right)$  = the ratio of CaCO<sub>3</sub> to N in calcifiers.

Here, normalisation includes both (1) the specific growth rate and (2) the (element or mass) ratio of calcium carbon to biomass. Biomass can be expressed in terms of N, C or abundance.

As experimentalists, we often choose biomass variables for convenience or for answering one type of question. Microbiologists, for example, often normalise rates to the number of cells in a sample. Examples of normalising variables are given in Table 11.2.

**Table 11.2** Specifications of data normalisation.

	<i>Normalising to the number of individuals</i>
Individual organisms	The individual is one of the basic hierarchical categories in biology. Individuals obtain resources from the environment, grow and reproduce. Many biological and ecological processes scale with the size of the individual. These include metabolic and growth rates, encounter rates, aggregation rates (and hence grazing and sinking rates).
Abundance (population size)	The population is one of the basic hierarchical categories in ecology. Natural selection operates on populations of organisms.
	<i>Normalising to biomass</i>
Biomass	Although physiological processes and population dynamics require knowledge of individuals and populations, many ecological and biogeochemical processes require normalisation of rates to some measure of biomass.
Chlorophyll <i>a</i>	Chlorophyll <i>a</i> can be measured readily and unambiguously. It is the most common measure of phytoplankton abundance. Other variables often scale with chlorophyll <i>a</i> (e.g. bacterial and zooplankton abundance or activity).
Nitrogen	Nitrogen is a key nutrient element in ocean biogeochemistry. The C:N of functional components of organisms falls within a narrow range (5 to 10 g C : g N). Primary production in much of the ocean is nitrogen limited (or N and P co-limited). In HNLC regions, N assimilation and CO <sub>2</sub> fixation are often limited by the same factors (Fe and/or light).
Organic carbon	Carbon is a key element in ocean and atmospheric biogeochemistry.

**11.7 Recommendations for standards and guidelines**

1. In order to identify the direct response of an organism to ocean acidification, potential co-effects of nutrient availability, light, diurnal cycles, temperature, and if applicable, community interactions (e.g. bacteria) need to be assessed carefully.
2. Since the response of a community depends not only on the type and strength of the perturbation, but also on ecological interactions, the impact of ocean acidification on organic and export production needs to be investigated at the ecosystem level, for example via mesocosm and field experiments. This enables the consideration of key features such as the food web structure, bottom-up control, top-down control and the type of growth limitation.
3. A better interpretation of changes in organic matter production with respect to export, can be obtained when the size and quality of organic matter (e.g. cellular material, mineral ballast, gels) is determined.

## 11.8 References

- Antia N. J., McAllister C. D., Parsons T. R., Stephens K. & Strickland J. D. H., 1963. Further measurements of primary production using a large volume plastic sphere. *Limnology and Oceanography* 8:166-183.
- Armstrong R. A., Lee C., Hedges J. I., Honjo S. & Wakeham S. G., 2002. A new, mechanistic model for organic carbon fluxes in the ocean based on the quantitative association of POC with ballast minerals. *Deep-Sea Research II* 49:219-236.
- Arrigo K. R., 2005. Marine microorganisms and global nutrient cycles. *Nature* 437:349-355.
- Arrigo K. R., 2007. Carbon cycle: marine manipulations. *Nature* 450:491-492.
- Asper V. L., Deuser W. G., Knauer G. A. & Lohrenz S. E., 1992. Rapid coupling of sinking particle fluxes between surface and deep ocean waters. *Nature* 357:670-672.
- Badger M. R., Andrews T. J., Whitney S. M., Ludwig M., Yellowlees D. C., Leggat W. & Price G. D., 1998. The diversity and coevolution of Rubisco, plastids, pyrenoids, and chloroplast-based CO<sub>2</sub>-concentrating mechanisms in algae. *Canadian Journal of Botany* 76:1052-1071.
- Badger M. R., Palmqvist K. & Yu J. W., 1994. Measurement of CO<sub>2</sub> and HCO<sub>3</sub><sup>-</sup> fluxes in cyanobacteria and microalgae during steady-state photosynthesis. *Physiologia Plantarum* 90:529-536.
- Baliño B. M., Fasham M. J. R. & Bowles M. C. (Eds.), 2001. Ocean biogeochemistry and global change, 36 p. Stockholm: International Geosphere-Biosphere Programme (IGBP).
- Banse K., 1974. Interpretation of data for carbon-to-nitrogen ratio of phytoplankton. *Limnology and Oceanography* 19:695-699.
- Banse K., 1994. Uptake of inorganic carbon and nitrate by marine plankton and the Redfield ratio. *Global Biogeochemical Cycles* 8:81-84.
- Barcelos e Ramos J., Biswas H., Schulz K. G., LaRoche J. & Riebesell U., 2007. Effect of rising atmospheric carbon dioxide on the marine nitrogen fixer *Trichodesmium*. *Global Biogeochemical Cycles* 21, GB2028. doi:10.1029/2006GB002898.
- Beardall J., 1991. Effects of photon flux density on the "CO<sub>2</sub> concentrating mechanism" of the cyanobacterium *Anabaena variabilis*. *Journal of Plankton Research* 13:133-141.
- Bellerby R. G. J., Schulz K. G., Riebesell U., Neill C., Nondal G., Heegaard E., Johannessen T. & Brown K. R., 2008. Marine ecosystem community carbon and nutrient uptake stoichiometry under varying ocean acidification during the PeECE III experiment. *Biogeosciences* 5:1517-1527.
- Biddanda B. & Benner R., 1997. Carbon, nitrogen, and carbohydrate fluxes during the production of particulate and dissolved organic matter by marine phytoplankton. *Limnology and Oceanography* 42:506-518.
- Boschker H. T. S. & Middelburg J. J., 2002. Stable isotopes and biomarkers in microbial ecology. *FEMS Microbiology Ecology* 40:85-95.
- Boyd P. W. & Trull T. W., 2007. Understanding the export of biogenic particles in oceanic waters: is there consensus? *Progress in Oceanography* 72:276-312.
- Bratbak G., Egge J. K. & Heldal M., 1993. Viral mortality of the marine alga *Emiliania huxleyi* (Haptophyceae) and termination of algal blooms. *Marine Ecology Progress Series* 93:39-48.
- Bratbak G., Wilson W. & Heldal M., 1996. Viral control of *Emiliania huxleyi* blooms? *Journal of Marine Systems* 9:75-81.
- Breitbarth E., Oschlies A. & LaRoche J., 2007. Physiological constraints on the global distribution of *Trichodesmium* - effect of temperature on diazotrophy. *Biogeosciences* 4:53-61.
- Broecker W. S., 1991. Keeping global change honest. *Global Biogeochemical Cycles* 5:191-192.
- Buesseler K. O., Benitez-Nelson C. R., Moran S. B., Burd A., Charette M., Cochran J. K., Coppola L., Fisher N. S., Fowler S. W., Gardner W., Guo L. D., Gustafsson Ö., Lamborg C., Masque P., Miquel J. C., Passow U., Santschi P. H., Savoye N., Stewart G. & Trull T., 2006. An assessment of particulate organic carbon to thorium-234 ratios in the ocean and their impact on the application of <sup>234</sup>Th as a POC flux proxy. *Marine Chemistry* 100:213-233.

- Buesseler K. O., Steinberg D. K., Michaels A. F., Johnson R. J., Andrews J. E., Valdes J. R. & Price J. F., 2000. A comparison of the quantity and composition of material caught in a neutrally buoyant versus surface-tethered sediment trap. *Deep-Sea Research I* 47:277-294.
- Burkhardt S., Zondervan I. & Riebesell U., 1999. Effect of CO<sub>2</sub> concentration on C:N:P ratio in marine phytoplankton: a species comparison. *Limnology and Oceanography* 44:683-690.
- Capone D. G., 1993. Determination of nitrogenase activity in aquatic samples using the acetylene reduction procedure. In: Kemp P. F., Sherr B. F., Sherr E. B. & Cole J. J. (Eds.), *Handbook of methods in aquatic microbial ecology*, pp. 621-631. Boca Raton: Lewis Publishers.
- Chin W. C., Orellana M. V. & Verdugo P., 1998. Spontaneous assembly of marine dissolved organic matter into polymer gels. *Nature* 391:568-572.
- Coale K. H. & Bruland K. W., 1987. Oceanic stratified euphotic zone as elucidated by <sup>234</sup>Th:<sup>238</sup>U disequilibria. *Limnology and Oceanography* 32:189-200.
- Cochran J. K., Miquel J. C., Armstrong R., Fowler S. W., Masqué P., Gasser B., Hirschberg D., Szlosek J., Rodriguez y Baena A. M., Verdeny E. & Stewart G. M., 2009. Time-series measurements of <sup>234</sup>Th in water column and sediment trap samples from the northwestern Mediterranean Sea. *Deep-Sea Research II* 56:1487-1501.
- Codispoti L. A., Brandes J. A., Christensen J. P., Devol A. H., Naqvi S. W. A., Paerl H. W. & Yoshinari T., 2001. The oceanic fixed nitrogen and nitrous oxide budgets: moving targets as we enter the anthropocene? *Scientia Marina* 65:85-105.
- Cullen J. J., Yang X. & MacIntyre H. L., 1992. Nutrient limitation of marine photosynthesis. In: Falkowski P. G. & Woodhead A. V. (Eds.), *Primary productivity and biogeochemical cycles in the sea*, pp. 69-88. New York: Plenum Press.
- De Bodt C., Harlay J. & Chou L., 2008. Biocalcification by *Emiliania huxleyi* in batch culture experiments. *Mineralogical Magazine* 72:251-256.
- Delille B., Harlay J., Zondervan I., Jacquet S., Chou L., Wollast R., Bellerby R. G. J., Frankignoulle M., Borges A. V., Riebesell U. & Gattuso J.-P., 2005. Response of primary production and calcification to changes of pCO<sub>2</sub> during experimental blooms of the coccolithophorid *Emiliania huxleyi*. *Global Biogeochemical Cycles* 19, GB2023. doi:10.129/2004GB002318.
- Dugdale R. C. & Goering J. J., 1967. Uptake of new and regenerated forms of nitrogen in primary productivity. *Limnology and Oceanography* 23:196-206.
- Elzenga J. T. M., Prins H. B. A. & Stefels J., 2000. The role of extracellular carbonic anhydrase activity in inorganic carbon utilization of *Phaeocystis globosa* (Prymnesiophyceae): a comparison with other marine algae using the isotopic disequilibrium technique. *Limnology and Oceanography* 45:372-380.
- Engel A., 2000. The role of transparent exopolymer particles (TEP) in the increase in apparent particles stickiness ( $\alpha$ ) during the decline of a diatom bloom. *Journal of Plankton Research* 22:485-497.
- Engel A., 2002. Direct relationship between CO<sub>2</sub> uptake and transparent exopolymer particles production in natural phytoplankton. *Journal of Plankton Research* 24:49-53.
- Engel A., 2009. Determination of marine gel particles, practical guidelines for the analysis of seawater. In: Wurl O. (Ed.), pp. 125-142. Boca Raton: CRC Press.
- Engel A., Goldthwait S., Passow U. & Alldredge A., 2002. Temporal decoupling of carbon and nitrogen dynamics in a mesocosm diatom bloom. *Limnology and Oceanography* 47:753-761.
- Engel A., Thoms S., Riebesell U., Rochelle-Newall E. & Zondervan I., 2004a. Polysaccharide aggregation as a potential sink of marine dissolved organic carbon. *Nature* 428:929-931.
- Engel A., Delille B., Jacquet S., Riebesell U., Rochelle-Newall E., Terbrüggen A. & Zondervan I., 2004b. Transparent exopolymer particles and dissolved organic carbon production by *Emiliania huxleyi* exposed to different CO<sub>2</sub> concentrations: a mesocosm experiment. *Aquatic Microbial Ecology* 34:93-104.

- Engel A., Zondervan I., Aerts K., Beaufort L., Benthien A., Chou L., Delille B., Gattuso J.-P., Harlay J., Heemann C., Hoffmann L., Jacquet S., Nejstgaard J., Pizay M.-D., Rochelle-Newall E., Schneider U., Terbruggen A. & Riebesell U., 2005. Testing the direct effect of CO<sub>2</sub> concentration on a bloom the coccolithophorid *Emiliania huxleyi* in mesocosm experiments. *Limnology and Oceanography* 50:493-507.
- Eppley R. W. & Peterson B. J., 1979. Particulate organic matter flux and planktonic new production in the deep ocean. *Nature* 282:677-680.
- Falkowski P. G. & Raven J. A., 2007. *Aquatic photosynthesis*. 484 p. Princeton: Princeton University Press.
- Fanning K. A., 1992. Nutrient provinces in the Sea: concentration ratios, reaction rate ratios and ideal covariance. *Journal of Geophysical Research- Oceans* 97:5693-5712.
- Fasham M. J. R., Baliño B. M. & Bowles M. C. (Eds.), 2001. A new vision of ocean biogeochemistry after a decade of the Joint global Ocean flux study (JGOFS), *Ambio special report* 10, 31 p. Stockholm: Royal Swedish Academy of Sciences.
- Fowler S. W. & Knauer G. A., 1986. Role of large particles in the transport of elements and organic compounds through the oceanic water column. *Progress in Oceanography* 16:147-194.
- François R., Honjo S., Krishfield R. & Manganini S., 2002. Factors controlling the flux of organic carbon to the bathypelagic zone of the ocean. *Global Biogeochemical Cycles* 16, 1087. doi:10.1029/2001GB001722.
- Fu F.-X., Mulholland M. R., Garcia N. S., Beck A., Bernhardt P. W., Warner M. E., Sañudo-Wilhelmy S. A. & Hutchins D. A., 2008. Interactions between changing pCO<sub>2</sub>, N<sub>2</sub> fixation, and Fe limitation in the marine unicellular cyanobacterium *Crocospaera*. *Limnology and Oceanography* 53:2472-2484.
- Gardner W. D., 2000. Sediment trap sampling in surface waters. In: Hanson R. B., Ducklow H. W. & Field J. G. (Eds.), *The changing ocean carbon cycle: a midterm synthesis of the Joint Ocean Flux Study*, pp. 240-281. Cambridge: Cambridge University Press.
- Geider R. J. & La Roche J., 2002. Redfield revisited: variability of C : N : P in marine microalgae and its biochemical basis. *European Journal of Phycology* 37:1-17.
- Gervais F. & Riebesell U., 2001. Effect of phosphorus limitation on elemental composition and stable carbon isotope fractionation in a marine diatom growing under different CO<sub>2</sub> concentrations. *Limnology and Oceanography* 46:497-504.
- Giordano M., Beardall J. & Raven J. A., 2005. CO<sub>2</sub> concentrating mechanisms in algae: mechanisms, environmental modulation, and evolution. *Annual Review of Plant Biology* 56:99-131.
- Gorbunov M. Y., Kolber Z. S. & Falkowski P. G., 1999. Measuring photosynthetic parameters in individual algal cells by Fast Repetition Rate fluorometry. *Photosynthesis Research* 62:141-153.
- Grasshoff K., Kremling K. & Ehrhardt M. (Eds.), 1999. *Methods of seawater analysis*, 632 p. Weinheim: Wiley VCH Verlag.
- Hansen J. L. S., Kiørboe T. & Alldredge A. L., 1996. Marine snow derived from abandoned larvacean houses: sinking rates, particle content and mechanisms of aggregate formation. *Marine Ecology Progress Series* 141:205-215.
- Hardy R. F. W., Burns R. L. & Holsten R. D., 1973. Applications of the acetylene-reduction assay for measurement of nitrogen fixation. *Soil Biology and Biochemistry* 5:47-81.
- Hedges J. I. & Oades J. M., 1997. Comparative organic geochemistries of soils and marine sediments. *Organic Geochemistry* 27:319-361.
- Honjo S., 1996. Fluxes of particles to the interior of the open oceans. In: Ittekkot V., Schäfer P., Honjo S. & Depetris P. J. (Eds.), *Particle flux in the ocean, SCOPE vol. 57*, pp. 91-154. New York: Wiley.
- Hutchins D. A., Fu F.-X., Zhang Y., Warner M. E., Feng Y., Portune K., Bernhardt P. W. & Mulholland M. R., 2007. CO<sub>2</sub> control of *Trichodesmium* N<sub>2</sub> fixation, photosynthesis, growth rates, and elemental ratios: implications for past, present, and future ocean biogeochemistry. *Limnology and Oceanography* 52:1293-1304.
- Ittekkot V. & Haake B., 1990. The terrestrial link in the removal of organic carbon. In: Ittekkot V., Kempe S., Michaelis M. & Spitz A. (Eds.), *Facets of modern biogeochemistry*, pp. 319-325. Berlin: Springer.

## Part 3: Measurements of CO<sub>2</sub> - sensitive processes

- Klaas C. & Archer D. E., 2002. Association of sinking organic matter with various types of mineral ballast in the deep sea: implications for the rain ratio. *Global Biogeochemical Cycles* 16, doi:10.1029/2001GB001765.
- Komada T., Anderson M. R. & Dorfmeier C. L., 2008. Carbonate removal from coastal sediments for the determination of organic carbon and its isotopic signatures,  $\delta^{13}\text{C}$  and  $\Delta^{14}\text{C}$ : comparison of fumigation and direct acidification by hydrochloric acid. *Limnology and Oceanography, Methods* 6:254-262.
- Kranz S. A., Sültemeyer D., Richter K. U. & Rost B., 2009. Carbon acquisition in *Trichodesmium*: diurnal variation and effect of pCO<sub>2</sub>. *Limnology and Oceanography* 54:548-559.
- Langer G., Nehrke G., Probert I., Ly J. & Ziveri P., 2009. Strain-specific responses of *Emiliania huxleyi* to changing seawater carbonate chemistry. *Biogeosciences* 6:2637-2646.
- Leonardos N. & Geider R. J., 2005. Elevated atmospheric carbon dioxide increases organic carbon fixation by *Emiliania huxleyi* (Haptophyta), under nutrient-limited high-light conditions. *Journal of Phycology* 41:1196-1203.
- Levitan O., Rosenberg G., Setlik I., Setlikova E., Grigel J., Klepetar J., Prasil O. & Berman-Frank I., 2007. Elevated CO<sub>2</sub> enhances nitrogen fixation and growth in the marine cyanobacterium *Trichodesmium*. *Global Change Biology* 13:531-538.
- Logan B. E., Passow U., Alldredge A. L., Grossart H. P. & Simon M., 1995. Rapid formation and sedimentation of large aggregates is predictable from coagulation rates (half-lives) of transparent exopolymer particles (TEP). *Deep-Sea Research II* 42:203-214.
- Mari X., 2008. Does ocean acidification induce an upward flux of marine aggregates? *Biogeosciences* 5:1023-1031.
- McCallister S. L., Bauer J. E., Cherrier J. E. & Ducklow H. W., 2004. Assessing sources and ages of organic matter supporting river and estuarine bacterial production: a multiple-isotope ( $\Delta^{14}\text{C}$ ,  $\delta^{13}\text{C}$  and  $\delta^{15}\text{N}$ ) approach. *Limnology and Oceanography* 49:1687-1702.
- Montoya J. P., Voss M., Kähler P. & Capone D. G., 1996. A simple, high-precision, high-sensitivity tracer assay for N<sub>2</sub> fixation. *Applied and Environmental Microbiology* 62:986-993.
- Morel F. M. M. & Hudson R. J., 1984. The geobiological cycle of trace elements in aquatic systems: Redfield revisited. In: Stumm W. (Ed.), *Chemical processes in lakes*, pp. 251-281. New York: Wiley.
- Mulholland M. R., 2007. The fate of nitrogen fixed by diazotrophs in the ocean. *Biogeosciences* 4:37-51.
- Mulholland M. R. & Bernhardt P. W., 2005. The effect of growth rate, phosphorus concentration, and temperature on N<sub>2</sub> fixation, carbon fixation, and nitrogen release in continuous cultures of *Trichodesmium* IMS101. *Limnology and Oceanography* 50:839-849.
- Mulholland M. R., Bernhardt P. W., Heil C. A., Bronk D. A. & O'Neil J. M., 2006. Nitrogen fixation and release of fixed nitrogen by *Trichodesmium* spp. in the Gulf of Mexico. *Limnology and Oceanography* 51:1762-1776.
- Nelson P. N., Baldock J. A., Clarke P., Oades J. M. & Churchman G. J., 1999. Dispersed clay and organic matter in soil: their nature and associations. *Australian Journal of Soil Research* 37:289-315.
- Nielsen M. V., 1995. Photosynthetic characteristics of the coccolithophorid *Emiliania huxleyi* (Prymnesiophyceae) exposed to elevated concentrations of dissolved inorganic carbon. *Journal of Phycology* 31:715-719.
- Paasche E. & Brubak S., 1994. Enhanced calcification in the coccolithophorid *Emiliania huxleyi* (Haptophyceae) under phosphorus limitation. *Phycologia* 33:324-330.
- Passow U., 2002. Transparent exopolymer particles (TEP) in aquatic environments. *Progress in Oceanography* 55:287-333.
- Paulino A. I., Egge J. K. & Larsen A., 2008. Effects of increased atmospheric CO<sub>2</sub> on small and intermediate sized osmotrophs during a nutrient induced phytoplankton bloom. *Biogeosciences* 5:739-748.
- Peltier G. & Thibault P., 1985. O<sub>2</sub> uptake in the light in *Clamydomonas* - evidence for persistent mitochondrial respiration. *Plant Physiology* 79:225-230.
- Peterson B. J. & Fry B., 1987. Stable isotopes in ecosystem studies. *Annual Review of Ecology and Systematics* 18:293-320.



- Peterson M. L., Hernes P. J., Thoreson D. S., Hedges J. I., Lee C. & Wakeham S. G., 1993. Field evaluation of a valved sediment trap. *Limnology and Oceanography* 38:1741-1761.
- Peterson M. L., Wakeham S. G., Lee C., Askea M. A. & Miquel J. C., 2005. Novel techniques for collection of sinking particles in the ocean and determining their settling rates. *Limnology and Oceanography, Methods* 3:520-532.
- Raven J. A. & Falkowski P. G., 1999. Oceanic sinks for atmospheric CO<sub>2</sub>. *Plant Cell and Environment* 22:741-755.
- Raven J. A., 1990. Use of isotopes in estimating respiration and photorespiration in microalgae. *Marine Microbial Food Webs* 4:59-86.
- Redfield A. C., Ketchum B. H. & Richards F. A., 1963. The influence of organisms on the composition of seawater. In: Hill M. N. (Ed.), *The sea*, pp. 26-77. New York: Wiley.
- Riebesell U., Schulz K. G., Bellerby R. G. J., Botros M., Fritsche P., Meyerhöfer M., Neill C., Nondal G., Oschlies A., Wohlers J. & Zöllner E., 2007. Enhanced biological carbon consumption in a high CO<sub>2</sub> ocean. *Nature* 450:545-549.
- Riley G. A., 1970. Particulate organic matter in sea water. *Advances in Marine Biology* 8:1-118.
- Rost B., Kranz S. A., Richter K. U. & Tortell P. D., 2007. Isotope disequilibrium and mass spectrometric studies of inorganic carbon acquisition by phytoplankton. *Limnology and Oceanography, Methods* 5:328-337.
- Rost B., Riebesell U., Burkhardt S. & Sültemeyer D., 2003. Carbon acquisition of bloom-forming marine phytoplankton. *Limnology and Oceanography* 48:55-67.
- Rost B., Zondervan I. & Wolf-Gladrow D., 2008. Sensitivity of phytoplankton to future changes in ocean carbonate chemistry: current knowledge, contradictions and research directions. *Marine Ecology Progress Series* 373:227-237.
- Sabine C. L., Feely R. A., Gruber N., Key R. M., Lee K., Bullister J. L., Wanninkhof R., Wong C. S., Wallace D. W. R., Tilbrook B., Millero F. J., Peng T. H., Kozyr A., Ono T. & Rios A. F., 2004. The oceanic sink for anthropogenic CO<sub>2</sub>. *Science* 305:367-371.
- Savoye N., Benitez-Nelson C., Burd A. B., Cochran J. K., Charette M., Buesseler K. O., Jackson G. A., Roy-Barman M., Schmidt S. & Elskens M., 2006. <sup>234</sup>Th sorption and export models in the water column: a review. *Marine Chemistry* 100:234-249.
- Schartau M., Engel A., Schröter J., Thoms S., Völker C. & Wolf-Gladrow D., 2007. Modelling carbon overconsumption and the formation of extracellular particulate organic carbon. *Biogeosciences* 4:433-454.
- Steeman Nielsen E., 1951. Measurement of the production of organic matter in the sea by means of carbon-14. *Nature* 167:684-685.
- Sterner R. W., Andersen T., Elser J. J., Hessen D. O., Hood J. M., McCauley E. & Urabe J., 2008. Scale-dependent carbon : nitrogen : phosphorus seston stoichiometry in marine and freshwaters. *Limnology and Oceanography* 53:1169-1180.
- Stoll M. H. C., Bakker K., Nobbe G. H. & Haese R. R., 2001. Continuous-flow analysis of dissolved inorganic carbon content in seawater. *Analytical Chemistry* 73:4111-4116.
- Suggett D. J., Oxborough K., Baker N. R., MacIntyre H. L., Kana T. M. & Geider R. J., 2003. Fast repetition rate and pulse amplitude modulation chlorophyll *a* fluorescence measurements for assessment of photosynthetic electron transport in marine phytoplankton. *European Journal of Phycology* 38:371-384.
- Thingstad T. F., Bellerby R. G. J., Bratbak G., Børsheim K. Y., Egge J. K., Heldal M., Larsen A., Neill C., Nejstgaard J., Norland S., Sandaa R. A., Skjoldal E. F., Tanaka T., Thyrraug R. & Töpper B., 2008. Counterintuitive carbon-to-nutrient coupling in an Arctic pelagic ecosystem. *Nature* 455:387-390.
- Tortell P. D., Payne C. D., Li Y. Y., Trimborn S., Rost B., Smith W. O., Riesselman C., Dunbar R. B., Sedwick P. & DiTullio G. R., 2008. CO<sub>2</sub> sensitivity of Southern Ocean phytoplankton. *Geophysical Research Letters* 35, L04605. doi:10.1029/2007GL032583.

- Trimborn S., Lundholm N., Thoms S., Richter K.-U., Krock B., Hansen P. J. & Rost B., 2008. Inorganic carbon acquisition in potentially toxic and non-toxic diatoms: the effect of pH-induced changes in seawater carbonate chemistry. *Physiologia Plantarum* 133:92-105.
- Turnewitsch R., Springer B. M., Kiriakoulakis K., Vilas J. C., Aristegui J., Wolff G., Peine F., Werk S., Graf G. & Waniek J. J., 2007. Determination of particulate organic carbon (POC) in seawater: the relative methodological importance of artificial gains and losses in two glass-fiber-filter-based techniques. *Marine Chemistry* 105:208-228.
- Valdes J. R. & Price J. F., 2000. A neutrally buoyant, upper ocean sediment trap. *Journal of Atmospheric and Oceanic Technology* 17:62-68.
- Verdugo P., Alldredge A. L., Azam F., Kirchman D. L., Passow U. & Santschi P. H., 2004. The oceanic gel phase: a bridge in the DOM-POM continuum. *Marine Chemistry* 92:67-85.
- Veuger B., Eyre B. D., Maher D. & Middelburg J. J., 2007. Nitrogen incorporation and retention by bacteria, algae, and fauna in a subtropical intertidal sediment: an in situ <sup>15</sup>N-labeling study. *Limnology and Oceanography* 52:1930-1942.
- Volk T. & Hoffert M. I., 1985. Ocean carbon pumps: analysis of relative strengths and efficiencies in ocean driven CO<sub>2</sub> changes. In: Sundquist E. T. & Broecker W. S. (Eds.), *The carbon cycle and atmospheric CO<sub>2</sub>: natural variations Archean to present*, pp. 99-110. Washington, D.C.: American Geophysical Union.
- Williams P. J. le B. & Robertson J. E., 1991. Overall planktonic oxygen and carbon dioxide metabolisms: the problem of reconciling observations and calculations of photosynthetic quotients. *Journal of Plankton Research* 13:153-169.
- Winkler L. W., 1888. Die Bestimmung des in Wasser Gelösten Sauerstoffes. *Berichte der Deutschen Chemischen Gesellschaft* 21:2843-2855.
- Yu E. F., Francois R., Bacon M. P., Honjo S., Fleer A. P., Manganini S. J., Rutgers van der Loeff M. M & Ittekkot V., 2001. Trapping efficiency of bottom-tethered sediment traps estimated from the intercepted fluxes of <sup>230</sup>Th and <sup>231</sup>Pa. *Deep-Sea Research I* 48:865-889.

## 12 Direct measurements of calcification rates in planktonic organisms

Victoria J. Fabry<sup>1</sup> and William M. Balch<sup>2</sup>

<sup>1</sup>California State University San Marcos, USA

<sup>2</sup>Bigelow Laboratory for Ocean Sciences, USA

### 12.1 Introduction

The secretion of calcium carbonate (CaCO<sub>3</sub>) skeletal structures is widespread across planktonic biota throughout the world oceans. The principal planktonic groups that secrete CaCO<sub>3</sub> are the coccolithophores, foraminifers and thecosomatous pteropods (Figure 12.1). In addition, many benthic invertebrates produce planktonic larval stages that calcify, including echinoderms and molluscs. Most planktonic organisms investigated to date exhibit reduced or abnormal calcification in response to elevated p(CO<sub>2</sub>) and the concomitant changes in seawater chemistry that occur with rising ocean acidity (Spero *et al.*, 1997; Bijma *et al.*, 1999, 2002; Riebesell *et al.*, 2000; Zondervan *et al.*, 2002; Sciandra *et al.*, 2003; Kurihara & Shirayama, 2004; Russell *et al.*, 2004; Delille *et al.*, 2005; Engel *et al.*, 2005; Orr *et al.*, 2005; Kurihara *et al.*, 2007, 2008; Dupont *et al.*, 2008). However, other studies with planktonic calcifiers have reported either no change or increased calcification under high p(CO<sub>2</sub>) conditions (Langer *et al.*, 2006; Iglesias-Rodriguez *et al.*, 2008; Wood *et al.*, 2008; McDonald *et al.*, 2009; Miller *et al.*, 2009). In some cases, the observed enhanced or compensatory calcification is accompanied by physiological trade-offs such as decreased growth rates (Iglesias-Rodriguez *et al.*, 2008), poor musculature (Wood *et al.*, 2008), and weakened calcareous shells (McDonald *et al.*, 2009) that likely would reduce ecological fitness or become fatal in field populations. Other work suggests that biota which live in highly variable habitats such as estuaries may be more tolerant of elevated p(CO<sub>2</sub>) conditions (Miller *et al.*, 2009). Thus, calcification is a key physiological process to measure in studies of the biological and ecological impacts of ocean acidification. Moreover, direct measurements of calcification rates in the field can be used to provide critical baseline information from which to detect changes that may occur with progressive ocean acidification. Here, we discuss the most commonly used methods to directly measure calcification rates in planktonic organisms and evaluate some of the advantages and disadvantages of each approach.

### 12.2 Approaches and methodologies

#### 12.2.1 Biological samples and experimental design

Many coccolithophores and larvae of benthic molluscs, echinoderms, crustaceans and other invertebrates can be cultured readily in the laboratory. Such species enable the investigation of chronic exposure to high p(CO<sub>2</sub>) over successive generations.

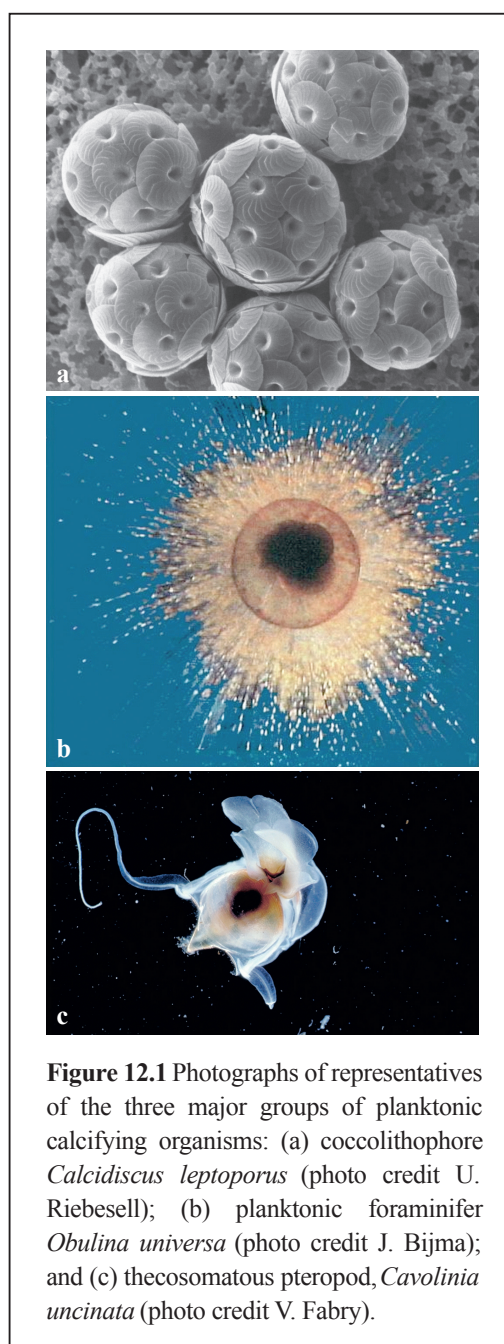

**Figure 12.1** Photographs of representatives of the three major groups of planktonic calcifying organisms: (a) coccolithophore *Calcidiscus leptoporus* (photo credit U. Riebesell); (b) planktonic foraminifer *Obulina universa* (photo credit J. Bijma); and (c) thecosomatous pteropod, *Cavolinia uncinata* (photo credit V. Fabry).

The genetic diversity of the population used in experiments should be considered in the experimental design and interpretation of results, as such genetic variability would likely affect the response pattern and resiliency of populations. In the commonly cultured coccolithophore, *Emiliana huxleyi* (Langer *et al.*, 2009), for example, various strains respond differently to changes in the seawater inorganic carbon system. Evidence suggests that this cosmopolitan species is composed of many varieties with genetically and morphologically distinct properties (Iglesias-Rodriguez *et al.*, 2006; Cubillos *et al.*, 2007).

Planktonic foraminifers and thecosomatous pteropods thus far have not been maintained in the laboratory for multiple generations. However, experiments on individuals at a variety of life stages have been successful with the use of careful collection methods.

These major groups of planktonic calcifiers are easily damaged when collected by plankton nets. Hand-collection by scuba divers provides undamaged foraminifers and pteropods, and is preferable to the use of plankton nets. Alternatively, if pteropods are very abundant in surface waters, they can be gently scooped up with beakers or other wide-mouth containers (Figure 12.2). Culture methods for planktonic foraminifers have been devised which allow these protists to be kept in the laboratory from the time of their capture until gametogenesis occurs (Spero & Williams, 1988; Lea *et al.*, 1999). Keeping individual foraminifers and pteropods in separate containers or at very low densities in particle-free seawater minimises the chance that organisms will stick together, and, in the case of pteropods, will reduce the accumulation of mucus.

In manipulative experiments with planktonic calcifiers, the duration of any acclimatisation period to perturbation and control treatments necessarily will depend on how long the organism can be kept in captivity. While coccolithophore cultures and larvae of many benthic invertebrates may be maintained for long acclimation periods, experimental treatment conditions as well as possible differential changes in the organisms themselves during the acclimatisation period should be monitored. Design of manipulative experiments should include replication at an appropriate scale that matches the experimental units (see chapter 4 of this volume). Pseudoreplication, in which a single experimental unit is subsampled rather than replicated, makes it impossible to distinguish sampling variation from a real treatment effect (Hurlbert, 1984; Quinn & Keough, 2002), and should be avoided.

### 12.2.2 Isotope methods

Isotope tracers are commonly used to directly measure calcification rates in planktonic taxa. Generally, these methods involve the addition of a small volume of radioactive <sup>14</sup>C (as NaH<sup>14</sup>CO<sub>3</sub>) or <sup>45</sup>Ca (as <sup>45</sup>CaCl<sub>2</sub>) or a stable isotope such as <sup>48</sup>Ca in samples that are incubated, and the subsequent incorporation of the isotope into biogenic CaCO<sub>3</sub> is quantified. This approach provides a measure of net calcification during the incubation period. Isotope methods, particularly those with radioisotopes, are highly sensitive and, if used appropriately, are able to measure low rates of calcification. This allows short incubation times, which is a distinct advantage when using organisms that cannot be maintained long in culture or over successive generations.

Calcification rates of coccolithophores in cultures, mesocosms and field populations have been reported using <sup>14</sup>C uptake methods (e.g. Paasche, 1964; Fernández *et al.*, 1994; Paasche & Brubak, 1994; Balch & Kilpatrick, 1996; Paasche *et al.*, 1996; Poulton *et al.*, 2007), and less frequently using <sup>45</sup>Ca uptake (e.g. van der Wal *et al.*,

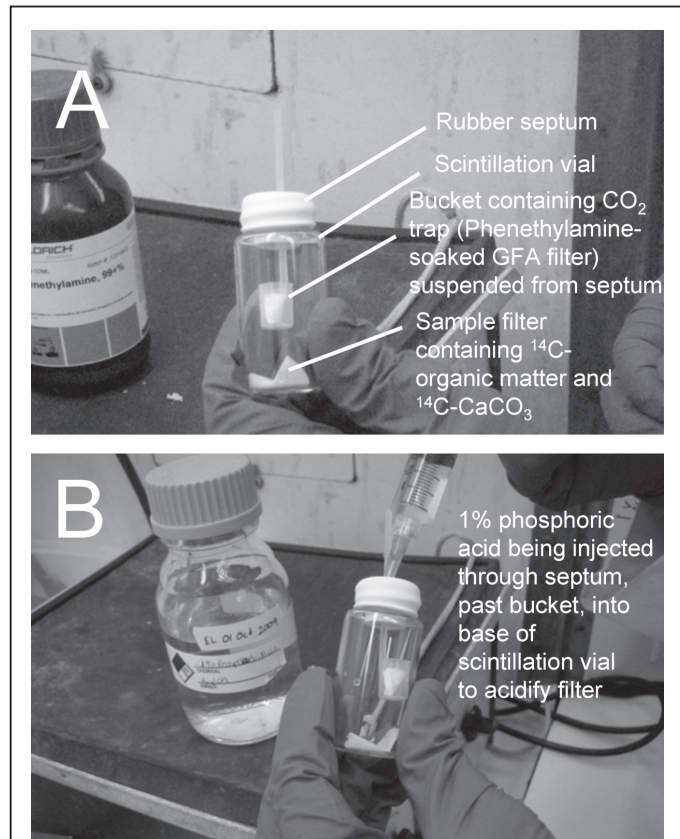

**Figure 12.2** In the cold waters of the Ross Sea near Antarctica, a researcher wearing chest-waders uses a plastic beaker attached to a long pole to carefully hand-collect planktonic pteropods (photo credit: V. Fabry).

1987, 1994). Generally,  $^{14}\text{C}$  is easier to use than  $^{45}\text{Ca}$  in coccolithophore calcification rate experiments because the unincorporated isotope is more readily rinsed from samples than is  $^{45}\text{Ca}$ . One common approach is to filter (and carefully rinse) two samples that have been incubated with  $^{14}\text{C}$ , fume one filter with acid, and count each filter for  $^{14}\text{C}$  activity. The fumed filter provides the photosynthetic fixation of  $^{14}\text{C}$ , while the difference between the two filters is the acid-labile component of  $^{14}\text{C}$  fixation, which is assumed to be calcification. The problem with this approach, however, is that calcification is calculated as the small difference between two large numbers, each with significant error. These errors then compound.

The microdiffusion method of Paasche & Brubak (1994) is an elegant protocol that enables the direct measurement of  $^{14}\text{C}$  fixation into photosynthate as well as coccolith calcite in the same sample. Briefly, this method entails filtration and rinsing of the incubated sample onto a polycarbonate filter. The filter is placed on the side of a scintillation vial, a small volume of 1% phosphoric acid is pipetted to the bottom of the vial, and a small GF/F filter containing a  $\text{CO}_2$ -absorbant is placed on the inside of the cap of the vial. The vial is placed on its side and rotated such that the acid covers the polycarbonate filter, dissolving any labeled particulate inorganic carbon, and the resultant  $^{14}\text{CO}_2$  is absorbed onto the GF/F filter. The cap with the GF/F filter is transferred to a new scintillation vial and both filters are then counted for  $^{14}\text{C}$  activity. Routine checks with filter efficiency tests and total isotope recovery tests (Paasche & Brubak, 1994) are critical to ensure proper application of this method. Incubation times of experiments that have used radioisotopes in coccolithophores range from minutes to 24 hours. The method has been adapted further for work on ships by Balch *et al.* (2000) (Figure 12.3).

There are few direct measurements of calcification rates in planktonic foraminifers. Methods involving the addition of  $^{14}\text{C}$  (Erez, 1983),  $^{45}\text{Ca}$  (Anderson & Faber, 1984) and the stable isotope  $^{48}\text{Ca}$  (Lea *et al.*, 1995) have been described. Most of these studies used diver-collected specimens of symbiont-bearing foraminifers to provide undamaged individuals for experiments. Foraminifers collected in short plankton tows have also been used in experiments, however (Erez, 1983), and these individuals may require a longer recovery time prior to experimentation than those collected by scuba divers. Foraminifers collected in the field were grown in laboratory



**Figure 12.3** Sample manipulations involved in the microdiffusion technique for measuring phytoplankton calcification and primary productivity (Paasche & Brubak, 1994; Balch *et al.*, 2000). (A) Basic set-up showing scintillation vial with filter (which contains  $^{14}\text{C}$ -labeled particulate organic matter and  $^{14}\text{C}\text{-CaCO}_3$ ) in the bottom. The vial is sealed with a rubber septum from which is suspended a plastic bucket containing a GFA filter soaked with 0.2 ml of phenethylamine (to act as a  $\text{CO}_2$  trap). (B) Separation of  $^{14}\text{C}$ -labeled POC and PIC begins when a syringe is used to inject 1.0 ml of 1% phosphoric acid, past the bucket/trap onto the filter in the bottom of the vial. The acid drives the  $^{14}\text{C}\text{-CaCO}_3$  into the head space as  $^{14}\text{C}\text{-CO}_2$  where it is subsequently trapped in the phenethylamine trap over the next 24 h. Following the diffusion process, the vial is opened and the bucket (containing activity originally associated with  $^{14}\text{C}\text{-CaCO}_3$ ) is placed in a separate vial with 1 ml distilled water plus 10 ml scintillation cocktail. The original vial with filter (containing  $^{14}\text{C}$ -organic matter) and 1 ml acid has 10 ml of scintillation cocktail added. Both vials are then placed in a high sensitivity scintillation counter for measurement of their respective radioactivity.

culture under various temperature and light conditions, periodically fed, and maintained for up to 10 days until gametogenesis occurred. Anderson & Faber (1984) suggested that the presence of an internal pool of calcium in the foraminifer *Globigerinoides sacculifer* resulted in a lag time of  $\geq 24$  h in equilibration of shell CaCO<sub>3</sub> with ambient seawater <sup>45</sup>Ca. Consequently, these researchers recommended that incubation times be at least 24 h to avoid underestimation of calcification rates. Bentov & Erez (2005) reported the existence of cytoplasmic granules that may provide temporary storage sites for calcium prior to CaCO<sub>3</sub> secretion. Lea *et al.* (1995) measured calcification rates of *Orbulina universa* using <sup>48</sup>Ca in experiments with incubation periods ranging from 6 to 72 h and found no evidence of a lag time over the incubation times investigated. These researchers concluded that the cytoplasmic pool of calcium equilibrates with seawater Ca<sup>2+</sup> within 6 h, enabling the measurement of reliable calcification rates over incubation periods of 6 h or longer. Researchers using isotope tracers to measure calcification rates or trace element composition of the calcite tests of planktonic foraminifers have developed shell cleaning protocols, which are used after the termination of experiments, to digest cytoplasm with bleach or other base solutions (e.g. Anderson & Faber, 1984; Lea *et al.*, 1995; Russell *et al.*, 2004). Because individual foraminifers can be removed from the isotope-inoculated seawater and rinsed well without the use of filtration, the problem of potential retention of unfixed isotope on filters can be avoided. Care must be taken when cleaning lightly calcified juveniles to not dissolve CaCO<sub>3</sub>, thereby underestimating calcification rates.

Calcification rates in diver-collected, thecosomatous pteropods and heteropods have been measured by <sup>45</sup>Ca uptake experiments (Fabry, 1989, 1990; Fabry *et al.*, 2008). Because pteropods do not produce their mucous feeding webs in typical experimental vessels, only short-term experiments with these fragile animals have thus far been successful. During such experiments, pteropods and heteropods can be observed to swim normally. In processing samples, the shell sample must be separated from the animal tissue prior to scintillation counting. This can be done by drying the specimen, dissolving the shell, and quantitatively rinsing the tissue before removing it from the dissolved shell solution. Use of filters is not necessary. As with foraminifers, additional studies investigating the residence time of possible internal Ca<sup>2+</sup> pools in calcifying pteropods and heteropods would be helpful in choosing the duration of experimental incubations using calcium isotopes as well as in the interpretation of data.

Calcification rates derived from addition of isotope tracers must be corrected for the passive exchange of the isotope with stable calcium or carbon in the biogenic CaCO<sub>3</sub>. Typically, blanks consist of samples killed with buffered formalin, ethanol or other poison, or cleaned empty shells or tests that are incubated for the same experimental times and under similar conditions as treatment organisms. The non-biological uptake of isotope in the CaCO<sub>3</sub> sample occurs through adsorption onto CaCO<sub>3</sub> surfaces and through the process of exchange between the isotopic composition of the shell with that of the ambient seawater. The time for the exchange process to reach near-equilibrium will depend on many different factors, including the reactive surface area of the biogenic CaCO<sub>3</sub> (and any changes that may occur during the incubation time) and the amount of tracer isotope added relative to the naturally occurring isotope. Thus, time zero blanks are highly variable (Balch, unpubl. data; Fabry, unpubl. data) and are generally not recommended in calcification rate measurements. Because blank values must be subtracted from measured calcification rates and thus the blank can significantly affect values of net calcification rates, careful consideration should be given to the choice of an appropriate blank.

In coccolithophore experiments using <sup>14</sup>C, formalin-killed blanks are most commonly used. Paasche (1962) reported that such blanks corresponded to less than 1% of the calcification in living cells under conditions of maximum photosynthesis. Further, Paasche (1963) found that the non-biological isotope exchange as measured by formalin-killed samples accounted for 0.5 to 4% of the coccolith calcification at light-saturated photosynthesis, and this blank was consistently higher in artificial medium than in natural seawater. This finding supports the notion that the chemistry of CaCO<sub>3</sub> surfaces is complex and that formalin may alter the reactive surfaces of biogenic carbonates at least under some conditions. Nevertheless, formalin-killed blanks generally provide reproducible estimates of passive exchange of <sup>14</sup>C onto calcite coccoliths. Under conditions of reduced light, low coccolithophore abundance, or other factors that can result in low values of coccolithophore calcification rates, care must be taken when processing both blank and treatment filters, owing to the reduced sample signal to background ratio.

The few direct measurements of foraminiferal calcification rates using isotope tracers have included rigorous procedures to clean the calcite tests (Anderson & Faber, 1984; Lea *et al.*, 1995).  $^{45}\text{Ca}$  uptake experiments with shelled pteropods and heteropods have used blanks consisting of animals killed with buffered formalin or ethanol and incubated for the same time periods as treatments (e.g. Fabry, 1989, 1990; Fabry *et al.*, 2008). Because calcification rates can be low in planktonic heterotrophs, particularly during short-term experiments, the correction for non-biological uptake of isotope is critical. For all organisms, we recommend that experiments investigating the efficacy of the blank protocol be conducted prior to the measurement of net calcification rates.

Calcification rates determined with isotopes typically are recorded as mass or moles of C or  $\text{CaCO}_3$  per cell or individual organism per unit time (e.g.  $\text{pg C cell}^{-1} \text{d}^{-1}$  or  $\mu\text{mol CaCO}_3 \text{ individual}^{-1} \text{h}^{-1}$ ). Isotope-derived calcification rates have been normalised to chlorophyll in coccolithophores and shell mass in foraminifers, pteropods and heteropods. In pteropods, regressions of shell weight on dry weight of animal tissue, or in some species, shell diameter, have been reported and are useful in scaling up results to field populations.

### 12.2.3 Change in mass of particulate inorganic carbon

Another approach to determine calcification rates involves measurements of the mass of particulate inorganic carbon (PIC) or, less commonly, particulate calcium over time. This method primarily has been used with coccolithophores in laboratory and mesocosm experiments, where coccolithophore calcite is thought to be the only source of  $\text{CaCO}_3$  (e.g. van Bleijswijk *et al.*, 1994; Paasche, 1999; Riebesell *et al.*, 2000; Zondervan *et al.*, 2002; Engel *et al.*, 2005; Iglesias-Rodriguez *et al.*, 2008). This method measures net calcification rates, typically in units of mass or moles of C or  $\text{CaCO}_3$  per cell or unit volume per unit time. To measure the change in PIC, duplicate samples for CHN analyses are filtered onto two filters: one filter is rinsed only and the second filter is rinsed, and subsequently fumed with acid to remove any PIC. The difference in C values of the two filters is the acid-labile carbon, which is assumed to be PIC. This mass-based method using CHN analyses is commonly used with coccolithophore laboratory cultures and is highly reproducible. For field estimates of calcification when no coccolithophore blooms are present, the technique suffers from the problem that the PIC estimate is based on the small difference between two large numbers (see above). A preferred method to estimate changing PIC when coccolithophore populations are lower than bloom densities – which is most of the time in field communities – is by directly measuring particulate calcium with atomic or graphite furnace atomic absorption or with the more sensitive method of inductively coupled plasma optical emission spectroscopy (ICPOES) (Balch *et al.*, 2008). Recent advances in estimating the standing stocks of PIC in the field include *in situ* measurements using a birefringence method (Guay & Bishop, 2002). Beaufort (2005) has used this principle on a single cell basis with microscope measurements of birefringence. This approach assumes a constant ratio of PIC to birefringence. Note, however, a limitation of the birefringent approach is that PIC is not the only birefringent material in the ocean. For example, many detrital particles and dinoflagellate thecae are birefringent. Correction for this possibility requires either calibrating the measurements to account for the presence of non-PIC birefringence, or excluding non-PIC particles from the birefringence measurement (such as in microscopy, which is quite simple to do given the unique birefringence patterns of coccolithophores).

Another way to measure the standing stock of PIC involves the use of acid-labile backscattering (Balch & Drapeau, 2004). That is, measuring the particle backscattering before and after dissolution of PIC (by dropping the pH below the dissociation point for calcite for 30 s prior to measuring). Potential limitations of this approach are: (1) that the scattering properties of non-PIC particles do not change with the change in pH and (2) a constant backscattering cross-section ( $b_b^*$ ;  $\text{m}^2 (\text{mol PIC})^{-1}$ ) can be applied to all coccoliths to relate PIC backscattering to PIC concentration. Both assumptions have been tested in the laboratory and in the field, and the technique can be quantitatively calibrated to PIC. The use of algorithms with satellite data provides estimates of coccolithophore PIC on basin-scales (Gordon *et al.*, 2001; Balch *et al.*, 2005, 2007), which when monitored over time, can assess large-scale changes in the surface ocean coccolithophore PIC mass and its large-scale distributions. This approach will not work through clouds, obviously; the quality of the PIC estimate will be directly related to the quality of the atmospheric correction of the scenes. It has the same assumption of one value for the  $b_b^*$  of all PIC coccoliths. The variability of this has been measured previously (Balch *et al.*, 1999).

Shell growth in planktonic foraminifers under various conditions in laboratory experiments has been investigated using changes in test mass, diameter, and shell wall thickness over time periods up to 10 days (e.g. Spero & Lea, 1993; Bijma *et al.*, 1999, 2002; Erez, 2003; Russell *et al.*, 2004). During laboratory culture, the planktonic foraminifers *Orbulina universa* and *Globigerinoides sacculifer* add shell chambers in distinct events, with *O. universa* secreting a large, terminal spherical chamber. Thus, if juvenile foraminifers are collected and grown until gametogenesis occurs, the majority of the shell CaCO<sub>3</sub> will be secreted during the laboratory culture period. For these cultured species, the individual test chambers are large enough to be carefully dissected and weighed (e.g. Spero & Lea, 1993; Lea *et al.*, 1995).

This approach to estimating calcification rates could be used in other planktonic heterotrophs such as the larvae of benthic molluscs and diverse calcifying invertebrates, particularly when larvae can be obtained in high numbers, (e.g. from aquaculture facilities) and organisms can be maintained well under laboratory conditions. For optimal use, the change in PIC over an experimental time period should be readily measurable and distinguishable from the change in particulate organic carbon.

### 12.2.4 Visual measurements of CaCO<sub>3</sub> growth

Visual documentation of the change in dimensions of CaCO<sub>3</sub> skeletal structures is another approach that has been used to estimate calcification rates in coccolithophores (Paasche *et al.*, 1996), thecosomatous pteropods (Redfield, 1939; Kobayashi, 1974; Wells, 1976), and the larvae of oysters (Miller *et al.*, 2009) and barnacles (McDonald *et al.*, 2009). While microscope techniques can accurately measure coccolith or shell dimensions, the calcium content of the CaCO<sub>3</sub> skeletal structure must be known and should vary little within a treatment. These two requirements may not be valid in many groups such as coccolithophores, foraminifers, and pteropods in which the thickness of their CaCO<sub>3</sub> structures can vary. Quantification of calcification rates with this approach should, therefore, include an independent measure of calcium concentration and its variability within the shell size ranges of interest. This method has been used primarily with coccolithophores in laboratory and mesocosm experiments. Use of this method with field populations of heterotrophic calcifiers is limited to regions where the same population can be sampled repeatedly over time. Several studies relating to the effects of ocean acidification on both holoplanktonic and meroplanktonic calcifying organisms have produced stunning visual documentation of the calcification response to increased seawater p(CO<sub>2</sub>) (e.g. Riebesell *et al.*, 2000; Kurihara & Shirayama, 2004; Orr *et al.*, 2005; Langer *et al.*, 2006; Kurihara *et al.*, 2007, 2008; Dupont *et al.*, 2008), although differences in calcification rates among the experimental treatments and controls are not always quantified.

### 12.3 Strengths and weaknesses

The major strength of studies that directly measure calcification rates in planktonic biota is that they provide quantitative estimates ( $\pm$  standard deviation) that are useful to many research questions such as determining regional baselines and assessing changes in calcification over time, across locations and species, and under different environmental conditions. Such empirical data can be used in models ranging from the scale of the organism to ecosystem processes. Moreover, manipulative experiments can isolate and highly control environmental variables in well-designed experiments to quantify impacts on calcification rates. Multifactorial experiments are valuable in testing the possible interaction of variables such as increased seawater p(CO<sub>2</sub>) and temperature (e.g. Feng *et al.*, 2008).

In ocean acidification research, calcification rate measurements can be made under conditions in which the parameters of the inorganic carbon system in seawater are well defined and tightly controlled. Two or more parameters of the inorganic carbon system should be measured at least at the beginning and end of incubation times, and more frequent measurements or continuous monitoring is often preferable.

The greatest disadvantage of the approaches described here is the degree to which containment of the experimental organisms causes divergence of measured calcification rates from those in the natural environment. While bottle effects can cause stress to the organism, experimentally determined calcification rates can be combined with other physiological measurements such as respiration rates to estimate the magnitude of this effect. Incubation



times should be chosen to optimise the trade-off between longer acclimation periods and adverse bottle effects on the organism. Short incubation times, such as those made possible with the use of isotope tracers, minimise bottle effects. In heterotrophs, direct measurements of calcification rates coupled with those relating to other processes affecting growth, reproduction, oxygen consumption or acid-base balance can provide an assessment of the response of the entire organism to particular stressors, such as high CO<sub>2</sub>, as well as the impact of the organism's respiration on the CO<sub>2</sub> burden (hence acidification) in the experimental vessel.

Most manipulative experiments investigating the impacts of ocean acidification on calcification have been conducted in short-term incubations, which do not provide information on the organism's response to chronic exposure to elevated p(CO<sub>2</sub>) over multiple generations. For fragile species, however, only short-term experiments currently are possible. Such experiments remain an important tool in assessing the comparative sensitivity of different taxa and functional groups to projected changes in ocean CO<sub>2</sub> chemistry. Rigorous control of experimental conditions and sufficient replication at the level of treatment for statistical power allow specific hypotheses to be tested, generating predictions that can be examined in larger scale manipulative experiments or with natural gradients in the field (see chapter 8). Moreover, the sensitivity of isotope methods can be exploited to investigate the mechanistic pathways and kinetics of calcification (Paasche, 2001; Erez, 2003).

The most commonly used techniques to measure rates of planktonic calcification provide estimates of net calcification rates. Dissolution of biogenic CaCO<sub>3</sub> is likely occurring at the same time, and may be particularly important in ocean acidification studies (e.g. Orr *et al.*, 2005; Green *et al.*, 2009; McDonald *et al.*, 2009), but dissolution rates are rarely measured independently in laboratory, mesocosm or field studies of calcification. Some strengths and weaknesses of methods to directly measure calcification rates are listed in Table 12.1.

**Table 12.1** Estimates of the strengths and weaknesses of commonly used approaches to directly measure calcification rates in planktonic organisms. Plus symbols (+) indicate strengths and minus signs (–) indicate weaknesses.

Strengths & weaknesses	Isotope tracers	Change in PIC	Visual measurements of CaCO <sub>3</sub> growth
Short-term incubations possible	++++	+	+
Control over environmental conditions	++++	++++	++++
Replication at appropriate scale	++++	++++	++++
High quality measurements of seawater inorganic C system possible	++++	++++	++++
Effects on individuals	++++	+++	+++
Effects on populations	+++	+++	++
Synoptic regional effects	+/-	+++	+/-
Ease of use	++	++++	+++
Labour intensive	+++	+	+++

### 12.4 Potential pitfalls

Direct measurements of calcification rates in planktonic organisms provide quantitative data under experimentally controlled conditions and can be used to assess the response of diverse calcifiers to ocean acidification. Experimental design and methods should consider potential pitfalls including:

- calcification rates may vary with age and size of the organism;
- CaCO<sub>3</sub> dissolution may be occurring simultaneously with calcification;
- grazers in incubation vessels may consume calcifying biota and/or dissolve CaCO<sub>3</sub>;
- for isotope methods, lack of fastidious attention in processing blanks and experimental samples may cause reduced sensitivity, or worse, erroneous results;
- containment or bottle effects on organisms may result in underestimates of calcification rates;
- short-term experiments may not reflect long-term response to ocean acidification;
- leaching from experimental vessels (e.g. some types of glass) may alter total alkalinity of seawater; and
- scaling up from individual responses to regional ecosystems may be difficult, although optical techniques (*in situ* birefringence, acid-labile backscattering or satellite remote sensing) can provide estimates of coccolithophore PIC concentrations over large length scales in the ocean.

### 12.5 Suggestions for improvement

Intercomparison studies of different methods to directly measure calcification rates are needed for the major groups of planktonic calcifying organisms. For isotope tracer methods, blanks are critical to establish a true zero. Therefore, investigators should include rigorous testing of blank protocols prior to measuring calcification rates. Because the most commonly used methods measure net calcification rates, independent measurements of dissolution rates would be particularly valuable to ocean acidification studies.

Similar to isotope-based measurements of primary productivity, incubation of samples in containers introduces the possibility of bottle effects. Such bottle effects generally lead to underestimates of calcification rates, however, the magnitude of this error is largely unknown. Supplementary observations can help offset this (e.g. enumeration of grazers in bottles, oxygen consumption measurements in heterotrophs), but add substantially to the cost and work plan of the project. Ideally, techniques will be developed that can measure calcification *in situ*. Any new methods should yield quantitative calcification rates in units of C or CaCO<sub>3</sub> per unit volume per unit time.

Because of the inherent variability in organisms' response to CO<sub>2</sub>-induced changes in seawater, it is important to reduce the error associated with measurements of the parameters of the inorganic carbon system. Thus, high quality measurements of at least two parameters of the seawater CO<sub>2</sub> system are essential. Development of accurate small-volume methods, particularly for the measurement of total alkalinity, would be helpful in some calcification rate experiments. However, the presence of high concentrations of nutrients and dissolved organic compounds in seawater (e.g. in some coastal waters, coccolithophore cultures, or algal cultures fed to heterotrophic calcifiers) may confound the interpretation of total alkalinity measurements (see chapter 1), and alternative seawater CO<sub>2</sub> system parameters should be measured in such cases. Certified reference materials should be used (<http://andrew.ucsd.edu/co2qc/>; see chapter 1, this volume) in all measurements of seawater p(CO<sub>2</sub>), total dissolved inorganic carbon, total alkalinity, and, if available, pH.

### 12.6 Data reporting

In studies that directly measure calcification rates in planktonic calcifiers, investigators should provide clear descriptions of the experimental design and protocols. Precision and accuracy in measurements of the parameters of the CO<sub>2</sub> system and associated factors (e.g. temperature, salinity, nutrient concentrations) should be reported. Other experimental conditions that may affect calcification rates in photosynthetic or heterotrophic organisms should be reported as appropriate, for example, irradiance, harvest time during the light/dark cycle,

cell density, nutrient and trace element concentrations, food availability, feeding frequency, and grazing. Studies should describe the method of collection of organisms, provide the mean size and range (and age if known) of organisms used in experiments, and report the duration of sample incubations. For manipulative experiments with different  $p(\text{CO}_2)$  treatments, any acclimation period and the conditions experienced by the organisms during that time should be described. In isotope tracer measurements of calcification rates, the blank values for each experimental treatment should be reported. Equations used for the calculation of calcification rates based on isotope measurements should be described, and all relevant information (e.g. whether an isotope discrimination factor is assumed) should be included.

## 12.7 Recommendations for standards and guidelines

1. Design experiments to maximise statistical power.
2. Replicate at the scale of the experimental treatment.
3. In choosing incubation times, optimise the trade-off between acclimation period for organisms and confounding bottle effects.
4. If possible, measure other physiological processes to assess any stress on the organism due to containment.
5. Test blank protocols prior to conducting calcification rate measurements with isotope methods.
6. In isotope tracer methods, use blanks incubated for the same experimental times and under the same conditions as treatment organisms.
7. Make high-quality measurements of the parameters of the seawater  $\text{CO}_2$  system during experimental incubations and use certified reference materials.
8. If high concentrations of nutrients and dissolved organic substances are present, use an alternative to total alkalinity measurements.
9. Measure and report other environmental conditions that may affect calcification rates.
10. Measure  $\text{CaCO}_3$  dissolution rates independently if possible.

## 12.8 References

- Anderson O. R. & Faber Jr. W. W., 1984. An estimation of calcium carbonate deposition rate in a planktonic foraminifer *Globigerinoides sacculifer* using  $^{45}\text{Ca}$  as a tracer: a recommended procedure for improved accuracy. *Journal of Foraminiferal Research* 14:303-308.
- Balch W. M. & Kilpatrick K., 1996. Calcification rates in the equatorial Pacific along 140° W. *Deep-Sea Research* 43(4-6): 971-993.
- Balch W. M. & Drapeau D. T., 2004. Backscattering by coccolithophorids and coccoliths: sample preparation, measurement and analysis protocols. In: Mueller J. L., Fargion G. S. & McClain C. R. (Eds.), *Ocean optics protocols for satellite ocean color sensor validation, revision 5: biogeochemical and bio-optical measurements and data analysis protocols*, pp. 27-36. Greenbelt: National Aeronautical and Space administration, Goddard Space Flight Space Center.
- Balch W. M., Drapeau D. T., Bowler B. C., Booth E. S., Windecker L. A. & Ashe A., 2008. Space-time variability of carbon standing stocks and fixation rates in the Gulf of Maine, along the GNATS transect between Portland, ME, USA, and Yarmouth, Nova Scotia, Canada. *Journal of Plankton Research* 30:119-139.
- Balch W. M., Drapeau D. T., Cucci T. L., Vaillancourt R. D., Kilpatrick K. A. & Fritz J. J., 1999. Optical backscattering by calcifying algae: separating the contribution of particulate inorganic and organic carbon fractions. *Journal of Geophysical Research - Oceans* 104:1541-1558.
- Balch W. M., Drapeau D. T. & Fritz J. J., 2000. Monsoonal forcing of calcification in the Arabian Sea. *Deep-Sea Research II* 47:1301-1337.

- Balch W. M., Gordon H. R., Bowler B. C., Drapeau D. T. & Booth E. S., 2005. Calcium carbonate measurements in the surface global ocean based on Moderate-Resolution Imaging Spectroradiometer data. *Journal of Geophysical Research - Oceans* 110, C07001. doi:10.1029/2004JC002560.
- Balch W., Drapeau D., Bowler B. & Booth E., 2007. Prediction of pelagic calcification rates using satellite measurements. *Deep-Sea Research II* 54:478-495.
- Beaufort L., 2005. Weight estimates of coccoliths using the optical properties (birefringence) of calcite. *Micropaleontology* 51:289-297.
- Bentov S. & Erez J., 2005. Novel observations on biomineralization processes in foraminifera and implications for Mg/Ca ratio in the shells. *Geology* 33:841-844.
- Bijma J., Hönisch B. & Zeebe R. E., 2002. Impact of the ocean carbonate chemistry on living foraminiferal shell weight: Comment on “Carbonate ion concentration in glacial-age deep waters of the Caribbean Sea” by W. S. Broecker and E. Clark. *Geochemistry, Geophysics, Geosystems* 3, 1064. doi:10.1029/2002GC000388.
- Bijma J., Spero H. J. & Lea D. W., 1999. Reassessing foraminiferal stable isotope geochemistry: impact of the oceanic carbonate system (experimental results). In: Fischer G. & Wefer G. (Eds.), *Use of proxies in paleoceanography: examples from the South Atlantic*, pp. 489-512. Berlin: Springer-Verlag.
- Cubillos J. C., Wright S. W., Nash G., de Salas M. F., Griffiths B., Tilbrook B., Poisson A. & Hallegraeff G. M., 2007. Calcification morphotypes of the coccolithophorid *Emiliana huxleyi* in the Southern Ocean: changes in 2001 to 2006 compared to historical data. *Marine Ecology Progress Series* 348:47-54.
- Delille B., Harlay J., Zondervan I., Jacquet S., Chou L., Wollast R., Bellerby R. G. J., Frankignoulle M., Borges A. V., Riebesell U. & Gattuso J.-P., 2005. Response of primary production and calcification to changes of pCO<sub>2</sub> during experimental blooms of the coccolithophorid *Emiliana huxleyi*. *Global Biogeochemical Cycles* 19, GB2023. doi:10.129/2004GB002318.
- Dupont S., Havenhand J., Thorndyke W., Peck L. & Thorndyke M., 2008. Near-future level of CO<sub>2</sub>-driven ocean acidification radically affects larval survival and development in the brittlestar *Ophiothrix fragilis*. *Marine Ecology Progress Series* 373:285-294.
- Engel A., Zondervan I., Aerts K., Beaufort L., Benthien A., Chou L., Delille B., Gattuso J.-P., Harlay J., Heemann C., Hoffmann L., Jacquet S., Nejtgaard J., Pizay M.-D., Rochelle-Newall E., Schneider U., Terbreuggen A. & Riebesell U., 2005. Testing the direct effect of CO<sub>2</sub> concentration on a bloom the coccolithophorid *Emiliana huxleyi* in mesocosm experiments. *Limnology and Oceanography* 50:493-507.
- Erez J., 1983. Calcification rates, photosynthesis and light in planktonic foraminifera. In: Westbroek P. & de Jong E. W. (Eds.), *Biomineralisation and Biological Metal Accumulation*, pp. 307-312. Dordrecht: D. Reidel Publishing Company.
- Erez J., 2003. The source of ions for biomineralization in foraminifera and their implications for paleoceanographic proxies. In: Dove P. M., De Yoreo J. J. & Weiner S. (Eds.), *Biomineralization, Reviews in mineralogy and geochemistry*, pp. 115-149. Washington DC: Mineralogical Society of America, Geochemical Society.
- Fabry V. J., 1990. Shell growth rates of pteropod and heteropod molluscs and aragonite production in the open ocean: implications for the marine carbonate system. *Journal of Marine Research* 48:209-222.
- Fabry V. J., 1989. Aragonite production by pteropod molluscs in the subarctic Pacific. *Deep-Sea Research* 36:1735-1751.
- Fabry V. J., Seibel B. A., Feely R. A. & Orr J. C., 2008. Impacts of ocean acidification on marine fauna and ecosystem processes. *ICES Journal of Marine Science* 65:414-432.
- Feng Y., Warner M. E., Zhang Y., Sun J., Fu F. X., Rose J. M. & Hutchins D. A., 2008. Interactive effects of increased pCO<sub>2</sub>, temperature and irradiance on the marine coccolithophore *Emiliana huxleyi* (Prymnesiophyceae). *European Journal of Phycology* 43:87-98.
- Fernández E., Balch W. M., Marañón E. & Holligan P. M., 1994. High rates of lipid biosynthesis in cultured, mesocosm and coastal populations of the coccolithophore *Emiliana huxleyi*. *Marine Ecology Progress Series* 114:13-22.

- Gordon H. R., Boynton G. C., Balch W. M., Groom S. B., Harbour D. S. & Smyth T. J., 2001. Retrieval of coccolithophore calcite concentration from SeaWiFS imagery. *Geophysical Research Letters* 28:1587-1590.
- Green M. A., Waldbusser G. G., Reilly S. L., Emerson K. & O'Donnell S., 2009. Death by dissolution: sediment saturation state as a mortality factor for juvenile bivalves. *Limnology and Oceanography* 54:1037-1047.
- Guay C. K. H. & Bishop J. K. B., 2002. A rapid birefringence method for measuring suspended CaCO<sub>3</sub> concentrations in seawater. *Deep-Sea Research I* 49:197-210.
- Hurlbert S. H., 1984. Pseudoreplication and the design of ecological field experiments. *Ecological Monographs* 54:187-211.
- Iglesias-Rodriguez M. D., Halloran P. R., Rickaby R. E. M., Hall I. R., Colmenero-Hidalgo E., Gittins J. R., Green D. R. H., Tyrrell T., Gibbs S. J., von Dassow P., Rehm E., Armbrust E. V. & Boessenkool K. P., 2008. Phytoplankton calcification in a high-CO<sub>2</sub> world. *Science* 320:336-340.
- Iglesias-Rodriguez M. D., Schofield O. M., Batley J., Medlin L. K. & Hayes P. K., 2006. Intraspecific genetic diversity in the marine coccolithophore *Emiliana huxleyi* (Prymnesiophyceae): the use of microsatellite analysis in marine phytoplankton population studies. *Journal of Phycology* 42:526-536.
- Kobayashi H. A., 1974. Growth cycle and related vertical distribution of the thecosomatous pteropod *Spiratella* ("*Limacina*") *helicina* in the central Arctic Ocean. *Marine Biology* 26:295-301.
- Kurihara H., Kato S. & Ishimatsu A., 2007. Effects of increased seawater pCO<sub>2</sub> on early development of the oyster *Crassostrea gigas*. *Aquatic Biology* 1:91-98.
- Kurihara H. & Shirayama Y., 2004. Effects of increased atmospheric CO<sub>2</sub> on sea urchin early development. *Marine Ecology Progress Series* 274:161-169.
- Kurihara H., Asai T., Kato S. & Ishimatsu A., 2008. Effects of elevated pCO<sub>2</sub> on early development in the mussel *Mytilus galloprovincialis*. *Aquatic Biology* 4:225-233.
- Langer G., Geisen M., Baumann K. H., Klas J., Riebesell U., Thoms S. & Young J. R., 2006. Species-specific responses of calcifying algae to changing seawater carbonate chemistry. *Geochemistry, Geophysics, Geosystems* 7, Q09006. doi:10.1029/2005GC001227.
- Langer G., Nehrke G., Probert I., Ly J. & Ziveri P., 2009. Strain-specific responses of *Emiliana huxleyi* to changing seawater carbonate chemistry. *Biogeosciences* 6:2637-2646.
- Lea D. W., Mashiotta T. A. & Spero H. J., 1999. Controls on magnesium and strontium uptake in planktonic foraminifera determined by live culturing. *Geochimica et Cosmochimica Acta* 63:2369-2379.
- Lea D. W., Martin P. A., Chan D. A. & Spero H. J., 1995. Calcium uptake and calcification rate in the planktonic foraminifer *Orbulina universa*. *Journal of Foraminiferal Research* 25:14-23.
- McDonald M. R., McClintock J. B., Amsler C. D., Rittschof D., Angus R. A., Orihuela B. & Lutostanski K., 2009. Effects of ocean acidification over the life history of the barnacle *Amphibalanus amphitrite*. *Marine Ecology Progress Series* 385:179-187.
- Miller A. W., Reynolds A. C., Sobrino C. & Riedel G. F., 2009. Shellfish face uncertain future in high CO<sub>2</sub> world: influence of acidification on oyster larvae calcification and growth in estuaries. *PLoS ONE* 4, e5661. doi:10.1371/journal.pone.0005661#abstract0.
- Orr J. C., Fabry V. J., Aumont O., Bopp L., Doney S. C., Feely R. A., Gnanadesikan A., Gruber N., Ishida A., Joos F., Key R. M., Lindsay K., Maier-Reimer E., Matear R., Monfray P., Mouchet A., Najjar R. G., Plattner G. K., Rodgers K. B., Sabine C. L., Sarmiento J. L., Schlitzer R., Slater R. D., Totterdell I. J., Weirig M. F., Yamanaka Y. & Yool A., 2005. Anthropogenic ocean acidification over the twenty-first century and its impact on calcifying organisms. *Nature* 437:681-686.
- Paasche E., 1962. Coccolith formation. *Nature* 193:1094-1095.
- Paasche E., 1964. A tracer study of the inorganic carbon uptake during coccolith formation and photosynthesis in the coccolithophorid *Coccolithus huxleyi*. *Physiologia plantarum. Supplementum* 3:1-82.
- Paasche E. & Brubak S., 1994. Enhanced calcification in the coccolithophorid *Emiliana huxleyi* (Haptophyceae) under phosphorus limitation. *Phycologia* 33:324-330.

- Paasche E., 1963. The adaptation of the carbon-14 method for the measurement of coccolith production in *Coccolithus huxleyi*. *Physiologia Plantarum* 16:186-200.
- Paasche E., 1999. Reduced coccolith calcite production under light-limited growth: a comparative study of three clones of *Emiliania huxleyi* (Prymnesiophyceae). *Phycologia* 38:508-516.
- Paasche E., 2001. A review of the coccolithophorid *Emiliania huxleyi* (Prymnesiophyceae), with particular reference to growth, coccolith formation, and calcification-photosynthesis interactions. *Phycologia* 40:503-529.
- Paasche E., Brubak S., Skattebøl S., Young J. R. & Green J. C., 1996. Growth and calcification in the coccolithophorid *Emiliania huxleyi* (Haptophyceae) at low salinities. *Phycologia* 35:394-403.
- Poulton A. J., Moore C. M., Seeyave S., Lucas M. I., Fielding S. & Ward P., 2007. Phytoplankton community composition around the Crozet Plateau, with emphasis on diatoms and *Phaeocystis*. *Deep-Sea Research II* 54:2085-2105.
- Quinn G. P. & Keough M. J., 2002. *Experimental design and data analysis for biologists*. 556 p. Cambridge: Cambridge University Press.
- Redfield A. C., 1939. The history of a population of *Limacina retroversa* during its drift across the Gulf of Maine. *Biological Bulletin* 76:26-47.
- Riebesell U., Zondervan I., Rost B., Tortell P. D. & Morel F. M. M., 2000. Reduced calcification of marine plankton in response to increased atmospheric CO<sub>2</sub>. *Nature* 407:364-367.
- Russell A. D., Hönisch B., Spero H. J. & Lea D. W., 2004. Effects of seawater carbonate ion concentration and temperature on shell U, Mg, and Sr in cultured planktonic foraminifera. *Geochimica et Cosmochimica Acta* 68:4347-4361.
- Sciandra A., Harlay J., Lefèvre D., Lemée R., Rimmelin P., Denis M. & Gattuso J.-P., 2003. Response of coccolithophorid *Emiliania huxleyi* to elevated partial pressure of CO<sub>2</sub> under nitrogen limitation. *Marine Ecology Progress Series* 261:111-122.
- Spero H. J., Bijma J., Lea D. W. & Bemis B. E., 1997. Effect of seawater carbonate concentration on foraminiferal carbon and oxygen isotopes. *Nature* 390:497-500.
- Spero H. J. & Williams D. F., 1988. Extracting environmental information from planktonic foraminiferal δ<sup>13</sup>C data. *Nature* 335:717-719.
- Spero H. J. & Lea D. W., 1993. Intraspecific stable isotope variability in the planktic foraminifera *Globigerinoides sacculifer*: results from laboratory experiments. *Marine Micropaleontology* 22:221-234.
- Van Bleijswijk J. D. L., Kempers R. S., Veldhuis M. J. & Westbroek P., 1994. Cell and growth characteristics of types A and B of *Emiliania huxleyi* (Prymnesiophyceae) as determined by flow cytometry and chemical analyses. *Journal of Phycology* 30:230-241.
- Van der Wal P., De Vrind J. P. M., De Vrind-De Jong E. W. & Borman A. H., 1987. Incompleteness of the coccosphere as a possible stimulus for coccolith formation in *Pleurochrysis carterae* (Prymnesiophyceae). *Journal of Phycology* 23:218-221.
- Van der Wal P., Van Bleijswijk J. D. L. & Egge J. K., 1994. Primary productivity and calcification rate in blooms of the coccolithophorid *Emiliania huxleyi* (Lohmann) Hay et Mohler developing in mesocosms. *Sarsia* 79:401-408.
- Wells F. E., 1976. Growth rates of four species of euthecosomatous pteropods occurring off Barbados, West Indies. *The Nautilus* 90:114-116.
- Wood H. L., Spicer J. I. & Widdicombe S., 2008. Ocean acidification may increase calcification rates, but at a cost. *Proceedings of the Royal Society B: Biological Sciences* 275:1767-1773.
- Zondervan I., Rost B. & Riebesell U., 2002. Effect of CO<sub>2</sub> concentration on the PIC/POC ratio in the coccolithophore *Emiliania huxleyi* grown under light-limiting conditions and different daylengths. *Journal of Experimental Marine Biology and Ecology* 272:55-70.

### 13 Measurements of calcification and dissolution of benthic organisms and communities

Chris Langdon<sup>1</sup>, Jean-Pierre Gattuso<sup>2,3</sup> and Andreas Andersson<sup>4</sup>

<sup>1</sup>Rosenstiel School of Marine and Atmospheric Science (RSMAS), University of Miami, USA

<sup>2</sup>Laboratoire d'Océanographie, CNRS, France

<sup>3</sup>Observatoire Océanologique, Université Pierre et Marie Curie-Paris 6, France

<sup>4</sup>Bermuda Institute of Ocean Sciences (BIOS), Bermuda

#### 13.1 Introduction

Approximately 25% of the global calcium carbonate production occurs in coastal environments despite accounting for only 7% of the global ocean area (Mackenzie *et al.*, 2004). Almost 50% of the calcium carbonate that accumulates in global marine sediments accumulates within this region, with about half of this accumulation in regions of coral reefs. On geological time scales this carbonate production influences the ocean chemistry, the carbon cycle and the Earth's climate (Ridgwell *et al.*, 2003). On shorter time scales, cause and effect are reversed and changes in the carbon cycle affect the rates of carbonate production and dissolution in the ocean. Laboratory and mesocosm studies have shown that the calcification rate of many calcium carbonate secreting organisms is negatively impacted by an increase in atmospheric CO<sub>2</sub>. Since calcification is a source of CO<sub>2</sub> on short time scales, a reduction in calcification would constitute a negative feedback on the build up of atmospheric CO<sub>2</sub>. The impact on the global carbon budget, however, is negligible given the mismatch in fluxes, i.e. 0.1 Pg C y<sup>-1</sup> vs. 9 Pg C y<sup>-1</sup> of anthropogenic CO<sub>2</sub> emissions. Far more important will be the negative impact on the organisms and the ecosystems they support. For this reason, interest in the measurement of calcification of shallow-living benthic organisms is becoming a hot research topic and it has been recognised at several national and international meetings that it is important that the way these measurements are made should be standardised so that the results are of high quality and intercomparable.

#### 13.2 Approaches and methodologies

The following sections cover the methods most appropriate to the measurement of calcification of benthic organisms and the calcification/dissolution of benthic ecosystems in the context of studying the impact of ocean acidification. See chapter 7 for some general thoughts about laboratory and benthic mesocosm experiments. The first choice an investigator must make is whether the experiments will be performed in a laboratory setting with well-controlled environmental conditions and good possibilities of replication or to attempt to make the measurements in a mesocosm or in the field where conditions can be less well controlled. In the purest case the investigator makes use of natural variability in the carbonate chemistry to perform the experiment and studies the response against a background of natural variability of many uncontrolled parameters such as light, temperature, salinity, nutrients, flow and food availability. Each approach has its merits. The laboratory studies have the virtue of providing a clear test of a cause and effect relationship. However the results may lack real world applicability if they fail to take into account interactions that in the real world act to mitigate or accentuate the response of interest. Field studies have the virtue of including the full range of factor interactions; however, there are many challenges that need to be addressed. First, there is often no baseline against which to measure a climate-related change. Second, the rate of change due to uptake of fossil fuel CO<sub>2</sub>, although fast enough to be of concern over the next decades, is slow enough for it to take as long as ten years to observe a statistically significant change in calcification at present-day levels of precision. Third, diurnal and seasonal variability in carbonate parameters are much larger than the interannual and decadal changes. This poses sampling issues in order to prevent aliasing of the long-term signal.

Laboratory studies are needed to investigate the saturation state and pH thresholds for growth and reproduction, i.e. the point below which an individual organism or a population of organisms can not sustain itself in the long term

against natural rates of attrition. This needs to be studied in simple single factor experiments with three or more saturation states / pH levels (see chapter 3 for recommendations on CO<sub>2</sub> levels) and multi-factorial experiments that combine the influences of other important environmental factors, i.e. light, temperature, flow, nutrients and particulate food (see chapter 4 for designing experiments to maximise statistical inference). Laboratory experiments need to be performed on progressively longer time scales in order to investigate the possibility that the organisms have the potential to up-regulate ion transport or otherwise acclimate to low carbonate ion and higher H<sup>+</sup> concentrations.

Field studies are needed to establish accurate baseline values for primary production, calcification and dissolution against which future changes can be judged. High temporal and spatial variability pose a number of challenges to obtaining rate measurements that can be reliably used to judge trajectories of change. Most of the field methods that are available yield the rate of photosynthesis/calcification/dissolution over a small area and on a time scale of minutes to hours. It is very laborious to obtain an estimate of daily production and examples of systems with knowledge of seasonal variability are extremely rare. The best strategy may be to develop robust functional relationships between, on the one hand, photosynthesis and calcification and, on the other hand, irradiance and then use these relationships and irradiance data to obtain the daily integrated primary production and calcification (Gattuso *et al.*, 1996). A similar strategy is needed to develop relationships between primary production/calcification/dissolution and different bottom communities that can then be used with remotely sensed bottom characterisations to scale up rates to the landscape scale.

Before discussing the methods for measuring calcification and dissolution in detail it is useful to define some terms. Calcification is defined as the process of forming new CaCO<sub>3</sub> mineral. It can be measured either as the removal of dissolved [Ca<sup>2+</sup>] and/or total alkalinity (A<sub>T</sub>) from the water or as the increase in mass of the CaCO<sub>3</sub> mineral. Dissolution is the process whereby the solid mineral phase loses mass as the CaCO<sub>3</sub> breaks down into its dissolved ionic constituents Ca<sup>2+</sup> and CO<sub>3</sub><sup>2-</sup>. It can be measured as the loss in mass of the mineral phase or in the increase in dissolved [Ca<sup>2+</sup>] and/or A<sub>T</sub>. It is not always safe to infer dissolution from the loss of CaCO<sub>3</sub> mass because in many environments there are organisms that are actively breaking down CaCO<sub>3</sub> substrates by mechanical means that will result in the loss of mass but not in increased [Ca<sup>2+</sup>]. In this case, carbonate fines are being produced but the phase change from solid to the dissolved ionic form is not occurring. The term “net calcification” is defined as calcification minus dissolution. Most of the methods to be discussed below measure net calcification (or net dissolution), which is not truly a single process but the difference between two processes (calcification and dissolution). This has given rise to the term “gross calcification” when one wants to make clear that the process that has been measured is the true rate of calcification before any deductions for dissolution have been made. Only short-term measurements of the incorporation of <sup>45</sup>Ca are likely to provide a measurement of gross calcification. However, in the laboratory and in the field under special circumstances, methods measuring net calcification can measure something close to calcification or dissolution if steps have been taken to ensure that the other process is not active. For example, any of the methods based on measuring a net change in [Ca<sup>2+</sup>], total alkalinity or CaCO<sub>3</sub> mass can be expected to give an accurate measurement of the calcification rate in a laboratory setting for a coral colony that has been allowed to completely heal over any exposed skeleton if the saturation state of the media is highly supersaturated. Conversely, the same methods can reasonably be expected to give an accurate measurement of dissolution if sterilised carbonate sediments were placed in a beaker filled with undersaturated seawater. The complications come in when the objective is to measure calcification and/or dissolution under more natural conditions when both processes are proceeding. A suitable method for measuring gross calcification or dissolution in the field under a wide range of natural conditions does not exist at this time.

### 13.3 Calcification

#### 13.3.1 Organismal scale measurements

Common to all organismal scale measurements of calcification is the need to place the organism in some sort of enclosure such as a well slide, beaker, aquaria tank, flow-through chamber or mesocosm and the need to be able to control the carbonate chemistry of the seawater within the enclosure (Figure 13.1). The biomass to volume ratio is



an important consideration. The volume of water must be small enough that you will be able to accurately measure the change in  $A_T$  or  $[Ca^{2+}]$  if that is how you quantify the rate of calcification. If this is not the case then the other constraint is that you want to keep the biomass to volume ratio as small as possible so as to minimise the change in carbonate chemistry that will result from the metabolism of the organism(s) under test.

It is essential to have some foreknowledge of the photosynthetic, respiration and calcification rate of the organism so that you can compute the expected change in carbonate chemistry over the course of your experiment. There are no hard and fast rules but you may want to keep the change in  $A_T$  and DIC to less than 10% and you certainly want to make sure that the change in pH or  $p(CO_2)$  is small relative to the difference between your treatment levels. This will be said again later but it is important to measure the carbonate chemistry at the beginning and end of your experiment so that you can report the average over the course of the experiment, because it will almost certainly be different than the values at the beginning. For short-term experiments it may be sufficient to set the chemistry at the beginning of the experiment. For longer duration experiments it is best to bubble with an air- $CO_2$  mixture of the desired  $CO_2$  concentration (see chapter 2). This permits holding the carbonate chemistry constant for extended periods of time even in open-top systems.

Open-top systems are desirable when dealing with photosynthetic organisms or organisms that possess photosynthetic symbionts because there is nothing to shade or alter the spectral quality of the light striking the organism. However, in the absence of a top one needs to be concerned about evaporation and gas exchange. Maintaining a flow of seawater through the open-top system that is large relative to the loss of water by evaporation is generally adequate for keeping the salinity variations to a minimum. It is good practice to always monitor the salinity on a regular basis. The loss of  $CO_2$  through gas exchange can be dealt with by bubbling the system with gas that has a  $CO_2$  concentration that is greater than the target concentration. How much higher will depend on many variables and must be determined empirically for each installation. While intuitively bubbling harder might be expected to hasten the rate of equilibration it also increases turbulence at the air-water boundary and hence accelerates gas exchange. The enclosure needs to be small enough to allow replication within a reasonable space and budget, yet large enough not to introduce a confinement effect. Where replication of enclosure is not possible then it is permissible to conduct replication in time where treatments are imposed sequentially on organisms in the same enclosure as long as control



**Figure 13.1** *In situ* carbonate manipulation experiments with the coral *Porites astreoides*, Conch Reef, Florida Keys (photo credit: B. Skerry).

conditions are interposed between treatment conditions (see chapter 4). It is important that the enclosures be designed such that other factors known to affect the rate of calcification can be controlled. This would include temperature, light, nutrients and water flow. For experiments that run for days to weeks it is important to feed the organisms a natural or artificial diet, because the condition of the organism is known to affect the rate of calcification. In general, it is important to take the time to demonstrate that the experimental set-up permits near normal growth of the organism before embarking on an experiment. If the organism is large or has a very active metabolism, a flow-through enclosure may be the best choice. In this case the rate of calcification would be related to the difference in some parameter between the inlet and outlet water. If the intent of the experiment is to look at the long-term response of the calcification of the organism to different carbonate chemistries, an open-top enclosure that is easy to clean and maintain and that does not alter the light quality experienced by the organism may be the best choice.

Five methods are in wide use for the study of calcification of benthic organisms, (1) incorporation of radioisotope <sup>45</sup>Ca, (2) change in the total alkalinity ( $A_T$ ) of the water in which the organism has been incubated, (3) change in the buoyant weight of the organism, (4) skeletal density banding and (5) direct measurement of shell or skeleton weight. A few studies have used the change in [Ca<sup>2+</sup>] measured by an EGTA titration. Each method is described below. A few key references are provided: often an older paper that discusses the assumptions of the method and a few recent references that illustrate the use of the method to study an ocean acidification related problem. These few citations should be sufficient to lead the interested reader to the relevant literature. No attempt has been made to provide a thorough review of each method. This document is intended to be a short introduction to the methods available for studying the calcification of benthic organisms and communities in the context of understanding their response to ocean acidification.

### 13.3.2 <sup>45</sup>Ca radioisotope method

The first direct measurements of coral calcification were performed in the 1950s (Goreau & Bowen, 1955; Goreau, 1959) using the radioisotope <sup>45</sup>Ca. The method involves the incubation of a freshly obtained fragment of a coral colony in a volume of seawater containing radioactive <sup>45</sup>Ca of a known specific activity. After an incubation period of minutes to hours, pieces of the colony is clipped off with cutters in the case of branching corals or extracted with a coring tool in the case of massive corals. The piece of coral is briefly rinsed in filtered seawater, the tissue removed, the skeleton dried, dissolved on strong acid and the incorporated radioactivity measured using a scintillation counter. Rates can be normalised to the amount of nitrogen extracted from the tissue (presumed proportional to the amount of protein) or surface area of the live tissue. The earlier method is sensitive and revealed interesting differences between species and even across the surface of an individual colony. However, the rates exhibited a high coefficient of variability (CVs of 30 to 50%) between replicates prepared from the same colony and significantly overestimated the rate obtained by the alkalinity and buoyant weight methods. The latter problem was due to non-biologically mediated isotopic exchange at the skeleton-tissue interface and, to varying degrees, with cellular and intercellular compartments. As a result the method fell out of favour. This has changed with the advent of improved methodology (Tambutté *et al.*, 1995). First, the uptake of <sup>45</sup>Ca onto the exposed skeleton of freshly fragmented coral colonies, which contributed to a high blank, was eliminated by creating small colonies where the tissue was allowed to grow completely over the regions of exposed skeleton before they were used in an experiment. Second, careful efflux experiments showed that there was a large, exchangeable pool of <sup>45</sup>Ca, presumably in the coelentric cavity and a smaller exchangeable pool in the tissue (NaOH-soluble fraction) that took many minutes to rinse out. When the rinsing period was extended from the original 1 min to 30 min the coefficient of variation of the method was observed to greatly improve as did the agreement with the alkalinity method (Tambutté *et al.*, 1995). The strength of the radioisotope method is that it is extremely sensitive so the measurement period can be minutes. It is the only method suitable for studying kinetics and pathways of Ca<sup>2+</sup> transport. The weakness of the method is that the organism must be destroyed to be analysed and it is not easily scaled up for use on large organisms or on many organisms in a mesocosm or in the field. Precision (coefficient of variation CV) is reported to be ±12% using the latest protocols. An intercomparison study by Tambutté *et al.* (1995) found that calcification rates obtained by <sup>45</sup>Ca uptake and the total alkalinity anomaly technique were highly correlated but that the <sup>45</sup>Ca uptake method underestimated calcification

based on the  $A_T$  anomaly method by ~12% and registered a zero rate when there is measurable calcification based on the  $A_T$  method.

It is possible that dissolution could be measured by placing an organism in  $^{45}\text{Ca}$  spiked seawater for hours to days to allow the skeleton to become completely labelled and then place the organism in unlabelled seawater and measure dissolution by the efflux of  $^{45}\text{Ca}$ . It does not seem that this method has been used but it seems feasible.

### 13.3.3 Alkalinity anomaly method

This widely used method described by Smith & Key (1975) assumes that when a mole of  $\text{CaCO}_3$  is produced (dissolved) the total alkalinity ( $A_T$ ) is decreased (increased) by two moles. See chapter 1 as well as Zeebe & Wolf-Gladrow (2001) for a definition of total alkalinity.  $A_T$  can be altered by the uptake and release of  $\text{PO}_4^{3-}$ ,  $\text{NO}_3^-$ , and  $\text{NH}_4^+$  associated with photosynthesis and remineralisation (Brewer & Goldman, 1976) and by sulfate reduction (Berner *et al.*, 1970; Gaines & Pilson 1972). Kinsey (1978a) and Gattuso *et al.* (1999) pointed out that these fluxes should be of minor importance in most reef settings but they could be important in other environments. In any case, they must be taken into account if the change in concentration of any of these constituents is significant relative to the expected change in  $A_T$ . For batch culture studies with coccolithophorids grown in nutrient-enriched media, the nutrient correction would be important. In most tropical coral work, a nutrient correction is not important because the nutrient concentrations are very low (Kinsey, 1978a; Smith, 1995). Chisholm & Gattuso (1991) compared calcification measurements of coral based on the uptake of  $\text{Ca}^{2+}$  and the change in  $A_T$  and confirmed the validity of the alkalinity approach with and without a nutrient correction. The net calcification rate is given by:

$$g = -0.5\rho_w \frac{\Delta A_T}{\Delta t} \quad (13.1)$$

where  $g$  is the calcification rate in  $\text{mmol CaCO}_3 \text{ m}^{-3}$  per unit time,  $\rho_w$  is the seawater density ( $\text{kg m}^{-3}$ ), and  $\Delta A_T/\Delta t$  is the rate of change in  $A_T$  ( $\text{mmol kg}^{-1}$ ) per unit time.

The organism under test is placed in a container of water and the change in  $A_T$  is observed over some period of time. It must be recognised that the calcification, photosynthesis and respiration of the organism is changing the carbonate chemistry of the water as the experiment proceeds. A certain amount of change in  $A_T$  is needed to obtain an accurate measurement of the calcification rate, i.e. the measured change in  $A_T$  needs to be 3 to 10 times the analytical precision of the measurement ( $\sigma = 2 \mu\text{mol kg}^{-1}$ ). This can be assured by adjusting the volume of water the organism is kept in and the amount of time between the initial and final  $A_T$  measurements. While it is desirable for the change in  $A_T$  during the incubation to be large it must be recognised that this change in  $A_T$  and the accompanying change in DIC is changing the pH,  $\text{p}(\text{CO}_2)$ ,  $\text{CO}_3^{2-}$  and carbonate saturation state of the water at the same time (see chapter 1). Since the purpose of the experiment is to relate the rate of calcification to one of these parameters it is important that the change in  $A_T$  is not allowed to become too large. Designing a good experiment becomes a matter of choosing a volume and a time interval such that the change in pH,  $\text{p}(\text{CO}_2)$ ,  $\text{CO}_3^{2-}$  or saturation state between the beginning and end of the experiment is small compared to the range of that parameter in the different treatments and that the precision of the calcification rate measurement is large enough to resolve a treatment effect with acceptable power. It is highly recommended to measure  $A_T$  and DIC at the beginning and end of incubation so that the average pH,  $\text{p}(\text{CO}_2)$ ,  $\text{CO}_3^{2-}$  and saturation state during the experiment can be computed.

The water should be well mixed so that the water samples that are withdrawn for the analysis of  $A_T$  are representative of the entire volume. It is also important to consider that concentration gradients may build up around the organism if the water flow is not adequate. Mixing can be achieved by a magnetic stirrer, small pump or by bubbling.

Recent examples of studies that have employed the alkalinity anomaly method in relation to ocean acidification research include Gattuso *et al.* (1998), Langdon *et al.* (2000, 2003), Leclercq *et al.* (2000, 2002), Schneider & Erez (2006), Langdon & Atkinson (2005) and Gazeau *et al.* (2007). The strengths of the alkalinity anomaly method are that it is non-destructive, broadly applicable to small (1 l) and short (1 to 3 h) or large (more than 1000 m<sup>3</sup>) and long experiments (days to months) and useful for both calcification and dissolution studies. The weaknesses of the method are that in certain environments the uptake and release of  $\text{PO}_4^{3-}$ ,  $\text{NO}_3^-$ ,  $\text{NH}_4^+$ ,  $\text{SO}_4^{2-}$  and organic acids can

cause a change in  $A_T$  unrelated to calcification and dissolution. Based on the propagated errors in the initial and final  $A_T$  measurements, a precision of  $\pm 2$  to 4 mmol CaCO<sub>3</sub> m<sup>-3</sup> is possible with this method. The accuracy of the alkalinity anomaly method has been confirmed against the Ca<sup>2+</sup> method (Chisholm & Gattuso, 1991).

### 13.3.4 Buoyant weighing method

The buoyant weighing method was described in detail by Jokiel *et al.* (1978). Calcification is inferred from changes in skeletal weight of a living organism estimated by weighing it in seawater of which the density has been accurately determined. By applying Archimedes' principle it is possible to compute the dry weight of the specimen in the air:

$$W_a = \frac{W_w}{1 - (\rho_w / \rho_s)}; \quad (13.2)$$

where  $W_a$  is the weight in air or the dry weight,  $W_w$  is the wet or buoyant weight of the specimen,  $\rho_w$  is the density of the water, and  $\rho_s$  is the density of the skeletal material. While it is the dry weight that is needed, it is desirable to make the measurement in the water for several reasons. First, it is less stressful on the organism. Second, it eliminates the need to dry the specimen of any water clinging to the surface or retained in cavities within the specimen. The calcification rate is given by the expression:

$$G = \frac{\Delta W_a}{\Delta t}; \quad (13.3)$$

where  $G$  (a capital  $G$  is used to be consistent with the convention in the ecological literature that symbols denoting daily rates are capitalised and symbols denoting hourly rates are in lower-case) is the daily calcification rate (mg CaCO<sub>3</sub> d<sup>-1</sup>),  $\Delta W_a$  is the change in dry skeletal weight and  $\Delta t$  is the number of days between weighings. In the case of corals, it is common practice to normalise the rate to the surface area of live tissue estimated by a geometric formula if the colony has a simple geometry or by the wax-dripping technique for more complex geometries (Stimson & Kinzie, 1991). For other organisms, it is more common to normalise the rate to the initial weight of the organism.

The method has been extensively employed to measure the calcification of stony corals (Jokiel & Coles, 1977; Jokiel *et al.*, 1978; Dodge *et al.*, 1984; Davies, 1989). Jokiel *et al.* (1978) stated that the method is insensitive to the weight of soft tissue because its density is very similar to that of seawater. However, Davies (1989) compared the buoyant weight of two species of coral before and after stripping away the tissue and found that the soft tissue contributed 0.9% of the buoyant weight in *Pocillopora verrucosa* and 5.3% in *Acropora humilis*. He recommended that a tissue weight correction be applied in order to obtain skeletal weights accurate to 1%. The method has generally been used to measure calcification over weekly intervals or longer, however, Davies (1989) used it to measure daily rates and even the difference between day and night rates. Given that the percent change in skeletal weight per day is in the range of 0.2 to 1.1% per day (Marubini *et al.*, 2001), it is apparent that even if careful correction is made for changes in tissue weight the method is best used to study weekly changes or longer.

Caution should be exercised in applying the buoyant weighing method to the measurement of calcification in organisms other than corals where the contribution of soft tissue weight to the weight of the calcium carbonate parts may be substantial. See Ries *et al.* (2009) for an example of the application of this method to a wide range of calcifying benthic organisms. Where the ratio of soft tissue to skeletal mass is not small it would be wise to test the method against the  $A_T$  or [Ca<sup>2+</sup>] methods before trusting.

Recent examples of studies employing the buoyant weighing method related to ocean acidification research include Marubini *et al.* (2001, 2002, 2008), Reynaud *et al.* (2003), Ohde & Hossain (2004), Renegar & Riegl (2005), Jokiel *et al.* (2008) and Ries *et al.* (2009).

The strengths of the buoyant weight method are that it is very simple, non-destructive, and easily applied to a large number of replicates. The major weakness of the method is that some of the increase in mass may not be due to building of new skeleton, i.e. some of the increase may be due to an increase in the mass of soft tissue. The CV of the method is 10 to 50% (typical is 20 to 25%). The accuracy of the method is unknown because it has not been compared with either the  $A_T$  or Ca<sup>2+</sup> depletion methods.

### 13.3.5 Skeletal density banding

This method has been applied to obtain records of calcification rate for a few species of massive coral that reach back in time anywhere from 15 to 300 years. This method is limited to the few species of coral that produce an annual high-density band that permits accurate dating of the skeleton (Figure 13.2). The distance between annual bands is a measure of the annual skeletal extension rate. The density of the skeletal material can be measured by X-ray or gamma densitometry along the axis of growth and averaged over each year's growth. The calcification is given by:

$$G = E\rho_s; \quad (13.4)$$

where  $G$  is the annual calcification rate ( $\text{g CaCO}_3 \text{ cm}^{-2} \text{ y}^{-1}$ ),  $E$  is the annual skeletal extension rate ( $\text{cm y}^{-1}$ ) and the  $\rho_s$  is the skeletal density ( $\text{g cm}^{-3}$ ).

Recent examples of studies employing the skeletal densitometry method related to ocean acidification research include Cooper *et al.* (2008), De'ath *et al.* (2009) and Tanzil *et al.* (2009). This method may also be useful for the study of calcification in molluscs that also produce skeletal density bands that may permit to estimate the age and the calcification rate of the shell. The strength of the skeletal density banding method is that it is the only method that can be applied to retrospective studies going back as much as 300 years. The main weakness of the method is that skeletal records are often very noisy requiring that the records from many organisms be averaged to obtain a significant result. Also, the method is limited to the few species that produce an annual skeletal density band and these species are not found in all environments.

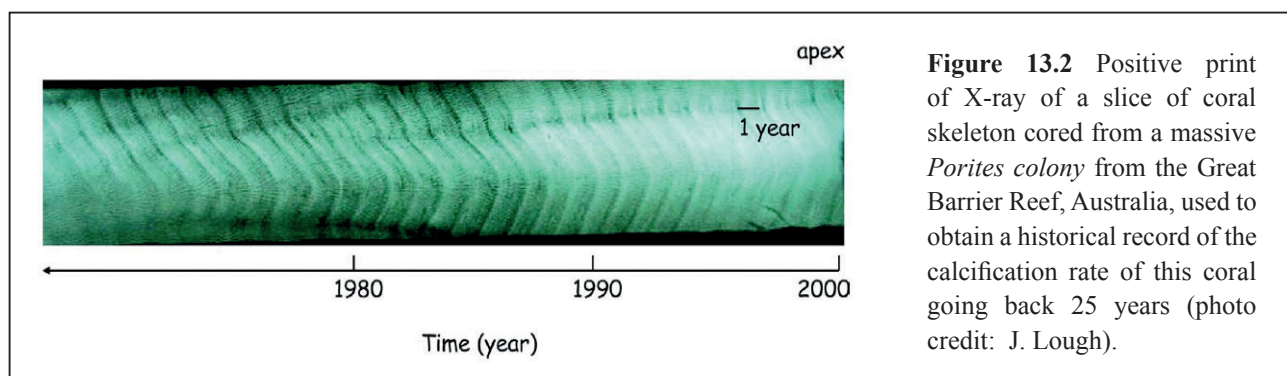

### 13.3.6 Direct measurement of skeleton or shell carbonate

The direct measurement of shell or skeleton weight has been used to quantify the calcification of mollusc larvae (Miller *et al.*, 2009) or new coral recruits (Cohen *et al.*, 2009). In the case of the Miller *et al.* (2009) study, shells were rinsed in deionised water (DIW) to remove sea salts and then dissolved in trace metal grade HCl, made up of a known volume with DIW and the solution analysed for  $[\text{Ca}^{2+}]$  by ICP-OES (Inductively Coupled Plasma – Optical Emission Spectroscopy) to obtain the calcium content per shell. In the Cohen *et al.* (2009) study, the skeletons of the new coral recruits were carefully collected by fine forceps and weighed in a micro-balance. The strengths of the method are that it provides a direct measurement of calcification and it can easily handle a large number of replicates. The weakness of the method is that it is destructive.

### 13.3.7 Community scale measurements

There are four methods that have been used to measure calcification rates of benthic communities; the slack-water/enclosure/mesocosm, flow respirometry, alkalinity depletion-water residence and the biological estimator methods. These methods will be described below along with a mention of their strengths, weaknesses, precision and accuracy.

#### *Slack water, enclosure and mesocosm measurements*

Kinsey (1978b) described a method for measuring the calcification rate of a coral reef flat by observing the change in total alkalinity during a period of slack water at low tide. While the method can only be employed

during the 3 to 5 h of slack water low tide each day, it is possible to build up a composite diurnal curve over a period of many days by taking advantage of the fact that the tide advances by 50 min each day. The only measurements that are needed are the total alkalinity and water depth at the beginning and end of the 1 to 3 h observation period. The method is only suitable for certain environments including tidal pools, crest pools, back reef environments, sand and reef flats, lagoonal environments and depressed centres of patch reefs (“micro-atolls”). It is also possible to use an enclosure to isolate the community to investigate (Kinsey, 1978b; Gattuso *et al.*, 1997). Care must be taken to sample adequately in the vertical, for example by taking vertically-integrated samples, if it is observed that there is stratification of  $A_T$  within the water column. The hourly net calcification rate is calculated as:

$$g = \frac{-0.5\Delta A_T \rho_w h}{\Delta t}; \quad (13.5)$$

where  $g$  is the net calcification rate (mmol CaCO<sub>3</sub> m<sup>-2</sup> h<sup>-1</sup>),  $\Delta A_T$  is the change in  $A_T$  in mmol kg<sup>-1</sup>,  $\rho_w$  is the density of the seawater (kg m<sup>-3</sup>),  $h$  is the mean water depth (m) and  $\Delta t$  is the time interval between observations (h).

Mesocosms provide a unique way to measure net calcification under controlled conditions (Figure 13.3). If a mesocosm (continuous flow or static) is a well-mixed system, it can be treated as a simple box model where the rate of change in  $A_T$  ( $dA_T/dt$ ) in the reservoir can be described by the equation (Andersson *et al.*, 2009):

$$\frac{dA_T}{dt} = F_{A_T, \text{in}} - F_{A_T, \text{out}} - 2g; \quad (13.4)$$

where  $F_{A_T, \text{in}}$  is the input of  $A_T$  in mmol m<sup>-2</sup> h<sup>-1</sup>,  $F_{A_T, \text{out}}$  is the output of  $A_T$  in mmol m<sup>-2</sup> h<sup>-1</sup> and  $g$  is the net calcification rate in mmol CaCO<sub>3</sub> m<sup>-2</sup> h<sup>-1</sup>. Assuming that  $A_T$  in the mesocosm is only affected by the input and output of  $A_T$ , as well as calcification and dissolution processes, the net calcification rate can be calculated according to:

$$g = 0.5 \times \left( F_{A_T, \text{in}} - F_{A_T, \text{out}} - \frac{dA_T}{dt} \right). \quad (13.5)$$

These parameters are easily characterised by keeping track of the inflow and outflow rate of seawater to the system, and measuring the  $A_T$  in the input seawater as well as inside the mesocosm at regular intervals. Since the system is well mixed, the  $A_T$  of the output seawater is equal to the  $A_T$  inside the mesocosm. It is recommended to ensure that the system indeed is well mixed before using this approach.

Most of what we know about seasonal changes in calcification at a particular site and the variability in calcification from reef to reef is based on the application of the slack-water method (Kinsey, 1978a,b). The ability to control the chemistry of the seawater within an enclosure placed over a portion of a natural community makes it the method of choice for studying the functional response of benthic community calcification to changes in carbonate chemistry (Yates & Halley, 2003, 2006; Figure 13.4). Where more control over environmental conditions is desired, a mesocosm with a well characterised community can be constructed (e.g., Langdon *et al.*, 2000; Leclercq *et al.*, 2000). The strength of the slack-water method is that it is easy to implement, requiring only knowledge of water depth and  $A_T$  change at a single location. Compared with

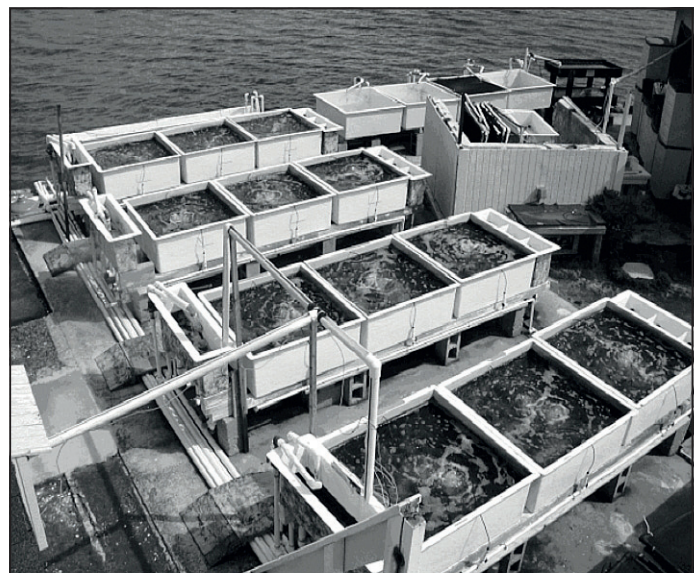

**Figure 13.3** Outdoor continuous-flow mesocosms for studying the long term impacts of ocean acidification on coral reef organisms at the Hawaii Institute of Marine Biology (HIMB) (used with permission from Andersson *et al.*, 2009).

the flow studies, the slack-water method can be applied to smaller, more discrete communities allowing a comparison between calcification rate and community structure. Fences or corrals can be used to achieve even finer scale studies of particular communities. The weakness of the slack-water method is that it is only possible to make measurements for a few hours out of the day, making daily rates difficult to obtain. Enclosures give freedom from the slack-water constraint, offer the possibility for manipulative experiments and can be placed over or around a specific community of interest. However, the enclosure may alter the physical environment and hence bias the calcification rate obtained. Furthermore, some environments are too energetic for using enclosures or do not enable to achieve a good isolation of the seawater. Mesocosms may offer

a good compromise, permitting reproducibility as well as to derive accurate mass balances and control the physical and chemical conditions. The weakness of the mesocosm method is that the community under test is not completely natural but a subset of species that have been assembled to simulate the natural environment. The precision of the calcification rates can be high, i.e.  $\pm 1.7 \text{ mmol CaCO}_3 \text{ m}^{-2} \text{ h}^{-1}$ .

### **Flow respirometry method**

The flow respirometry or upstream-downstream method described by Odum (1956) has been widely used to measure the primary production in rivers and streams. It has been adapted for the measurement of primary production and calcification of coral reefs (Marsh & Smith, 1978; Barnes, 1983; Griffith *et al.*, 1987; Gattuso *et al.*, 1993, 1996, 1999; Figure 13.5). Basically, the method involves the measurement of the chemical constituent of interest ( $\text{O}_2$ , dissolved inorganic carbon or total alkalinity) immediately before a parcel of water begins its transit across a particular community and immediately downstream of the community. If the change in that chemical constituent of the water is divided by the water transit time, then the net rate at which the community alters that chemical constituent is determined. The method is limited to environments that experience unidirectional flow of water. It has been most widely applied to reef flats that experience unidirectional flow during periods of incoming and outgoing tide or as the result of set up caused by waves breaking out at the reef crest. It is also possible to find fringing coral reefs that experience seasonal unidirectional flow due to the existence of trade winds. If the sampling transect has biological zones which are broad and perpendicular to the direction of water flow (a reasonable assumption for many reef systems), then lateral mixing of water as it crosses the reef will not introduce a significant error into the estimate of the change in concentration along the transect.

There are Eulerian and Lagrangian approaches to the flowing water method. The distinction refers to the frame of reference. If observations are made at a fixed position over time the method is referred to as Eulerian. If observations are made with respect to the flowing parcel of water as it moves through the system of interest, the method is referred to as Lagrangian. The Eulerian method involves collecting two water samples for  $A_T$  as nearly contemporaneous as possible at the upstream and downstream ends of a transect across a portion of a



**Figure 13.4** Underwater enclosure (SHARQ) deployed in the U.S. Virgin Islands. The SHARQ is used for *in situ* perturbation studies on the impact of ocean acidification on benthic communities (photo credit: K. Yates).

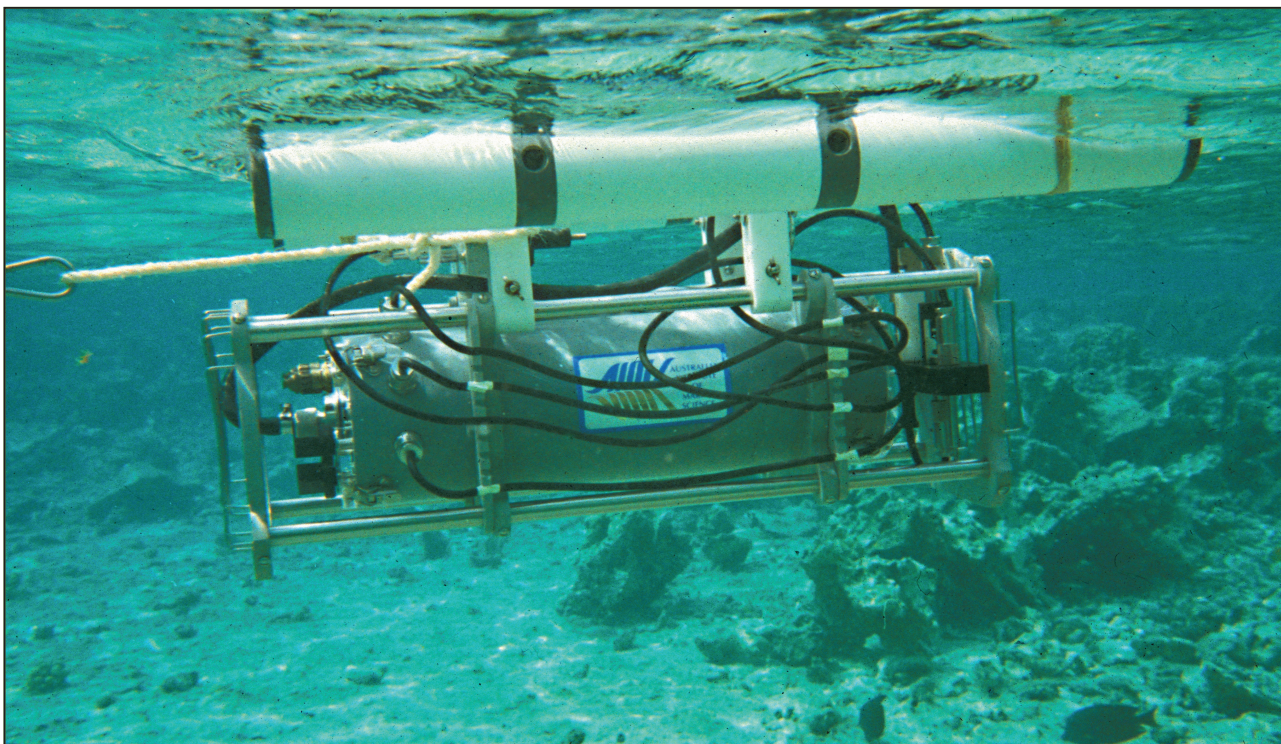

**Figure 13.5** Floating instrument package recording pH, oxygen concentration, temperature and irradiance (Gattuso *et al.*, 1993, 1996, 1997). This instrument was designed by the Australian Institute of Marine Science (photo credit: J.-P. Gattuso).

reef. In addition, it is necessary to know the mean water depth along the transect and the current speed at the time of the observations. The calcification rate  $g$  (mmol CaCO<sub>3</sub> m<sup>-2</sup> time<sup>-1</sup>) is calculated as:

$$g = -0.5 \left( \frac{3600}{100} \right) \frac{(A_{Td} - A_{Tu}) \rho_w u h}{L}; \quad (13.6)$$

where (3600/100) is the factor that converts cm s<sup>-1</sup> to m h<sup>-1</sup>,  $A_{Tu}$  and  $A_{Td}$  are the up- and downstream total alkalinity  $A_T$  respectively in (mmol kg<sup>-1</sup>),  $\rho_w$  is the seawater density (kg m<sup>-3</sup>),  $u$  is the current speed (cm s<sup>-1</sup>),  $h$  is the water depth (m) and  $L$  is the transect length (m).

The Lagrangian approach involves using dye or a drogued drifter to track a parcel of water as it transits the portion of the reef under study and collecting a water sample for  $A_T$  at the beginning and end of the transect. The calcification rate  $g$  (mmol CaCO<sub>3</sub> m<sup>-2</sup> time<sup>-1</sup>) is calculated as:

$$g = -0.5 \frac{(A_{Td} - A_{Tu}) \rho_w h}{\Delta t}; \quad (13.7)$$

where  $\Delta t$  is the duration of the transect in hours and the other terms are as previously defined.

Either measurement must be repeated many times over the course of a day or several days in order to develop a composite diel curve of calcification that can be integrated to obtain the daily calcification rate,  $G$  mmol CaCO<sub>3</sub> m<sup>-2</sup> d<sup>-1</sup>. The Eulerian approach could be automated by the use of two autonomous water samplers and a current meter if one could be reasonably sure that flow would remain unidirectional for a period of time or if only water samples collected during periods of unidirectional flow were subsequently analysed based on analysis of the current direction data. The Lagrangian method has been automated by placing a pH and oxygen sensor on a drifting instrument package (Barnes *et al.*, 1984; Gattuso *et al.*, 1993). Of course the package still needs to be deployed at the start point of the transect over and over in order to develop the temporal data needed to estimate the daily rate.



Recent studies that have employed the flowing water method to measure community calcification include Falter *et al.* (2008) for the Eulerian method and Barnes *et al.* (1984) and Gattuso *et al.* (1993) for the Lagrangian method. The strength of the method is that it measures community calcification under completely natural conditions. The weakness of the method is that it is limited to systems that experience unidirectional flow, does not account for lateral mixing (if biological zones are fairly broad then the lateral mixing term is probably small) and it is very laborious to obtain a daily rate. Based on propagation of the uncertainty in the up and down stream  $A_T$ , the precision of the method is on the order of  $\pm 5 \text{ mmol CaCO}_3 \text{ m}^{-2} \text{ h}^{-1}$  based on typical values for  $h$  and  $u$ .

#### **Alkalinity anomaly-water residence time method**

The alkalinity anomaly-water residence time method is suitable for lagoons, bays and banks where the residence time of the water is measured in days rather than hours. Like the slack and flowing water methods discussed above, the alkalinity depletion method assumes that total alkalinity is reduced by two equivalents for every mole of  $\text{CaCO}_3$  precipitated from a given volume of water that has remained in contact with a given map area of the reef community for some measureable length of time. Therefore, the calcification rate equals half the decrease in  $A_T$  times the mean water depth divided by the length of time the water remains in the system. The  $A_T$  of water flowing over a reef can change due to processes other than the precipitation and dissolution of  $\text{CaCO}_3$ . The important processes are rainfall, evaporation and groundwater input. In most cases, these processes are too slow to affect the  $A_T$  significantly during the 1 to 3 h observation period involved in the application of the slack and flowing water methods discussed above. However, when the water residence time is measured in days to weeks they can become significant. Rainfall and evaporation are easy to deal with. They add or remove  $A_T$ -free water and so they change the salinity and  $A_T$  in proportion to one another. Normalising the  $A_T$  to a constant salinity value (typically 35) removes the effects of rainfall and evaporation. The effect of input of groundwater on  $A_T$  is more complicated because the groundwater from coral islands tends to have a high and variable  $A_T$ . However, groundwater is only likely to be important if the reef in question is associated with a landmass which has a large freshwater lens. Unless the groundwater input dilutes the salinity by more than 0.1 ppt it can usually be ignored (Smith, 1978). In the event that the groundwater input is judged to be significant, Smith & Pesret (1974) describe a way to make a correction based on sampling the  $A_T$  over a vertical profile extending from the overlying seawater down into the groundwater lens. Elevated sulfide, nitrate or ammonia concentrations can impact  $A_T$ , however, in normal reef waters nutrient levels are generally very low and as long as the water is aerated the sulfide concentration will be low.

In practice, the salinity and  $A_T$  is measured in the waters offshore of the reef system of interest. This water is assumed to be the source of the waters found on the reef. Further, it is assumed that the  $A_T$  of the source water does not change significantly over a period of time equal to or longer than the water residence of the system of interest. A spatial survey of salinity and  $A_T$  is then made across the system. From this, the spatially and temporally integrated calcification rate of the community can be computed as:

$$G = -0.5(nA_{T0} - nA_{Tr}) \frac{\rho_w h}{\tau}; \quad (13.8)$$

where  $G$  is the daily calcification rate ( $\text{mmol CaCO}_3 \text{ m}^{-2} \text{ d}^{-1}$ ),  $nA_{T0}$  is the salinity-normalised total alkalinity in offshore source water and  $nA_{Tr}$  is the salinity-normalised  $A_T$  of the reef water (both in  $\text{mmol kg}^{-1}$ ),  $\rho_w$  is the density of the water ( $\text{kg m}^{-3}$ ),  $h$  is the average water depth (m) and  $\tau$  is the residence time of the water on the reef (days).

The water residence time,  $\tau$ , is defined as the time span over which a particular parcel of water remains in the system of interest. In the case where the flow of water is unidirectional,  $\tau$  is the volume of water ( $\text{m}^3$ ) divided by the volume transport ( $\text{m}^3 \text{ s}^{-1}$ ) of that water across an imaginary vertical plane drawn through the system of interest. In practice, both the volume of water and the volume transport are expressed per unit width of reef perpendicular to the flow. In cases where the flow is more complex, other strategies need to be employed to obtain the residence time. Smith & Pesret (1974) and Smith & Jokiel (1978) used budgets of salt- and freshwater flux to estimate  $\tau$  using the following equation (see also Gordon *et al.*, 1996):

$$\tau = \left( \frac{h}{e - p - q} \right) \frac{(S_h - S_0)}{S_0}; \quad (13.9)$$

where  $\tau$  is the residence or exchange time (d),  $h$  is the mean water depth of the basin (m),  $e$  and  $p$  are the daily evaporation and precipitation rates (m d<sup>-1</sup>) for the period preceding the salinity measurements not the long term averages,  $q$  is the river or ground water flow (m<sup>3</sup> d<sup>-1</sup>) divided by the surface area of the basin (m<sup>2</sup>),  $S_0$  is the salinity of the offshore oceanic water entering the system and  $S_b$  is the salinity of the water in the basin. The  $q$  term can be neglected if there is no river flow into the system or if groundwater flow is assumed to be negligible. Broecker & Takahashi (1966) used the relationship between bomb-produced <sup>14</sup>C in the atmosphere and the <sup>14</sup>C of the water overlying the Bahama Banks to estimate water residence time and found that it compared favourably with the residence time estimated from the salt budget.

A recent example of a study employing the alkalinity depletion-water residence time method related to ocean acidification research is Silverman *et al.* (2007). The strength of the method is that it is temporally averaged over the residence time of the water, which is typically days to weeks, and spatially averaged over the whole basin, lagoon, bay or bank. The method is not suitable for systems where water residence times are very short, i.e.  $\tau < 1$  day.

### **Biological estimators**

Calcification can be estimated as the product of the standing crop (or calcimass) and specific growth or turnover rate of each calcifying organism in the system of interest (Smith, 1972). Alternatively, it can be calculated using the density of the population, its demographic structure and a relationship between size and weight of CaCO<sub>3</sub> (Migné *et al.*, 1998). Biological estimators are tedious but useful in areas dominated by a single or a small number of species. They estimate gross community calcification if the standing crop is used to normalise the data or the potential calcification if the organisms considered are assumed to cover 100% of the area. The strength of the method is that it provides a way to validate estimates based on changes in water chemistry against organismal-based estimates. The weakness of the method is that because of the large amount of information required by this approach, no such study has been truly comprehensive except one in the Southern Californian shelf (Smith, 1972).

## **13.4 Dissolution**

### **13.4.1 General considerations**

In general, net carbonate dissolution can be qualitatively inferred or quantitatively determined by (1) changes in solution chemistry, (2) changes in substrate or organism weight and/or size, and (3) from visual evidence of dissolution from image analysis using for example microscopy, scanning electron microscopy (SEM), or atomic force microscopy (AFM). Several of the important considerations, approaches and methods previously described in section 13.3 relevant to net calcification measurements also apply to measurements of net carbonate dissolution under conditions where dissolution exceeds calcification. These methods will not be repeated in this section, but simply referred to. Although it may seem quite practical that the same methods apply to both calcification and dissolution studies, this highlights the major limitation common to these methods and measurements, i.e., they only measure the net effect of both calcification and dissolution processes. It is important to recognise this limitation when interpreting results or making comparisons between different studies and environments.

In this section, we will briefly introduce three general approaches used in dissolution studies relevant to benthic calcifying organisms and communities. However, carbonate dissolution in the context of ocean acidification goes far beyond what is covered here, including experiments directly addressing solubility and reaction kinetics of carbonate minerals (e.g. Walter & Morse, 1984, 1985; Morse & Mackenzie, 1990; Arvidson *et al.*, 2003; Morse *et al.*, 2007), dissolution of carbonate sediment and reef framework (e.g. Aller, 1982; Tribble *et al.*, 1990; Cai *et al.*, 1995; Berelson *et al.*, 1996; Burdige & Zimmerman, 2002) and bioerosion (e.g. Pari *et al.*, 2002; Tribollet *et al.*, 2002, 2006, 2009; Tribollet, 2008). The reader interested in these topics is referred to the above references and references therein.

### 13.4.2 Alkalinity anomaly methods in the context of dissolution

The underlying principle of the alkalinity anomaly method and its variations (e.g. the slack water method, the flowing-water method, and the alkalinity anomaly water residence time method; section 13.3.7) are the most widely used approaches to determine whether a calcifying organism or community contained within an experimental reservoir (e.g. an aquarium or mesocosm), or a community or ecosystem in a natural environment, is subject to net dissolution. In determining the extent of net dissolution, the methodology and procedure are the same as for estimating net calcification, but the reaction and the change in  $A_T$  are reversed, i.e., for every one mole of  $\text{CaCO}_3$  dissolved,  $A_T$  increases by two moles. As an example, in the alkalinity anomaly-water residence time method, if the system is subject to net dissolution,  $A_T$  will be replete rather than deplete relative to the offshore reference  $A_T$ .

Since net dissolution at the community and ecosystem scale is most likely to occur when rates of calcification and primary production are low, one has to exert additional care on the influence of nutrients and other constituents produced from respiration and microbial decomposition of organic matter on the  $A_T$ . Furthermore, in the event of development of anaerobic conditions in localised parts of the system being considered, net sulfate reduction and ammonium generated from decomposition of organic matter could significantly affect the  $A_T$  and consequently the dissolution estimate. This potential problem can be addressed by measuring both  $[\text{Ca}^{2+}]$  and  $A_T$ . Regardless of the influence of processes other than carbonate mineral dissolution on  $A_T$ , changes in  $[\text{Ca}^{2+}]$  at a fixed salinity will unequivocally reflect carbonate dissolution (or precipitation). By evaluating changes in salinity-normalised  $[\text{Ca}^{2+}]$  as a function of salinity-normalised  $A_T$ , it is possible to evaluate the influence of other constituents on the  $A_T$  and whether this is significant or not. As previously discussed in section 13.2, both calcification and dissolution could be evaluated by  $[\text{Ca}^{2+}]$  measurements, but because of the naturally high concentrations of calcium in seawater and the relatively small changes in concentration imposed by calcification and dissolution processes,  $[\text{Ca}^{2+}]$  measurements are not as precise and suitable as  $A_T$  measurements to detect these changes. Furthermore, changes in  $[\text{Ca}^{2+}]$  could underestimate total dissolution if the average composition of the dissolving mineral phase contains significant amounts of  $\text{Mg}^{2+}$ . However, for any precise dissolution work involving benthic communities, it is recommended that  $[\text{Ca}^{2+}]$  measurements are taken concurrently with  $A_T$  in order to rule out the influence of nutrients and other constituents on the  $A_T$ , and thus, the community net dissolution estimate.

Recent examples of studies that have measured net carbonate dissolution of calcifying communities based on the alkalinity anomaly method and its variations in the context of ocean acidification include Boucher *et al.* (1998), Langdon *et al.* (2000), Leclercq *et al.* (2002), Yates & Halley (2003, 2006), Silverman *et al.* (2007) and Andersson *et al.* (2007, 2009). The strengths and weaknesses of these methods are the same as outlined in the calcification section. Furthermore, it is important to realise that community net dissolution estimates based on the alkalinity anomaly method does not distinguish between: (1) different dissolution processes (e.g. metabolic dissolution or bioerosion), (2) where dissolution is taking place (e.g. in the sediments, reef structure, carbonate rubble, individual calcifiers, etc.) or (3) what mineral phases are subject to dissolution. Dissolution estimates based on the alkalinity anomaly method simply provide information about the total net dissolution owing to the sum of the different dissolution processes minus any calcification or precipitation of  $\text{CaCO}_3$  that is taking place in the system being considered.

### 13.4.3 Weight loss and changes in linear dimensions

One of the most straightforward principles to measure carbonate dissolution is to monitor the weight of the substrate or experimental subject being investigated. This stems from the original work by Peterson (1966), who attached spheres of calcite at different depths on a mooring deployed and estimated dissolution rates based on weight loss. However, as previously discussed in section 13.2, weight changes may not always be practical as processes other than dissolution may cause changes in mass, and thus, the weight. Nevertheless, in situations where this approach is practical, the buoyant weighing method (section 13.3.4) is appropriate

to monitor changes in weight in living marine calcifiers. This method is also applicable for dead substrates, but in addition, initial and final dry weights may be appropriate if care is taken to clean and dry the substrate prior to measurements. In some instances, dissolution may have a significant and measureable effect on the linear dimensions of the calcareous subject or substrate being investigated (e.g. mussels, oysters, clams). Thus, measuring length, width, and thickness of the organism or substrate using callipers, rulers, image analysis, or similar, may provide valuable data.

Examples of studies that have measured carbonate mineral dissolution based on weight measurements include Walter & Burton (1990), Jokiel *et al.* (2008) and McClintock *et al.* (2009). The strengths of these methods are that they are very simple, inexpensive and do not require any specialised instrumentation and equipment. The weaknesses are that a relatively long duration is required between measurements to detect significant changes (under typical dissolution rates), and that processes other than dissolution such as breakage may result in a change in the mass of the organism or substrate.

### 13.4.4 Image analysis

Image analysis of calcareous skeletons, shells, tests or grains can provide astounding evidence of dissolution, and recently, image analysis software (e.g. NIH image and Scion Image, both available for free online) may allow for quantitative assessment of dissolution or bioerosion processes in certain instances using this approach. Image analysis provides powerful visualisation of the physical and structural implications of mineral dissolution, and combined with chemical and/or weight measurements, it becomes a very strong tool studying dissolution. Depending on the application and the scale of interest, microscopy and scanning electron microscopy (SEM) may be suitable, but even regular photography may be applicable. For investigations looking for a mechanistic understanding of the dissolution process, atomic force microscopy (AFM) and vertical scanning interferometry (VSI) have been used to study carbonate mineral dissolution at the atomic and nano- to micrometer scale, respectively. Both these methods provide quantitative data about the details and the mechanisms of the dissolution process.

Examples of studies that have used image analysis to infer carbonate mineral dissolution include Alexandersson (1975, 1979), Tribollet *et al.* (2002, 2009), Arvidson *et al.* (2003) and McClintock *et al.* (2009). Different instrumentation and analysis tools have different strengths and weaknesses, which depend on the question and application they are used for. In general, imagery at higher magnification provides a sense of the physical implications of dissolution that is otherwise not visible. Recent instrument and software developments may facilitate imagery to be used more and more as a quantitative tool. Weaknesses include that for some applications access to specialised and expensive instrumentation is required and in many instances image data by itself only provides qualitative information about the dissolution process and additional analysis is required.

### 13.5 Strengths and weaknesses

The strengths and weaknesses of each method have been discussed above. In choosing a method one needs to decide if the objective is to establish a baseline rate of net calcification (or dissolution) for a sizeable area under completely natural conditions in which case the alkalinity depletion-residence time method might be most appropriate or if they want to conduct a manipulative study in which case the enclosure or mesocosm approach might be best if the objective is to look at the response of a benthic community to elevated CO<sub>2</sub>. If the objective is to learn how a particular organism will respond to elevated CO<sub>2</sub> or to the combined stress of elevated CO<sub>2</sub> and temperature then one of the organismal scale methods should be considered. If the experimental design involves a single, one-time exposure to one of possibly several combinations of factors, then any of the destructive, organism scale methods is appropriate with the choice depending on the size of the organism. If the experiment involves observing the evolution of the response of a single organism as it is exposed to treatment conditions for an extended period of time (if for instance you are interested in whether the organism has the capacity for acclimation, or if you want to know if the organism can recover if conditions are returned to normal

after varying periods of exposure to stressful conditions) then you will need to use one of the non-destructive organism-scale methods. If you want to look at the kinetics of calcium uptake under ambient and elevated CO<sub>2</sub> then only the <sup>45</sup>Ca method is suitable. If you want a method that can be employed both at the organismal and the community scale so as to facilitate intercomparison then the  $A_T$  method is the right choice.

### 13.6 Potential pitfalls

Experimental design should consider these potential pitfalls:

- Dissolution may occur simultaneously with calcification resulting in underestimation of the true calcification rate and vice versa.
- Net dissolution estimates based on  $A_T$  measurement can be significantly affected by nutrients and sulfate reduction.
- Short-term experiments with organisms may not reflect the long-term response to ocean acidification.
- Early life history stages may exhibit a greater sensitivity to elevated CO<sub>2</sub> than adult stages.
- The response of an organism to elevated CO<sub>2</sub> alone may be quite different than when an organism is simultaneously stressed by a second factor such as temperature.
- Scaling up from individual response to regional ecosystems may be difficult.

### 13.7 Suggestions for improvement

Manipulative studies of the affect of ocean acidification on the calcification of benthic organisms are made difficult by the high variability between seemingly identical individuals. Molecular techniques may be helpful in explaining the basis for the variability in calcification between individuals and provide a way for normalising for that variability. There is a need to improve the ease with which daily, seasonal and annual rates of net calcification (or net dissolution) can be obtained, either by automating the water sample collection process or replacing it through the use of carbonate parameter sensors. We need sensors able to measure  $A_T$  and DIC with a precision and accuracy of  $\pm 2$  to 4  $\mu\text{mol kg}^{-1}$  at the water-seafloor boundary. We need to explore methods for scaling up organismal and 1 kilometer scale transect calcification rates to regional scale rates.

### 13.8 Data reporting

Studies that measure the calcification rate of benthic organisms and the calcification/dissolution of benthic communities should provide clear descriptions of the experimental design and protocols. The precision and accuracy of the measurements of the parameters of the CO<sub>2</sub> system and associated factors (e.g. temperature, salinity, nutrient concentrations) should be reported as well as the constants that were employed to compute any derived CO<sub>2</sub> system parameters. The temperature at which the temperature-dependent CO<sub>2</sub> system parameters (pH, HCO<sub>3</sub><sup>-</sup>, CO<sub>3</sub><sup>2-</sup>, p(CO<sub>2</sub>),  $\Omega_a$ ) were computed must be reported. If pH is reported it is important to report the scale on which it was measured (total scale is highly recommended). If certified reference materials (CRMs) were used to check the accuracy this should be mentioned (highly recommended). If there was a difference between the certified value of the CRM and the measured value, were the data adjusted to correct for the offset? Other experimental conditions that may affect the calcification rate should be reported as appropriate, for example irradiance, light/dark cycle, details about feeding and nutrient concentrations. Studies should describe the location and method of collection of the organisms. For manipulative experiments, if there was an acclimation period, the length and conditions during that period should be described. The mode of chemical manipulation must be described, i.e. acid only, bicarbonate followed by acid or bubbling (see chapter 2). For all but the shortest experiments, the CO<sub>2</sub> system parameters should be reported at the beginning and the end of the experiment. While an investigator may choose to report organismal rates of calcification normalised to protein or the mass of skeleton, they should also be reported per cm<sup>2</sup> of live tissue area because rates in these units are most relatable to field studies. Field based measurements of calcification require reporting of water depth, current speed, community composition (percent cover of the main groups, both calcifiers and non-calcifiers) as well as the usual physical measurements of temperature, salinity, nutrients, irradiance and water clarity.

### 13.9 Recommendations for standards and guidelines

1. Design experiments to maximise statistical power by replicating at the scale of the experimental treatment.
2. Optimise the biomass to volume ratio of the treatment units (aquaria or tanks) for stability of the CO<sub>2</sub> system parameters and for the precision and accuracy of the measured changes in  $A_T$ .
3. If possible, measure other physiological processes because they may provide additional insight.
4. Use CRMs to assure the accuracy of your CO<sub>2</sub> system parameters.
5. Measure and report other environmental conditions that may affect calcification/dissolution rates.
6. Measure both calcification and dissolution rates where possible.
7. Where possible, measure calcification by different methods and compare results – can organismal calcification rates be scaled up and compared with one of the field measurements?

### 13.10 References

- Alexandersson E. T., 1975. Etch patterns on calcareous sediment grains: petrographic evidence of marine dissolution of carbonate minerals. *Science* 189:47-48.
- Alexandersson E. T., 1979. Marine maceration of skeletal carbonates in the Skagerrak, North Sea. *Sedimentology* 26:845-852.
- Aller R. C., 1982. Carbonate dissolution in nearshore terrigenous muds - the role of physical and biological reworking. *Journal of Geology* 90:79-95.
- Andersson A. J., Kuffner I. B., Mackenzie F. T., Jokiel P. L., Rodgers K. S. & Tan A., 2009. Net loss of CaCO<sub>3</sub> from a subtropical calcifying community due to seawater acidification: mesocosm-scale experimental evidence. *Biogeosciences* 6:1811-1823.
- Andersson A. J., Bates N. R. & Mackenzie F. T., 2007. Dissolution of carbonate sediments under rising pCO<sub>2</sub> and ocean acidification: observations from Devil's Hole, Bermuda. *Aquatic Geochemistry* 13:237-264.
- Arvidson R. S., Ertran I. E., Amonette J. E. & Luttge A., 2003. Variation in calcite dissolution rates: a fundamental problem? *Geochimica et Cosmochimica Acta* 67:1623-1634.
- Barnes D. J., 1983. Profiling coral reef productivity and calcification using pH and oxygen electrodes. *Journal of Experimental Marine Biology and Ecology* 66:149-161.
- Barnes D. J. & Devereux M. J., 1984. Productivity and calcification on a coral reef: a survey using pH and oxygen electrode techniques. *Journal of Experimental Marine Biology and Ecology* 79:213-231.
- Berelson W. M., McManus J., Coale K. H., Johnson K. S., Kilgore T., Burdige D. & Pilskaln C., 1996. Biogenic matter diagenesis on the sea floor: A comparison between two continental margin transects. *Journal of Marine Research* 54:731-762.
- Berner R. A., Scott M. R. & Thomlinson C., 1970. Carbonate alkalinity in the pore waters of anoxic marine sediments. *Limnology and Oceanography* 15:544-549.
- Boucher G., Clavier J., Hily C. & Gattuso J.-P., 1998. Contribution of soft-bottoms to the community metabolism (carbon production and calcification) of a barrier reef flat (Moorea, French Polynesia). *Journal of Experimental Marine Biology and Ecology* 225:269-283.
- Brewer P. G. & Goldman J. C., 1976. Alkalinity changes generated by phytoplankton growth. *Limnology and Oceanography* 21:108-117.
- Broecker W. S. & Takahashi T., 1966. Calcium carbonate precipitation on the Bahama Banks. *Journal of Geophysical Research* 71:1575-1602.
- Burdige D. J. & Zimmerman R. C., 2002. Impact of sea grass density on carbonate dissolution in Bahamian sediments. *Limnology and Oceanography* 47:1751-1763.

- Cai W. J., Reimers C. E. & Shaw T., 1995. Microelectrode studies of organic carbon degradation and calcite dissolution at a California continental rise site. *Geochimica et Cosmochimica Acta* 59:497-511.
- Chisholm J. R. M. & Gattuso J.-P., 1991. Validation of the alkalinity anomaly technique for investigating calcification and photosynthesis in coral reef communities. *Limnology and Oceanography* 36:1232-1239.
- Cohen A. L., McCorkle D. C., de Putron S., Gaetani G. A. & Rose K. A., 2009. Morphological and compositional changes in the skeletons of new coral recruits reared in acidified seawater: insights into the biomineralization response to ocean acidification. *Geochemistry, Geophysics, Geosystems* 10, Q07005. doi:10.1029/2009GC002411.
- Cooper T. F., De'ath G., Fabricius K. E. & Lough J., 2008. Declining coral calcification in massive *Porites* in two nearshore regions of the northern Great Barrier Reef. *Global Change Biology* 14:529-538.
- Davies P. S., 1989. Short-term growth measurements of corals using an accurate buoyant weighing technique. *Marine Biology* 101:389-395.
- De'ath G., Lough J. M. & Fabricius K. E., 2009. Declining coral calcification on the Great Barrier Reef. *Science* 323:116-119.
- Dodge R. E., Wyers S. C., Frith H. R., Knap A. H., Smith S. R., Cook C. B. & Sleeter T. D., 1984. Coral calcification rates by the buoyant weight technique: effects of alizarine staining. *Journal of Experimental Marine Biology and Ecology* 75:217-232.
- Falter J. L., Lowe R. J., Atkinson M. J., Monismith S. G. & Schar D. W., 2008. Continuous measurements of net production over a shallow reef community using a modified Eulerian approach. *Journal of Geophysical Research* 113, C07035. doi:10.1029/2007JC004663.
- Gaines A. G. J. & Pilson M. E. Q., 1972. Anoxic water in Pettaquamscutt river. *Limnology and Oceanography* 17:42-49.
- Gattuso J.-P., Frankignoulle M. & Smith S. V., 1999. Measurement of community metabolism and significance of coral reefs in the CO<sub>2</sub> source-sink debate. *Proceedings of the National Academy of Science U.S.A.* 96:13017-13022.
- Gattuso J.-P., Frankignoulle M., Bourge I., Romaine S. & Buddemeier R. W., 1998. Effect of calcium carbonate saturation of seawater on coral calcification. *Global and Planetary Change* 18:37-46.
- Gattuso J.-P., Payri C. E., Pichon M., Delesalle B. & Frankignoulle M., 1997. Primary production, calcification, and air-sea CO<sub>2</sub> fluxes of a macroalgal-dominated coral reef community (Moorea, French Polynesia). *Journal of Phycology* 33:729-738.
- Gattuso J.-P., Pichon M., Delesalle B., Canon C. & Frankignoulle M., 1996. Carbon fluxes in coral reefs. 1. Lagrangian measurement of community metabolism and resulting air-sea CO<sub>2</sub> disequilibrium. *Marine Ecology Progress Series* 145:109-121.
- Gattuso J.-P., Pichon M., Delesalle B. & Frankignoulle M., 1993. Community metabolism and air-sea CO<sub>2</sub> fluxes in a coral reef ecosystem (Moorea, French Polynesia). *Marine Ecology Progress Series* 96:259-267.
- Gazeau F., Quiblier C., Jansen J. M., Gattuso J.-P., Middelburg J. J. & Heip C. H. R., 2007. Impact of elevated CO<sub>2</sub> on shellfish calcification. *Geophysical Research Letters* 34, L07603. doi:10.1029/2006GL028554.
- Gordon D. C. J., Boudreau P. R., Mann K. H., Ong J.-E., Silvert W. L., Smith S. V., Wattayakorn G., Wulff F. & Yanagi T., (Eds.) 1996. LOICZ biogeochemical modelling guidelines *LOICZ Reports & Studies* 5: 1-96.
- Goreau T. F., 1959. The physiology of skeleton formation in corals. I. A method for measuring the rate of calcium deposition by corals under different conditions. *Biological Bulletin* 116:59-75.
- Goreau T. F. & Bowen V. T., 1955. Calcium uptake by a coral. *Science* 122:1188-1189.
- Griffith P. C., Cubit J. D., Adey W. H. & Norris J. N., 1987. Computer-automated flow respirometry: metabolism measurements on a Caribbean reef flat and in a microcosm. *Limnology and Oceanography* 32:442-451.
- Jokiel P., Rodgers K., Kuffner I., Andersson A., Cox E. & Mackenzie F., 2008. Ocean acidification and calcifying reef organisms: a mesocosm investigation. *Coral Reefs* 27:473-483.
- Jokiel P. L. & Coles S. L., 1977. Effects of temperature on the mortality and growth of Hawaiian reef corals. *Marine Biology* 43:201-208.

## Part 3: Measurements of CO<sub>2</sub> - sensitive processes

- Jokiel P. L., Maragos J. E. & Franzisket L., 1978. Coral growth: buoyant weight technique. In: Stoddart D. R. & Johannes R. E. (Eds.), *Coral reefs: research methods*, pp. 379-396. Paris: Unesco.
- Kinsey D. W., 1978a. Alkalinity changes and coral reef calcification. *Limnology and Oceanography* 23:989-991.
- Kinsey D. W., 1978b. Productivity and calcification estimates using slack-water periods and field enclosures. In: Stoddart D. R. & Johannes R. E. (Eds.), *Coral reefs: research methods*, pp. 439-468. Paris: Unesco.
- Langdon C. & Atkinson M. J., 2005. Effect of elevated pCO<sub>2</sub> on photosynthesis and calcification of corals and interactions with seasonal change in temperature/irradiance and nutrient enrichment. *Journal of Geophysical Research - Oceans* 110, C09S07. doi:10.1029/2004JC002576.
- Langdon C., Broecker W. S., Hammond D. E., Glenn E., Fitzsimmons K., Nelson N. G., Peng T.-H., Hajdas I. & Bonani G., 2003. Effect of elevated CO<sub>2</sub> on the community metabolism of an experimental coral reef. *Global Biogeochemical Cycles* 17, 1001. doi:10.1029/2002GB001941.
- Langdon C., Takahashi T., Marubini F., Atkinson M., Sweeney C., Aceves H., Barnett H., Chipman D. & Goddard J., 2000. Effect of calcium carbonate saturation state on the rate of calcification of an experimental coral reef. *Global Biogeochemical Cycles* 14:639-654.
- Leclercq N., Gattuso J.-P. & Jaubert J., 2002. Primary production, respiration, and calcification of a coral reef mesocosm under increased CO<sub>2</sub> partial pressure. *Limnology and Oceanography* 47:558-564.
- Leclercq N., Gattuso J.-P. & Jaubert J., 2000. CO<sub>2</sub> partial pressure controls the calcification rate of a coral community. *Global Change Biology* 6:329-334.
- Mackenzie F. T., Lerman A. & Andersson A. J., 2004. Past and present of sediment and carbon biogeochemical cycling models. *Biogeosciences* 1:11-32.
- Marsh J. A. & Smith S. V., 1978. Productivity measurements of coral reefs in flowing water. In: Stoddart D. R. & Johannes R. E. (Eds.), *Coral reefs research methods*, pp. 361-377. Paris: Unesco.
- Marubini F., Barnett H., Langdon C. & Atkinson M. J., 2001. Dependence of calcification on light and carbonate ion concentration for the hermatypic coral *Porites compressa*. *Marine Ecology Progress Series* 220:153-162.
- Marubini F., Ferrier-Pagès C. & Cuif J.-P., 2003. Suppression of skeletal growth in scleractinian corals by decreasing ambient carbonate-ion concentration: a cross-family comparison. *Proceedings of the Royal Society of London. Series B: Biological Sciences* 270:179-184.
- Marubini F., Ferrier-Pagès C., Furla P. & Allemand D., 2008. Coral calcification responds to seawater acidification: a working hypothesis towards a physiological mechanism. *Coral Reefs* 27:491-499.
- McClintock J. B., Angus R. A., McDonald M. R., Amsler C. D., Catledge S. A. & Vohra Y. K., 2009. Rapid dissolution of shells of weakly calcified Antarctic benthic macroorganisms indicates high vulnerability to ocean acidification. *Antarctic Science* 21:449-456.
- Migné A., Davoult D. & Gattuso J.-P., 1998. Calcium carbonate production of a dense population of the brittle star *Ophiothrix fragilis* (Echinodermata: Ophiuroidea): role in the carbon cycle of a temperate coastal ecosystem. *Marine Ecology Progress Series* 173:305-308.
- Miller A. W., Reynolds A. C., Sobrino C. & Riedel G. F., 2009. Shellfish face uncertain future in high CO<sub>2</sub> world: influence of acidification on oyster larvae calcification and growth in estuaries. *PLoS ONE* 4:e5661. doi:10.1371/journal.pone.0005661#abstract0.
- Morse J. W., Arvidson R. S. & Luttge A., 2007. Calcium carbonate formation and dissolution. *Chemical Reviews* 107:342-381.
- Morse J. W. & Mackenzie F. T., 1990. *Geochemistry of sedimentary carbonates*. 707 p. Amsterdam: Elsevier.
- Odum H. T., 1956. Primary production in flowing waters. *Limnology and Oceanography* 1:102-117.
- Ohde S. & Hossain M. M. M., 2004. Effect of CaCO<sub>3</sub> (aragonite) saturation state of seawater on calcification of *Porites* coral. *Geochemical Journal* 38:613-621.
- Pari N., Peyrot Clausade M. & Hutchings P. A., 2002. Bioerosion of experimental substrates on high islands and atoll lagoons (French Polynesia) during 5 years of exposure. *Journal of Experimental Marine Biology and Ecology* 276:109-127.



- Peterson M. N., 1966. Calcite: rates of dissolution in a vertical profile in the Central Pacific. *Science* 154:1542-1544.
- Renegar D. A. & Riegl B. M., 2005. Effect of nutrient enrichment and elevated CO<sub>2</sub> partial pressure on growth rate of Atlantic scleractinian coral *Acropora cervicornis*. *Marine Ecology Progress Series* 293:69-76.
- Reynaud S., Leclercq N., Romaine-Lioud S., Ferrier-Pagès C., Jaubert J. & Gattuso J.-P., 2003. Interacting effects of CO<sub>2</sub> partial pressure and temperature on photosynthesis and calcification in a scleractinian coral. *Global Change Biology* 9:1660-1668.
- Ridgwell A. J., Kennedy M. J. & Caldeira K., 2003. Carbonate deposition, climate stability, and Neoproterozoic ice ages. *Science* 302:859-862.
- Ries J. B., Cohen A. L. & McCorkle D. C., 2009. Marine calcifiers exhibit mixed responses to CO<sub>2</sub>-induced ocean acidification. *Geology* 37:1131-1134.
- Schneider K. & Erez J., 2006. The effect of carbonate chemistry on calcification and photosynthesis in the hermatypic coral *Acropora eurystoma*. *Limnology and Oceanography* 51:1284-1293.
- Silverman J., Lazar B. & Erez J., 2007. Effect of aragonite saturation, temperature, and nutrients on the community calcification rate of a coral reef. *Journal of Geophysical Research* 112, C05004. doi:10.1029/2006JC003770.
- Smith S. V., 1972. Production of calcium carbonate on the mainland shelf of Southern California. *Limnology and Oceanography* 17:28-41.
- Smith S. V., 1995. Reflections on the measurement and significance of carbon metabolism on coral reefs. *Kansas Geological Survey Open-File Report Series* 95-56:1-18.
- Smith S. V. & Jokiel P. L., 1978. Water composition and biogeochemical gradients in the Canton atoll lagoon. *Atoll Research Bulletin* 221:16-53.
- Smith S. V. & Key G. S., 1975. Carbon dioxide and metabolism in marine environments. *Limnology and Oceanography* 20:493-495.
- Smith S. V. & Pesret F., 1974. Processes of carbon dioxide flux in the Fanning Island lagoon. *Pacific Science* 28:225-245.
- Smith S. V., 1978. Alkalinity depletion to estimate the calcification of coral reefs in flowing waters. In: Stoddard D. R. & Johannes R. E. (Eds.), *Coral reefs: research methods*, pp. 397-404. Paris: Unesco.
- Stimson J. & Kinzie R. A., 1991. The temporal pattern and rate of release of zooxanthellae from the reef coral *Pocillopora damicornis* (Linnaeus) under nitrogen-enrichment and control conditions. *Journal of Experimental Marine Biology and Ecology* 153:63-74.
- Tambutté É., Allemand D., Bourge I., Gattuso J.-P. & Jaubert J., 1995. An improved <sup>45</sup>Ca protocol for investigating physiological mechanisms in coral calcification. *Marine Biology* 122:453-459.
- Tanzil J. T. I., Brown B. E., Tudhope A. W. & Dunne R. P., 2009. Decline in skeletal growth of the coral *Porites lutea* from the Andaman Sea, South Thailand between 1984 and 2005. *Coral Reefs* 28:519-528.
- Tribble G. W., Sansone F. J. & Smith S. V., 1990. Stoichiometric modeling of carbon diagenesis within a coral reef framework. *Geochimica et Cosmochimica Acta* 54:2439-2449.
- Tribollet A., 2008. The boring microflora in modern coral reef ecosystems: a review of its roles. In: Wisshak M. & Tapanila L. (Eds.), *Current developments in bioerosion*, pp. 67-94. Heidelberg: Springer-Verlag.
- Tribollet A., Atkinson M. J. & Langdon C., 2006. Effects of elevated pCO<sub>2</sub> on epilithic and endolithic metabolism of reef carbonates. *Global Change Biology* 12:2200-2208.
- Tribollet A., Decherf G., Hutchings P. A. & Peyrot-Clausade M., 2002. Large-scale spatial variability in bioerosion of experimental coral substrates on the Great Barrier Reef (Australia): importance of microborers. *Coral Reefs* 21:424-432.
- Tribollet A., Godinot C., Atkinson M. & Langdon C., 2009. Effects of elevated pCO<sub>2</sub> on dissolution of coral carbonates by microbial euendoliths. *Global Biogeochemical Cycles* 23, GB3008. doi:10.1029/2008GB003286.
- Walter L. M. & Burton E. A., 1990. Dissolution of recent platform carbonate sediments in marine pore fluids. *American Journal of Science* 290:601-643.

## Part 3: Measurements of CO<sub>2</sub> -sensitive processes

- Walter L. M. & Morse J. W., 1984. Reactive surface area of skeletal carbonates during dissolution: effect of grain size. *Journal of Sedimentary Petrology* 54:1081-1090.
- Walter L. M. & Morse J. W., 1985. The dissolution kinetics of shallow marine carbonates in seawater: a laboratory study. *Geochimica et Cosmochimica Acta* 49:1503-1513.
- Yates K. K. & Halley R. B., 2003. Measuring coral reef community metabolism using new benthic chamber technology. *Coral Reefs* 22:247-255.
- Yates K. K. & Halley R. B., 2006. CO<sub>3</sub><sup>2-</sup> concentration and pCO<sub>2</sub> thresholds for calcification and dissolution on the Molokai reef flat, Hawaii. *Biogeosciences* 3:357-369.
- Zeebe R. E. & Wolf-Gladrow D. A., 2001. *CO<sub>2</sub> in seawater: equilibrium, kinetics, isotopes*. 346 p. Amsterdam: Elsevier.

### 14 Modelling considerations

Andreas Oschlies<sup>1</sup>, Jeremy Blackford<sup>2</sup>, Scott C. Doney<sup>3</sup> and Marion Gehlen<sup>4</sup>

<sup>1</sup>Leibniz Institute of Marine Sciences (IFM-GEOMAR), Marine Biogeochemistry, Germany

<sup>2</sup>Plymouth Marine Laboratory, UK

<sup>3</sup>Marine Chemistry and Geochemistry Dept., Woods Hole Oceanographic Institution, USA

<sup>4</sup>Laboratoire des Sciences du Climat et de l'Environnement (LSCE), France

#### 14.1 Introduction

Numerical models can be viewed as a simplified representation of the real world. They comprise a system of rules that are combined with a number of initial conditions (e.g. nutrient distribution) and boundary conditions (e.g. atmospheric forcing) to make inferences about the state of affairs. A very similar procedure takes place when interpreting observations or planning experiments: the readings of instruments are translated following a set of rules into biogeochemically relevant properties; these are then arranged into a coherent picture in the mind of the scientist. Numerical models require that the rules be represented in a formal mathematical description, which has, at least in theory, the advantage of a clear and unambiguous language that should help to make models transparent and portable between different investigators. Another advantage is that the numerical model formulation requires the quantitative comparison of different parts of the system. Conceptual models developed from empirical or phenomenological considerations can take us only so far, and we often learn considerably more about the system when quantitative comparisons of, say, the balance of terms for an element do not agree.

Numerical models can be used to put data of different quality, isolated in space and in time, into a coherent context. This process can benefit from the concept of data assimilation that aims at a most efficient combination of information contained in the data with information contained in the model's rules. However, the complex theoretical and operational apparatus of data assimilation has, so far, limited its application. Probably the most widespread applications of numerical models are to explore logical consequences of hypotheses ("what if" experiments) and to identify sensitivities of integral properties to individual processes. The former category includes scenario simulation into the future. An important point to make about models is that, with a few exceptions, they cannot make predictions or insights about phenomenon that are not at some level included in the set of rules defining the model equations. In this respect models are intimately tied to laboratory and field work. The "what if" scenarios are only as good as the set of rules, and these scenarios typically are working on known (if only poorly) processes.

Numerical models can basically address the same kind of scientific questions as other scientific methods. In this respect, models are just another tool, comparable to, for example, mass spectrometry. However, models have a unique ability to firstly test our synthesised understanding of a given system and secondly extrapolate in time or space to regions where data is sparse. Calibrated model results can identify problems with our underlying conceptual understanding and highlight observational and experimental needs. Further, models can identify the perturbation envelope for experimental activities, for example pH and  $\Omega$  ranges, and identify sensitive areas (e.g. the Arctic). Model results can also contribute to the identification of new hypotheses that require testing by data. Consequently, scientists who develop and apply models should not be viewed as potential "end-users" of experiments or observational campaigns. Models, as well as field and laboratory experiments should rather be designed in conjunction with each other, building on the strengths of the different techniques.

Predictive models are, in general, one of the key methods for synthesising understanding into a format usable by decision- and policymakers. Indeed, the recent emergence of climate change as a mainstream issue, which depends to a large extent on climate model scenario simulations, has enabled the far more rapid recognition

of ocean acidification as a parallel concern for policymakers. Consequently, the scientific community is being challenged to produce robust and relevant science that underpins international policy development on a relatively short timescale. However, whilst prediction of the carbonate system response is reasonably robust (e.g. Caldeira & Wickett, 2003; Orr *et al.*, 2005), predicting the response of ecosystems and resources is problematic and is at a very early stage (for example Blackford & Gilbert, 2007; Bourret *et al.*, 2007; Hashioka & Yamanaka, 2007). This is due in part to the complexity of system drivers and in part to the range of effects identified and the variety of responses of different species, phyla etc. Hence, a translation of results into policy poses several problems for modellers.

### 14.2 Approaches and methodologies

In contrast to ocean circulation models that rely on the well-established Newton's laws, there are no known fundamental equations that govern marine ecosystems. There is not even consensus on biological invariants that may be used as prognostic variables of a marine ecosystem model. Traditionally, most biogeochemical models and lower-trophic planktonic ecosystem models partition the ecosystem into nutrients, phytoplankton, zooplankton, and non-living particulate and dissolved organic matter, but the more detailed level information on species and the full suite of biological/ecological dynamics needed to address particular questions, such as ocean acidification, cannot always be easily mapped onto this traditional picture. One approach is to make models more complex, for example by adding multiple plankton functional types (PFT models). No model, simple or complex, has yet demonstrated a fully successful reproduction of observed global patterns and temporal variations of biomass or of biogeochemical tracers such as nutrients, carbon, oxygen and total alkalinity within the observational uncertainty. This does not only reflect the yet oversimplified description of biological drivers, but is also attributed to the representation of ocean physics.

It is noteworthy that increased complexity comes at the cost of having to constrain more model parameters (e.g. growth rates, mortality rates, grazing rates), about which we have only very limited information. Moreover, the spread of the biogeochemical function "calcification" across auto- and heterotrophic organisms, as well as the variety of species-specific responses to acidification found in calcifying species (e.g. Fabry, 2008), makes a generic PFT type parameterisation problematic. A further complication is that it is unclear how such models (as well as simpler models) could adequately describe adaptation to environmental changes. Promising new modelling approaches include trait-based models in aquatic ecology. These new models let the ecosystem self-assemble from a large number of species, and biodiversity, and to some extent adaptation, can be emergent features of such models (Norberg *et al.*, 2001; Bruggeman & Kooijman, 2007; Follows *et al.*, 2007). An exhaustive quantitative comparison against field observations has not been done for such models. While these approaches raise additional parameterisation problems in terms of the rule choices for the energetic and metabolic trade-offs, the number of parameters to be set by the person running the model is expected to be smaller than for multiple PFT models.

So far, there are broadly two types of modelling approaches. In the first approach, one attempts to build models based on mechanistic principles, i.e. some reasonably correct representation of physiological and biogeochemical processes that describe the exchange of matter and energy among the different compartments of an ecosystem model. In the other approach, one uses empirical relationships derived from culture, mesocosm or observational studies, and sometimes results from statistical regressions of simple functional relationships against measurements. A subset of the latter, empirical, category include remote sensing algorithms, that contribute valuable information on biological variability (e.g. productivity, calcifier biomass and biomineralisation rates) and when combined with physical data may be useful for interpolating surface water chemistry in space and time (Gledhill *et al.*, 2008). The former, mechanistic, approach has the disadvantage of requiring possibly many parameters (not all of which can be constrained without becoming empirical again), but there is no *a priori* reason why such models cannot be used in predictive mode, as long as the changing drivers are correctly described and incorporated into the process descriptions. The empirical approach is often unsuitable for making

predictions as, in general, the sensitivity of these relationships to environmental change, such as warming or acidification, has not fully been established and can therefore not be properly accounted for by the models. A notable exception is empirical models based on observations that encompass future variability of environmental conditions by either considering past and present natural variability or perturbation experiments.

The seawater carbonate system is, in contrast, well constrained. Equilibrium constants are well known, and although there are variations in particular constants emerging from different studies, a consistent and robust approach is generally possible (e.g. Zeebe & Wolf-Gladrow, 2001; Dickson *et al.*, 2007). Typically models use measured dissolved inorganic carbon concentration and measured or estimated total alkalinity as the master variables from which pH,  $p(\text{CO}_2)$ , concentrations of bicarbonate and carbonate and saturation state of different carbonate minerals are calculated. On ocean basin scales this approach is reasonably robust, and total alkalinity can be derived from salinity according to a number of basin-specific linear relationships. Unfortunately, these relationships are at best approximate in shelf seas, where total alkalinity is influenced by significant biological and riverine signals, coupled with high spatial and temporal heterogeneity (Friis *et al.*, 2003; Thomas *et al.*, 2008). These processes are also susceptible to change (e.g. riverine total alkalinity; Raymond & Cole, 2003) and potential changes must be factored into predictive scenarios. It is recommended that total alkalinity be included in biogeochemical ocean circulation models as prognostic tracer rather than being diagnosed from empirical fits to salinity.

With respect to the production of biogenic particulate inorganic carbon (PIC), which in models is usually associated with calcite (disregarding other carbonate minerals), a large variety of parameterisations have been used. Many models assume that PIC production is proportional to primary production or export production, thereby emphasising the role of the  $\text{CaCO}_3$  cycle in the Earth system. This is fundamentally different from an attempt to assess impacts on the ecosystem level. These parameterisations are often independent of the carbonate chemistry (e.g. Moore *et al.*, 2002; Schmittner *et al.*, 2008). Some models take into account a control of PIC production by the carbonate chemistry (Heinze, 2004; Gehlen *et al.*, 2007; Ridgwell *et al.*, 2007) though different models use different controls (pH,  $\text{CO}_2$ ,  $\text{CO}_3^{2-}$ ,  $\Omega$ ) and different functional forms (linear, sigmoid, power law) describing either PIC production or the ratio of PIC to POC (particulate organic carbon) production. While some of the variables describing the carbonate system are temperature dependent, some models explicitly or, via primary production, implicitly include a temperature dependence in the parameterisation of the PIC production. Most models either explicitly or implicitly assign  $\text{CaCO}_3$  production to photosynthetic coccolithophores and do not yet try to capture  $\text{CaCO}_3$  production by zooplankton (foraminifera, pteropods). An early example considering zooplankton together with a consideration of the difference in mineralogy (pteropod aragonite) is the study of Gangstø *et al.* (2008).

The different parameterisations of PIC production and its sensitivities to changes in temperature and carbonate chemistry can lead to very different results. When applied to a global warming scenario, different models may even predict different signs in the change of PIC production. For example, a business-as-usual emission scenario leads to a ( $\text{CO}_2$  driven) reduction of PIC production over the next few hundred years in the model of Heinze (2004), whereas essentially the same scenario leads to a (temperature-driven) increase in PIC production in the model of Schmittner *et al.* (2008). The former model run neglects warming effects and assumes a linear relationship between PIC production and  $\text{CO}_2$ , the later model assumes no direct impact of the carbonate chemistry on PIC production, but includes a temperature effect. Gangstø *et al.* (2008) include a combination of both global warming and  $\text{CO}_2$  effects and predict an overall reduction of PIC production. To the authors' knowledge, model parameterisations have not yet been tested against experimental data sets that yield information about the combined effect of warming and acidification on calcium carbonate production and dissolution. These data sets are currently becoming available and will allow an evaluation of model parameterisations in the near future.

Ocean acidification will also affect the vertical transport and remineralisation of PIC and will thus alter the distributions of total alkalinity and dissolved inorganic carbon. Abiotic carbonate dissolution

rates increase non-linearly as saturation states decline below 1. The upward shoaling of the saturation horizon will therefore decrease the depth at which sinking particles begin to dissolve in the water column. Changes in euphotic zone biological populations and community composition also could alter particle size distributions and sinking speeds as could changes in the structure and function of mesopelagic food webs. Presently, many biogeochemical models use relatively simple, non-mechanistic parameterisations for organic and inorganic particle remineralisation such as fixed exponential length scales or power laws that are independent of seawater chemistry.

Other implications of acidification are relevant to element cycling and ecological questions. Phytoplankton functional groups have varying sensitivities to  $\text{CO}_2$  availability (Tortell *et al.*, 2002, 2008; Rost *et al.*, 2003), with studies showing a shift away from calcifiers to diatoms at low pH and elevated  $\text{CO}_2$ . Nutrient speciation, nitrification (Huesemann *et al.*, 2002) and nitrogen fixation (Hutchins *et al.*, 2007; Levitan *et al.*, 2007) are all sensitive to pH and/or  $\text{CO}_2$ . Nutrient uptake stoichiometry may be affected by changes in community composition and vice versa. Phytoplankton uptake and export C:N ratios have also been shown to be  $\text{CO}_2$  sensitive (Riebesell *et al.*, 2007). These processes are generally not included in present generation models, apart from specific sensitivity studies (e.g. Oschlies *et al.*, 2008).

A much wider range of models may need to be involved for fully assessing the biological impacts of ocean acidification. These could include high-resolution regional models applied to questions on open ocean eddies, coastal dynamics or coral reefs. Models of higher trophic levels will be required with more detailed life histories of specific organisms (e.g. larvae of molluscs, crustaceans, finfish). Higher trophic levels are often treated via individual-based models that track individual organisms (or groups of organisms), compute biological interactions and responses as a function of time and space along the Lagrangian particle trajectory, and incorporate behaviour (e.g., vertical migration, swarming). Other useful types of models are those oriented towards marine resource management (fisheries) and conservation (e.g. corals, biodiversity), and models of socio-economic processes and ecosystem services.

### 14.3 Strengths and weaknesses

A strength of numerical models is their purely mathematical description. In principle, the clarity of this “language” should leave no room for ambiguities. However, modern numerical models have become more and more complex, culminating in several tens to hundreds of thousands lines of code for current coupled carbon-climate models. One issue is code errors, the bane of existence for numerical models. Another issue is the coupling of distinct processes required for studying system dynamics. As a result, the behaviour of any particular parameterisation in a model is sensitive to the behaviour of many other parameterisations, often in ways that are non-intuitive until the actual coupling is conducted. A normal user of such models will not be able to carefully read through and understand the entire code, and careful checks are needed to establish with confidence that newly added model components work correctly when combined with the rest of the code. Biogeochemical tracers are, for example, not only affected by the biotic source or sink terms. They are also affected by physical transport processes such as advection, diapycnal mixing, isopycnal mixing, sometimes air-sea exchange, dilution by rain or river run-off, or sinking of particles. Although exact equations for fluid motion are available (the Navier-Stokes equations), one cannot resolve all of the important time and space scales and therefore needs to rely on subgrid-scale parameterisations for processes such as mixing and air-sea exchange. All these processes are commonly dealt with in different subroutines at different locations of the complex code. A common model user will, in general, not want to or not be able to go into the details of all these code parts. This is general scientific practice (not many experimentalists will know everything about the components of their measurement devices), but any flaws in the code parts or in the way they are combined may significantly affect the simulated biogeochemical tracer distributions. Apart from mass conservation, no generally accepted biogeochemical model tests are available, and the appropriate model setup will depend on the experience and prudence of the individual modeller.

Acidification is not the only factor with implications for the marine system, and processes sensitive to ocean acidification are likely to be affected also by climate change (changes in temperature, surface fluxes, transport, light, mixing and species interactions) and direct anthropogenic drivers such as fishing and eutrophication. This complexity underlines the utility of a modelling approach that has the potential to address multiple drivers, particularly as the strongly non-linear interaction of these vectors and the non equilibrium state of marine ecosystems make empirical/statistical based predictions questionable. For example, physical processes sensitive to climate change induce variability in the carbonate system (i.e. latitudinally, Orr *et al.* (2005) or due to upwelling, Feely *et al.* (2008)). Altered regional rainfall patterns which, along side changes in land use and industrial processes, will modify fluvial inputs to coastal systems affecting nutrients, optical properties, dissolved inorganic carbon and total alkalinity (Raymond & Cole, 2003; Gypens *et al.*, 2009). Species and communities are likely to shift their geographic ranges as temperatures increase (e.g. Beaugrand *et al.*, 2002), introducing different phenologies, acidification sensitivities and trophic transfer potential. There are also processes and systems directly affected by both temperature and acidification. Coral calcification is vulnerable to both thermal stress from climate change and lowering saturation states driven by acidification (e.g. Reynaud *et al.*, 2003) and sensitivity to nutrient concentrations has also been identified (Langdon & Atkinson, 2005). There is also clear evidence that combined CO<sub>2</sub> and temperature stress induces amplified effects on higher trophic level organisms (Pörtner *et al.*, 2005; Pörtner & Knust, 2007; Pörtner & Farrell, 2008).

#### 14.4 Potential pitfalls

Numerical models are written in computer languages that must be translated by machine-specific compilers into machine-readable commands. As a matter of fact, the same model may yield different results when run on different computers or even on different CPUs (central processing units) of the same computer. Usually, these differences are small, for example rounding errors at the last digit. For properly written codes this should not significantly affect the results of the simulation. Another issue are compilers, themselves computer codes with possible errors, that have different “risk options” with higher risks often being very attractive as they lead to faster performance of the code. Model results obtained under different “risk options” are often different. It is generally hoped, but rarely shown, that these differences do not significantly affect the model results.

A second issue arises when converting model equations from the continuous or analytical form into discretised form and then solving those discretised equations using numerical methods. Some care has to be taken to ascertain that the solution algorithm (e.g. Euler, Runge-Kutta, etc.), in combination with the choice of time and space discretisation schemes, does not lead to unacceptably large numerical errors. Many climate models have built-in checks for some stability criteria for the simulation of fluid flow, but biogeochemical and ecological model components often resort to pragmatic algorithms (for example, Euler forward in time, clipping of spurious negative tracer concentrations). It is hoped and expected that such issues are of minor importance for the model solution, but this is rarely shown nor is it evident for the often highly nonlinear systems.

Numerical tracer advection schemes are required for all models with spatial dimensions, and these numerical approximations can introduce artificial extrema or, alternatively, overly smooth simulated tracer fields. The choice of advection scheme can have substantial impacts on chemical and biological tracers, particularly in regions with sharp spatial gradients. This can be especially troublesome near the surface where numerical errors can lead to unphysical, negative tracer values. While no advection scheme can fully meet all desired metrics, new higher-order methods are available that provide decent compromises at reasonable computational cost.

Conceptual pitfalls are that we very likely miss some key physiological effects at the organism level in our models. For example, mechanistic descriptions of biogenic calcification or of the sensitivities of different

zooplankton life stages or fish larvae to changes in carbonate chemistry are not yet available. Furthermore, food web dynamics is not understood well enough to propagate impacts on one trophic level or specific taxonomic groups (say pteropods or cold-water corals) to higher trophic levels and the whole ecosystem.

### 14.5 Suggestions for improvements

It is vital that the entire model code used in publications is archived and available so that experiments can be repeated. Many journals now explicitly allow for electronic supplementary material; others like the new open access journal *Geoscientific Model Development* encourage publication of model descriptions. A minimum requirement should be the publication of the mathematical equations used in the respective model. From a biogeochemist's viewpoint this should be the biogeochemical source and sink terms of any coupled carbon-climate model. However, it should be kept in mind that apparent details such as the algorithms used to transport tracers may turn out to be significant for the model results, as are the initial conditions, forcing data and computational details. Similar to laboratory logbooks used in experimental work, it is good practice, and recommended here, to archive the entire source code, make files, compiler options, operating system and machine version used to obtain the published results. Testing of models or model components by others in the form of collaborative projects is encouraged, as this promotes two-way knowledge exchange.

Evaluation of models is a pre-requisite for establishing (un)certainty and model utility. Far too little attention has historically been paid to evaluation (Arhonditsis & Brett, 2004) and many publications still do not consider model correctness with any acceptable detail. One particular practice is to rely solely on visual comparisons, which have no quantitative basis. Formal evaluation metrics are readily available (Doney *et al.*, 2009; Stow *et al.*, 2009) and these provide an ability to gauge model improvements and to identify process, spatial or temporal problems with model construct. Other multivariate techniques (e.g. Allen & Somerfield, 2009) provide an ability to test the emergent properties of a model, for example whether the relationships between key variables in the model replicate those in the observations. This approach can be useful in dynamic systems where the model setup is rarely able to exactly mimic events in space or time because of, say, a lack of accuracy in underlying physical models or boundary conditions, but the essential dynamics of the ecosystem model is potentially reasonable.

Evaluation can take many forms. Where observations are sparse, an evaluation of process descriptions is useful. In particular, forecast scenarios that clearly cannot be evaluated *per se*, can be evaluated in a hindcast simulation. Evaluation can also be addressed as a stand-alone publication, which allows sufficiently detailed treatment, especially for complex model systems (e.g. Holt *et al.*, 2005; Lewis *et al.*, 2006; Allen *et al.*, 2007).

Despite driver uncertainties in marginal seas, the carbonate system is well constrained. Therefore an absolute requirement for models is the correct treatment of the carbonate system. Standard CO<sub>2</sub> system model code is publically available through the Ocean Carbon-Cycle Model Intercomparison Project (OCMIP) web site (<http://www.ipsl.jussieu.fr/OCMIP/>). The user should refer to the most recent developments.

A concern is the obvious lack of biological detail in global or earth system models and the less obvious identification of the level of model complexity needed to answer the respective scientific question. Whilst complexity is often limited by computational systems and important feedback mechanisms are likely to be omitted, more complex models tend to be much more difficult to understand and to calibrate. There is a case for stronger iteration with regional, ecologically complex models that may be better constrained by the available data sets than global models and that may help to identify important processes that could be tested in global simulations. In particular, variable stoichiometry (carbon to nutrients, carbon to chlorophyll) is being identified as an important quality of marine ecosystem models.

The use of model results for policymaking requires some care. For example, the highly variable predictions of warming from climate models initially created uncertainty in public and policy response, which may have



undermined the speed with which climate change became globally recognised. In this respect, the IPCC approach to use a probabilistic reporting envelope is highly valuable (despite inherent problems of such a probabilistic description; Betz, 2007), as are the coherent scientific summaries from the “Oceans in a High CO<sub>2</sub> World” symposiums for example. Still, understanding uncertainty and rigorous evaluations are vital components for robust science. This specifically holds for the use of models. Although each model simulation is usually deterministic, i.e., it will report a unique answer for a given scenario, uncertainty comes into play via initial and boundary conditions (in particular the considerable uncertainty in future CO<sub>2</sub> emissions), via our incomplete knowledge of the governing natural laws, and via uncertainty in the parameter values that are used in the model equations. In addition, ensemble approaches, which explore say parameter or driver uncertainty and deliver a probabilistic conclusion, are valuable as are model–model intercomparison exercises that explore apparent disagreements in results.

#### 14.6 Data reporting

The archiving of model output has to follow the general rules outlined with respect to data and metadata reporting and archiving outlined in chapter 15. Similar to protocols used in experimental work, it is therefore good practice to archive the entire code, make files, and compiler options used to obtain the published results.

#### 14.7 Recommendations for standards and guidelines

1. Report all equations, parameterisations and parameter values used in publications
2. Model code must be archived, ideally under version control. If possible, it should be made publicly available.
3. Carbonate chemistry must be correctly calculated (the most recent OCMIP protocol is recommended: <http://www.ipsl.jussieu.fr/OCMIP/>)
4. Models must be evaluated against observations and their uncertainty documented and accounted for when drawing conclusions.
5. Ongoing data compilation and synthesis efforts are needed for model evaluation; they must be pursued and amplified. For example, data sets of seasonal changes and secular trends in carbonate chemistry, distribution and rate of calcification and biological responses to seawater chemistry are very useful. A good example is the EPOCA/EUR-OCEANS data compilation project (<http://www.epoca-project.eu/index.php/What-do-we-do/Science/Data.html>).
6. New targeted laboratory mesocosms and field perturbation experiments should be conducted to test and improve the functional form and parameters for parameterising biological processes.

#### 14.8 References

- Allen J. I., Holt J. T., Blackford J. & Proctor R., 2007. Error quantification of a high-resolution coupled hydrodynamic-ecosystem coastal-ocean model: Part 2. Chlorophyll-a, nutrients and SPM. *Journal of Marine Systems* 68:381-404.
- Allen J. I. & Somerfield P. J., 2009. A multivariate approach to model skill assessment. *Journal of Marine Systems* 76:83-94.
- Arhonditsis G. B. & Brett M. T., 2004. Evaluation of the current state of mechanistic aquatic biogeochemical modeling. *Marine Ecology Progress Series* 271:13-26.
- Beaugrand G., Reid P. C., Ibanez F., Lindley J. A. & Edwards M., 2002. Reorganization of North Atlantic marine copepod biodiversity and climate. *Science* 296:1692-1694.

- Betz G., 2007. Probabilities in climate policy advice: a critical comment. *Climatic Change* 85:1-9.
- Blackford J. C. & Gilbert F. J., 2007. pH variability and CO<sub>2</sub> induced acidification in the North Sea. *Journal of Marine Systems* 64:229-241.
- Bourret A., Martin Y. & Troussellier M., 2007. Modelling the response of microbial food web to an increase of atmospheric CO<sub>2</sub> partial pressure in a marine Mediterranean coastal ecosystem (Brusc Lagoon, France). *Ecological Modelling* 208:189-204.
- Bruggeman J. & Kooijman S. A. L. M., 2007. A biodiversity-inspired approach to aquatic ecosystem modeling. *Limnology and Oceanography* 52:1533-1544.
- Caldeira K. & Wickett M., 2003. Anthropogenic carbon and ocean pH. *Nature* 425:365.
- Dickson A. G., Sabine C. L. & Christian J. R. (Eds.), 2007. Guide to best practices for ocean CO<sub>2</sub> measurements. *PICES Special Publication* 3:1-191.
- Doney S. C., Lima I., Moore J. K., Lindsay K., Behrenfeld M. J., Westberry T. K., Mahowald N., Glover D. M. & Takahashi T., 2009. Skill metrics for confronting global upper ocean ecosystem-biogeochemistry models against field and remote sensing data. *Journal of Marine Systems* 76:95-112.
- Fabry V. J., 2008. Ocean science - marine calcifiers in a high-CO<sub>2</sub> ocean. *Science* 320:1020-1022.
- Feely R. A., Sabine C. L., Hernandez-Ayon J. M., Ianson D. & Hales B., 2008. Evidence for upwelling of corrosive "acidified" water onto the continental shelf. *Science* 320:1490-1492.
- Follows M. J., Dutkiewicz S., Grant S. & Chisholm S. W., 2007. Emergent biogeography of microbial communities in a model ocean. *Science* 315:1843-1846.
- Friis K., Körtzinger A. & Wallace D. W. R., 2003. The salinity normalization of marine inorganic carbon chemistry data. *Geophysical Research Letters* 30, 1085. doi:10.1029/2002GL015898.
- Gangstø R., Gehlen M., Schneider B., Bopp L., Aumont O. & Joos F., 2008. Modeling the marine aragonite cycle: changes under rising carbon dioxide and its role in shallow water CaCO<sub>3</sub> dissolution. *Biogeosciences* 5:1057-1072.
- Gehlen M., Gangstø R., Schneider B., Bopp L., Aumont O. & Ethe C., 2007. The fate of pelagic CaCO<sub>3</sub> production in a high CO<sub>2</sub> ocean: a model study. *Biogeosciences* 4:505-519.
- Gledhill D. K., Wanninkhof R., Millero F. J. & Eakin M., 2008. Ocean acidification of the Greater Caribbean Region 1996-2006. *Journal of Geophysical Research - Oceans* 113, C10031. doi:10.1029/2007JC004629.
- Gypens N., Borges A. V. & Lancelot C., 2009. Effect of eutrophication on air-sea CO<sub>2</sub> fluxes in the coastal Southern North Sea: a model study of the past 50 years. *Global Change Biology* 15:1040-1056.
- Hashioka T. & Yamanaka Y., 2007. Ecosystem change in the western North Pacific associated with global warming using 3D-NEMURO. *Ecological Modelling* 202:95-104.
- Heinze C., 2004. Simulating oceanic CaCO<sub>3</sub> export production in the greenhouse. *Geophysical Research Letters* 31, L16308. doi:10.1029/2004GL020613.
- Holt J. T., Allen J. I., Proctor R. & Gilbert F., 2005. Error quantification of a high-resolution coupled hydrodynamic-ecosystem coastal-ocean model: Part 1 model overview and assessment of the hydrodynamics. *Journal of Marine Systems* 57:167-188.
- Huesemann M. H., Skillman A. D. & Creclius E. A., 2002. The inhibition of marine nitrification by ocean disposal of carbon dioxide. *Marine Pollution Bulletin* 44:142-148.
- Hutchins D. A., Fu F.-X., Zhang Y., Warner M. E., Feng Y., Portune K., Bernhardt P. W. & Mulholland M. R., 2007. CO<sub>2</sub> control of *Trichodesmium* N<sub>2</sub> fixation, photosynthesis, growth rates, and elemental ratios: Implications for past, present, and future ocean biogeochemistry. *Limnology and Oceanography* 52:1293-1304.
- Langdon C. & Atkinson M. J., 2005. Effect of elevated pCO<sub>2</sub> on photosynthesis and calcification of corals and interactions with seasonal change in temperature/irradiance and nutrient enrichment. *Journal of Geophysical Research - Oceans* 110, C09S07. doi:10.1029/2004JC002576.

- Levitan O., Rosenberg G., Setlik I., Setlikova E., Grigel J., Klepetar J., Prasil O. & Berman-Frank I., 2007. Elevated CO<sub>2</sub> enhances nitrogen fixation and growth in the marine cyanobacterium *Trichodesmium*. *Global Change Biology* 13:531-538.
- Lewis K., Allen J. I., Richardson A. J. & Holte J. T., 2006. Error quantification of a high resolution coupled hydrodynamic-ecosystem coastal-ocean model: Part 3, validation with Continuous Plankton Recorder data. *Journal of Marine Systems* 63:209-224.
- Moore J. K., Doney S. C., Kleypas J. A., Glover D. M. & Fung I. Y., 2002. An intermediate complexity marine ecosystem model for the global domain. *Deep Sea Research Part II* 49:403-462.
- Norberg J., Swaney D. P., Dushoff J., Lin J., Casagrandi R. & Levin S. A., 2001. Phenotypic diversity and ecosystem functioning in changing environments: A theoretical framework. *Proceedings of the National Academy of Sciences U.S.A.* 98:11376-11381.
- Orr J. C., Fabry V. J., Aumont O., Bopp L., Doney S. C., Feely R. A., Gnanadesikan A., Gruber N., Ishida A., Joos F., Key R. M., Lindsay K., Maier-Reimer E., Matear R., Monfray P., Mouchet A., Najjar R. G., Plattner G. K., Rodgers K. B., Sabine C. L., Sarmiento J. L., Schlitzer R., Slater R. D., Totterdell I. J., Weirig M. F., Yamanaka Y. & Yool A., 2005. Anthropogenic ocean acidification over the twenty-first century and its impact on calcifying organisms. *Nature* 437:681-686.
- Oschlies A., Schulz K. G., Riebesell U. & Schmittner A., 2008. Simulated 21st century's increase in oceanic suboxia by CO<sub>2</sub>-enhanced biotic carbon export. *Global Biogeochemical Cycles* 22, GB4008. doi:10.1029/2007GB003147.
- Pörtner H.-O. & Farrell A. P., 2008. ECOLOGY: Physiology and climate change. *Science* 322:690-692.
- Pörtner H.-O. & Knust R., 2007. Climate change affects marine fishes through the oxygen limitation of thermal tolerance. *Science* 315:95-97.
- Pörtner H.-O., Langenbuch M. & Michaelidis B., 2005. Synergistic effects of temperature extremes, hypoxia, and increases in CO<sub>2</sub> on marine animals: from Earth history to global change. *Journal of Geophysical Research- Oceans* 110, C09S10. doi:10.1029/2004JC002561.
- Raymond P. A. & Cole J. J., 2003. Increase in the export of alkalinity from North America's largest river. *Science* 301:88-91.
- Reynaud S., Leclercq N., Romaine-Lioud S., Ferrier-Pagès C., Jaubert J. & Gattuso J.-P., 2003. Interacting effects of CO<sub>2</sub> partial pressure and temperature on photosynthesis and calcification in a scleractinian coral. *Global Change Biology* 9:1660-1668.
- Ridgwell A., Zondervan I., Hargreaves J. C., Bijma J. & Lenton T. M., 2007. Assessing the potential long-term increase of fossil fuel CO<sub>2</sub> uptake due to CO<sub>2</sub>-calcification feedback. *Biogeosciences* 4:481-492.
- Riebesell U., Schulz K. G., Bellerby R. G. J., Botros M., Fritsche P., Meyerhöfer M., Neill C., Nondal G., Oschlies A., Wohlers J. & Zöllner E., 2007. Enhanced biological carbon consumption in a high CO<sub>2</sub> ocean. *Nature* 450:545-549.
- Rost B., Riebesell U., Burkhardt S. & Sultemeyer D., 2003. Carbon acquisition of bloom-forming marine phytoplankton. *Limnology and Oceanography* 48:55-67.
- Schmittner A., Oschlies A., Matthews H. D. & Galbraith E. D., 2008. Future changes in climate, ocean circulation, ecosystems, and biogeochemical cycling simulated for a business-as-usual CO<sub>2</sub> emission scenario until year 4000 AD. *Global Biogeochemical Cycles* 22, GB1013. doi:10.1029/2007GB002953.
- Stow C. A., Jolliff J., McGillicuddy D. J., Doney S. C., Allen J. I., Friedrichs M. A. M., Rose K. A. & Wallhead P., 2009. Skill assessment for coupled biological/physical models of marine systems. *Journal of Marine Systems* 76:4-15.
- Thomas H., Schiettecatte L. S., Suykens K., Koné Y. J. M., Shadwick E. H., Prowe A. E. F., Bozec Y., de Baar H. J. W. & Borges A. V., 2009. Enhanced ocean carbon storage from anaerobic alkalinity generation in coastal sediments. *Biogeosciences* 6:267-274.

- Tortell P. D., DiTullio G. R., Sigman D. M. & Morel F. M. M., 2002. CO<sub>2</sub> effects on taxonomic composition and nutrient utilization in an Equatorial Pacific phytoplankton assemblage. *Marine Ecology Progress Series* 236:37-43.
- Tortell P. D., Payne C. D., Li Y. Y., Trimborn S., Rost B., Smith W. O., Riesselman C., Dunbar R. B., Sedwick P. & DiTullio G. R., 2008. CO<sub>2</sub> sensitivity of Southern Ocean phytoplankton. *Geophysical Research Letters* 35, L04605. doi:10.1029/2007GL032583.
- Zeebe R. E. & Wolf-Gladrow D. A., 2001. *CO<sub>2</sub> in seawater: equilibrium, kinetics, isotopes*. 346 p. Amsterdam: Elsevier.

### 15 Safeguarding and sharing ocean acidification data

Stéphane Pesant<sup>1</sup>, Leslie Alan Hook<sup>2</sup>, Roy Lowry<sup>3</sup>, Gwenaëlle Moncoiffé<sup>3</sup>, Anne-Marin Nisumaa<sup>4,5</sup> and Benjamin Pfeil<sup>6</sup>

<sup>1</sup>Centre for Marine Environmental Sciences (MARUM), University of Bremen, Germany

<sup>2</sup>National Aeronautics and Space Administration, Distributed Active Archive Center (NASA DAAC), Oak Ridge National Laboratory, USA

<sup>3</sup>British Oceanographic Data Centre (BODC), UK

<sup>4</sup>Laboratoire d'Océanographie, CNRS, France

<sup>5</sup>Observatoire Océanologique, Université Pierre et Marie Curie-Paris 6, France

<sup>6</sup>Bjerknes Centre for Climate Research, University of Bergen, Norway

#### 15.1 Introduction

Despite the fact that most marine scientists agree with the principle that scientific data must be safeguarded and shared among the scientific community and must become public as soon as possible, there are several cultural and technological issues that minimise and often put off the application of that principle. For example:

- Many scientists do not realise that their data may be useful to other scientists; do not realise that other scientists' data may be useful to them; do not know where and how to archive their data; and do not know where and how to access other scientists' data.
- Organising and documenting data in order to meet the requirements of data archives requires time and efforts as with any other media for scientific communication (e.g. scientific papers, posters or oral presentations) but unlike these other media, archiving data is not perceived as bringing recognition of scientific work and is thus placed low on the list of priorities.
- The numerous sampling and analysis protocols used in ocean science are not described consistently in databases and are often not reported at all by scientists, which makes it difficult to harmonise masses of data and to have any confidence in the quality of meta-analyses performed on them, to the point where scientists lose interest in safeguarding and sharing data.
- Many scientists are anxious at the thought that anyone, and even colleagues, may extract data from databases and publish them without informing or acknowledging the authors. This is especially true for data that are not yet published in scientific journals or could still be reused as original contributions to science.

The objective of the present chapter is to address these issues and recommend solutions and best practices that lead to safeguarding and sharing data and metadata.

#### 15.2 Sharing ocean acidification data

This section addresses the following issues:

*“Many scientists do not realise that their data may be useful to other scientists.”*

*“Many scientists do not realise that other scientists' data may be useful to them.”*

*“Many scientists are anxious at the thought that anyone, and even colleagues, may extract data from databases and publish them without informing or acknowledging the authors.”*

Sharing data is a delicate issue because it deals with intellectual property rights, including the privilege to “be the first one to publish your own data”, within a scientific community where competition for funding enforces the saying “publish or perish”. The lack of confidence in the common respect of intellectual property rights is at the heart of the problem. When in doubt, most scientists will prefer to keep their data to themselves,

## Part 4: Data reporting and data usage

to share it with a few trusted ones, and to communicate data only in the form of posters, oral presentations and scientific publications. We must therefore find ways to raise trust within the scientific community and to prevent abuse of trust.

The purpose of data policies is to establish general guidelines and regulations regarding the fair exchange of data and effective collaboration between partners. We reviewed data policies of several data centres (e.g. SeaDataNet for National Data Centres, and three World Data Centres for oceanography and the marine environment) and those of major European and North American research projects relevant to ocean acidification, such as EPOCA, CARBOOCEAN, Ocean Carbon and Biogeochemistry Data Management Office (US-BCO-DMO) collections and EUR-OCEANS. We summarise here the common guidelines of these policies:

1. metadata (i.e. data about data; see section 15.6) are freely accessible without any condition;
2. data are freely accessible unless otherwise stipulated;
3. users must acknowledge/cite the original data providers;
4. all restrictions on the use and reproduction of data must be respected;
5. data must not be given to third parties without prior consent of data providers;
6. regardless of whether data are quality controlled or not, data archives and original data providers do not accept any liability for the correctness and/or appropriate interpretation of data;
7. any mistake in the data and metadata must be communicated to data archives.

The “principles and guidelines for access to research data from public funding”, published by the Organisation for Economic Co-operation and Development (OECD) is also a general reference of interest (<http://www.oecd.org/dataoecd/9/61/38500813.pdf>). It addresses the following principles: openness, flexibility, transparency, legal conformity, protection of intellectual property, formal responsibility, professionalism, interoperability, quality, security, efficiency, accountability and sustainability.

Research projects generally include restrictions in their data policy about *who* has access to data and for *how long*. Access to data is generally restricted to a specific research community, but the implementation of that restriction is problematic since passwords can be shared outside the community, individual e-mail requests to data providers rapidly becomes unmanageable, and files containing datasets can be passed around. Therefore, research communities that wish to effectively implement restrictions on data access usually channel all data requests through a single or a few individuals who guard the data. In EU projects within the Sixth Framework Programme, the main regulation imposed by the European Commission was that data generated by these projects must be disseminated within two years after the completion of the project. However, data policies sometimes propose shorter moratorium periods in order to stimulate the flow of data within a restricted community and outside of it, for example “*data must be accessible to the community within three months after the time of measurement*”, or “*data is restricted to the community for a period of two years after the time of measurement*”.

Some research projects have intellectual property right panels for protection, dissemination and exploitation of knowledge to ensure that data policies are observed. These panels become involved only if conflicts between partners arise, in which case they moderate and help resolve the conflict.

The Data Management Committee of the IGBP/SCOR project for Integrated Marine Biogeochemistry and Ecosystem Research (IMBER; [http://www.imber.info/DM\\_home.html](http://www.imber.info/DM_home.html)) acknowledges that “sticks” such as policies and conflict resolution panels are effective but also recommends promoting “carrots”, that call for technological developments as well as cultural changes. We highlight here some “carrots” to consider:

1. The anxiety related to misuse of data is partly due to a feeling of inequity between the many scientists who do not know how to extract data from databases and the few who are experts at it, for example modellers and bioinformaticians. A solution is to develop dissemination tools (e.g. data warehouses) that are easy to use by all scientists, i.e. not only by informatics literates, and therefore to reach a point where all scientists start using each other’s data.

2. Universally Unique IDentifiers (UUIDs including DOIs, URLs, URNs or LSIDs) are now widely used by scientific journals to cite their papers. Similarly, information systems such as the Publishing Network for Geoscientific and Environmental Data (PANGAEA®) are automatically registering every dataset with persistent Digital Object Identifiers (DOIs) that are used to cite data. Like most UUIDs, DOIs are used in web browsers to get online access to metadata and data (although sometimes restricted), which considerably helps identifying intellectual property. Several data centres are now tagging their datasets with UUIDs and recently, peer-reviewed and indexed journals such as Earth System Science Data (ESSD; <http://www.earth-system-science-data.net/>) allow researchers to rapidly publish data prior to their full analysis, thus obtaining public recognition of their property rights on the data.
3. Another means to reduce the anxiety related to misuse of data is to request from data archives and information systems that data users register before accessing data, offering the possibility to track who downloads what data. Researchers could then receive reports on usage of their data.

In conclusion, we recommend the ocean acidification community to insist upon database developers that “carrots” must be implemented, and to progressively relax restrictions on data usage in their data policies as a mean to “give trust a chance”.

### 15.3 Safeguarding ocean acidification data

This section addresses the following issue:

*“Many scientists do not know where and how to archive their data.”*

Safeguarding ocean acidification data is the business of permanent data archives, which, in the field of ocean science, comprise mainly the National Oceanographic Data Centres (NODCs) and the World Data Centres (WDCs). NODCs such as BODC in the UK, SISMER in France and US-NODC in the USA are designated by the International Oceanographic Data Exchange programme (IODE) of UNESCO Intergovernmental Oceanographic Commission (IOC), while World Data Centers such as WDC-MARE in Europe, WDC-Oceanography in the USA, Russia and China are designated by the International Council for Science (ICSU). The respective role of the NODCs and WDCs is ambiguous. The IODE model is that oceanographic laboratories archive their data in the NODC that has been designated for their country, so that data contents of one NODC is in principle distinct from that of the other NODCs. There is however no authority dictating the laboratories to follow the IODE model so that a wealth of data, especially in biology, are not submitted to NODCs. In contrast to this federated approach, the WDCs were set to fill a complementary role, which was to replicate data from all NODCs into centralised data archives, and thus to act as multiple backups around the globe. Over the years however, WDCs did not replicate each other but have instead specialised and now complement each other. WDCs often offer advanced services and data products because information systems are technically easier to develop using centralised databases. These services facilitate the integration and access to large data collections, and consequently, large collaborative research projects tend to submit data to WDCs. Furthermore, in many countries, NODCs do not yet have the capacity to archive and distribute genomics, molecular, taxonomic and ecological data or to handle data objects such as images or audio files. We recommend that in such countries, data be safeguarded in a WDC that has this capacity, with the understanding that a copy of the data will be delivered to the designated NODC once it has the capacity to archive such data. Lists of all current NODCs and WDCs can be found at <http://www.ngdc.noaa.gov/wdc/contact.shtml> and <http://www.iode.org>.

In conclusion, we wish to remind the reader that, while it is the business of NODCs and WDCs to archive ocean science data, it is the responsibility of the scientists (data providers) to properly document their data, to prepare them with a minimum of structure, and to submit them to data archives. The following sections discuss the importance of documenting data with care, and provide instructions on how to prepare data.

### 15.4 Harmonising ocean acidification data and metadata

This section addresses the following issue:

*“The numerous sampling and analysis protocols used in ocean science are not described properly in databases and are often not reported at all by scientists.”*

Metadata are data about data (see section 15.6). They describe *what* was measured *by whom*; *when*, *where* and *how* it was sampled and analysed; with *which instruments*, and following *which protocol*; and finally they describe the *units* and *currencies* in which measurements are expressed. The way metadata should be structured is defined by several standards. The most important ones in the geographic information domain are ISO 19115 (Kresse & Fadaie, 2004), Federal Geographic Data Committee (FGDC) (<http://www.fgdc.gov/metadata>), Directory Interchange Format (DIF) (<http://www.gcim.nasa.gov/User/difguide>), and Dublin Core Metadata Initiative (DCMI) (<http://dublincore.org/documents/dcmi-terms>). They provide the structure to document not only bibliographic information, such as authors, title, date, publisher, and keywords, but also spatial and temporal coverage, methods and data quality. These “contents” standards are the backbone of metadata; the challenge for the scientific and data management communities is to develop standard vocabularies to document the data in a consistent and accurate way.

Registers are authoritative bodies that build and maintain vocabulary databases, and offer web services to encourage the implementation of standard vocabularies. Taxonomic registers and chemical substances registers are particularly relevant to ocean acidification research. The main taxonomic registers are the World Register of Marine Species (WoRMS which grew from the European Register of Marine Species (ERMS); <http://www.marinespecies.org/>) and the International Taxonomy Information System (ITIS; <http://www.itis.gov/>). To our knowledge, the most authoritative collection of disclosed chemical substance information is the Chemical Abstracts Service (CAS; <http://www.cas.org/>) of the American Chemical Society. All these registers are updated by editorial boards of specialists and provide unique identifiers for the entities that they describe. We recommend using these registers as much as possible to describe data.

For other vocabularies pertaining for example to mesocosm experiments or carbonate chemistry computations (see section 15.6.2), we recommend the voluntary appointment of “standard vocabulary editors” from the ocean acidification scientific community to ensure a coherence between scientific requirements and data management practices (see section 15.7), building on existing initiatives such as those undertaken by the Intergovernmental Oceanographic Commission’s IODE programme (<http://www.iode.org/>), the NERC Data Grid programme (<http://ndg.nerc.ac.uk/>), the SeaDataNet programme (<http://www.seadatanet.org/>), and the Marine Metadata Interoperability network (<http://marinemetadata.org/>).

Defining standard vocabularies for analytical methods and defining standard units can prove most challenging. We are now faced with vast repositories of digital data where the same parameter is measured differently and is stored in a range of units. There is no standard vocabulary for analytical methods and these are often not reported at all by data providers, or even sometimes not requested by data centres. The present guide recommends ways to report analytical methods relevant to ocean acidification research (see section 15.6), but in the case of historical data archives, differences in analytical methods will need to be sorted out by going back to the original papers or contacting data providers. On a brighter note, differences in units may be due simply to scaling factors (e.g. per millilitre vs. per litre), the refusal of imperial measurements to die (e.g. knots vs. metres per second), or confusion among mass and amount concentrations (e.g. grams per litre vs. moles per litre and cells per litre). These differences can be sorted by simple conversions. However, the harmonisation of parameters reported per litre vs. per kilogram of seawater requires additional data (*in situ* seawater density or salinity, and temperature) that are often estimated in the absence of *in situ* measurements (see section 15.6.2 for examples with carbonate chemistry).

Centralised data centres such as BODC, SISMER, the Carbon Dioxide Information Analysis Centre (CDIAC) and World Data Centres have tried to address these problems by adopting “in house” standard vocabularies for methods and “in house” standard units using different conversion factors. However, it is not a viable option for distributed systems of data centres since different standard units have been used in different data centres.



There are two ways to deal with the units issue in a distributed scenario. One is to keep units as part of the parameter vocabulary and create the necessary additional entries in the parameter dictionary for the different units. The other approach is to maintain a totally separate metadata field for units, which can then be attributed to parameters. The former way was soon seen to be undesirable because it results in parameter dictionaries of such a size that they become unmanageable. Consequently, the approach now advocated by most data centres is that units should have their own standard vocabulary that is dissociated from the parameter vocabulary.

For the sake of archiving data in a standard way, data providers and data managers should follow the International System of Units (SI) as much as possible in their choice and scaling of units, for example using molinity (amount per mass of seawater) for molar concentrations instead of molarity (amount per volume of seawater), and scaling molinity in units of moles per kilograms instead of micromoles per kilograms. These choices may in some cases increase the number of digits (integers or decimals) and may get us away from “practical units” that are usually reported in scientific communications or from “output units” given by instruments. In cases where metadata about the methods are missing, the original units may be the only way to differentiate among methods that are not comparable and should therefore not be combined, for example primary production measured in a few millilitres sample incubated under constant irradiance over 1 hour vs. primary production measured in 1 litre sample incubated under natural light conditions over 24 hours. This is the main argument in favour of “sticking” to the original units, as a means to stress methodological differences. We recommend that data providers submit data with their original units, and provide detailed methods (i.e. sample treatment and analysis) and conversion factors to SI units (e.g. molarity to molinity) as part of metadata (see section 15.6 on how to report data and metadata). We also recommend that data be converted and archived in SI units by data managers, keeping record in the metadata of the original units used by the data provider. Major data centres should eventually be able to automatically “read out” units in their archives so that major information systems can provide users with harmonised data outputs in which units have been converted according to the user’s preferences.

In section 15.3, we discussed the use of UUIDs to facilitate the citation of datasets and improve the preservation of intellectual property rights. Here we wish to recommend that UUIDs be also assigned upstream of the data archiving process, i.e. to the samples themselves (e.g. unique sample identifiers), ensuring that all data generated from a given sample can be tracked, interconnected, re-assembled and harmonised during meta-analysis. The use of open-source and commercial “sample-tracking platforms” is now common in medical, molecular and genetics research and should be envisaged as well by the ocean science community, particularly in the case of multidisciplinary projects conducted in the field and in experimental facilities where one sample leads to several analyses including metagenomics, molecular and elemental composition, taxonomy, metabolic activities and trophic interactions. Groups of experts such as the Biodiversity Information Standards, previously known as the Taxonomic Database Working Group (TDWG; <http://www.tdwg.org/>) are investigating the use of UUIDs to track samples in ocean science. We recommend that research projects be proactive by initiating their own “sample tracking system” and keeping an eye out for any standard practices that are being developed.

## 15.5 Disseminating ocean acidification data and metadata

This section addresses the following issue:

*“Many scientists do not know where and how to access other people’s data.”*

Metadata are data about data (see section 15.6). Disseminating data and metadata is the business of information systems such as Google™ and various wikis. In the geoscientific world, information systems are also known as “data portals”, “data directories” or “clearinghouses”. The purpose of information systems is to search for and harvest data from various archives and repositories, to repackage them into predefined or customisable collections of data/products, and to disseminate these products to the public or sometimes to a restricted group of users, as discussed in section 15.2. Information systems differ in the type of archive that they use and in the service they provide. It may consist of static collections of files containing data and metadata (e.g. FTP style portals), of a relational meta-database supporting a dynamic search of predefined datasets (e.g. Google-like

portals), or of a relational database that enables mass extraction and re-packaging of data from a large number of datasets, using advanced search functions (e.g. data warehouses).

The first product (e.g. FTP style portals) is typical of large research projects that generate finite collections of files containing datasets that need to be shared among collaborators who already know about the data. However, these datasets include a lot more than what general users are looking for, and most importantly, data and metadata are often organised and formatted in very different ways from file to file.

The second product (e.g. Google-like portals) allows users to target more specifically the type of data they are looking for, but the “granularity” of data in a relational database can be very fine (e.g. each CTD cast can constitute a dataset) so that users end up with a huge number of datasets to download. Although the organisation and formatting of these datasets may be more homogeneous, assembling them proves to be a challenge that is often difficult to manage.

The third product (e.g. data warehouses) allows users to select parameters (variables) that are of interest and to extract only the corresponding values out of the entire database, and to re-package them in a table format. These products must be used with care to ensure that users do not lose essential metadata information in the process. For instance, in the resulting data table, each value should always be accompanied by geographical and temporal references (latitude, longitude, date, time, depth), parameter names and units, some details on the methodology used for sampling and/or analysis, and a citation.

There are a few information systems related to ocean acidification knowledge; they include OCB-DMO (<http://ocb.whoi.edu/>), CDIAC (<http://cdiac.ornl.gov/>) and PANGAEA® (<http://www.pangaea.de/>). The first two systems offer a dynamic search of metadata that leads to an “FTP style portal”, while the latter information system offers a “Google-like portal” and a “data warehouse” (beta version).

It is the responsibility of the ocean acidification community to request from NODCs and WDCs that ocean acidification data and metadata be made available to the relevant information systems, notably the three mentioned above. To ensure a wider dissemination of ocean acidification knowledge, data and metadata should also be distributed to other communities via their own relevant information systems, for example the Ocean Biogeographic Information System (OBIS; <http://www.iobis.org/>) for the biodiversity and Census of Marine Life community, (COPEPOD; <http://www.st.nmfs.noaa.gov/plankton/>) for the International Council for the Exploration of the Sea (ICES), the Mediterranean Science Commission (CIESM) and the plankton research community, and the European Molecular Biology Laboratory – European Bioinformatics Institute (EMBL-EBI; <http://www.ebi.ac.uk/>) for the molecular and genomics community. In turn, these information systems could become a useful source of complementary data to the ocean acidification community.

### 15.6 Reporting data and metadata

This section addresses the following issue:

*“Organising and documenting data in order to meet the requirements of data archives requires time and efforts, as with any other media used by scientists to communicate their findings, e.g. scientific papers, posters or oral presentations.”*

The previous sections of this chapter outlined important issues that must be regularly discussed by the ocean acidification scientific community to ensure that ocean acidification knowledge is shared, safeguarded, harmonised and disseminated. The first step to address these issues is to adequately prepare ocean acidification data by providing the relevant metadata, describing *who* measured, observed or calculated *what*, *where*, *when* and *how*. Metadata about “*where*” and “*when*” are generally well documented, while metadata regarding the other questions are very often overlooked. Metadata about “*who*” measured, observed or calculated data are essential to ensure intellectual property rights. Metadata about “*what*” was measured and “*how*” are essential to harmonise data and gain confidence in the quality of meta-analyses performed on them. Preparing metadata does require time and efforts, but we must educate researchers to these practices and raise the value of “archiving data” to the level of other types of scientific communications, such as scientific papers, posters or

oral presentations. The Data Management Committee of the IGBP/SCOR project IMBER ([http://www.imber.info/DM\\_home.html](http://www.imber.info/DM_home.html)) recommends a few actions to reach that goal.

First, research programmes must allocate funding to data management. Each programme should hire a person to create metadata, contact scientists to prepare and submit their data, aggregate datasets that are related but come from different sources, and submit/import data into a database. This person could be a recent graduate who would get trained by a data centre. Recent research programmes on ocean acidification, such as the European projects CARBOOCEAN and EPOCA, have implemented this recommendation and are indeed contributing masses of ocean acidification knowledge to data centres and information systems such as CDIAC and WDC-MARE/PANGAEA®.

Second, the scientific community, including field and laboratory scientists, modellers and data managers, must define together best practices as well as clear instructions and templates for the preparation and submission of data and metadata. There are a few recent guides of “best practices” for preparing environmental data (Hook *et al.*, 2007) and CO<sub>2</sub> measurements (Dickson *et al.*, 2007). We reviewed the best practices reported in these guides and those put forward by ocean acidification-related research programmes (e.g. CARBOOCEAN, EPOCA, EUR-OCEANS and MARBEF) and ocean acidification-related data centres and initiatives (e.g. CDIAC, WDC-MARE/PANGAEA®, OCB-DMO, IODE’s network of NODCs and SeaDataNet). We recommend four general best practices to report data and metadata:

1. ***be informative when you assign names, titles and descriptions***, for example with data files, parameters, sampling and analysis methods, units and formats;
2. ***be consistent in the way you assign that information and refer to well-recognised vocabulary registers when applicable***, for example with taxonomy, equipment and sensors, standard parameter names and standard units (see section 15.4);
3. ***be consistent in the way you format values***, for example decimal degrees vs. degree minutes seconds, YYYY-MM-DD (ISO 8601, recommended format) vs. DD-MM-YYY vs. MM/DD/YYYY, local date and time vs. GMT, decimal and digit group separators; and
4. ***be conscientious in performing basic quality assurance***, for example lookout for outliers, duplicates, mistakes in latitude or longitude, and properly distinguish between “missing values” and true “zero values”.

Beyond these general recommendations, research programmes and data centres related to ocean acidification also provide instructions and templates to guide the preparation of data and metadata. We have reviewed the most common ones and provide here a description of the core metadata and data requirements (section 15.6.1), followed by a synthesis of the specific metadata and data requirements that were identified in chapters 1 to 15 of the present guide (section 15.6.2).

### 15.6.1 Core metadata requirements

It is recommended that metadata always include the following information:

- ***Dataset citation***: title, summary, date created and last updated, authors contact details (last name, first name, e-mail, institution name, address and description), reference to related publications (authors, year, title, source, volume, pages, UUID), and reference to related research project (name and UUID).
- ***Sampling events***: event name (code), fieldwork/experiment name, research infrastructure name (e.g. ship, mesocosm, laboratory), responsible scientist name (include contact details if different from authors given in the citation), sampling device name, sampling device method, sampling quality, sampling comment, sampling reference (text or UUID), latitude (start, end and/or nominal), longitude (start, end and/or nominal), date (start, end and/or nominal), time (start, end and/or nominal).
- ***First order parameters***: parameter name, parameter short name (often used in data tables where values are reported), parameter type (e.g. computed/calculated individual value, measured/determined

individual value, sum of individual values, statistical value obtained from individual values), units, responsible scientist name (include contact details if different from authors given in the citation), access rights (public or restricted), analysis device name, analysis device method, analysis quality (e.g. flags, detection limits and uncertainty), analysis comment, and analysis reference (text or UUID).

Second order parameters are used to subdivide the first order parameters that are for example taxon-specific, gender-specific, pigment-specific or size-fractionated. When appropriate, the following information should be provided:

- **Second order parameters about taxonomy:** a list of taxonomic name used in the dataset, if possible a taxonomic reference for each taxon (name of the taxonomy register, registered taxon-ID, registered taxon name, and UUID), and reference material (ID, location, condition, last check). See section 15.4 for details on taxonomy registers.
- **Second order parameters about life cycles (e.g. gender, age, development stage):** name, description, reference (text or UUID).
- **Second order parameters about chemical composition (from atoms to large molecules):** name, description and, if possible, a chemical composition reference (name of the chemistry register, chemical component ID and UUID). See section 15.4 for details on chemistry registers.
- **Second order parameters about metrics (e.g. size classes and wavelengths):** metrics name, description, units, lower limit, and upper limit.
- **Second order parameters about digital objects (e.g. maps, figures, pictures, audio or video files):** name, description (including format, method used to generate the object, and recommended method to read/use the object).

There are several forms and templates being proposed by the different data centres and data management groups to help prepare and organise metadata and data. In many cases, data providers are asked to fill in text forms with the relevant metadata and to submit it separately from the files containing the data. Sometimes, the files containing the data are submitted long after the metadata forms are submitted, risking that datasets become updated and no longer correspond to the information provided in the metadata form. Sometimes, files containing datasets are simply not submitted, kept locally, and made available upon request. Generally, we recommend that data and metadata be prepared and submitted together and, as much as possible, in the same file.

### 15.6.2 Specific metadata requirements

Here we summarise and complement the recommendations of parts 1 to 4 of this guide concerning data reporting for seawater carbonate chemistry, perturbation experiments, CO<sub>2</sub> sensitive processes and model outputs.

#### **Seawater carbonate chemistry and ancillary parameters (Part 1)**

It is essential to provide measurements of temperature and salinity when reporting data for seawater carbonate chemistry. Moreover, we strongly recommend that the following metadata information is included:

- **Dissolved inorganic carbon (DIC) concentration (mol kg<sup>-1</sup>):** information about sample replication, sample volume, poisoning (poison volumes), analysis method (technique description, reference), CRM information (correction magnitude, batch number, analysis log), overall precision, and accuracy.
- **Total alkalinity (A<sub>T</sub>) (mol kg<sup>-1</sup>):** curve fitting method, type of titration (reference), description of other titration, cell type, CRM scale, sample volume, magnitude of blank correction, overall precision and accuracy.
- **Carbon dioxide partial pressure (p(CO<sub>2</sub>); atmosphere):** information about sample replication, storage method, analytical method (technique description, reference), sample volume, headspace volume, *in situ* temperature, temperature during measurement, temperature normalisation, temperature correction method, variable reported, gas, standard gas concentrations, frequency of standardisation, overall precision and accuracy.

- **pH:** pH scale, analytical method (technique description including, when appropriate, probes, buffer names and reference), *in situ* temperature, temperature during measurement, temperature normalisation, temperature correction method, *in situ* pressure, calibration method, overall precision and accuracy.

The R package seacarb (Lavigne & Gattuso, 2010) is often used to compute a complete and consistent set of carbonate chemistry parameters, using original values of temperature and salinity, and any pair of the carbonate chemistry parameters listed above (see chapter 2). Also, if available, the concentrations of silicate and phosphate can be used in seacarb as additional ions contributing to the carbonate chemistry and thus allowing for more robust computations. When original values are expressed in mol l<sup>-1</sup>, we recommend converting them first to mol kg<sup>-1</sup> by using seawater density that is calculated from salinity and temperature as indicated in Dickson *et al.* (2007). Seacarb can only use pH measured on the total scale as an input term. When pH is reported on a scale other than the total scale, we recommend to first calculate DIC and A<sub>T</sub> with CO2SYS (Lewis & Wallace, 1998) using pH (other scale) and another carbonate chemistry parameter, and subsequently use these DIC and total alkalinity values in seacarb to estimate pH on the total scale, as well as nine other carbonate chemistry parameters. Seacarb uses flags to specify which pair of seawater carbonate chemistry parameters are used for computations. We extend this list of Carbonate Chemistry Computation flags (CCC flags) to include cases where pH is not available on the total scale (Table 15.1). When archiving computations from seacarb (Lavigne & Gattuso, 2010) and/or CO2SYS (Lewis & Wallace, 1998), we strongly recommend that the method of calculation and the appropriate flag be written out fully in the metadata. For example with pH, “pH was computed on the total scale using seacarb (Lavigne & Gattuso, 2010) from DIC and total alkalinity. DIC was first calculated with CO2SYS (Lewis & Wallace, 1998) using pH (other scale) and total alkalinity as input parameters (CCC flag 29)”. It is essential that a table explaining the CCC flags is provided to the data centres.

The primary goal of data reporting for climate targets is to provide a template for comparing experimental results among the atmospheric, ocean and terrestrial science communities. Towards that goal, ocean acidification studies should carefully report the p(CO<sub>2</sub>) levels (in µatm) of interest for the study, with the various parameters of the ocean carbonate chemistry (see above). The use of common currency of atmospheric carbon dioxide levels and the use of standard or key p(CO<sub>2</sub>) values for most studies will elevate the value of ocean acidification science for society.

### ***Perturbation experiments (Part 2)***

It is relatively easy to distinguish between parameters that are determined in the field (e.g. measured *in situ* or determined directly or experimentally from samples collected at sea) and those determined on samples that are not specific to any geographic location (e.g. in laboratory experiments). However, the distinction between field experiments under “natural conditions” (*in situ* or simulated) and those under “artificial conditions” can be unclear. With respect to data reporting, we propose the following distinction:

- ***Perturbation experiments under natural conditions:*** they include short-term field experiments under *in situ* conditions (e.g. *in situ* incubations for primary production), simulated natural conditions (e.g. deck incubations for primary production), modified environmental conditions within natural range (e.g. photosynthetic, chemostats and nutrient uptake), or modified assemblages within natural range (e.g. dilution method to measure grazing rate).
- ***Perturbation experiments under artificial conditions:*** they include long-term experiments (>1 day) in mesoscale enclosed systems (mesocosms) with natural or modified assemblages under modified environmental conditions, and long-term enrichment experiments (>1 day) in the field, for example iron enrichment experiments.

Perturbation experiments under artificial conditions allow for biological interactions and are considered to replicate natural conditions more accurately than laboratory experiments, but on the long term these systems drift from the initial conditions and measurements should no longer be considered as “natural” observations.

**Table 15.1.** List of Carbonate Chemistry Computation (CCC) flags describing which pair of carbonate chemistry parameters is used for computations in seacarb and CO2SYS in addition to temperature and salinity.

CCC flag	Computation software	Input parameters (in addition to temperature and salinity)
1	seacarb	pH (total scale) and CO <sub>2</sub>
2	seacarb	CO <sub>2</sub> and HCO <sub>3</sub> <sup>-</sup>
3	seacarb	CO <sub>2</sub> and CO <sub>3</sub> <sup>2-</sup>
4	seacarb	CO <sub>2</sub> and A <sub>T</sub>
5	seacarb	CO <sub>2</sub> and DIC
6	seacarb	pH (total scale) and HCO <sub>3</sub> <sup>-</sup>
7	seacarb	pH (total scale) and CO <sub>3</sub> <sup>2-</sup>
8	seacarb	pH (total scale) and A <sub>T</sub>
9	seacarb	pH (total scale) and DIC
10	seacarb	HCO <sub>3</sub> <sup>-</sup> and CO <sub>3</sub> <sup>2-</sup>
11	seacarb	HCO <sub>3</sub> <sup>-</sup> and A <sub>T</sub>
12	seacarb	HCO <sub>3</sub> <sup>-</sup> and DIC
13	seacarb	CO <sub>3</sub> <sup>2-</sup> and A <sub>T</sub>
14	seacarb	CO <sub>3</sub> <sup>2-</sup> and DIC
15	seacarb	A <sub>T</sub> and DIC
21	seacarb	p(CO <sub>2</sub> ) and pH (total scale)
22	seacarb	p(CO <sub>2</sub> ) and HCO <sub>3</sub> <sup>-</sup>
23	seacarb	p(CO <sub>2</sub> ) and CO <sub>3</sub> <sup>2-</sup>
24	seacarb	p(CO <sub>2</sub> ) and A <sub>T</sub>
25	seacarb	p(CO <sub>2</sub> ) and DIC
26	<i>Step 1.</i> CO2SYS	pH (other scale) and p(CO <sub>2</sub> )
	<i>Step 2.</i> seacarb	A <sub>T</sub> and DIC (from CO2SYS)
27	<i>Step 1.</i> CO2SYS	pH (other scale) and HCO <sub>3</sub> <sup>-</sup>
	<i>Step 2.</i> seacarb	A <sub>T</sub> and DIC (from CO2SYS)
28	<i>Step 1.</i> CO2SYS	pH (other scale) and CO <sub>3</sub> <sup>2-</sup>
	<i>Step 2.</i> seacarb	A <sub>T</sub> and DIC (from CO2SYS)
29	<i>Step 1.</i> CO2SYS	pH (other scale) and A <sub>T</sub>
	<i>Step 2.</i> seacarb	A <sub>T</sub> and DIC (from CO2SYS)
30	<i>Step 1.</i> CO2SYS	pH (other scale) and DIC
	<i>Step 2.</i> seacarb	A <sub>T</sub> and DIC (from CO2SYS)
31	<i>Step 1.</i> CO2SYS	pH (other scale) and p(CO <sub>2</sub> )
	<i>Step 2.</i> seacarb	A <sub>T</sub> and DIC (from CO2SYS)

Apart from their time-zero measurements, data collected from an artificial environment created in the laboratory or in mesocosms must not be confounded with data measured *in situ* or from field experiments under natural conditions. Given that some metadata fields are sometimes not requested by users during mass extraction of data from databases, especially metadata fields such as “comments”, “notes” or even “methods description”, it is not sufficient to simply mention in these fields that data are from an artificial environment. We strongly recommend that data collected from an artificial environment be archived without any geographic coordinates (latitude or longitude). Sampling date, time and depth (e.g. in mesocosms or large scale enrichment experiments) can be archived as usual, but the geographic coordinates of the artificial/perturbed environment should be archived as an attribute of the sampling infrastructure/platform, not as an attribute of the data itself.

When reporting data for perturbation experiments, it is strongly recommended to include the following metadata information:

1. **Initial state and quality:** where and when samples or specimens were collected; in the case of plankton, describe the initial environmental and community conditions; in the case of specimens, describe the body size and other biometrics, information on their life cycle such as gender, reproductive state, age and developmental stage.
2. **Relevance of experimental treatments to natural field conditions:** the environmental conditions where samples/specimens were collected; and the natural values of experimental end points in field community/population.
3. **Experimental environmental conditions:** the temperature and salinity in each treatment; measurement of at least two carbonate chemistry parameters (see Table 15.1) from each treatment; accurate description of the methods used to measure carbonate parameters including pH scales and buffers where appropriate; values at the beginning and end of the experiment, and if available, values during the experiment should be provided.
4. **Experimental treatment (carbonate chemistry – chapter 2 and 6):** time course of CO<sub>2</sub> manipulation; control of carbonate chemistry during the experiment; control of p(CO<sub>2</sub>) in closed headspace vs. open headspace with ambient p(CO<sub>2</sub>); method of CO<sub>2</sub> manipulation; in the case of aeration with air at target p(CO<sub>2</sub>), indicate p(CO<sub>2</sub>) level and flow rate; in the case of addition of high-CO<sub>2</sub> seawater, indicate p(CO<sub>2</sub>) and mixing ratio; in the case of addition of strong acid as well as CO<sub>3</sub><sup>2-</sup> and/or HCO<sub>3</sub><sup>-</sup>, indicate volume and normality of acid added as well as the quantity of inorganic carbon added; in the case of addition of strong acids and bases, indicate volume and normality; in the case of manipulation of the Ca<sup>2+</sup> concentration, indicate the recipe of artificial seawater used.
5. **Experimental treatment (batch culture – chapter 5):** basic information characterising the physiological state of the initial inoculum including cell density of the stock culture, number of cells inoculated, chlorophyll per cell, growth, irradiance, temperature, and composition of the initial culture media.  $F_v/F_m$  would give information on whether the stock culture was nutrient replete and growing in exponential phase, nutrient limited, or in stationary phase; the investigators should also report whether or not the cultures were axenic and indicate in the metadata if frozen culture is available for future examination.
6. **Experimental treatment (mesocosms – chapter 6):** mesocosm dimensions and duration of the experiment; experimental design, layout of treatments and replication; enclosure filling methods; initial conditions; mixing configuration and turbulence characteristics and, wherever possible, direct velocity measurements of turbulent mixing should be conducted and reported; sampling methods; unintended perturbations such as shifts in plankton community composition, aggregation of dissolved or particulate matter and wall growth.
7. **Experimental treatments (specimens – chapter 7):** nature and magnitude of incremental changes in specimens' acclimation; the length of time between steps or total acclimation period or whether they were immediately exposed to the full treatment levels; indication or measure of specimens' stress;

length of time that specimens were exposed to the treatment; and comparison with “control” field specimens if possible.

8. **Experimental treatments (natural gradients and *in situ* perturbations – chapter 8):** for *in situ* perturbation, describe the experimental design, layout of treatments and replication; for natural gradients in pH or other carbonate system parameters, describe potential limitations of the design (e.g. lack of interspersed or replication, temporal and spatial variability, etc.); whenever possible, potentially confounding factors (e.g. methane, sulphide, temperature, oxygen) should also be monitored and reported.

### ***CO<sub>2</sub>-sensitive processes (Part 3)***

#### ***Metabolism, pH enantiostasis (chapter 9):***

- Describe the experimental procedure: exposure regime, length of exposure, water physicochemistry values (levels of e.g. pH, bicarbonate, carbonate, calcium) on physiologically relevant scales.
- Describe the sampling methods: animal acclimation and treatment, sampling procedure for tissues, dye, wavelengths of excitation and emission, time resolution, local resolution (whole tissue layer, whole cell, cellular compartment).
- Describe the analyses: tissue and cell type, investigated parameters, experimental tools (buffer systems, calibration procedures, ion gradients) and pharmacological tools (specific transport inhibitors, inhibitors of carbonic anhydrase).
- Report ancillary data: fluorescence intensities vs. wavelength (in a region of interest), variability between replicates.
- Describe metabolism and pH enantiostasis data: ratios that are linearly correlated to pH in a given range, pH, H<sup>+</sup> flux values (nM H<sup>+</sup> time<sup>-1</sup> (membrane area)<sup>-1</sup>).
- Report time constants for pH recovery due to systemic or cellular mechanisms and relative (%) change in ratio in paired experiments.
- Report rate of pH change under pH disturbance or recovery and acid-base variables during quantitative treatments of acid-base status.

#### ***Organic and export production, elemental ratios (chapter 11):***

Data normalisation is often required for the assessment of how acidification affects biogeochemical, physiological and ecological processes. Normalisation can be defined as a mathematical process that adjusts for differences among data from varying sources in order to create a common basis for comparison. For example, determining the amount of CaCO<sub>3</sub> (“calcmass”) or its rate of production generally involves measuring the dissolved and particulate concentrations of an element and its uptake by organisms or communities, and normalising these quantities using the proportion of calcifiers in the community and the ratio of CaCO<sub>3</sub> to the selected element in calcifiers’ biomass. In that case, it is recommended to archive values for the measured variables, values of the computed yield or production rate of CaCO<sub>3</sub>, and values of the normalisation factors used in the computation.

#### ***Pelagic calcification (chapter 12):***

- In studies that directly measure calcification rates in planktonic calcifiers, provide clear descriptions of the experimental design and protocols.
- Precision and accuracy in measurements of the parameters of the CO<sub>2</sub> system and associated factors (e.g., temperature, salinity, nutrient concentrations) should be reported.
- Report other experimental conditions that may affect calcification rates in photosynthetic or heterotrophic organisms, for example, irradiance, light/dark cycles, nutrient and trace element concentrations, food availability, feeding frequency, and grazing.
- Describe the method of collection of organisms and provide the size range (and age, if known) of the organisms used in the experiments.



- For manipulative experiments at different  $p(\text{CO}_2)$  levels, describe any acclimation period and the conditions experienced by the organisms during that time.
- In isotope tracer measurements of calcification rates, the blank values and their variability over the duration of the experiment should be reported. Equations for the calculation of calcification based on isotope measurements should be described, and all relevant information included, such as whether the bicarbonate concentration is assumed constant regardless of water mass or whether an isotope discrimination factor is assumed.
- In any case, if calcification rates are normalised (e.g. to chlorophyll or shell mass), it is recommended to archive values for the measured variables, normalised values, and values of the normalisation factors used in the computation.

### ***Benthic calcification (chapter 13):***

- Describe the mode of chemical manipulation: acid only, bicarbonate followed by acid or bubbling, etc.
- Report the strength of the acid, carbonate chemistry of the treatment water (ideally  $A_T$  and DIC), scale and calibration of pH electrode, temperature at which the pH is measured, when bubbling with air, report the source of the air (i.e. outside air vs. room air).
- Report the method used for measuring calcification, temperature and salinity, irradiance in quantum units, dissolved nutrient levels, organism's feeding state.
- Rates of calcification should be reported per area of living tissue ( $\text{cm}^2$  or  $\text{m}^2$ ), per weight of protein or per mass of skeleton.
- In the case of field based measurements of calcification, report water depth, current speed and percent cover of calcifiers as well as a description of community structure and the usual physical measurements of temperature, salinity, nutrients, light and water clarity.

## **15.7 Avoiding pitfalls and addressing challenges**

The previous sections have identified a few serious pitfalls that raise a number of challenges, notably addressing intellectual property rights and raising trust among the scientific community, and harmonising data and metadata by adopting standard vocabularies and unit conversion procedures.

To address these challenges, an emerging trend in scientific data infrastructures is to create expert groups, comprising field and laboratory scientists, modellers and data managers, for different categories of data. These categories can be defined based on the type of equipment used or analysis performed or, more generally, on research fields. Different expert groups may for example address “zooplankton net sampling”, “flow cytometry” or “primary production and plankton community metabolism”. The goals of these expert groups are to:

1. Promote and facilitate the submission of data into designated National Oceanographic Data Centres and/or World Data Centres. Each expert group needs to identify the information system that is most relevant to disseminate its respective data to their scientific community, including modellers (see section 15.5) and must request from NODCs and WDCs that data be made available to the information system of their choice.
2. Develop standard vocabularies describing variables, sampling protocols and analytical methods. This work should be lead by data managers from the relevant information systems and data centres, building on existing initiatives (see section 15.4). The expert groups are expected to constitute or to take part in a network of “standard vocabulary editors” that review existing vocabularies and later approve changes and additions.
3. Recommend best practices to harmonise existing data and plan the collection of new data. Harmonisation involves the cross-validation of traditional and emerging methodologies (sampling and analysis), the organisation of expert-to-expert validation, and the review of conversion factors and algorithms. Planning involves selecting and promoting preferred sampling and analytical protocols for future studies.

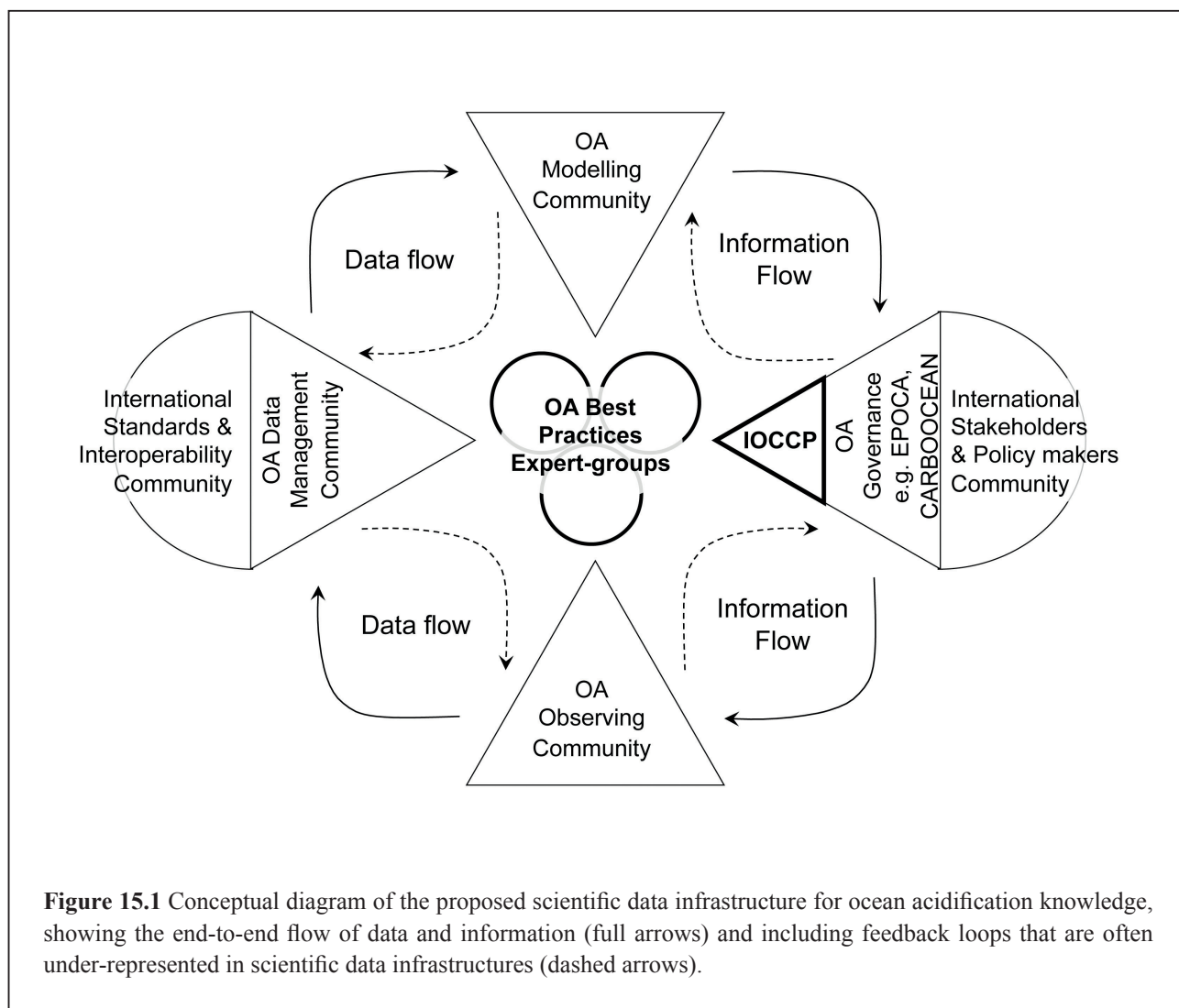

IODE’s Group of Experts on Biological and Chemical Data Management and Exchange Practices (GE-BICH) has initiated work in that respect on sampling instrumentation used in biological and chemical oceanography (see report in references). In the field of ocean acidification, we recommend to create three expert groups based on the structure of the present guide (seawater carbonate chemistry, perturbation experiments, and CO<sub>2</sub>-sensitive processes). The authors of these chapters are potential candidates. Figure 15.1 illustrates how a scientific data infrastructure for ocean acidification could work in line with recommendations from the Global Earth Observation System of Systems (GEOSS; <http://www.epa.gov/geoss/>). The proposed scientific data infrastructure for ocean acidification basically brings together four communities with distinct roles: the observing community (field and laboratory scientists), data management community, modelling community and governance community. Representatives from all four communities work together as part of ocean acidification “OA” Best Practices Expert Groups and could be coordinated by the IOCCP and the IOC/ IODE, with the overall goal to facilitate the end-to-end flow of ocean acidification data and information in the scientific community, and to stakeholders and policymakers. The proposed infrastructure imposes that data be archived and harmonised via the data management community, following the recommendations of the expert groups. In the proposed infrastructure, arrows show the flow of data and information, not the interactions among the different communities. Interactions among observing, modelling and data management communities occur in the expert groups and of course in research projects outside the infrastructure, but this is not illustrated here.

## 15.8 Recommendations for standards and guidelines

1. **Sharing knowledge.** In addition to using “sticks” such as data policies and conflict resolution panels, “carrots” should be used to promote sharing ocean acidification knowledge. These “carrots” call for both technological developments by the data management community and cultural changes in the scientific community. Technological developments include the use of Universally Unique Identifiers to reference data, and the development of tools to access masses of data and to track usage of data (section 15.2).
2. **Safeguarding knowledge.** Ocean acidification data and metadata should be safeguarded in National and/or World Data Centres that have the capacity to archive and distribute as needed genomics, molecular, taxonomic and ecological data, and data objects such as images and audio files (section 15.3).
3. **Harmonising data and metadata.**
  - A “standard vocabulary editor” from the ocean acidification scientific community should take part in existing initiatives such as those undertaken by the Intergovernmental Oceanographic Commission’s IODE programme (<http://www.iode.org/>), the NERC Data Grid programme (<http://ndg.nerc.ac.uk/>), the SeaDataNet programme (<http://www.seadatanet.org/>), and the Marine Metadata Interoperability network (<http://marinemetadata.org/>). The objective is to develop and maintain standard vocabularies and ontologies describing *what* is measured and *how* (section 15.4).
  - Research programmes should use unique sample identifiers and use “home-made” sample tracking systems, until standard ones are available. The objective is to ensure that all data generated from a given sample are tracked, interconnected, re-assembled and harmonised during meta-analysis (section 15.4).
4. **Disseminating data and metadata.** National and World Data Centres should systematically distribute ocean acidification data and metadata to the relevant information systems, notably the Ocean Carbon and Biogeochemistry Data Management Office (OCB-DMO; <http://ocb.whoi.edu/>), the Carbon Dioxide Information Analysis Centre (CDIAC; <http://cdiac.ornl.gov/>) and the Publishing Network for Geoscientific and Environmental Data (PANGAEA®; <http://www.pangaea.de/>) (section 15.5).
5. **Reporting data and metadata.**
  - Data and metadata should be prepared and submitted together and as much as possible in the same file, following the detailed guidelines given in section 15.6. Metadata must describe *who* measured *what*, *where*, *when* and *how*. Metadata about “*where*” and “*when*” are generally well documented, while metadata regarding the other questions are often overlooked. Metadata about “*who*” measured data are essential to ensure intellectual property rights. Metadata about “*what*” was measured and “*how*” are essential to harmonise data and gain confidence in the quality of meta-analyses performed on them (section 15.6).
  - Research programmes on ocean acidification must allocate funding to data management, hiring a person (data curator) to help scientists preparing and submitting their data, to aggregate datasets that are related but come from different sources, and to submit/import data and metadata into a database (section 15.6).
6. **Avoiding pitfalls and addressing challenges.** It is recommended to create a scientific data infrastructure for ocean acidification with the overall goal to facilitate the end-to-end flow of data and information within the scientific community, and to stakeholders and policy makers. The central components of this scientific data infrastructure are a number of “Expert Groups” that include representatives of the observing community (field and laboratory scientists), data management community, and modelling community. Initially, we propose three expert groups based on the chapter structure of the present guide, i.e. seawater carbonate chemistry, perturbation experiments, and CO<sub>2</sub>-sensitive processes. The infrastructure could be coordinated by the IOCCP and the IOC/IODE (section 15.7).

### 15.9 References

- Dickson A. G., Sabine C. L. & Christian J. R. (Eds.), 2007. Guide to best practices for ocean CO<sub>2</sub> measurements. *PICES Special Publication 3*:1-191.
- Hook L. A., Beaty T. W., Santhana-Vannan S., Baskaran L. & Cook R. B., 2007. Best practices for preparing environmental data sets to share and archive. Environmental Sciences Division, Oak Ridge National Laboratory. USA.
- IODE Group of Experts on Biological and Chemical Data Management and Exchange (GE-BICH), 2009. Fourth Session, 27 – 30 January 2009. Reports of meetings of experts and equivalent bodies. 54 p. Paris: UNESCO.
- Kresse W. & Fadaie K., 2004. *ISO standards for geographic information*. 322 p. Berlin: Springer-Verlag.
- Lavigne H. & Gattuso J.-P., 2010. Seacarb: calculates parameters of the seawater carbonate system. R Package 2.3 (portions of code were contributed by J.-M. Epitalon, A. Hofmann, B. Gentili, J. Orr, A. Proye & K. Soetart). <http://cran.at.r-project.org/web/packages/seacarb/index.html>.
- Lewis E. & Wallace D. W. R., 1998. Program developed for CO<sub>2</sub> system calculations. Oak Ridge, Tennessee: ORNL/CDIAC-105. Carbon Dioxide Information Analysis Center, Oak Ridge National Laboratory, U.S. Department of Energy. <http://cdiac.ornl.gov/oceans/co2rprt.html>





## How to obtain EU publications

### Publications for sale:

- via EU Bookshop (<http://bookshop.europa.eu>);
- from your bookseller by quoting the title, publisher and/or ISBN number;
- by contacting one of our sales agents directly. You can obtain their contact details on the Internet (<http://bookshop.europa.eu>) or by sending a fax to +352 2929-42758.

### Free publications:

- via EU Bookshop (<http://bookshop.europa.eu>);
- at the European Commission's representations or delegations. You can obtain their contact details on the Internet (<http://ec.europa.eu>) or by sending a fax to +352 2929-42758.

European Commission

### **EUR 24328 – Guide to best practices for ocean acidification research and data reporting**

Luxembourg: Publications Office of the European Union

2010 – 260 pp. – 21,0 x 29,7 cm

ISBN 978-92-79-11118-1

doi 10.2777/58454

Riebesell U., Fabry V. J., Hansson L. & Gattuso J.-P. (Eds.), 2010. Guide to best practices for ocean acidification research and data reporting, 260 p. Luxembourg: Publications Office of the European Union.

### **Erratum**

- **26 August 2010:** an error was found in the maximum pH value reported in table 3.1. All calculations have been checked, and the table and its legend corrected. The pdf files of the full guide and chapter 3 have been corrected today. Files downloaded at an earlier date must take into account the revised table and legend appended.



Parameter	Mean (present-day)	Observed range (present-day)	Units	Notes
[DIC]	2017	1837 to 2204	$\mu\text{mol kg}^{-1}$	strong variation with latitude
[ $A_T$ ]	2305	2171 to 2458	$\mu\text{mol kg}^{-1}$	moderate spatial variability
[ $\text{CO}_3^{2-}$ ]	207	80 to 303	$\mu\text{mol kg}^{-1}$	strong variation with latitude
$\Omega_c$	5	1.9 to 9.2		strong variation with latitude
$\Omega_a$	3.3	1.2 to 5.4		strong variation with latitude
pH	8.10	7.91 to 8.46		strong spatial variability
p( $\text{CO}_2$ )	366	127 to 567	$\mu\text{atm}$	strong spatial variation
[ $\text{Ca}^{2+}$ ]	10600		$\mu\text{mol kg}^{-1}$	little spatial or seasonal variation
[ $\text{Mg}^{2+}$ ]	55000		$\mu\text{mol kg}^{-1}$	little spatial or seasonal variation
Temp.	18.7	-1.9 to 29.6	$^{\circ}\text{C}$	strong variation with latitude
Salinity	34.8	10.8 to 37.5	-	moderate spatial variation
[ $\text{PO}_4^{3-}$ ]	0.53	0.02 to 2.11	$\mu\text{mol kg}^{-1}$	strong variation with latitude
[ $\text{SiO}_2$ ]	7.35	0.37 to 101	$\mu\text{mol kg}^{-1}$	high in Southern Ocean

**Table 3.1** Mean and range of variation in the main ocean carbonate system parameters over open ocean surface waters of the world. This table can be used as a reference in the design of experiments including near present-day (1990's) carbonate system values (future conditions will obviously differ for some parameters). The ranges of total dissolved inorganic carbon (DIC) and total alkalinity ( $A_T$ ) are from the gridded GLODAP database (Key *et al.*, 2004) and represent surface water (0 and 10 m) of the open ocean, i.e. excluding coastal, shelf, and enclosed seas, near-shore, and estuarine environments. Other carbonate system parameters were calculated from DIC and  $A_T$  using the *seacarb* software (see main text); temperature (Stephens *et al.*, 2001) and salinity (Boyer *et al.*, 2001) were taken from the World Ocean Atlas (Antonov *et al.*, 2006; Garcia *et al.*, 2006; Locarnini *et al.*, 2006) database. The mean values are weighted averages according to the surface areas of the grid cells. Mean pH was calculated from mean  $[\text{H}^+]$ .

The goal of this chapter is to provide an overview of factors that influence the choice of atmospheric  $\text{CO}_2$  levels used in ocean acidification studies, based on experimental design, target environments, location, and analytical approach. The overriding philosophy for these guidelines is that ocean acidification research should attempt to provide predictive capabilities concerning the response of the oceans, including its physics, biochemistry, and biology, to a realistic range of future atmospheric p( $\text{CO}_2$ ) levels.

### 3.2 Approaches and methodologies

We investigate the issue of target levels of atmospheric p( $\text{CO}_2$ ), discuss the conversion of atmospheric values into equivalent parameters of ocean carbonate chemistry, and then provide recommendations depending on the number of treatment levels that can be manipulated.