



NOAA Technical Memorandum, OAR AOML-

**SPATIAL DISTRIBUTION OF PETROLEUM HYDROCARBONS IN
BLIND PASS SEDIMENT CORES**

C. Featherstone
J. Proni
T. Carsey
C. Brown
M. Adler
P. Blackwelder
H. Alsayegh
T. Hood
C. Piela
D. McCorquodale

Atlantic Oceanographic and Meteorological Laboratory
Miami, Florida

March 2009

noaa

**NATIONAL OCEANIC AND
ATMOSPHERIC ADMINISTRATION**

**Office of Oceanic and
Atmospheric Research**

NOAA Technical Memorandum, OAR-AOML-

**SPATIAL DISTRIBUTION OF PETROLEUM HYDROCARBONS IN
BLIND PASS SEDIMENT CORES**

Charles M. Featherstone
NOAA/Atlantic Oceanographic and Meteorological Laboratory, Miami, Florida

John R. Proni
NOAA/Atlantic Oceanographic and Meteorological Laboratory, Miami, Florida

Thomas P. Carsey
NOAA/Atlantic Oceanographic and Meteorological Laboratory, Miami, Florida

Cheryl J. Brown
NOAA/Atlantic Oceanographic and Meteorological Laboratory, Miami, Florida

Madeleine M. Adler
NOAA/Atlantic Oceanographic and Meteorological Laboratory, Miami, Florida

Patricia L. Blackwelder
University of Miami/Rosenstiel School of Marine and Atmospheric Science,
Miami, Florida

Husain Alsayegh
University of Miami/Center for Advanced Microscopy, Miami, Florida

Teresa A. Hood
University of Miami, Department of Geological Sciences, Miami, Florida

Christina Piela
University of Miami, Department of Geological Sciences, Miami, Florida

Donald S. McCorquodale
Florida Spectrum Environmental Services, Inc., Fort Lauderdale, Florida

March 2009



**UNITED STATES
DEPARTMENT OF COMMERCE**
**To be announced
Secretary**

NATIONAL OCEANIC AND
ATMOSPHERIC ADMINISTRATION
To be announced
Undersecretary for Oceans and
Atmosphere/Administrator

Office of Oceanic and
Atmospheric Research
Dr. Richard W. Spinrad
Assistant Administrator

Disclaimer

NOAA does not approve, recommend, or endorse any proprietary product or material mentioned in this document. No reference shall be made to NOAA or to this document in any advertising or sales promotion which would indicate or imply that NOAA approves, recommends, or endorses any proprietary product or proprietary material herein or which has as its purpose any intent to cause directly or indirectly the advertised product to be used or purchased because of this document.

The findings and conclusions in this report are those of the authors and do not necessarily represent the views of the funding agency.

Table of Contents

List of Figures	iv
List of Tables	viii
List of Acronyms	ix
Abstract	1
1. Introduction	2
2. Background	2
3. Site Location and Description	3
4. Methods	4
4.1 Sediment Core Collection	4
4.2 Sediment Sampling for Petroleum Hydrocarbons	5
4.3 <i>Bouchard 155</i> Reference Sample.....	5
4.4 C ₈ -C ₄₀ Total Petroleum Hydrocarbon Analysis (FL-PRO Methodology).....	5
4.5 Petroleum Hydrocarbon Speciation Analysis	6
4.6 Fuel Fluorescence Detection (FFD) Probe	7
5. Results	8
5.1 C ₈ -C ₄₀ Total Petroleum Hydrocarbons	8
5.2 Aromatic and Aliphatic Fractions.....	16
5.3 Reference Sample Petroleum Hydrocarbon Speciation.....	19
5.4 Field Sample Petroleum Hydrocarbon Speciation.....	19
5.5 Threshold Effective and Possible Effective Level (TEL and PEL) Results	32
5.5.1 High Molecular Weight Hydrocarbons.....	32
5.5.2 Low Molecular Weight Hydrocarbons	32
5.6 Spatial Distribution of C ₈ -C ₄₀ Total Petroleum Hydrocarbons.....	38
5.7 FFD Probe Analysis.....	43
6. Discussion.....	50
7. Conclusions.....	53
8. Acknowledgments.....	55
9. References.....	56
Appendix A.....	57
Appendix B.....	192
Appendix C.....	219
Appendix D.....	224

List of Figures

Figure 1.	Aerial photograph of Blind Pass, John’s Pass, and Boca Ciego Bay (Wang <i>et al.</i> , 2007).	4
Figure 2.	Photograph of the FFD and Data Pack 2000 system.	7
Figure 3.	Sediment core collection sites at Blind Pass.....	9
Figure 4.	C ₈ -C ₄₀ total petroleum hydrocarbon concentrations of all above-detection level samples.	14
Figure 5.	C ₈ -C ₄₀ total petroleum hydrocarbon concentrations for all above-detection level samples excluding the anomalously high sample BP-81 (312-317 cm)	15
Figure 6.	Blind Pass C ₈ -C ₄₀ average total petroleum hydrocarbon concentrations	15
Figure 7.	Concentration of aliphatic fractions for all samples with petroleum hydrocarbon levels above detection.....	16
Figure 8.	Aliphatic fractions for all samples above detection excluding BP-81 (312-317 cm).	17
Figure 9.	<i>Bouchard 155</i> reference sample aliphatic concentration.....	17
Figure 10.	Aromatic fractions for samples with petroleum hydrocarbon levels above detection	18
Figure 11.	Aromatic fractions in the <i>Bouchard 155</i> reference sample	18
Figure 12.	<i>Bouchard 155</i> reference sample concentration of all petroleum hydrocarbons.....	19
Figure 13.	Non-volatile petroleum hydrocarbons in the <i>Bouchard 155</i> reference sample	20
Figure 14.	Sample BP-97 (192-197 cm) from the North Channel of Blind Pass contained phthalates and low concentrations of ketones and toluene	20
Figure 15.	A: Blind Pass Mid Channel speciation data indicating concentrations of ether and ketone in BP-59 (186-191 cm)	21
Figure 15.	B: Evidence of phthalates and low concentrations of ketones and toluene in BP-70 (24-26 cm and 236-240 cm) from the Mid Channel of Blind Pass.....	22

List of Figures (continued)

Figure 15.	C: Evidence of ether in a Mid Channel near-surface horizon in core BP-76. However, several heavier petroleum hydrocarbons are evident deeper in the core.....	22
Figure 16.	A: Individual petroleum hydrocarbon speciation of BP-39 (168-178 cm, 231-238 cm, and 256-266 cm) from the South Channel of Blind Pass	23
Figure 16.	B: Individual petroleum hydrocarbon speciation of BP-81 (250-260 cm, 312-317 cm, and 328-338 cm) from the South Channel of Blind Pass	24
Figure 16.	C: Ether was the major component in a near surface sample in BP-82 (36-40 cm) from a South Channel core in Blind Pass	26
Figure 16.	D: Individual petroleum hydrocarbon speciation of BP-83 (70-75 cm) from the South Channel of Blind Pass.....	26
Figure 17.	A: Individual petroleum hydrocarbon speciation of BP-24 (116-121 cm, 293-294 cm, and 359-360 cm) from the Shoal area of Blind Pass	27
Figure 17.	B: Individual petroleum hydrocarbon speciation of BP-26 (262-263 cm) from the Shoal area of Blind Pass	27
Figure 17.	C: Individual petroleum hydrocarbon speciation of BP-31 (183-188 cm, 214-219 cm, and 265-271 cm) from the Shoal area of Blind Pass	28
Figure 17.	D: Individual petroleum hydrocarbon speciation of BP-45 (189-194 cm, 225-230 cm, and 266-272 cm) from the Shoal area of Blind Pass.....	28
Figure 17.	E: Individual petroleum hydrocarbon speciation of BP-91 (238-243 cm) from the Shoal area of Blind Pass	30
Figure 18.	A: Individual petroleum hydrocarbon speciation of BP-C (256-261 cm) from the Outside area of Blind Pass	30
Figure 18.	B: Individual petroleum hydrocarbon speciation of BP-88 (215-217 cm) from the Outside area of Blind Pass	31
Figure 18.	C: Individual petroleum hydrocarbon speciation of BP-90 (221-223 cm) from the Outside area of Blind Pass	31
Figure 19.	Concentrations of benzo(a)anthracene in Blind Pass cores.....	33
Figure 20.	Concentrations of benzo(a)pyrene in Blind Pass cores	33
Figure 21.	Concentrations of pyrene in Blind Pass cores	34

List of Figures (continued)

Figure 22.	Concentrations of chrysene in Blind Pass cores	34
Figure 23.	Concentrations of fluoranthene in Blind Pass cores	35
Figure 24.	Concentrations of phenanthrene in Blind Pass cores	35
Figure 25.	Concentrations of acenaphthylene in Blind Pass cores	36
Figure 26.	Concentrations of fluorene in Blind Pass cores	36
Figure 27.	Concentrations of anthracene in Blind Pass cores	37
Figure 28.	Concentrations of acenaphthene in Blind Pass cores	37
Figure 29.	Concentrations of bis(2 ethylhexyl)phthalate in Blind Pass cores	38
Figure 30.	Spatial distribution of total petroleum hydrocarbons at the 0-99 cm depth interval in Blind Pass	39
Figure 31.	Spatial distribution of total petroleum hydrocarbons at the 100-199 cm depth interval in Blind Pass	40
Figure 32.	Spatial distribution of total petroleum hydrocarbons at the 200-299 cm depth interval in Blind Pass	41
Figure 33.	Spatial distribution of total petroleum hydrocarbons at the 300-399 cm depth interval in Blind Pass	42
Figure 34.	Average fluorescence of sediment types from Blind Pass using the FFD probe	43
Figure 35.	FFD probe analysis of sediment core BP-97	44
Figure 36.	FFD probe analysis of sediment core BP-35	44
Figure 37.	FFD probe analysis of sediment core BP-59	45
Figure 38.	FFD probe analysis of sediment core BP-70	45
Figure 39.	FFD probe analysis of sediment core BP-73	45
Figure 40.	FFD probe analysis of sediment core BP-76	45
Figure 41.	FFD probe analysis of sediment core BP-82	46

List of Figures (continued)

Figure 42.	FFD probe analysis of sediment core BP-1	46
Figure 43.	FFD probe analysis of sediment core BP-39	46
Figure 44.	FFD probe analysis of sediment core BP-24	46
Figure 45.	FFD probe analysis of sediment core BP-26	47
Figure 46.	FFD probe analysis of sediment core BP-31	47
Figure 47.	FFD probe analysis of sediment core BP-40	47
Figure 48.	FFD probe analysis of sediment core BP-45	47
Figure 49.	FFD probe analysis of sediment core BP-86	48
Figure 50.	FFD probe analysis of sediment core BP-91	48
Figure 51.	FFD probe analysis of sediment core BP-C	48
Figure 52.	FFD probe analysis of sediment core BP-57	48
Figure 53.	FFD probe analysis of sediment core BP-88	49
Figure 54.	FFD probe analysis of sediment core BP-90	49
Figure 55.	FFD probe analysis of sediment core BP-81	49
Figure 56.	FFD probe analysis of sediment core BP-83	49

List of Tables

Table 1.	Examples of typical FFD responses to certain hydrocarbon contamination (Vertek, 2007).....	8
Table 2.	Petroleum hydrocarbon concentrations in Blind Pass cores	10
Table 3.	Average fluorescence of sediment types from Blind Pass.....	43

List of Acronyms

AOML	Atlantic Oceanographic and Meteorological Laboratory
FDEP	Florida Department of Environmental Protection
FFD	Fuel fluorescence detector
FID	Flame ionization detector
FL-PRO	Florida petroleum residual organic
GC	Gas chromatography
MS	Mass spectroscopy
NOAA	National Oceanic and Atmospheric Administration
PEL	Possible effective level
PMT	Photomultiplier tubes
RSMAS	Rosenstiel School of Marine and Atmospheric Science
TEL	Threshold effective level
USACE	U.S. Army Corps of Engineers
USF	University of South Florida
UV	Ultraviolet

**Spatial Distribution of Petroleum Hydrocarbons in
Blind Pass Sediment Cores**

*Charles M. Featherstone, John R. Proni, Thomas P. Carsey, Cheryl J. Brown,
Madeleine M. Adler, Patricia L. Blackwelder, Husain Alsayegh, Teresa A. Hood,
Christina Piela, and Donald S. McCorquodale*

Abstract

One hundred and one sediment corChar12.3 TD Feaaise(sain Alsay Tc .0015 T TD -kw)]TJ 2

1. Introduction

Recently-developed technologies for the detection of petroleum hydrocarbons for terrestrial applications such as fuel fluorescence detection (FFD) have been examined for coastal marine application by the Atlantic Oceanographic and Meteorological Laboratory (AOML) of the National Oceanic and Atmospheric Administration (NOAA). In conjunction with these studies, petroleum hydrocarbon characterization and calibration studies using GC/FID and GC/MS were conducted by researchers with the University of Miami's Rosenstiel School of Marine and Atmospheric Science (RSMAS). Application of terrestrial oil detection technologies may be suitable for characterizing the presence of petroleum hydrocarbons in submerged sediment in the coastal ocean and adjacent waterways. AOML is interested in understanding the utility of these technologies for: (1) utilizing a fluorescence method (FFD probe) to rapidly detect petroleum hydrocarbons; and (2) coordinating the use of total petroleum hydrocarbon and speciation methods for characterization of sediment levels and spatial distributions in the marine coastal environment.

A site at which the above technologies have particular application is in Blind Pass, Tampa Bay, Florida. In 1993, a collision occurred between three vessels which resulted in an oil spill in Tampa Bay, Florida. Subsequently, large thick mats of oil were found inside the entrances to Blind and John's Passes. Prior to dredging in 2000, the U.S. Army Corps of Engineers (USACE) obtained sediment cores to examine the sediment before initiating dredging operations. Numerous sediment cores were collected in the Blind Pass navigation channel in January 2000, and one of the sediment cores revealed the presence of a "gasoline-like" substance. No other sediment cores that were visually examined exhibited such a substance, and no quantitative techniques were applied for the characterization of the sediments collected. The use of FFD, GC/FID, and GC/MS to analyze sediment core samples represents a significant advance over prior petroleum hydrocarbon characterization in Blind Pass. The utilized approach applies new technology to make quantitative, science-based decisions as to the presence of above-detection levels of petroleum hydrocarbons in Blind Pass sediment.

The present work was conducted in anticipation of future Blind Pass dredging operations. As part of this effort, sediment cores were collected by the University of South Florida (USF) and analyzed by AOML and RSMAS using the above-mentioned technologies. The objectives of the investigation were to determine: (1) the utility of the FFD probe in assessing petroleum hydrocarbons in coastal marine environments; (2) characterization of intra-core petroleum hydrocarbon levels in sediment; and (3) depiction of the spatial distribution and individual hydrocarbon speciation of these petroleum hydrocarbons within Blind Pass.

2. Background

On August 10, 1993, a collision of tanker barges resulted in the discharge of approximately 330,000 gallons of No. 6 fuel oil from the *Bouchard 155* and about 32,000 gallons of Jet A, diesel, and gasoline oil from the *Ocean 255* into lower Tampa Bay. There was some initial oiling of exposed beaches, sea grass beds, and mangroves in lower Tampa Bay, but winds and currents carried most of the oil into the open waters of the Gulf of Mexico in the first few days after the spill. This oil, however, came ashore on August 14-15, 1993 during a strong storm front and was deposited on the sandy beaches of the barrier island communities and moved through inlets into

Boca Ciega Bay. The incident resulted in oiling of birds, sea turtles, mangroves, salt marshes, sea grasses, mud flats, oyster beds, and seawalls in the finger canals within Boca Ciega Bay and miles of shoreline, including sandy recreational beaches. Some of the fuel oil sank, forming mats on submerged sediments in offshore depressions, in passes such as Blind Pass and in Boca Ciega Bay (Urquhart-Donnelly *et al.*, 2000).

In late 1999, the USACE and Pinellas County initiated two projects to maintenance dredge John's and Blind Passes, and to use the beach-quality sand removed from these passes to renourish beaches at Upham Beach (St. Pete Beach) and Sunset Beach (Treasure Island). In accordance with their project permits, 15 geotechnical borings were conducted in both passes to determine the sand quality and identify any areas of unsuitable material. These borings produced no clear indication of the presence of residual oil, with only one boring from within Blind Pass exhibiting a fuel odor.

Dredging activities in Blind Pass began in January 2000, with sand placed on Upham Beach. During these activities, small pockets of petroleum hydrocarbons, approximately 50 gallons each, were discovered. The U.S. Coast Guard initiated oil containment and cleanup of this oil after cessation of dredging activities. The oil recovered was No. 6 fuel oil, the same type as spilled in 1993. The dredging project was put on standby pending further discussions among the governmental agencies as to the responsibility and funding for response or mitigation actions to address this found oil.

As these discussions proceeded, the U.S. Coast Guard requested that additional borings be made within Blind Pass. From January 19-24, 2000, 50 additional cores were taken which provided a more detailed map of where residual oil pockets were located. An Assessment Team recommended continuation of the dredging project in Blind Pass as the best method for removal of the submerged oil. Dredging operations resumed on February 2, 2000, and approximately 20,000 gallons of oil/water were recovered. The condition of this submerged oil after almost seven years in the natural environment is technically noteworthy. When found, the oil was still fairly fluid, producing sheens and releasing volatile or aromatic fractions. Substantial degradation due to aerobic or anaerobic processes was not evident (Urquhart-Donnelly *et al.*, 2000).

3. Site Location and Description

Blind Pass is located along the west-central Florida coast (Figure 1). It is a shallow pass that connects the Gulf of Mexico to Boca Ciega Bay between the north end of Long Key and Treasure Island.



Figure 1: Aerial photograph of Blind Pass, John's Pass, and Boca Ciega Bay (Wang et al., 2007).

4. Methods

4.1 Sediment Core Collection

Sediment cores were collected by Dr. Ping Wang of the University of South Florida's (USF) Department of Geology. A lightweight, portable vibracore system was used to collect the sediment cores. A 20-foot long, 3-inch diameter aluminum tube was pushed into the sediment by vibration. After maximum penetration of the core tube was achieved, the vibrator head was turned off and removed. The length of the core tube was measured on the inside and outside. The core tube was capped with a vacuum sealer plug to prevent sediment loss upon retrieval. Extraction of the core tube was accomplished by overlapping a chain to the core tube and attaching the chain to a pulley system mounted to a tripod and pulling the core tube out of the seabed. During extraction, the core tube was kept as vertical as possible. A diver capped the bottom of the core tube as it exited the seabed to prevent loss of sediment. Once on deck, the vacuum plug was removed and excess water drained from the core tube. Excess core tube was removed and both ends were sealed with caps and the caps secured with duct tape. The sediment core was then labeled with the station designation and stored for transport back to the USF Geology Laboratory.

4.2 Sediment Sampling for Petroleum Hydrocarbons

In the USF Geology Laboratory, core tubes were longitudinally cut with a circular saw and carefully split into two halves. Each half was placed in a pre-labeled polyurethane bag and sealed. One-half of each sediment core was retained by USF for grain size and other sediment analyses, while the other half was transported to AOML in Miami, Florida for petroleum hydrocarbon analysis.

At AOML, split sediment cores were placed in a trough and the total core length measured. Sediment types in each core were described and, during description, cores were visually examined for petroleum hydrocarbons. Areas exhibiting visual evidence of petroleum hydrocarbon contamination were sampled. In addition, one or more samples were collected from most of the cores. The sediment cores were measured from the top of the core (surface) to the area being sampled to record sample depth, and the sample was then extracted from within the sediment core. Each sample area was photographed before sediment removal. The sediment was extracted from each core with a clean metal spatula and placed in a pre-cleaned, labeled jar with a Teflon lid. Samples were stored at 4°C until analysis for total petroleum hydrocarbons (C₈-C₄₀) by GC/FID and subsequent speciation studies of above-detection samples using GC/MS could be performed.

4.3 *Bouchard 155* Reference Sample

An oil sample from the *Bouchard 155*'s tank 7 was collected in 1993 just after the Tampa Bay oil spill. A sub-sample was obtained from the Louisiana State University's Department of Environmental Studies in September 2007. This sample was useful in comparing petroleum hydrocarbon speciation data with field samples.

4.4 C₈-C₄₀ Total Petroleum Hydrocarbon Analysis (FL-PRO Methodology)

The original scope and application of this method was to give an accurate concentration of petroleum hydrocarbons in environmental soil samples. The method has been modified for marine sediment samples in the alkane range of C₈-C₄₀. The components of interest are listed below:

Octane	(C8)	Hexacosane	(C26)
Decane	(C10)	Octacosane	(C28)
Dodecane	(C12)	Triacontane	(C30)
Tetradecane	(C14)	Dotriacontane	(C32)
Hexadecane	(C16)	Tetratriacontane	(C34)
Octadecane	(C18)	Hexatriacontane	(C36)
Eicosane	(C20)	Octatriacontane	(C38)
Docosane	(C22)	Tetracontane	(C40)
Tetracosane	(C24)		

A specified weight of sediment sample was spiked with two surrogates and extracted with methylene chloride. The sediment extract was then concentrated to a volume of 1.0 ml and treated with silica gel to remove potential organic interference. An aliquot was injected into a capillary column gas chromatograph equipped with a flame ionization detector. Quantification was based on the detector response compared to a series of alkane standards. A Hewlett Packard 5890/MSD 5973 with an auto-sampler gas chromatograph and a Hewlett Packard DB-5MS, 30 m × 530 μm × 1.0 μm flame ionization detector was used for the C₈-C₄₀ analyses.

The integrated area for all peaks eluting from C₈-C₄₀ was determined using a baseline drawn from the baseline point prior to n-octane to a point past n-tetracontane where the baseline lowers. All areas including the “hump-a-gram” and surrogate standards were included. The concentration was determined by calibration factor calculations or by linear regression as listed in the Florida Department of Environmental Protection’s (FDEP) Florida Petroleum Residual Organic (FL-PRO) methods, sections 9.6.2 and 9.6.3. The time window and pattern of integration was constant for all standards and samples. The area of the surrogates was then subtracted from the samples. Detection levels were routinely 0.01 mg/Kg. Calculations were as follows:

$$\text{Result} = (y - b) \div m$$

where: y = area of sample – area of surrogate;

b = y – intercept from calibration curve; and

m = slope from the calibration curve.

Results of sediment samples converted from mg/L to mg/Kg were as follows:

$$\text{Result} = X \text{ mg/L} \times (25 \text{ L/Kg} \div \% \text{ solid}/100) \times D$$

where: X = result (mg/L);

25 L/Kg = 40 g (1 Kg ÷ 1000 g) = 0.001 L ÷ 0.04 Kg;

% solid = % moisture – 100 from Metals Department; and

D = dilution factor (if any).

4.5 Petroleum Hydrocarbon Speciation Analysis

Petroleum hydrocarbon speciation was performed according to FDEP methods 8260 and 8270. Extracts were analyzed employing two mass spectrometers: an 890 Agilent for the 8260 method and a 5973 Agilent for 8270 method for polycyclic aromatic hydrocarbons. Chromatograms were then converted into tabular formats and both chromatograms and tables were used for data interpretation. Detection levels varied with petroleum hydrocarbon but were routinely in the 1-5 μg /Kg range.

4.6 Fuel Fluorescence Detection (FFD) Probe

The FFD is based on fluorescence which, when certain substances are exposed to ultraviolet (UV) light, radiate light at different discrete wavelengths. The sensor module of the FFD contains a mercury vapor UV lamp that emits through a sapphire window on the side of the module. The UV light is absorbed by the material in the sediments which come in direct contact with the window. If fluorescing chemicals are present in the sediments, a portion of the UV lamp energy absorbed by the chemicals will be re-radiated at wavelengths specific to the compounds present. The re-radiated fluorescence is collected and detected with two photomultiplier tubes (PMTs). Optical filters configured in front of the PMTs are used to isolate fluorescence emission wavelengths corresponding to the pollutants of interest. The PMTs produce a voltage signal proportional to the amplitude of the radiated light (Figure 2, Table 1). The standard filter configuration enables the detection of fluorescence in two spectral regions: 280-450 nm (LFFD, lighter hydrocarbons) and >450 nm (HFFD, heavy hydrocarbons). While the FFD may be a useful screening method for hydrocarbons, it does not produce laboratory quality analytical results. The output of the FFD is influenced by specific site conditions. The natural “background” fluorescence of native sediments will vary, and dark-colored soils produce lower outputs for the same contamination levels than lighter-colored sediments (Vertek, 2007).

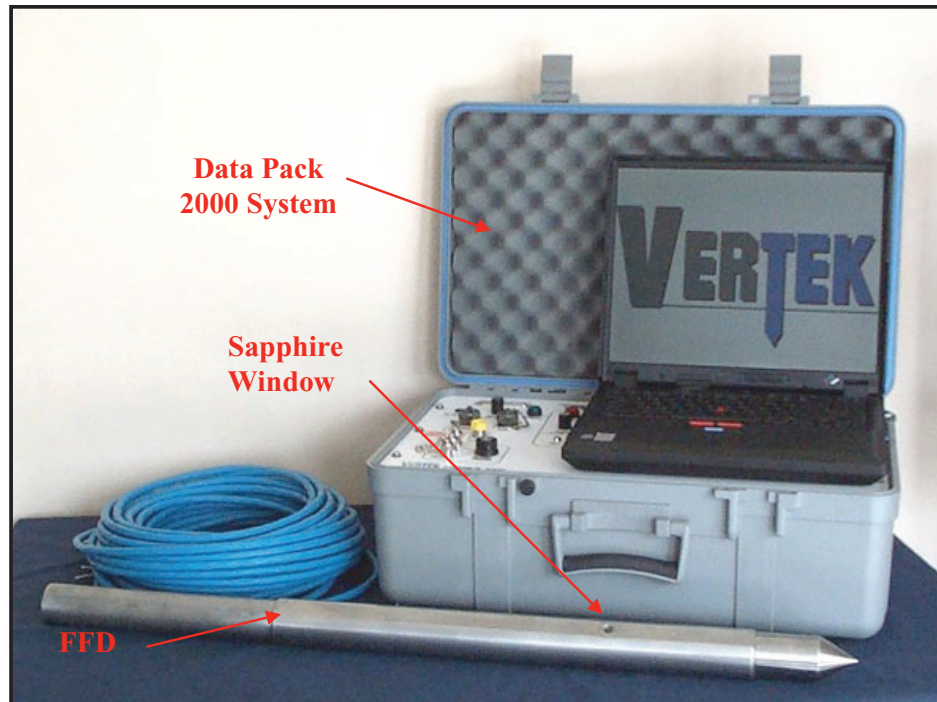

Figure 2: Photograph of the FFD and the Data Pack 2000 system.

A series of different sediment types found in the test cores, i.e., clays, shell layers, quartz sand, etc., were analyzed by the FFD to determine background levels of fluorescence. Fluorescence peaks (measured in volts) were generated as the FFD was pushed along the length of the split sediment core. When above-background levels were detected, samples were collected for C₈-C₄₀ analyses and extracts of these used for GC/MS speciation.

Sample	Low Wavelength	High Wavelength	Ratio High/Low
Clean sand	0.01 VDC	0.01 VDC	1.0
Creosote (light extract)	<0.1 VDC	0.67 VDC	>6.7
Creosote (heavy extract)	<0.1 VDC	1.00 VDC	>10.0
Coal tar (neat liquid)	<0.1 VDC	1.10 VDC	>11.0
Crude oil on sand	3.1 VDC	3.10 VDC	1.0
Diesel on sand	3.1 VDC	0.55 VDC	0.18
Unleaded gasoline on sand	6.3 VDC	0.83 VDC	0.13

5. Results

Staff from the University of South Florida collected 101 sediment cores for the Blind Pass project (Figure 3). The grid pattern formed by these cores provided good spatial resolution of the study area and enabled a thorough sampling of the site to be performed.

5.1 C₈-C₄₀ Total Petroleum Hydrocarbons

A total of 141 sub-samples were collected for C₈-C₄₀ analysis. Thirty-five of the samples (25%) generally exhibited low, but above-detection levels for petroleum hydrocarbons. Above-detection level samples containing petroleum hydrocarbon concentrations ranged from 1.60-346.0 mg/Kg (Table 2). Note that in several cases levels were above or below detection at different horizons within the same core.

A total of 38 samples were analyzed for C₈-C₄₀ from sediment cores collected from Outside of the Pass. Five of these samples exhibited petroleum hydrocarbon concentrations above detection limits. Petroleum hydrocarbon concentrations ranged from 4.2-21.2 mg/Kg (Table 2, Figures 4 and 5).

In the Shoal area, a total of 33 samples were analyzed for C₈-C₄₀. Twelve of these samples exhibited petroleum hydrocarbon concentrations above detection limits. Petroleum hydrocarbon concentrations ranged from 2.5-110.0 mg/Kg (Table 2, Figures 4 and 5).

2007-2008 Blind Pass Vibracore

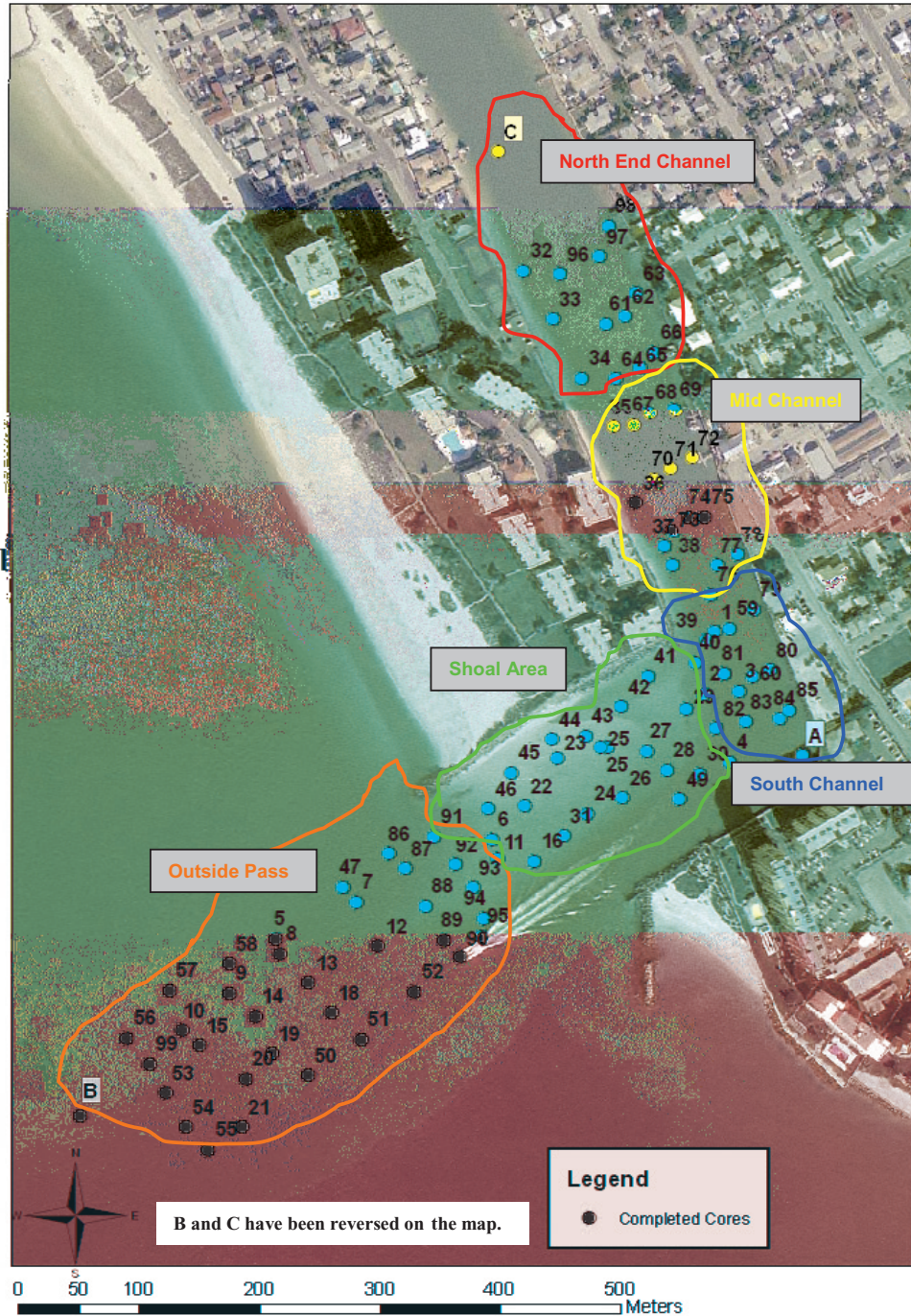

Figure 3: Sediment core collection sites at Blind Pass (Tanya Beck, USF).

Table 2: Petroleum hydrocarbon concentrations in Blind Pass cores (red bold highlight = above-detection level concentrations; U = below detection limits).

Sediment Core	Location	Sample Depth (cm)	Corrected Sample Depth (cm)	C ₈ -C ₄₀ (mg/Kg)
BP-C	Outside Pass	190-195	207-212	U
BP-C	Outside Pass	235-240	256-261	9.33
BP-5	Outside Pass	285-288	317-320	U
BP-7	Outside Pass	195-200	218-223	U
BP-7	Outside Pass	275-280	308-313	U
BP-9	Outside Pass	125-130	130-135	U
BP-12	Outside Pass	204-206	235-237	U
BP-13	Outside Pass	185-190	224-229	U
BP-14	Outside Pass	185-190	203-208	U
BP-15	Outside Pass	150-155	163-168	U
BP-16	Outside Pass	125-130	141-146	U
BP-18	Outside Pass	192-196	219-223	U
BP-19	Outside Pass	55-60	57-62	U
BP-19	Outside Pass	338-343	351-356	U
BP-20	Outside Pass	190-195	212-217	U
BP-50	Outside Pass	80-85	96-101	U
BP-50	Outside Pass	165-170	198-203	U
BP-51	Outside Pass	198-200	222-224	U
BP-52	Outside Pass	195-200	226-231	U
BP-53	Outside Pass	200-205	233-238	U
BP-54	Outside Pass	190-195	203-208	U
BP-57	Outside Pass	150-155	181-186	U
BP-57	Outside Pass	170-175	205-210	U
BP-57	Outside Pass	190-195	229-234	8.8
BP-57	Outside Pass	328-333	396-401	U
BP-86	Outside Pass	200-203	246-249	21.2
BP-86	Outside Pass	230-235	282-287	U
BP-87	Outside Pass	188-193	224-229	U
BP-88	Outside Pass	135-140	154-159	U
BP-88	Outside Pass	188-190	215-217	4.2
BP-88	Outside Pass	209-212	239-242	U
BP-89	Outside Pass	120-125	136-141	U
BP-90	Outside Pass	150-155	166-171	U
BP-90	Outside Pass	199-210	221-223	6.5
BP-92	Outside Pass	200-205	234-239	U

Table 2: Petroleum hydrocarbon concentrations in Blind Pass cores (red bold highlight = above-detection level concentrations; U = below detection limits).

Sediment Core	Location	Sample Depth (cm)	Corrected Sample Depth (cm)	C ₈ -C ₄₀ (mg/Kg)
BP-93	Outside Pass	211-214	243-246	U
BP-94	Outside Pass	170-174	209-213	U
BP-95	Outside Pass	200-205	236-241	U
BP-6	Shoal Area	135-140	170-175	U
BP-11	Shoal Area	95-100	127-132	U
BP-22	Shoal Area	225-230	319-324	U
BP-23	Shoal Area	370-375	449-454	U
BP-24	Shoal Area	85-90	94-99	U
BP-24	Shoal Area	105-110	116-121	5.68
BP-24	Shoal Area	264-265	293-294	21.7
BP-24	Shoal Area	324-325	359-360	14.2
BP-25	Shoal Area	295-300	347-352	U
BP-26	Shoal Area	132-133	161-162	U
BP-26	Shoal Area	215-216	262-263	5.7
BP-27	Shoal Area	335-340	390-395	U
BP-28	Shoal Area	78-83	90-95	U
BP-28	Shoal Area	178-183	205-210	U
BP-30	Shoal Area	145-150	201-206	U
BP-30	Shoal Area	200-205	277-282	U
BP-31	Shoal Area	155-160	183-188	2.57
BP-31	Shoal Area	181-184	214-219	5.9
BP-31	Shoal Area	225-228	259-262	U
BP-31	Shoal Area	231-235	265-271	9.8
BP-40	Shoal Area	80-90	109-119	4.13
BP-40	Shoal Area	203-205	276-281	U
BP-42	Shoal Area	230-235	296-301	U
BP-43	Shoal Area	210-214	275-279	U
BP-44	Shoal Area	253-257	299-303	U
BP-45	Shoal Area	160-165	189-194	3.54
BP-45	Shoal Area	190-195	225-230	14.6
BP-45	Shoal Area	225-230	266-272	110.0
BP-46	Shoal Area	205-210	227-232	U
BP-46	Shoal Area	225-235	249-259	U
BP-48	Shoal Area	95-200	240-245	U
BP-91	Shoal Area	180-190	214-224	U
BP-91	Shoal Area	200-205	238-243	2.5

Table 2: Petroleum hydrocarbon concentrations in Blind Pass cores (red bold highlight = above-detection level concentrations; U = below detection limits).

Sediment Core	Location	Sample Depth (cm)	Corrected Sample Depth (cm)	C ₈ -C ₄₀ (mg/Kg)
BP-1	South Channel	150-155	193-198	U
BP-1	South Channel	165-170	213-218	U
BP-1	South Channel	185-190	239-244	1.76
BP-1	South Channel	193-197	249-254	55.9
BP-4	South Channel	200-204	242-246	U
BP-4	South Channel	153-157	185-189	U
BP-4	South Channel	80-85	97-102	U
BP-39	South Channel	115-125	168-178	4.11
BP-39	South Channel	158-163	231-238	38.0
BP-39	South Channel	175-185	256-266	3.36
BP-59	South Channel	135-140	170-175	U
BP-60	South Channel	80-90	98-108	U
BP-60	South Channel	140-150	172-182	U
BP-79	South Channel	200-205	250-255	U
BP-79	South Channel	250-255	312-317	U
BP-80	South Channel	64-68	118-122	U
BP-81	South Channel	90-100	140-150	U
BP-81	South Channel	160-170	250-260	32.6
BP-81	South Channel	200-205	312-317	346.0
BP-81	South Channel	210-220	328-338	7.17
BP-82	South Channel	24-27	36-40	2.2
BP-82	South Channel	115-125	172-182	U
BP-83	South Channel	80-90	93-103	U
BP-83	South Channel	60-65	70-75	10.9
BP-83	South Channel	105-110	122-127	U
BP-84	South Channel	10-15	13-18	U
BP-85	South Channel	30-35	48-53	U
BP-2	Mid Channel	110-115	254-259	U
BP-3	Mid Channel	124-138	158-162	U
BP-35	Mid Channel	97-101	116-120	14.9
BP-35	Mid Channel	165-175	197-207	U
BP-35	Mid Channel	200-205	239-244	U
BP-36	Mid Channel	210-215	287-292	U
BP-37	Mid Channel	15-20	27-32	U
BP-38	Mid Channel	15-20	23-28	U
BP-49	Mid Channel	245-250	309-314	U

Table 2: Petroleum hydrocarbon concentrations in Blind Pass cores (red bold highlight = above-detection level concentrations; U = below detection limits).

Sediment Core	Location	Sample Depth (cm)	Corrected Sample Depth (cm)	C ₈ -C ₄₀ (mg/Kg)
BP-49	Mid Channel	343-347	433-437	U
BP-59	Mid Channel	148-152	186-191	2.7
BP-66	Mid Channel	65-70	103-108	U
BP-67	Mid Channel	240-245	288-293	U
BP-69	Mid Channel	72-75	126-129	U
BP-70	Mid Channel	9-14	11-19	U
BP-70	Mid Channel	19-21	24-26	66.3
BP-70	Mid Channel	26-31	32-37	U
BP-70	Mid Channel	190-195	236-241	2.93
BP-71	Mid Channel	19-21	29-31	U
BP-72	Mid Channel	140-145	274-279	U
BP-73	Mid Channel	25-30	48-53	6.77
BP-73	Mid Channel	155-165	294-304	U
BP-73	Mid Channel	190-195	361-366	U
BP-74	Mid Channel	110-115	120-125	U
BP-75	Mid Channel	20-25	27-32	U
BP-75	Mid Channel	128-133	172-177	U
BP-75	Mid Channel	148-153	199-204	U
BP-76	Mid Channel	54-56	78-81	1.6
BP-76	Mid Channel	155-160	224-229	7.01
BP-77	Mid Channel	156-162	184-189	U
BP-32	North End Channel	180-185	244-249	U
BP-34	North End Channel	220-225	281-286	U
BP-61	North End Channel	190-195	225-230	U
BP-62	North End Channel	155-160	167-172	U
BP-64	North End Channel	60-65	66-71	U
BP-64	North End Channel	120-125	131-136	U
BP-96	North End Channel	29-34	41-46	U
BP-97	North End Channel	180-185	192-197	30.6
BP-97	North End Channel	165-170	176-181	U
BP-97	North End Channel	200-205	213-218	U
BP-98	North End Channel	195-200	201-206	U
BP-B	North End Channel	45-50	54-59	U
BP-B	North End Channel	195-200	234-239	U

Twenty-seven samples were analyzed for C₈-C₄₀ from sediment cores collected from the South Channel region of Blind Pass. Ten of these samples exhibited petroleum hydrocarbon concentrations above detection limits. Petroleum hydrocarbon concentrations ranged from 1.76- to 346.0 mg/Kg (Table 2, Figures 4 and 5).

A total of 30 samples were analyzed for C₈-C₄₀ from the Mid Channel area of Blind Pass. Seven of these samples exhibited petroleum hydrocarbon concentrations above detection limits. Petroleum hydrocarbon concentrations ranged from 1.6-66.3 mg/Kg (Table 2, Figures 4 and 5).

Thirteen samples from the North Channel area of Blind Pass were analyzed for C₈-C₄₀. Only one sample exhibited petroleum hydrocarbon levels above detection limits. This sample had a petroleum hydrocarbon concentration of 30.6 mg/Kg (Table 2, Figures 4 and 5).

Average C₈-C₄₀ values for the five areas of Blind Pass are shown in Figure 6. The South Channel area exhibited the highest average concentration of C₈-C₄₀ petroleum hydrocarbons (19.9 mg/Kg). This is due in part to sample BP-81 (312-317 cm), which exhibited a concentration of 346.0 mg/Kg. The Shoal area contained the second highest average concentration of C₈-C₄₀ petroleum hydrocarbons (6.10 mg/Kg), followed by the Mid Channel (3.26 mg/Kg), North End Channel (2.55 mg/Kg), and Outside Pass (0.80 mg/Kg).

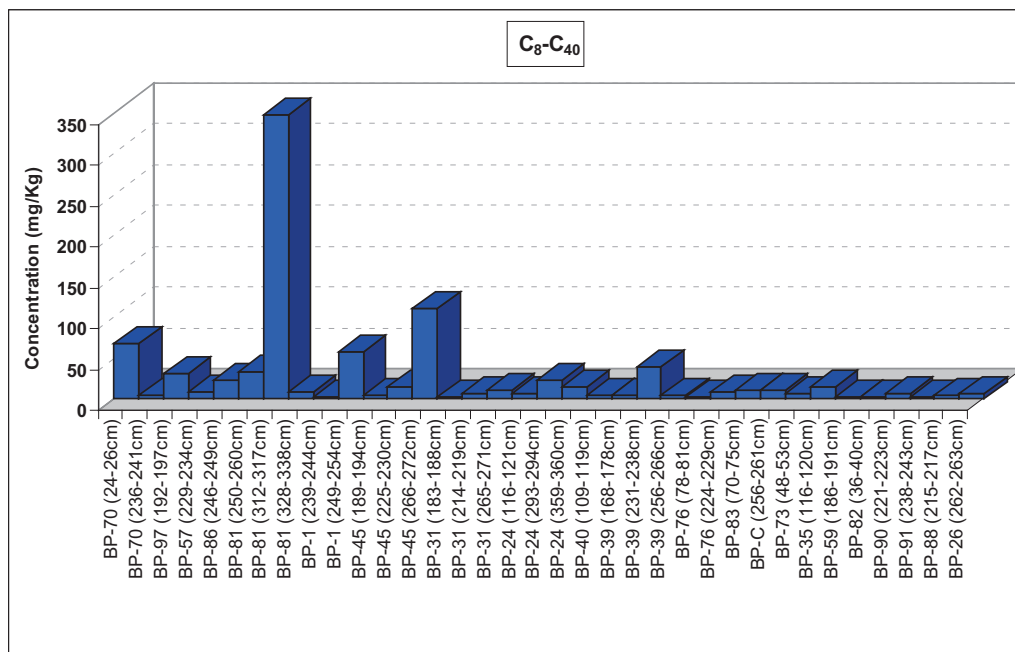

Figure 4: C₈-C₄₀ total petroleum hydrocarbon concentrations of all above-detection level samples.

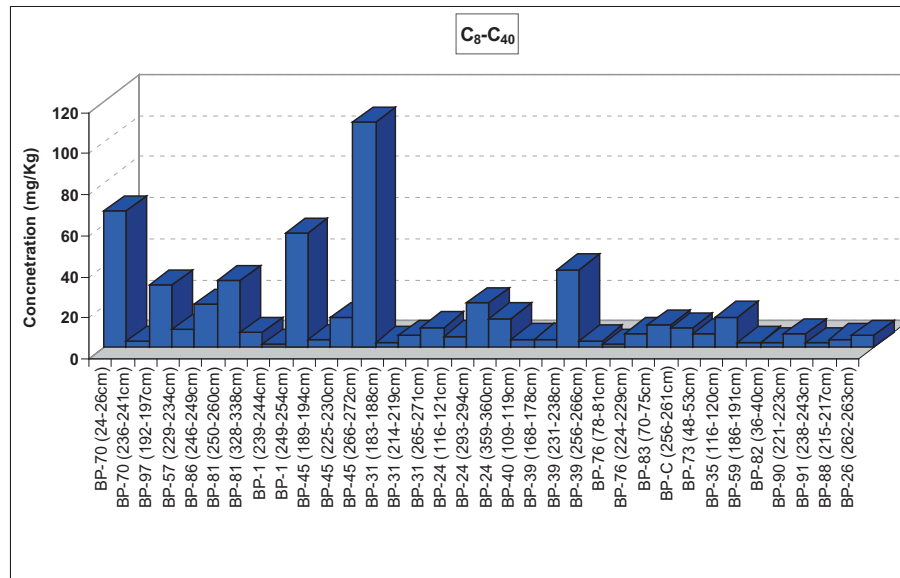

Figure 5: C₈-C₄₀ total petroleum hydrocarbon concentrations for all above-detection level samples excluding the anomalously high sample BP-81 (312-317 cm).

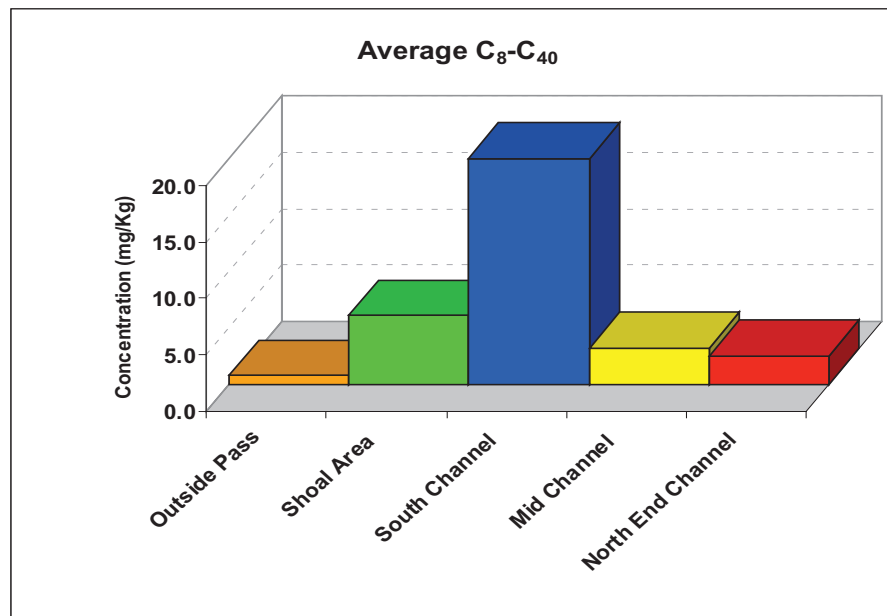

Figure 6: Blind Pass C₈-C₄₀ average total petroleum hydrocarbon concentrations.

5.2 Aromatic and Aliphatic Fractions

The South Channel area of Blind Pass contained samples with the highest concentrations of the aliphatic C₁₆-C₃₅ fraction and, within the South Channel, BP-81 (312-317 cm) exhibited the highest concentration of 357 mg/Kg (Figure 7). If the aliphatic concentrations are shown with BP-81 (312-317 cm) removed (Figure 8), the highest concentrations of the C₁₆-C₃₅ aliphatic fraction are still found in the South Channel, e.g., BP-81 (250-260 cm) at 32.6 mg/Kg and BP-39 (231-238 cm) at 38.0 mg/Kg. Only one sample from Outside the Pass, BP-1 (249-254 cm), contained measurable concentrations of the C₈-C₁₀ aliphatic fraction (99.2 µg/Kg). The *Bouchard 155* reference sample (Figure 9) exhibited very high concentrations of aliphatics. The highest concentration of aliphatics was in the C₁₆-C₃₅ fraction (160,000 mg/Kg), which was also the case in many of the sediment cores sampled.

The Shoal and South Channel areas of Blind Pass contained samples with the highest concentration of aromatic fractions. The highest concentrations of the aromatic C₁₂-C₁₆ fraction were found in Shoal samples BP-24 (293-294 cm) and BP-26 (262-263 cm) in which 73.6 and 56.8 µg/Kg were detected respectively (Figure 10). The highest concentrations of the aromatic C₁₆-C₂₁ fraction were found in the Shoal and South Channel samples BP-45 (225-230 cm) and BP-81 (312-317 cm), which contained 171 and 168 µg/Kg respectively (Figure 10). The highest concentration of the aromatic C₂₁-C₃₅ fraction, 61.6 µg/Kg, was found in sample BP-81 (312-317 cm) (Figure 10).

The *Bouchard 155* reference sample (Figure 11) exhibited high concentrations of aromatics. The highest concentration of aromatics was in the C₁₂-C₁₆ (19,920 mg/Kg) and C₁₆-C₂₁ (8,350 mg/Kg) fractions, which was also the case in many of the sediment cores sampled.

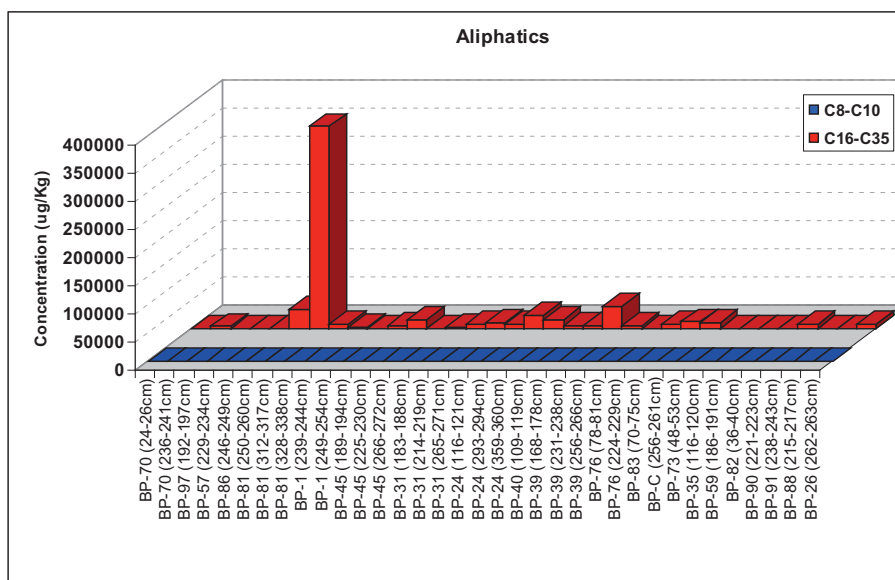

Figure 7: Concentration of aliphatic fractions for all samples with petroleum hydrocarbon levels above detection.

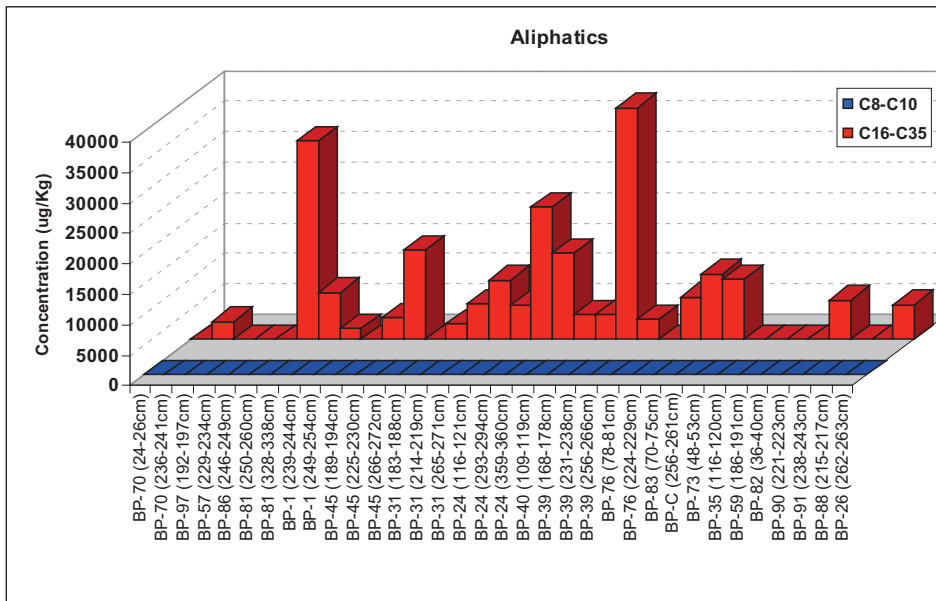

Figure 8: Aliphatic fractions for all samples above detection excluding BP-81 (312-317 cm).

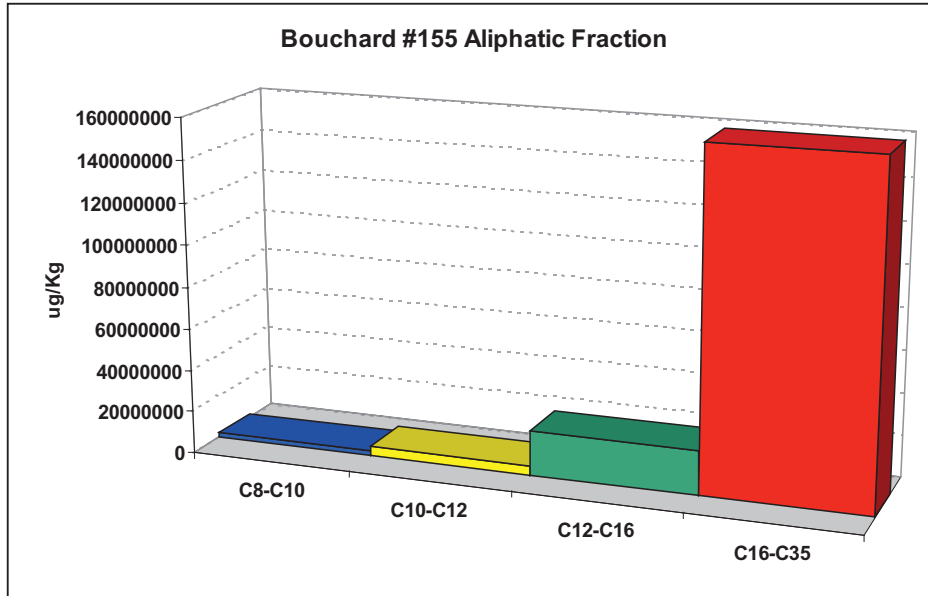

Figure 9: Bouchard 155 reference sample aliphatic concentration.

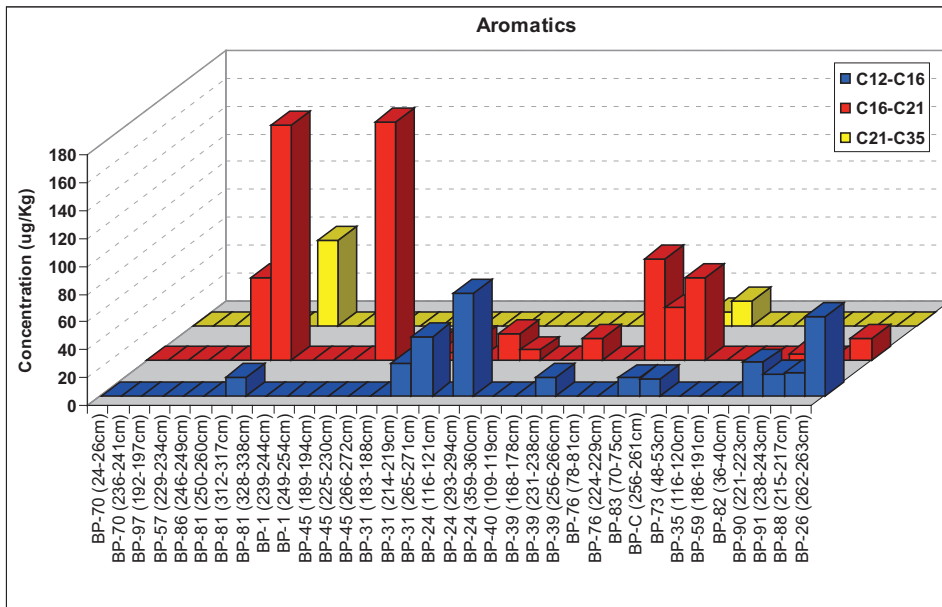

Figure 10: Aromatic fractions for samples with petroleum hydrocarbon levels above detection.

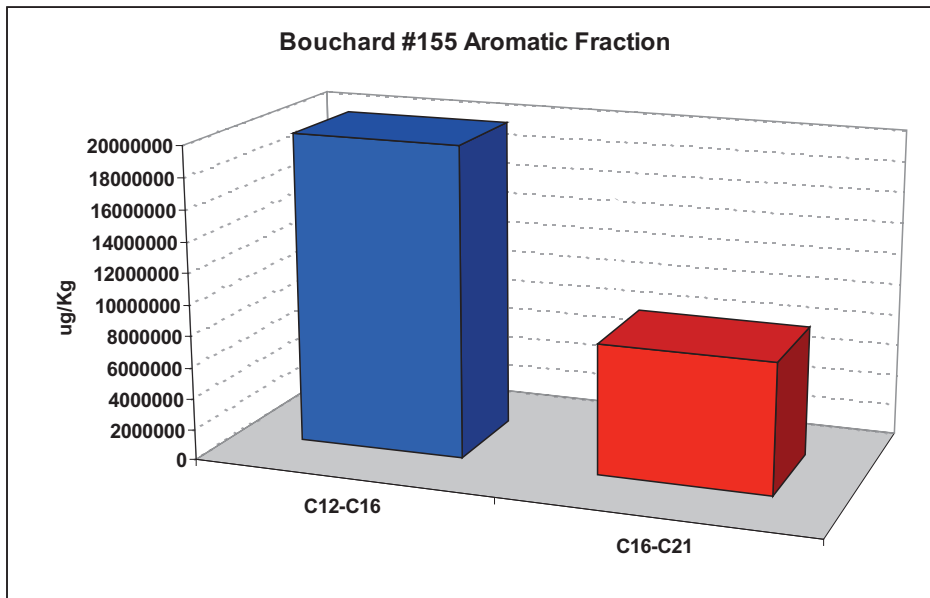

Figure 11: Aromatic fractions in the Bouchard 155 reference sample.

5.3 Reference Sample Petroleum Hydrocarbon Speciation

An oil sample collected just after the oil spill in 1993 from the *Bouchard 155's* tank 7 was analyzed by GC/MS to characterize the speciation of petroleum hydrocarbons. The *Bouchard 155* sample contained a significant amount of volatile petroleum hydrocarbons, mainly species of naphthalene (Figure 12). The speciation of the non-volatile petroleum hydrocarbons of the same sample are shown in Figure 13. The non-volatile species were more representative of the petroleum hydrocarbon species found in most of the Blind Pass sediment cores, but were present in the Pass at much lower concentrations.

5.4 Field Sample Petroleum Hydrocarbon Speciation

North Channel, Mid Channel, Shoal, South Channel, and Outside Pass individual petroleum hydrocarbon speciation data are shown in Figures 14-18. Although sediment cores BP-57, BP-86, BP-1, BP-40, BP-73, and BP-35 exhibited total petroleum hydrocarbon concentrations above total detection limits, no speciation was possible due to individual hydrocarbon species being below detection. In a few samples collected at the beginning of the project, speciation was not conducted. Appendix A includes a photograph of each sediment core interval sampled, a C₈-C₄₀ table, a chromatogram image, and a speciation table for each sample that had total petroleum hydrocarbon concentrations above detection limits. The photographs illustrate that there was usually no visual evidence of elevated petroleum hydrocarbons.

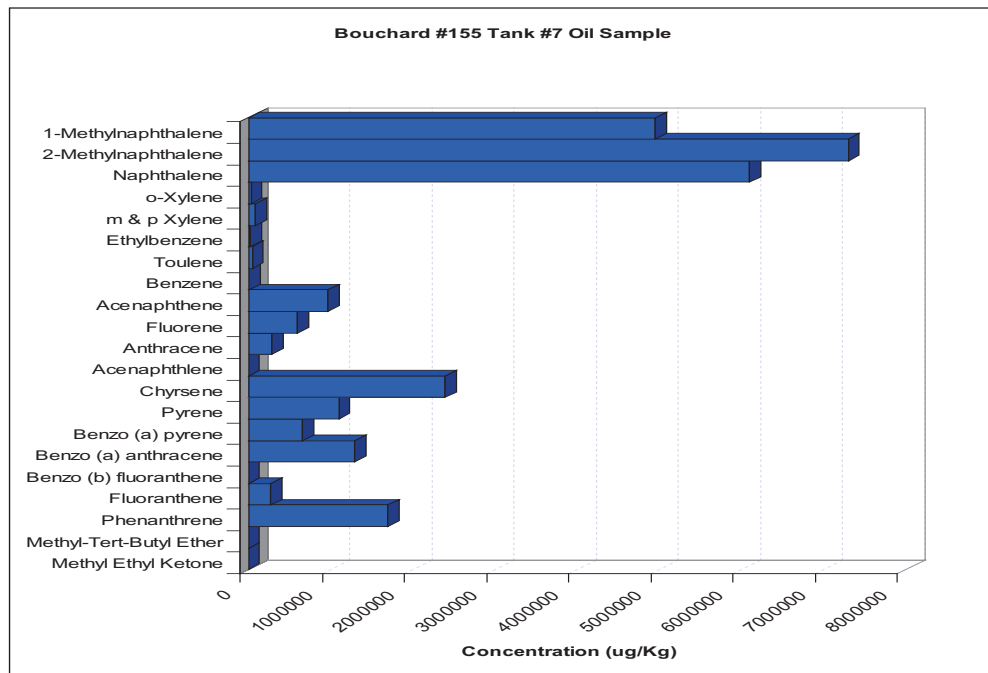

Figure 12: *Bouchard 155* reference sample concentration of all petroleum hydrocarbons.

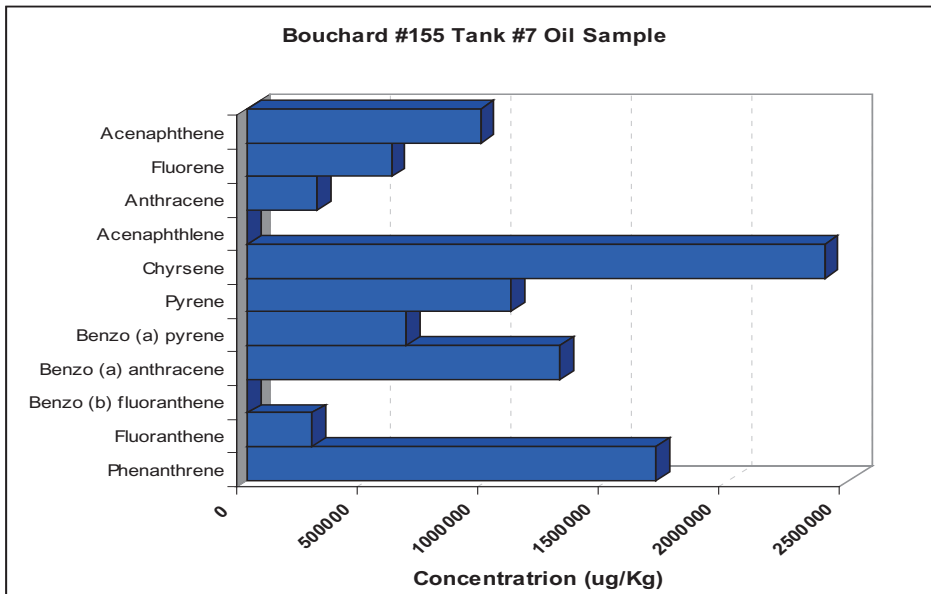

Figure 13: Non-volatile petroleum hydrocarbons in the *Bouchard 155* reference sample.

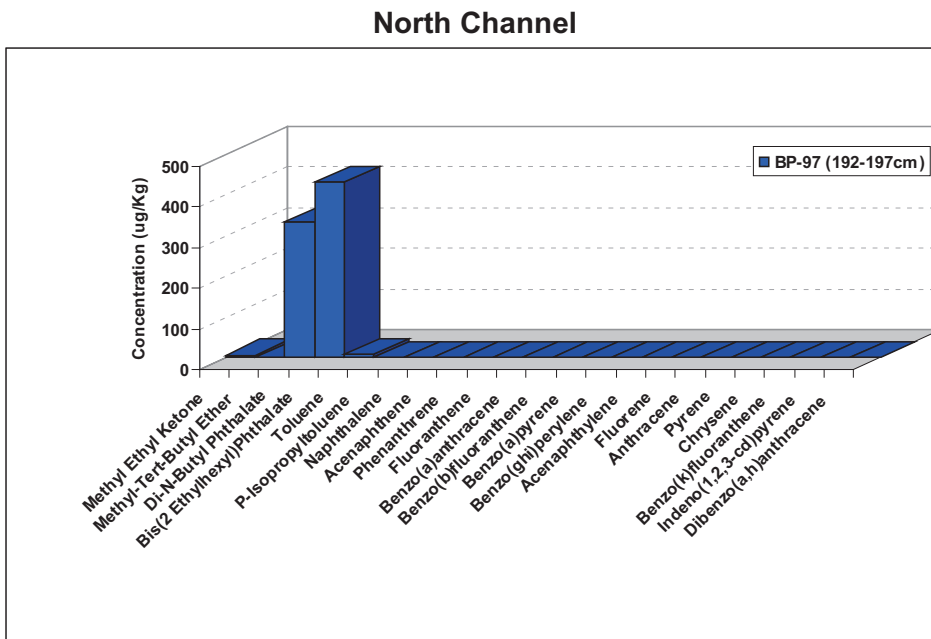

Figure 14: Sample BP-97 (192-197 cm) from the North Channel of Blind Pass contained phthalates and low concentrations of ketones and toluene.

It is noteworthy that in several cores the speciation patterns were distinct from the reference sample, and likely non-spill sources were evident. For example, a sediment sample from the North Channel, core BP-97 (192-197 cm), which exhibited total petroleum hydrocarbon concentrations above detection limits (Figure 14), revealed an unusual speciation pattern. The speciation revealed that this sample contained mostly phthalates (300-400 $\mu\text{g/Kg}$), as well as low concentrations of ketones (5.5 $\mu\text{g/Kg}$) and toluene (7.8 $\mu\text{g/Kg}$).

The Mid Channel area of Blind Pass contained five sediment cores that exhibited total petroleum hydrocarbon concentrations above detection limits. Sediment cores BP-59, BP-70, and BP-76 contained levels of individual petroleum hydrocarbons high enough to permit speciation study. As in the North Channel core BP-97, sediment core BP-59 (186-191 cm) contained ketones (4.4 $\mu\text{g/Kg}$) and phthalates (2.1 $\mu\text{g/Kg}$) (Figure 15A). Two intervals (24-26 cm and 236-241 cm) in core BP-70 exhibited total petroleum hydrocarbons above detection limits, but only one (24-26 cm) had individual petroleum hydrocarbon species above detection limits. This interval contained mostly phthalates (433 $\mu\text{g/Kg}$) and ketones (20.0 $\mu\text{g/Kg}$); two toluene species accounted for 8.1 and 8.7 $\mu\text{g/Kg}$ respectively (Figure 15B).

Two intervals in sediment core BP-76 (78-81 cm and 224-229 cm) exhibited total petroleum hydrocarbons above detection limits. Interval 78-81 cm contained 1.8 $\mu\text{g/Kg}$ of methyl-tert-butyl-ether, while the deeper interval, 224-229 cm, contained petroleum hydrocarbon species similar to the *Bouchard 155* reference sample (Figure 15C). These species include fluoranthene (4.7 $\mu\text{g/Kg}$), benzo(a)anthracene (7.3 $\mu\text{g/Kg}$), benzo(b)fluoranthene (13.2 $\mu\text{g/Kg}$), benzo(a)pyrene (14.0 $\mu\text{g/Kg}$), pyrene (8.4 $\mu\text{g/Kg}$), and chrysene (4.7 $\mu\text{g/Kg}$).

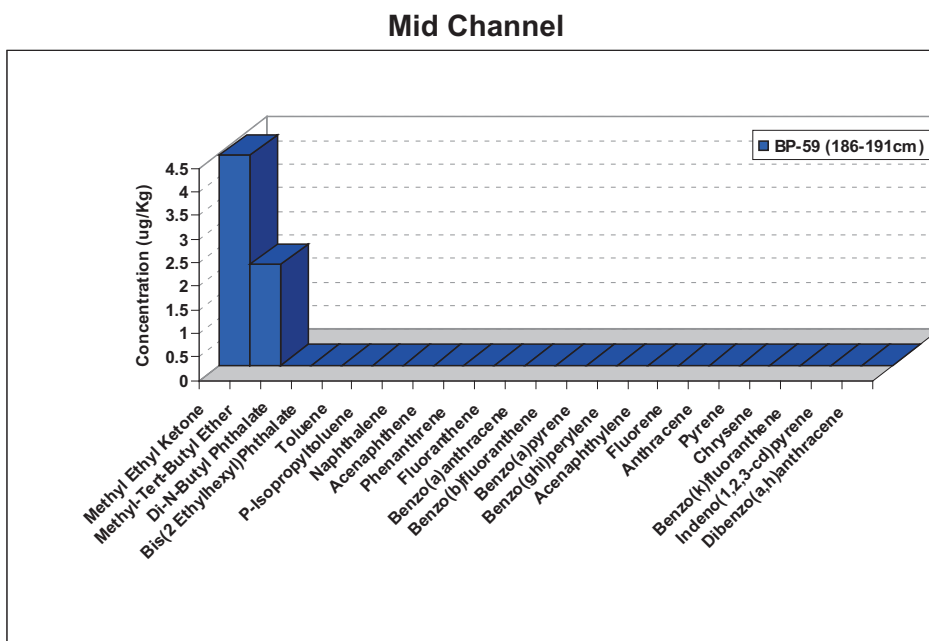

Figure 15A: Blind Pass Mid Channel speciation data indicating concentrations of ether and ketone in BP-59 (186-191 cm).

Mid Channel

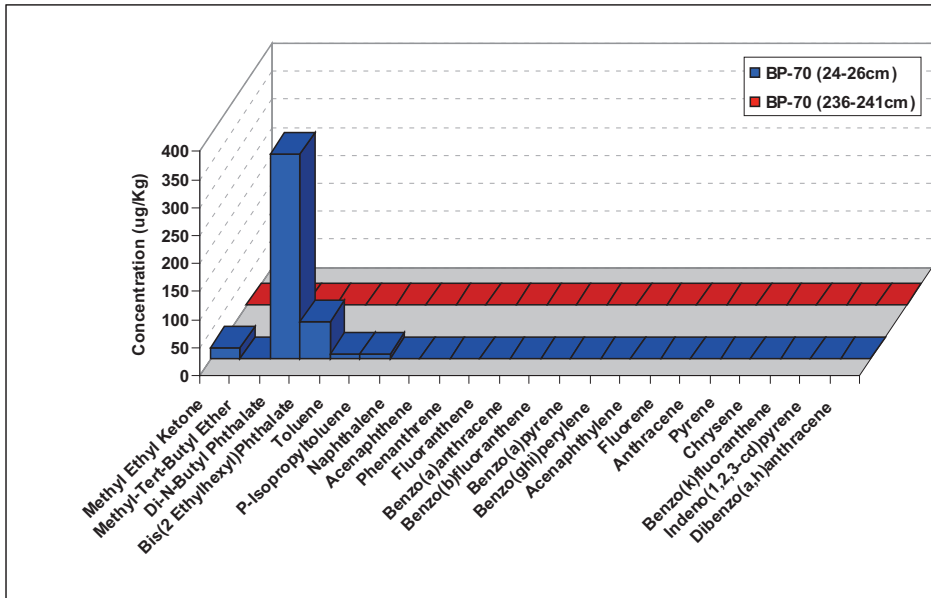

Figure 15B: Evidence of phthalates and low concentrations of ketones and toluene in BP-70

In the South Channel, five sediment cores exhibited total petroleum hydrocarbons above detection limits. Cores BP-39, BP-81, BP-82, and BP-83 exhibited speciation patterns that had a more complex and heavier petroleum hydrocarbon pattern which was similar, although significantly degraded, to the *Bouchard 155* reference sample. No speciation data were available for core BP-1, although two sediment intervals (239-244 cm and 249-254 cm) contained above-detection levels of petroleum hydrocarbons. Sediment core BP-39 contained three sediment intervals (168-178 cm, 231-238 cm, and 256-266 cm) which exhibited concentrations of petroleum hydrocarbons above detection, but only one sediment interval, 231-238 cm, could be analyzed for speciation. The 231-238 cm sediment interval contained 1.9 $\mu\text{g}/\text{Kg}$ of methyl-tert-butyl-ether, 2.5 $\mu\text{g}/\text{Kg}$ of fluoranthene, 5.7 $\mu\text{g}/\text{Kg}$ of benzo(a)anthracene, 2.6 $\mu\text{g}/\text{Kg}$ of benzo(b)fluoranthene, 4.2 $\mu\text{g}/\text{Kg}$ of benzo(a)pyrene, 9.5 $\mu\text{g}/\text{Kg}$ of pyrene, and 3.4 $\mu\text{g}/\text{Kg}$ of chrysene (Figure 16A).

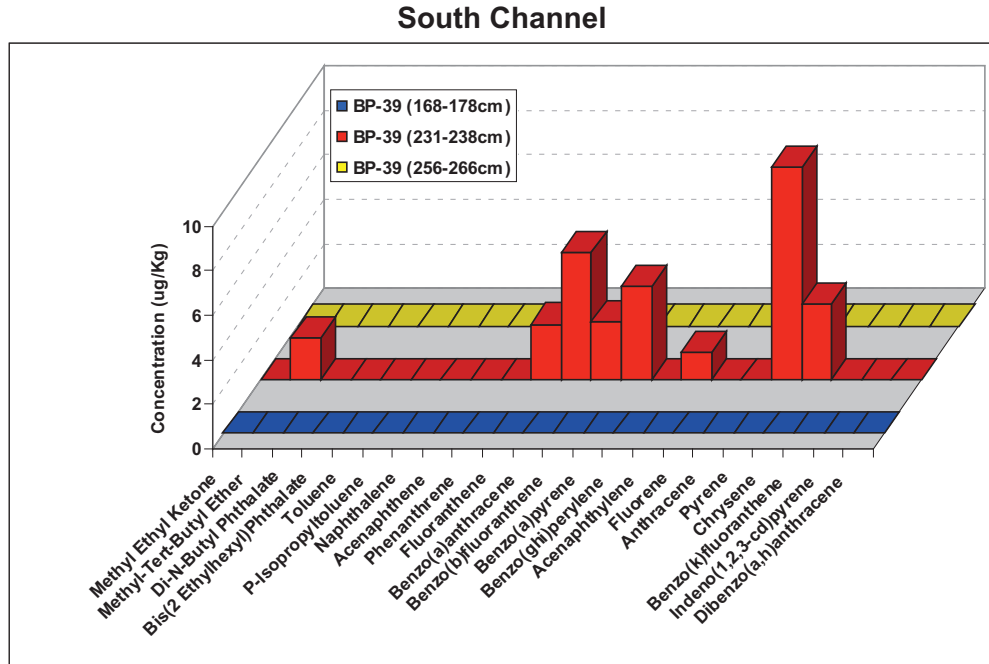

Figure 16A: Individual petroleum hydrocarbon speciation of BP-39 (168-178 cm, 231-238 cm, and 256-266 cm) from the South Channel of Blind Pass.

Sediment core BP-81 also exhibited three above detection sediment intervals (250-260 cm, 312-317 cm, and 328-338 cm), with above detection total petroleum hydrocarbons. Sediment interval 250-260 cm contained 5.7 µg/Kg of benzo(a)anthracene, 15.5 µg/Kg of benzo(b)fluoranthene, 14.9 µg/Kg of benzo(a)pyrene, 16.0 µg/Kg of pyrene, 7.4 µg/Kg of chrysene, and 1.9 µg/Kg of dibenzo(a,h)anthracene. Sediment interval 312-317 cm contained 7.2 µg/Kg of benzo(a)anthracene, 50.0 µg/Kg of benzo(b)fluoranthene, 64.7 µg/Kg of benzo(a)pyrene, 25.0 µg/Kg of benzo(ghi)perylene, 3.2 µg/Kg acenaphthylene, 23.0 µg/Kg of pyrene, 13.9 µg/Kg of chrysene, 7.1 µg/Kg of benzo(k)fluoranthene, 20.1 µg/Kg of indeno(1,2,3-cd)pyrene, and 16.5 µg/Kg of dibenzo(a,h)anthracene. The last and deepest sediment interval, 328-338 cm, contained only two petroleum hydrocarbon species, 1.5 µg/Kg of benzo(b)fluoranthene and 1.7 µg/Kg of benzo(a)pyrene (Figure 16B).

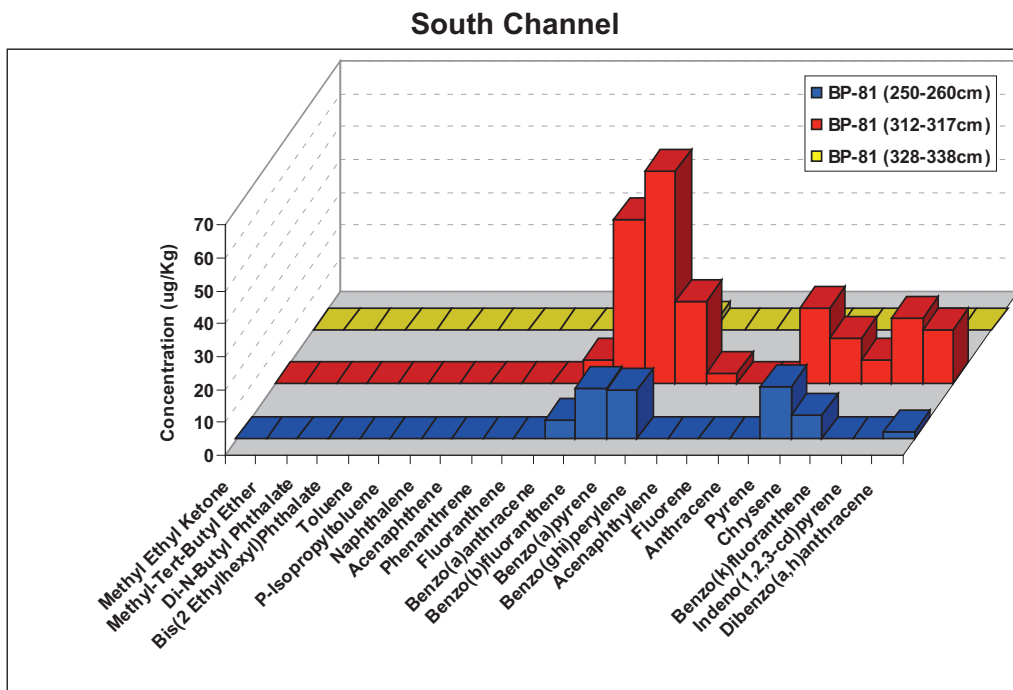

Figure 16B: Individual petroleum hydrocarbon speciation of BP-81 (250-260 cm, 312-317 cm, and 328-338 cm) from the South Channel of Blind Pass.

Sediment core BP-82 had one interval, 36-40 cm, which contained 2.6 µg/Kg methyl-tert-butyl-ether (Figure 16C). Sediment core BP-83 (70-75 cm) contained one sediment interval that exhibited total petroleum hydrocarbon concentrations above detection limits. Sediment interval 70-75 cm contained 1.4 µg/Kg of methyl ethyl ketone, 4.5 µg/Kg of methyl-tert-butyl-ether, 10.6 µg/Kg of naphthalene, 4.1 µg/Kg of benzo(a)anthracene, 7.8 µg/Kg of benzo(b)fluoranthene, 5.3 µg/Kg of benzo(a)pyrene, 2.0 µg/Kg of benzo(ghi)perylene, 2.8 µg/Kg of pyrene, 9.2 µg/Kg of chrysene, 5.5 µg/Kg of benzo(k)fluoranthene, and 7.9 µg/Kg of indeno(1,2,3-cd)pyrene (Figure 16D).

The Shoal area of Blind Pass had a total of six sediment cores which exhibited total petroleum hydrocarbon concentrations above detection limits. No speciation data are available for core BP-40, although one sediment interval, 109-119 cm, contained above-detection levels of petroleum hydrocarbons.

Sediment core BP-24 had three sediment intervals (116-121 cm, 293-294 cm, and 359-360 cm) which exhibited petroleum hydrocarbons above detection limits. Sediment interval 116-121 cm had levels too low to determine species of individual petroleum hydrocarbons. Sediment interval 293-294 cm contained 2.9 µg/Kg of methyl ethyl ketone, 2.4 µg/Kg of methyl-tert-butyl-ether, 1.8 µg/Kg of acenaphthene, 11.1 µg/Kg of phenanthrene, 28.0 µg/Kg of fluoranthene, 8.3 µg/Kg of benzo(a)anthracene, 2.9 µg/Kg of benzo(b)fluoranthene, 2.7 µg/Kg of benzo(a)pyrene, 1.6 µg/Kg of fluorene, 2.6 µg/Kg of anthracene, 28.5 µg/Kg of pyrene, and 4.9 µg/Kg of chrysene. Sediment interval 359-360 cm contained 9.0 µg/Kg of methyl ethyl ketone, 2.3 µg/Kg of methyl-tert-butyl-ether, 3.4 µg/Kg of fluoranthene, 1.4 µg/Kg of benzo(a)anthracene, and 2.8 µg/Kg of pyrene (Figure 17A).

Sediment core BP-26 had one sediment interval, 262-263 cm, which exhibited petroleum hydrocarbon levels above detection. Sediment interval 262-263 cm contained 1.6 µg/Kg of methyl-tert-butyl-ether, 8.8 µg/Kg of phenanthrene, 25.0 µg/Kg of fluoranthene, 6.1 µg/Kg of benzo(a)anthracene, 2.2 µg/Kg of benzo(b)fluoranthene, 1.9 µg/Kg of benzo(a)pyrene, 1.2 µg/Kg of acenaphthylene, 2.2 µg/Kg of anthracene, 19.5 µg/Kg of pyrene, and 5.4 µg/Kg of chrysene (Figure 17B).

Sediment core BP-31 had three sediment intervals (183-188 cm, 214-219 cm, and 265-271 cm) which exhibited petroleum hydrocarbons levels above detection. Sediment interval 183-188 cm contained 4.2 µg/Kg of fluoranthene, 2.0 µg/Kg of benzo(a)anthracene, 2.2 µg/Kg of benzo(b)fluoranthene, 1.4 µg/Kg of benzo(a)pyrene, 3.0 µg/Kg of pyrene, and 1.4 µg/Kg of chrysene. Sediment interval 214-219 cm contained 3.1 µg/Kg of methyl ethyl ketone, 2.2 µg/Kg of methyl-tert-butyl-ether, 3.0 µg/Kg of phenanthrene, 11.4 µg/Kg of fluoranthene, 2.3 µg/Kg of benzo(a)anthracene, 1.3 µg/Kg of benzo(b)fluoranthene, 8.2 µg/Kg of pyrene, and 1.8 µg/Kg of chrysene. Sediment interval 265-271 cm contained 3.5 µg/Kg of methyl ethyl ketone, 2.2 µg/Kg of methyl-tert-butyl-ether, 4.1 µg/Kg of phenanthrene, 20.1 µg/Kg of fluoranthene, 6.9 µg/Kg of benzo(a)anthracene, 2.4 µg/Kg of benzo(b)fluoranthene, 2.0 µg/Kg of benzo(a)pyrene, 1.1 µg/Kg of anthracene, 16.5 µg/Kg of pyrene, and 4.1 µg/Kg of chrysene (Figure 17C).

South Channel

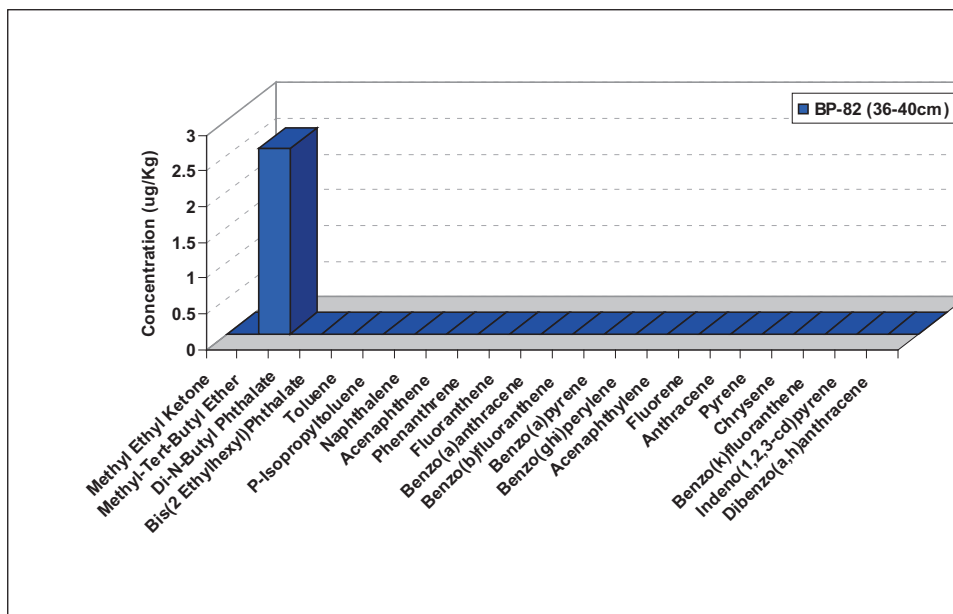

Figure 16C: Ether was the major component in a near surface sample in BP-82 (36-40 cm) from a South Channel core in Blind Pass.

South Channel

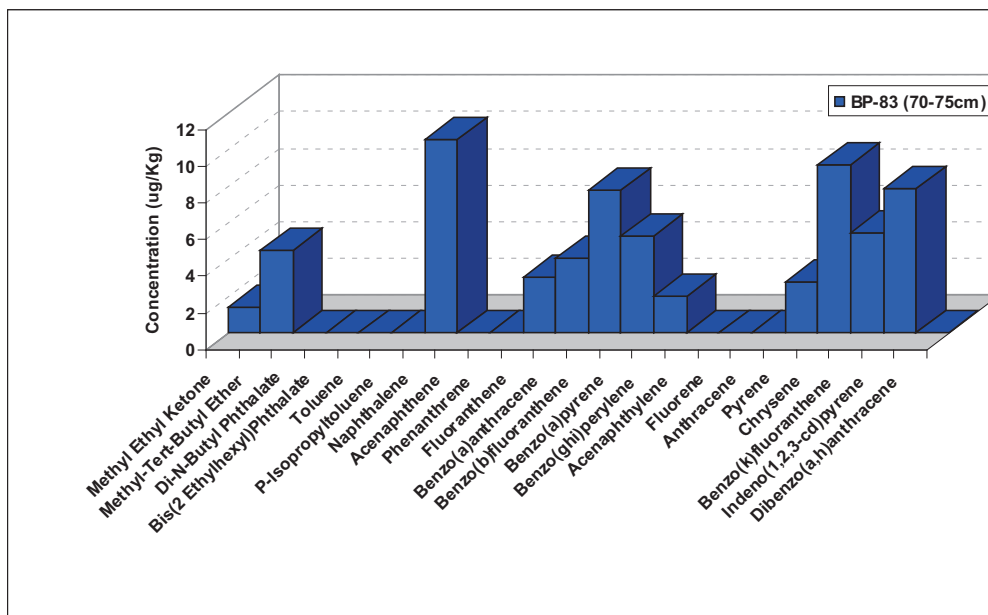

Figure 16D: Individual petroleum hydrocarbon speciation of BP-83 (70-75 cm) from the South Channel of Blind Pass.

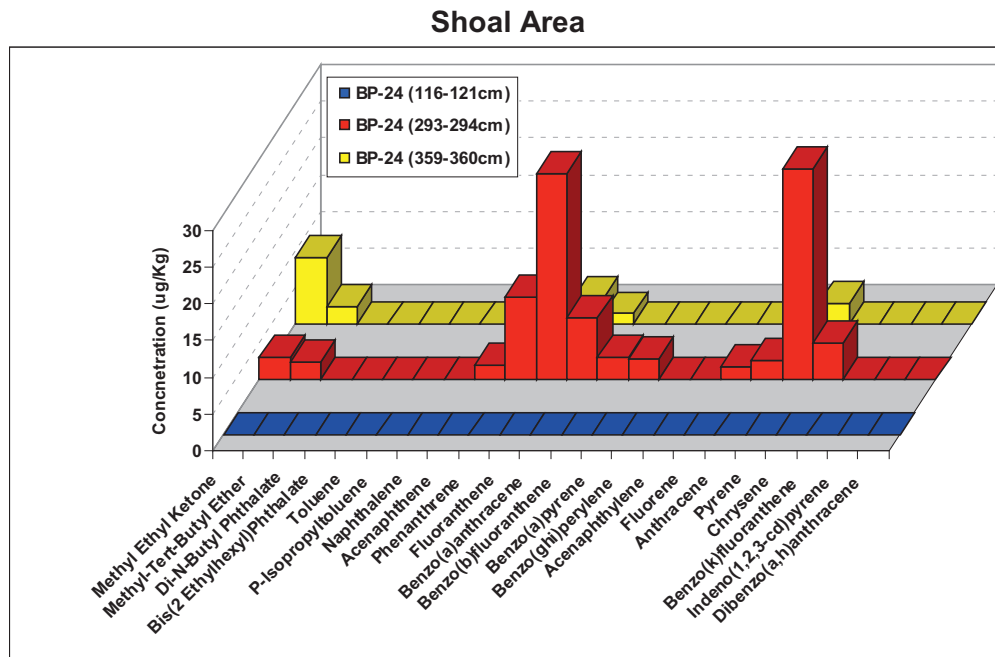

Figure 17A: Individual petroleum hydrocarbon speciation of BP-24 (116-121 cm, 293-294 cm, and 359-360 cm) from the Shoal area of Blind Pass.

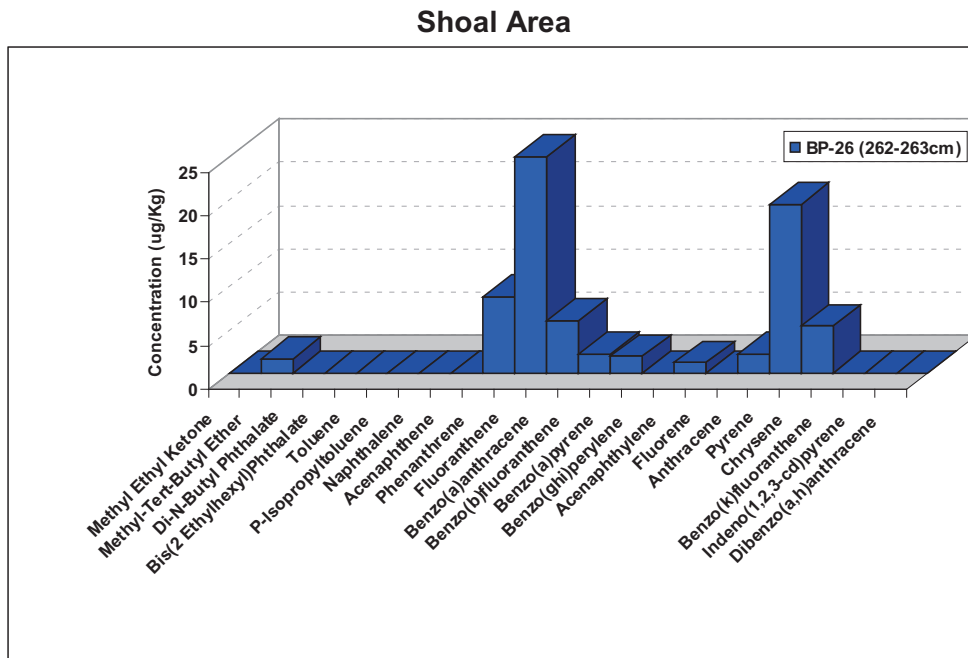

Figure 17B: Individual petroleum hydrocarbon speciation of BP-26 (262-263 cm) from the Shoal area of Blind Pass.

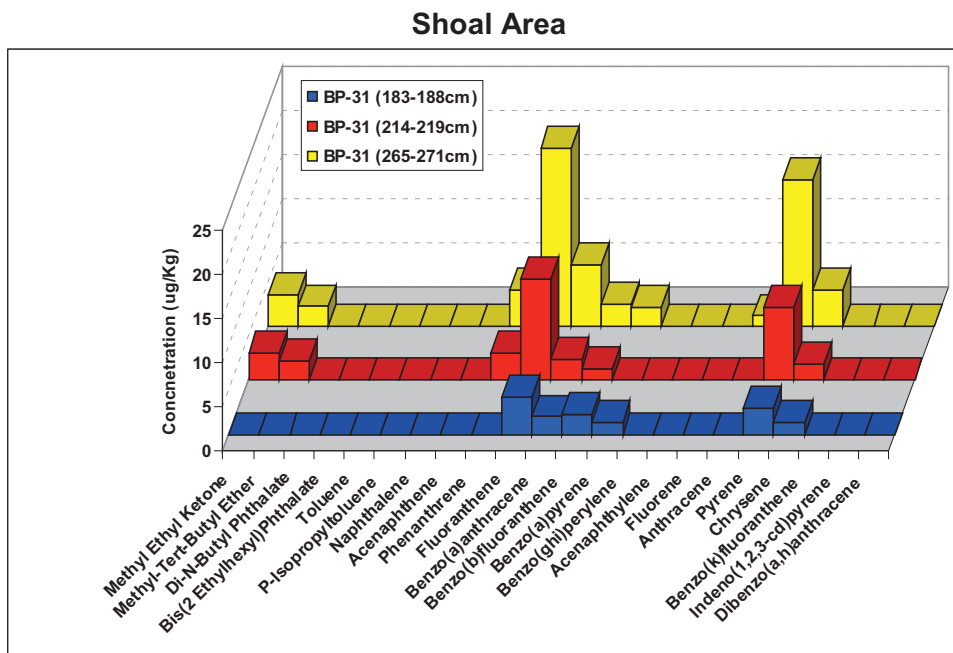

Figure 17C: Individual petroleum hydrocarbon speciation of BP-31 (183-188 cm, 214-219 cm, and 265-271 cm) from the Shoal area of Blind Pass.

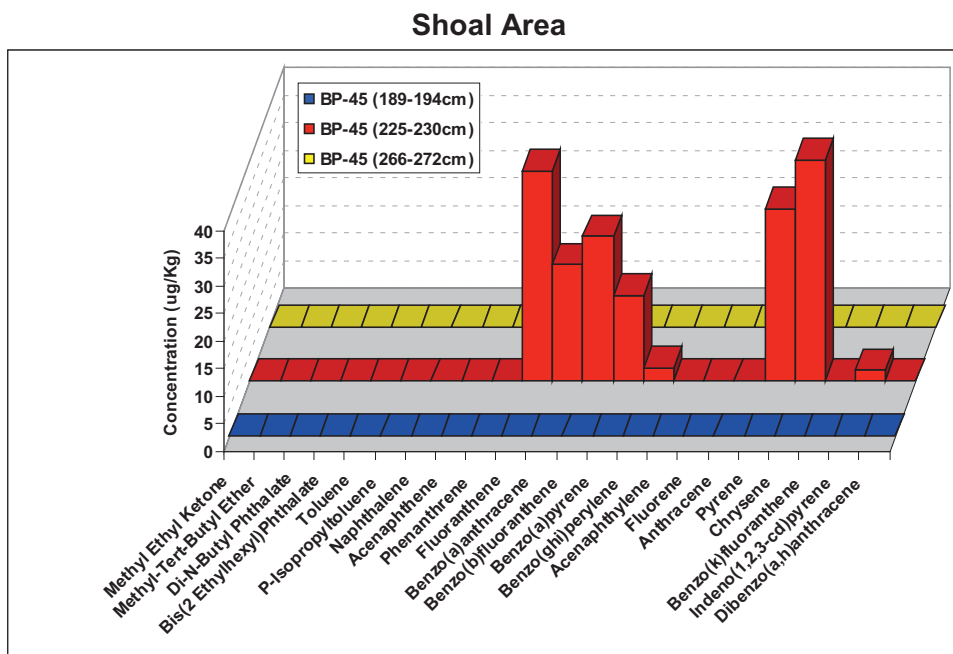

Figure 17D: Individual petroleum hydrocarbon speciation of BP-45 (189-194 cm, 225-230 cm, and 266-272 cm) from the Shoal area of Blind Pass.

Sediment core BP-45 had three sediment intervals (189-191 cm, 225-230 cm, and 266-272 cm) which exhibited petroleum hydrocarbon levels above detection. Petroleum hydrocarbon speciation could only be determined in sediment interval 225-230 cm. This interval contained 37.9 µg/Kg of fluoranthene, 21.0 µg/Kg of benzo(a)anthracene, 26.1 µg/Kg of benzo(b)fluoranthene, 15.4 µg/Kg of benzo(a)pyrene, 2.4 µg/Kg of benzo(ghi)perylene, 31.0 µg/Kg of pyrene, 40.0 µg/Kg of chrysene, and 1.9 µg/Kg of indeno(1,2,3-cd)pyrene (Figure 17D).

Sediment core BP-91 had only one sediment interval, 238-243 cm, which exhibited petroleum hydrocarbon levels above detection. It contained 2.3 µg/Kg of methyl-tert-butyl-ether, 5.1 µg/Kg of phenanthrene, 6.1 µg/Kg of fluoranthene, 1.5 µg/Kg of benzo(a)anthracene, 1.1 µg/Kg of benzo(b)fluoranthene, and 4.2 µg/Kg of pyrene (Figure 17E). Most of the petroleum hydrocarbons detected in the Shoal area sediment cores were similar in composition to the *Bouchard 155* reference sample.

The Outside area of Blind Pass had a total of five sediment cores (BP-C, BP-57, BP-88, BP-86, and BP-90) which exhibited total petroleum hydrocarbon concentrations above detection limits. Sediment cores BP-57 and BP-86 had no speciation data because of the individual petroleum hydrocarbons being below detection.

Sediment core BP-C had one sediment interval, 256-261 cm, which exhibited petroleum hydrocarbons above detection. The petroleum hydrocarbons were comprised of 1.9 µg/Kg of methyl ethyl ketone, 1.7 µg/Kg of methyl-tert-butyl-ether, 2.5 µg/Kg of phenanthrene, 12.5 µg/Kg of fluoranthene, 1.8 µg/Kg of benzo(a)anthracene, 11.3 µg/Kg of benzo(b)fluoranthene, 8.7 µg/Kg of benzo(a)pyrene, 6.0 µg/Kg of benzo(ghi)perylene, 10.9 µg/Kg of pyrene, 7.9 µg/Kg of chrysene, 5.8 µg/Kg of benzo(k)fluoranthene, and 11.5 µg/Kg of indeno(1,2,3-cd)pyrene (Figure 18A).

Sediment core BP-88 had one sediment interval, 215-217 cm, which exhibited levels of petroleum hydrocarbons above detection. This interval contained 2.2 µg/Kg of methyl-tert-butyl-ether, 3.3 µg/Kg of phenanthrene, 6.6 µg/Kg of fluoranthene, 1.2 µg/Kg benzo(b)fluoranthene, 1.5 µg/Kg of benzo(a)pyrene, and 5.9 µg/Kg of pyrene (Figure 18B).

Sediment core BP-90 had one sediment interval, 221-223 cm, which exhibited levels of petroleum hydrocarbons above detection. This interval was comprised of 6.6 µg/Kg of methyl ethyl ketone, 3.2 µg/Kg of methyl-tert-butyl-ether, 3.1 µg/Kg of phenanthrene, 11.9 µg/Kg of fluoranthene, 2.3 µg/Kg of benzo(a)anthracene, 1.7 µg/Kg of benzo(b)fluoranthene, 1.1 µg/Kg of benzo(a)pyrene, and 8.5 µg/Kg of pyrene (Figure 18C). Most of the petroleum hydrocarbon species detected in the sediment cores from the Outside Pass area were similar to those detected in the *Bouchard 155* reference sample.

Shoal Area

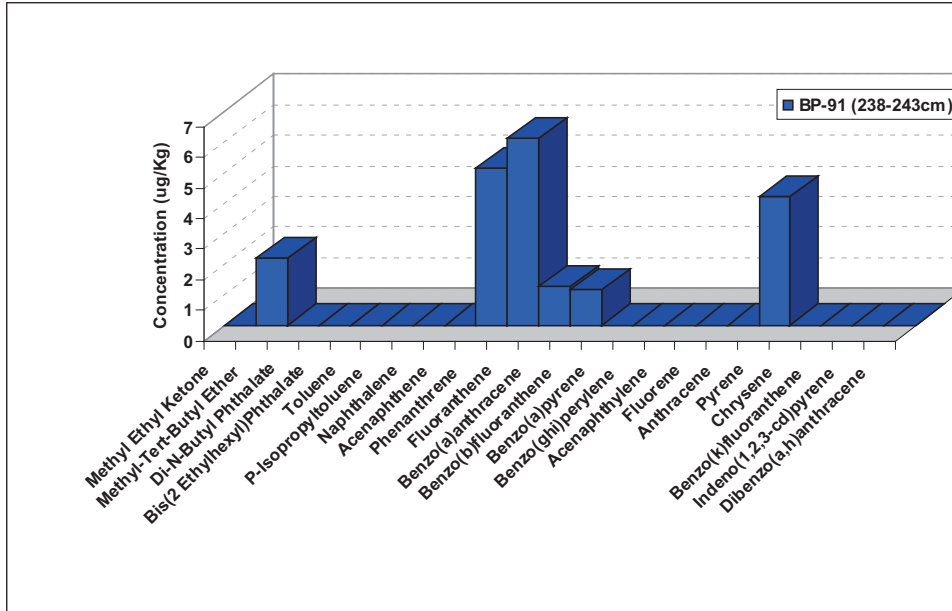

Figure 17E: Individual petroleum hydrocarbon speciation of BP-91 (238-243 cm) from the Shoal area of Blind Pass.

Outside Pass

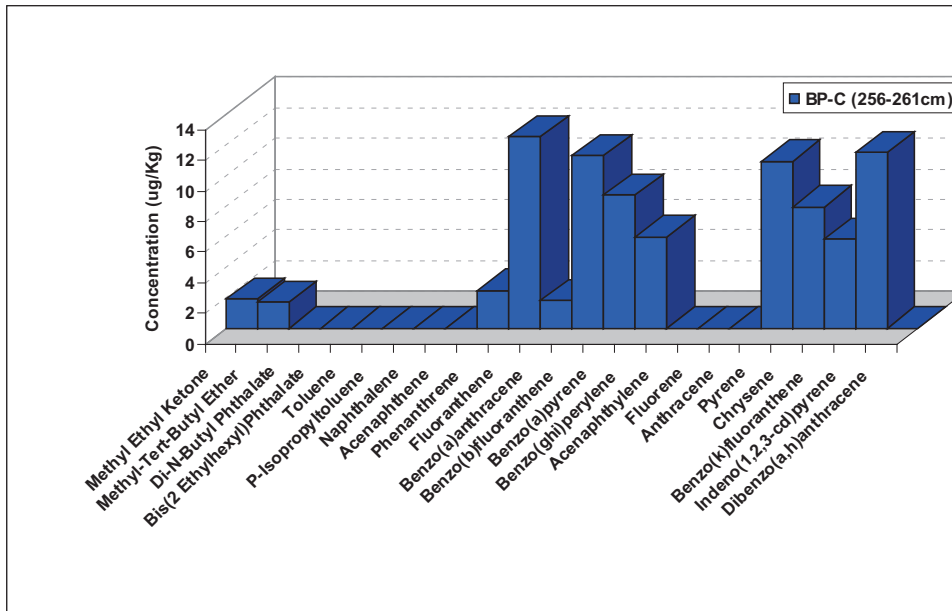

Figure 18A: Individual petroleum hydrocarbon speciation of BP-C (256-261 cm) from the Outside area of Blind Pass.

Outside Pass

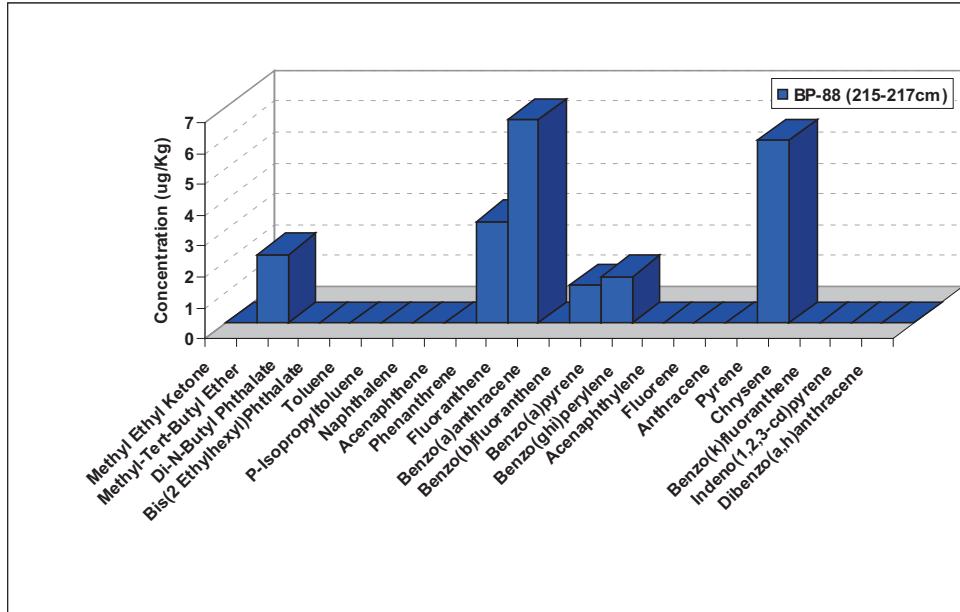

Figure 18B: Individual petroleum hydrocarbon speciation of BP-88 (215-217 cm) from the Outside area of Blind Pass.

Outside Pass

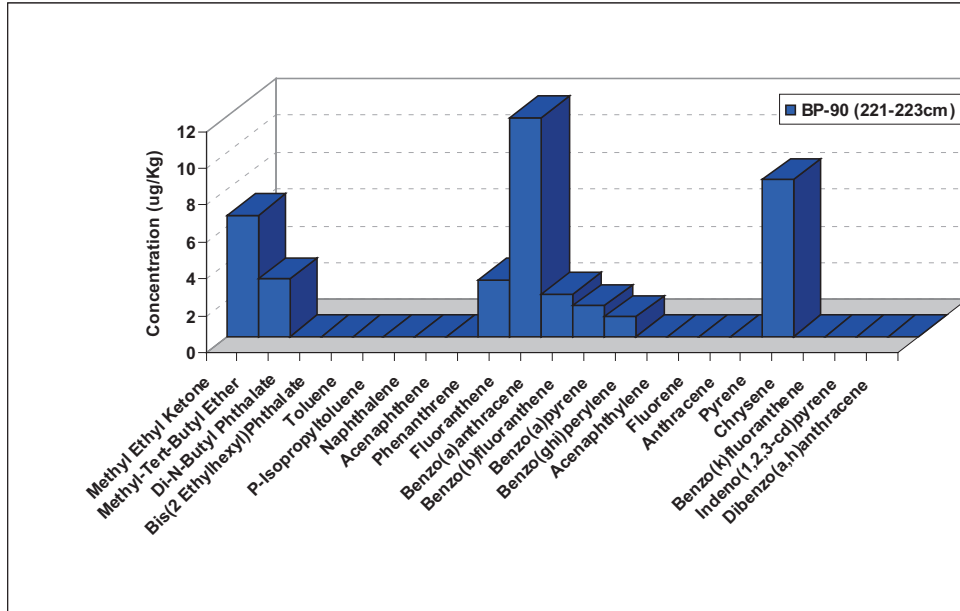

Figure 18C: Individual petroleum hydrocarbon speciation of BP-90 (221-223 cm) from the Outside area of Blind Pass.

5.5 Threshold Effective and Possible Effective Level (TEL and PEL) Results

As an interpretative tool, the FDEP Report *Approach to the Assessment of Sediment Quality in Florida Coastal Waters, Volume 1: Development and Evaluation of Sediment Quality Assessment Guidelines* by MacDonald (1994) was used as a reference to assess contamination levels of individual petroleum hydrocarbons. The levels of individual hydrocarbons were compared to the TEL (threshold effective levels) and PEL (possible effective levels) as discussed in this document, which are based on an extensive literature database. As described in detail below, almost without exception the individual petroleum hydrocarbons were found at concentrations considerably below TEL described in the literature.

5.5.1 High Molecular Weight Hydrocarbons

Concentrations of benzo(a)anthracene (Figure 19) were generally highest in the Shoal area of Blind Pass. The highest value (20 µg/Kg) observed was considerably lower than the TEL value of 74.8 µg/Kg. The highest concentration of benzo(a)pyrene found in the Blind Pass sediment cores (Figure 20) was approximately 20 µg/Kg, which is lower than the TEL value of 88.8 µg/Kg.

Pyrene and chrysene values were highest in the Shoal and South Channel areas of Blind Pass. The highest pyrene value was five times less than the TEL value (Figure 21), and chrysene values were much lower than the TEL (Figure 22). Fluoranthene occurred most frequently in the Outside Pass, Shoal area, and South Channel regions of Blind Pass. The highest concentration (38.0 µg/Kg) was observed in the Shoal area, which was considerably less than the TEL value of 113.0 µg/Kg (Figure 23).

5.5.2 Low Molecular Weight Hydrocarbons

The highest concentration of phenanthrene (11.1 µg/Kg) was eight times less than the TEL (86.7 µg/Kg) in a Shoal area sediment core (Figure 24). Detectable concentrations of acenaphthylene was found in one Shoal area and two South Channel sediment cores in Blind Pass with the highest level (3.2 µg/Kg) being half that of the TEL value (5.9 µg/Kg) (Figure 25). Only one Shoal area sediment core exhibited above-detection levels of fluorene (Figure 26) at concentrations 13 times lower than the TEL. Anthracene in three Shoal area Blind Pass sediment cores were above detection levels (Figure 27) at concentrations 18 times lower than the TEL value. Acenaphthene was found in one Shoal area Blind Pass sediment core at a concentration three times less than the TEL (Figure 28). Phthalates were found in two sediment cores (Figure 29). The highest concentration, 432.0 µg/Kg, was more than double the TEL value (182.0 µg/Kg).

The following histograms describe the individual speciation data compared to published TEL and PEL information. These have been color coded to represent the five different areas sampled in Blind Pass: red = North End Channel; yellow = Mid Channel; blue = South Channel; green = Shoal; and orange = Outside Pass.

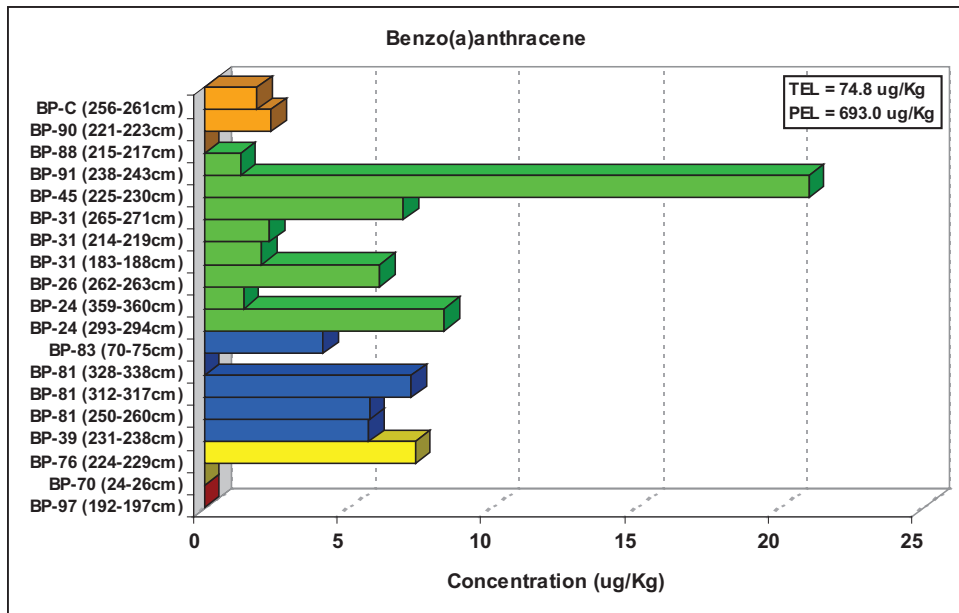

Figure 19: Concentrations of benzo(a)anthracene in Blind Pass cores (TEL = threshold effective level, PEL = possible effective level [MacDonald, 1994], yellow = Mid Channel, blue = South Channel, green = Shoal, and orange = Outside Pass).

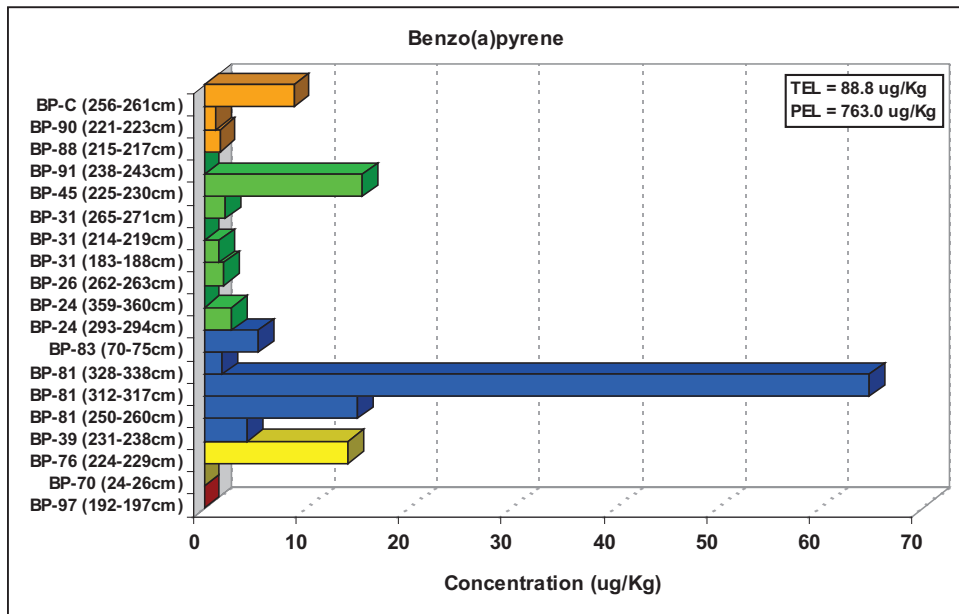

Figure 20: Concentrations of benzo(a)pyrene in Blind Pass cores (TEL = threshold effective level, PEL = possible effective level [MacDonald, 1994], yellow = Mid Channel, blue = South Channel, green = Shoal, and orange = Outside Pass).

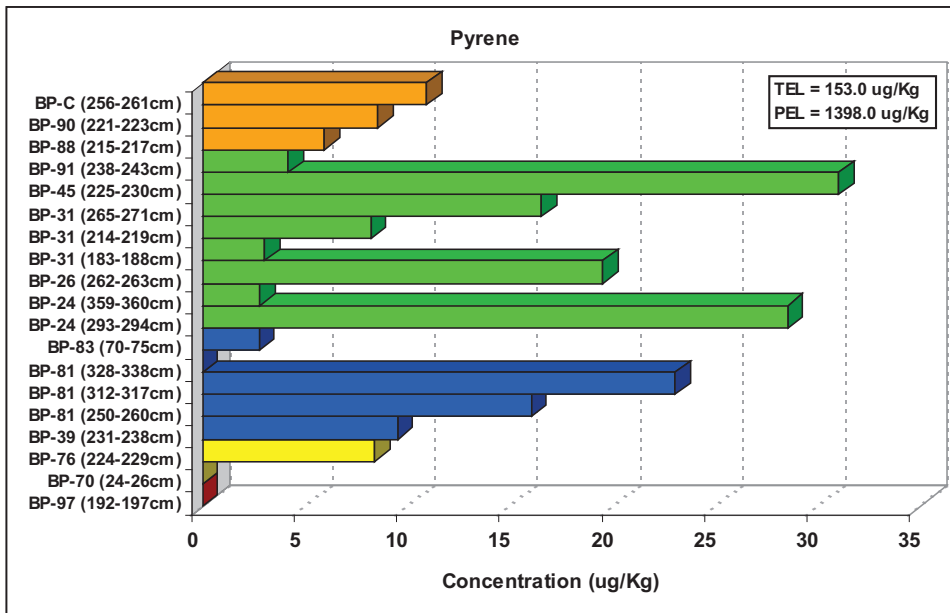

Figure 21: Concentrations of pyrene in Blind Pass cores (TEL = threshold effective level, PEL = possible effective level [MacDonald, 1994], yellow = Mid Channel, blue = South Channel, green = Shoal, and orange = Outside Pass).

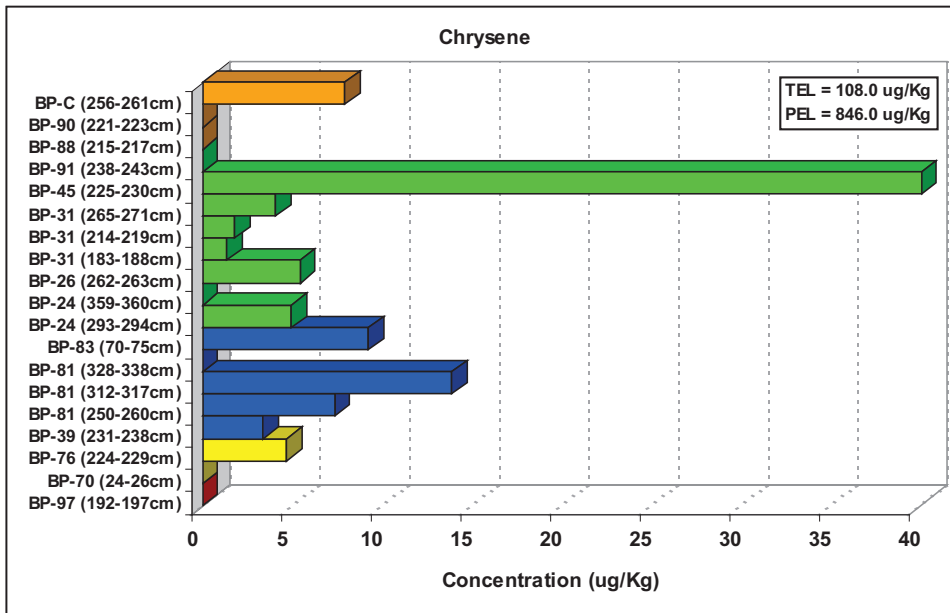

Figure 22: Concentrations of chrysene in Blind Pass cores (TEL = threshold effective level, PEL = possible effective level [MacDonald, 1994], yellow = Mid Channel, blue = South Channel, green = Shoal, and orange = Outside Pass).

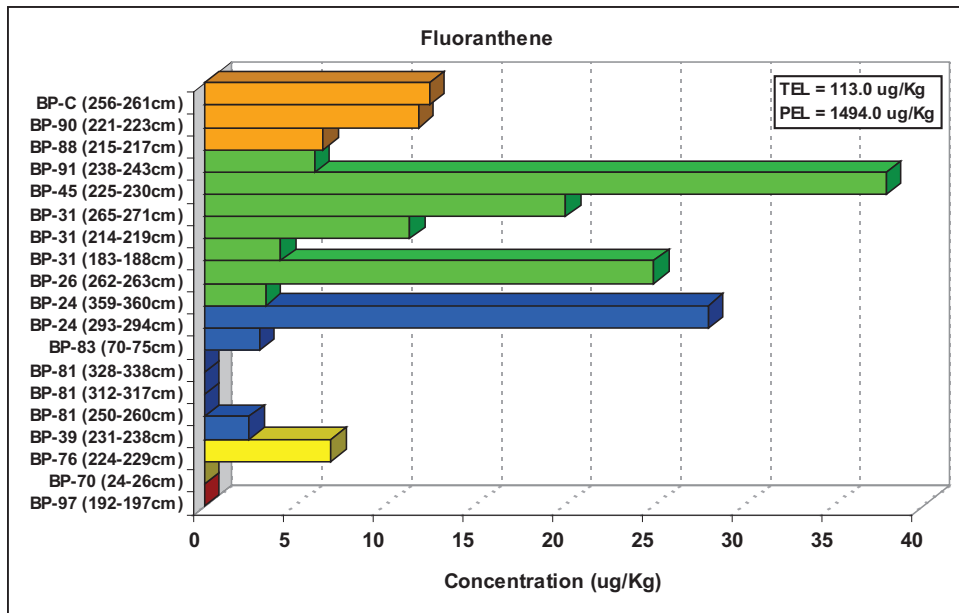

Figure 23: Concentrations of fluoranthene in Blind Pass cores (TEL = threshold effective level, PEL = possible effective level [MacDonald, 1994], yellow = Mid Channel, blue = South Channel, green = Shoal, and orange = Outside Pass).

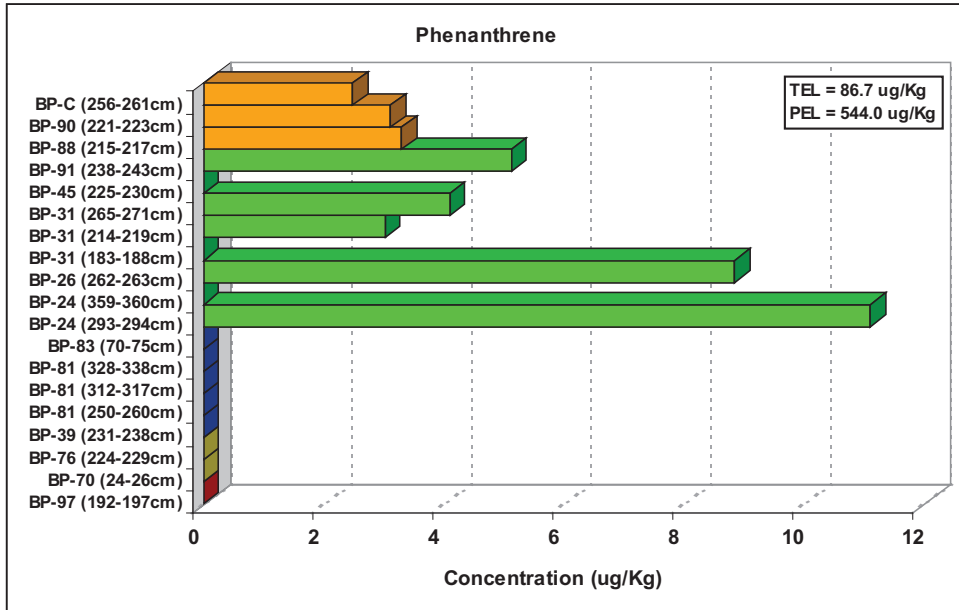

Figure 24: Concentrations of phenanthrene in Blind Pass cores (TEL = threshold effective level, PEL = possible effective level [MacDonald, 1994], green = Shoal, and orange = Outside Pass).

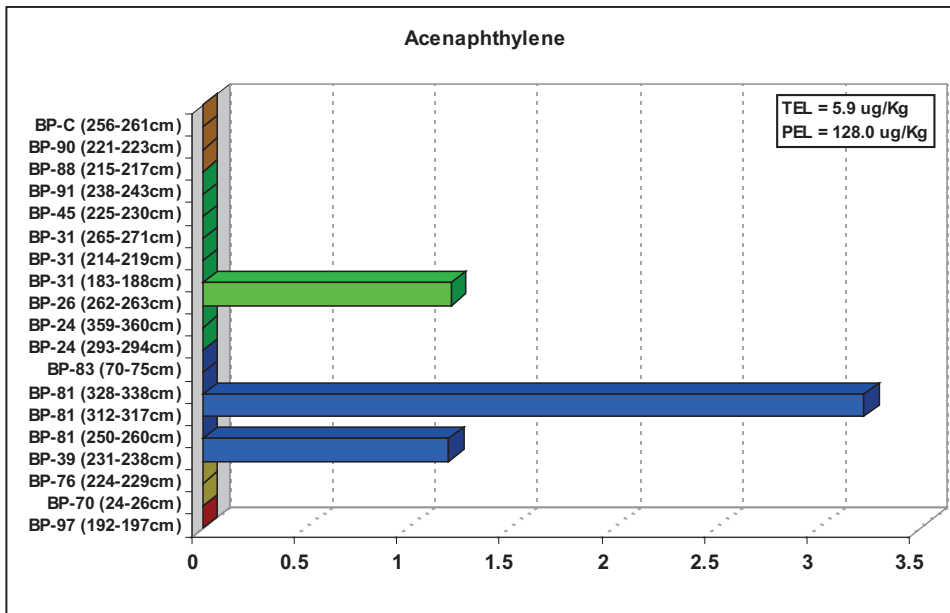

Figure 25: Concentrations of acenaphthylene in Blind Pass cores (TEL = threshold effective level, PEL = possible effective level [MacDonald, 1994], blue = South Channel, and green = Shoal).

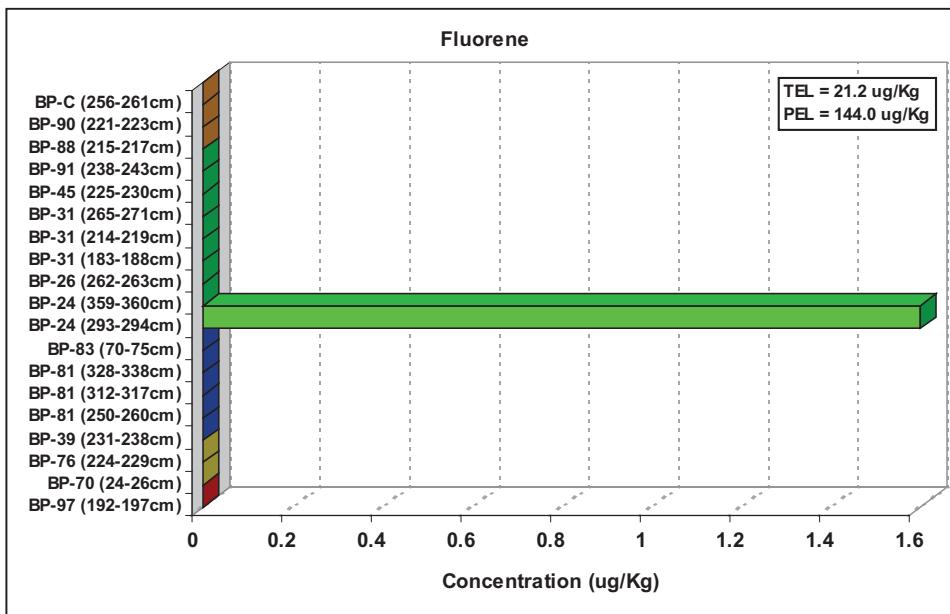

Figure 26: Concentrations of fluorene in Blind Pass cores (TEL = threshold effective level, PEL = possible effective level [MacDonald, 1994], green = Shoal).

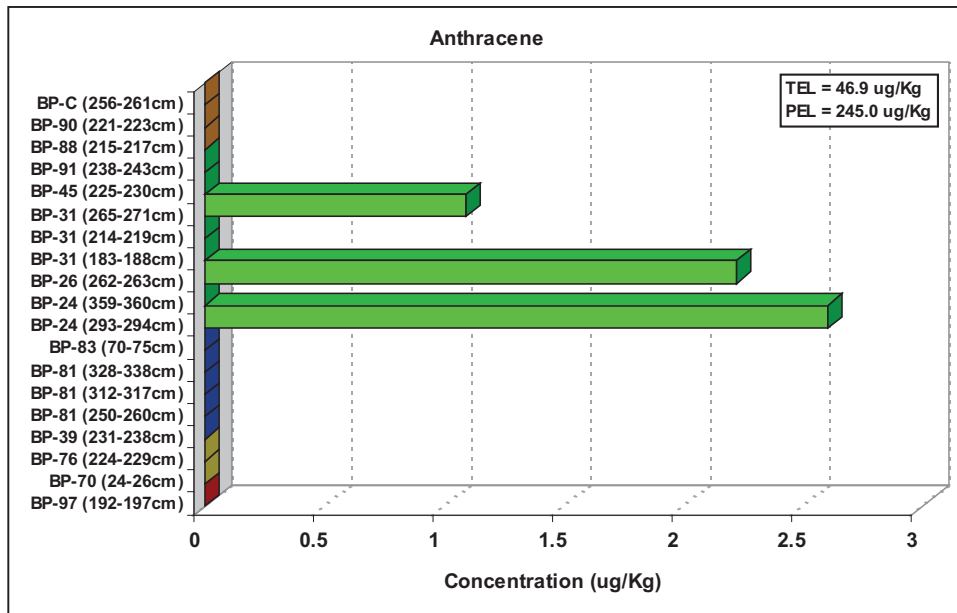

Figure 27: Concentrations of anthracene in Blind Pass cores (TEL = threshold effective level, PEL = possible effective level [MacDonald, 1994], green = Shoal).

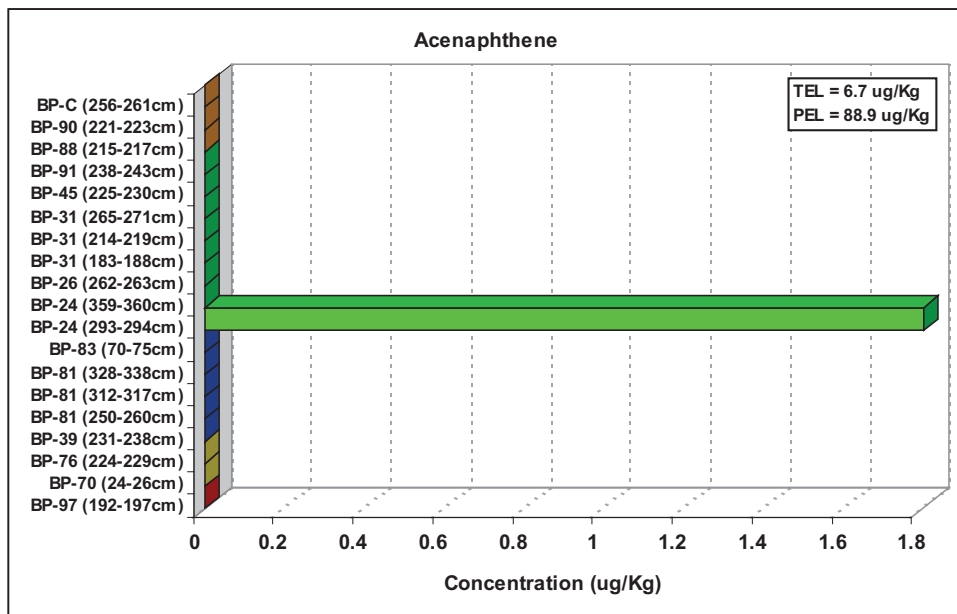

Figure 28: Concentrations of acenaphthene in Blind Pass cores (TEL = threshold effective level, PEL = possible effective level [MacDonald, 1994], green = Shoal).

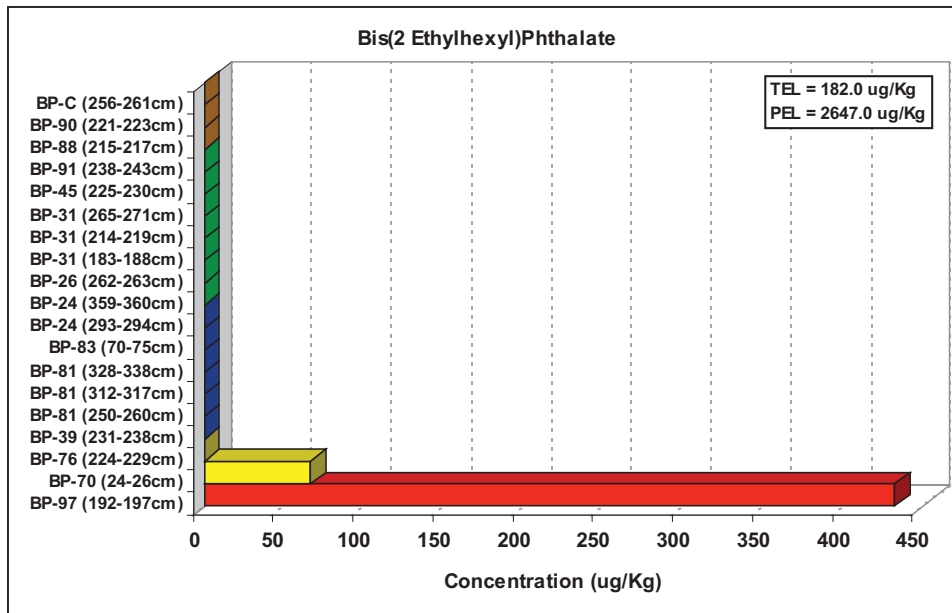

Figure 29: Concentrations of bis(2 ethylhexyl)phthalate in Blind Pass cores (TEL = threshold effective level, PEL = possible effective level [MacDonald, 1994], red = North End Channel, yellow = Mid Channel).

5.6 Spatial Distribution of C₈-C₄₀ Total Petroleum Hydrocarbons

To depict spatial distribution of petroleum hydrocarbons, the Blind Pass sediment core petroleum hydrocarbon concentration data were divided into four, 1-meter depth intervals (0-99 m, 100-199 cm, 200-299 cm, and 300-399 cm).

The 0-99 cm core depth intervals contained five sediment cores which had total petroleum hydrocarbon concentrations above detection limits. These sediment cores were located in the Mid and South Channels of Blind Pass (Figure 30). The 100-199 cm depth intervals had a total of eight sediment cores containing total petroleum hydrocarbon concentrations above detection limits. The sediment cores were located from the North End Channel to the Shoal area of Blind Pass (Figure 31). The 200-299 cm depth intervals from the Mid Channel and Outside the Pass had 15 sediment cores with total petroleum hydrocarbon concentrations above detection limits (Figure 32). The 300-399 cm depth intervals had only two sediment cores containing total petroleum hydrocarbon concentrations above detection limits. These sediment cores were located in the South Channel and Shoal area of Blind Pass (Figure 33). One core in the South Channel (BP-81) contained the highest concentration of petroleum hydrocarbons found in this study (346.0 mg/Kg).

Petroleum Hydrocarbon Concentrations Sediment Core Depths (0-99 cm)



Figure 30: Spatial distribution of total petroleum hydrocarbons at the 0-99 cm depth interval in Blind Pass.

Petroleum Hydrocarbon Concentrations Sediment Core Depths (100-199 cm)



Figure 31: Spatial distribution of total petroleum hydrocarbons at the 100-199 cm depth interval in Blind Pass.

Petroleum Hydrocarbon Concentrations Sediment Core Depths (200-299 cm)



Figure 32: Spatial distribution of total petroleum hydrocarbons at the 200-299 cm depth interval in Blind Pass.

Petroleum Hydrocarbon Concentrations Sediment Core Depths (300-399 cm)



Figure 33: Spatial distribution of total petroleum hydrocarbons at the 300-399 cm depth interval in Blind Pass.

5.7 FFD Probe Analysis

Several sediment types were examined using the FFD probe (Table 3). The FFD probe of LFFD value refers to the lighter fuels/soils that fluoresce at wavelengths of 280-450 nm, and HFFD refers to heavier fuels/darker soils that fluoresce at wavelengths greater than 450 nm. Analysis of the different sediment types with the FFD probe revealed that the lighter-colored sand and shell hash had the highest voltage output (Figure 34). In contrast, a mixture of mud, sand, and shells had the lowest output (Figure 34). Therefore, the FFD probe produced a higher voltage output for lighter-colored sand and lower output for darker sediments, which is why the lighter-colored sand produced the larger signal. The shell hash was quite similar in texture, but produced the highest output due to the fluorescence of calcium carbonate. In general, the LFFD values ranged from 0.2278 v-0.3501 v and the HFFD values ranged from 0.1060 v-0.1687 v for all sediment types tested in Blind Pass.

Sediment Type	LFFD	HFFD
Mud-Sand-Shell-Mixture	0.2366	0.1072
Mud-Sand Mixture	0.2532	0.1190
Sand	0.2722	0.1244
Shell Hash	0.3036	0.1680
Mud-Clay	0.2381	0.1104
Organic-Shell Mixture	0.2715	0.1350
Sand-Shell Mixture	0.2905	0.1399

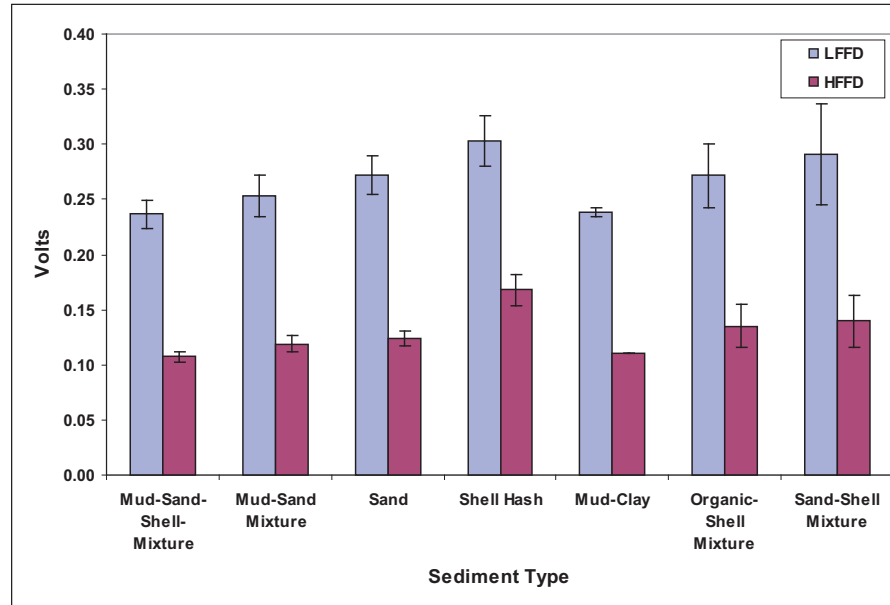

Figure 34: Average fluorescence of sediment types from Blind Pass using the FFD probe.

The FFD probe analyses for all Blind Pass sediment cores are presented in Appendix B. Figures 35-56 show the FFD probe analyses of sediment cores that contained samples which exhibited concentrations of total petroleum hydrocarbons above detection limits. Due to the compaction of the sediment cores during collection, the blue-shaded region on the graphs show the general location of the sample collected from each core for GC/FID analysis. The corrected depth and GC/FID result for each sample is also listed in the blue-shaded region.

Many of the sediment cores produced peaks of fluorescence when the FFD probe was pushed down the length of the core, but no peaks were higher than the background fluorescence of the native sediments. Since the FFD probe was received later during the study, some samples were collected before the FFD probe analysis which is why some of the samples were collected from regions in the core that show no peaks in fluorescence. These samples were collected based on either the presence of dark laminations within the sediment core or chosen at random intervals. Several peaks of fluorescence produced by the FFD probe did contain detectable levels of total petroleum hydrocarbons when analyzed by CG/FID. However, a greater number of those peaks exhibited undetectable levels of total petroleum hydrocarbons.

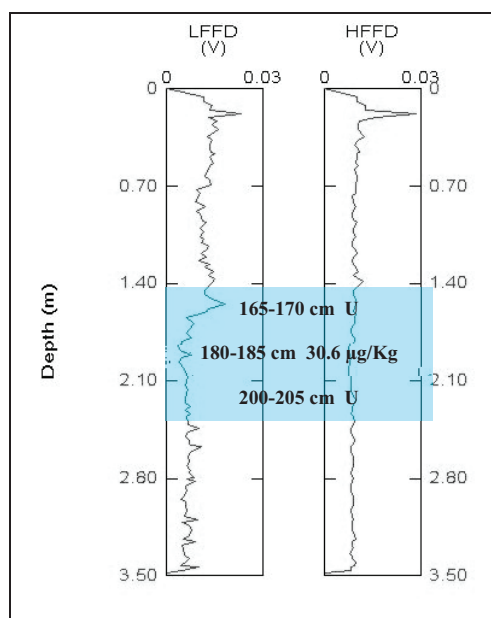

Figure 35: FFD probe analysis of sediment core BP-97.

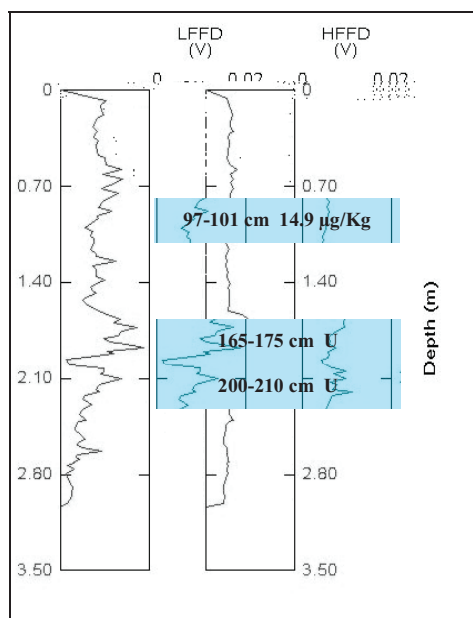

Figure 36: FFD probe analysis of sediment core BP-35.

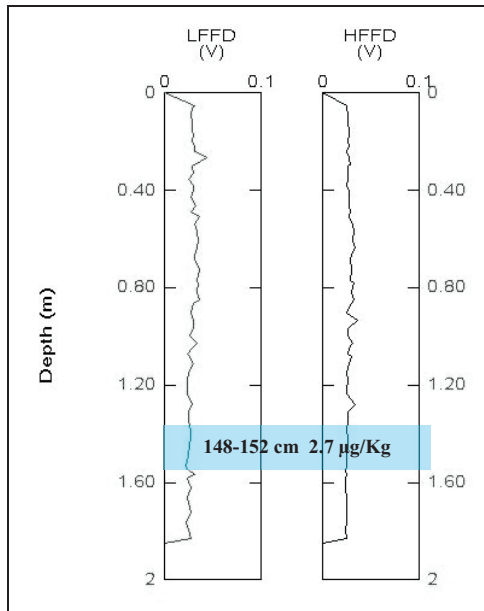

Figure 37: FFD probe analysis of sediment core BP-59.

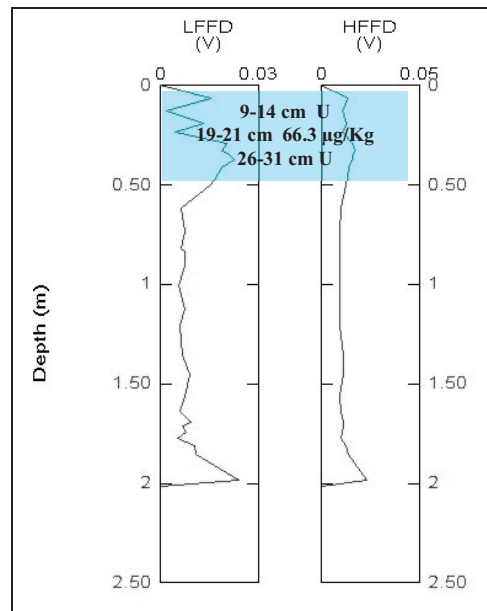

Figure 38: FFD probe analysis of sediment core BP-70.

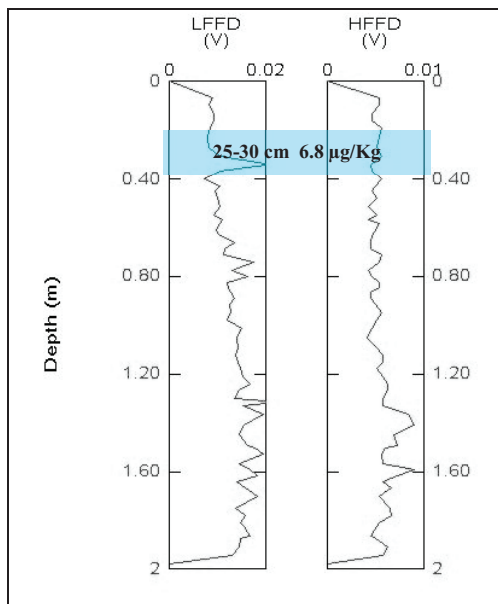

Figure 39: FFD probe analysis of sediment core BP-73.

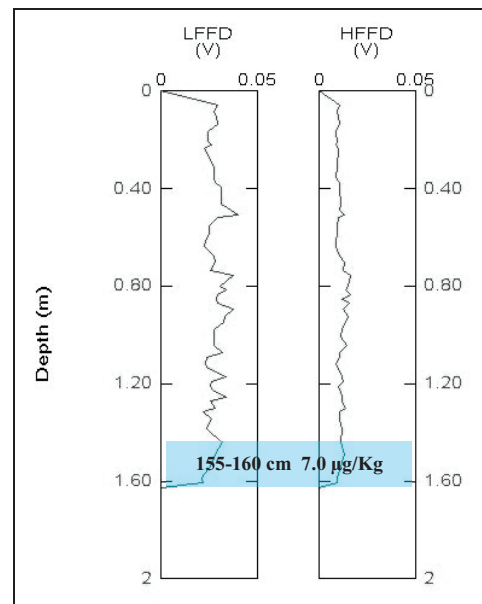

Figure 40: FFD probe analysis of sediment core BP-76.

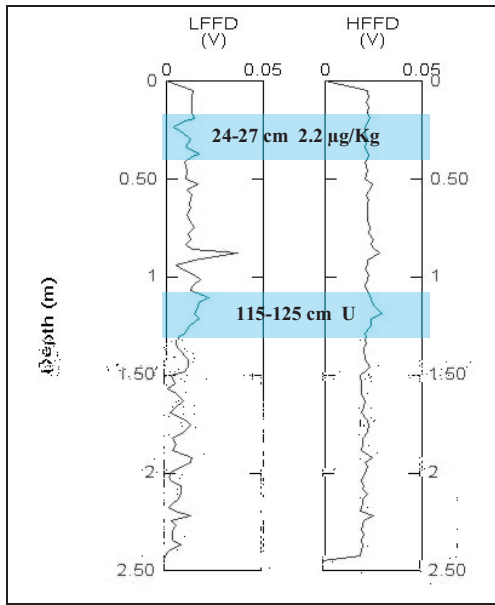

Figure 41: FFD probe analysis of sediment core BP-82.

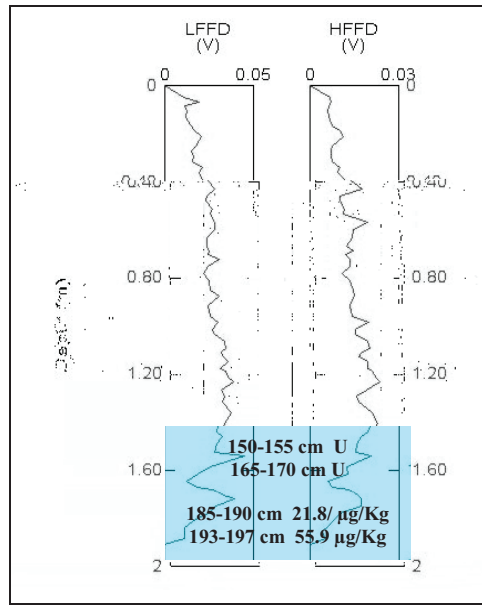

Figure 42: FFD probe analysis of sediment core BP-1.

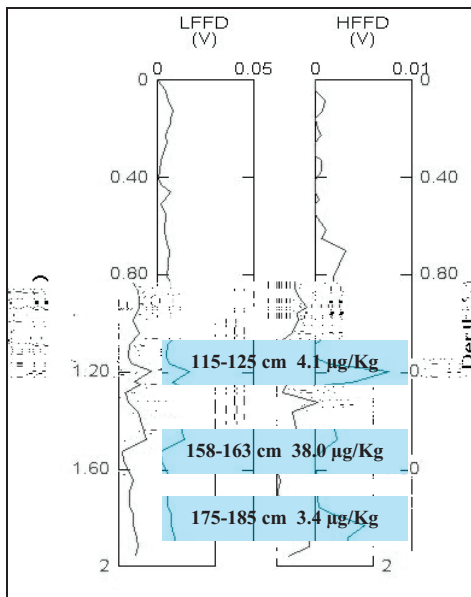

Figure 43: FFD probe analysis of sediment core BP-39.

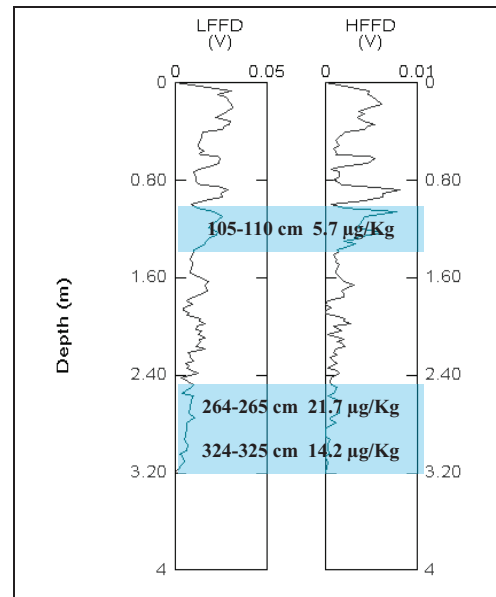

Figure 44: FFD probe analysis of sediment core BP-24.

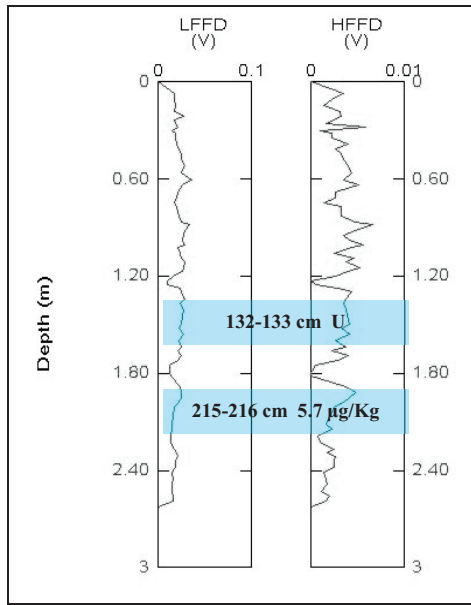

Figure 45: FFD probe analysis of sediment core BP-26.

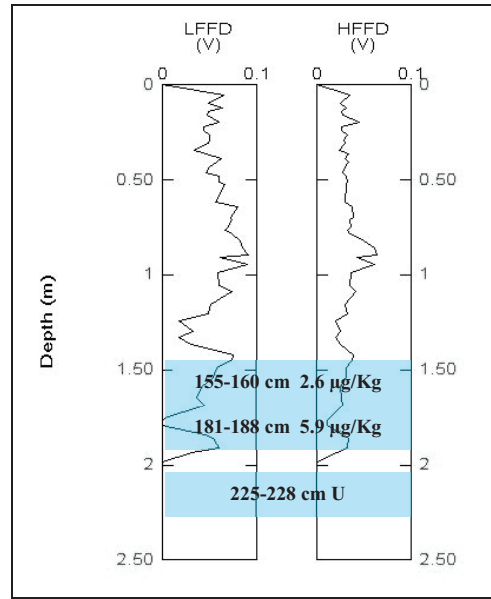

Figure 46: FFD probe analysis of sediment core BP-31.

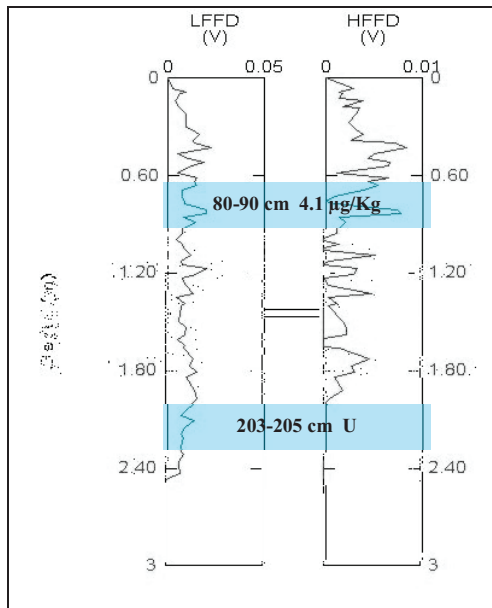

Figure 47: FFD probe analysis of sediment core BP-40.

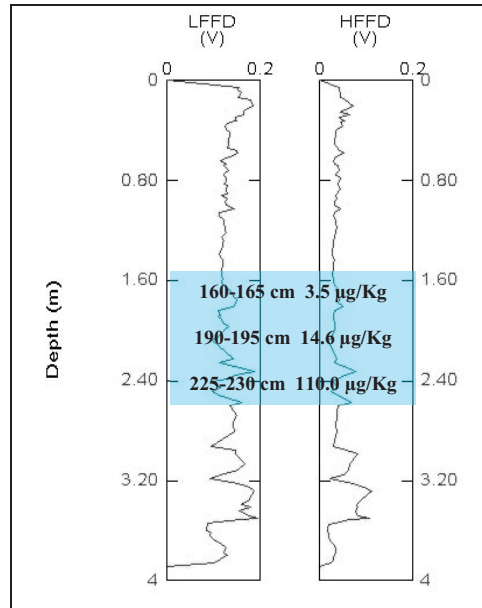

Figure 48: FFD probe analysis of sediment core BP-45.

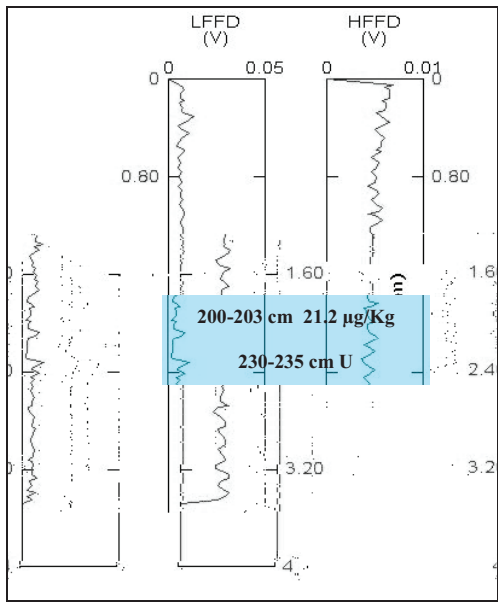

Figure 49: FFD probe analysis of sediment core BP-86.

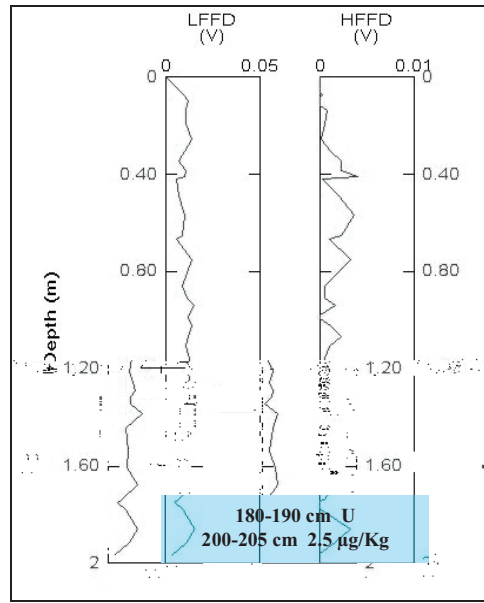

Figure 50: FFD probe analysis of sediment core BP-91.

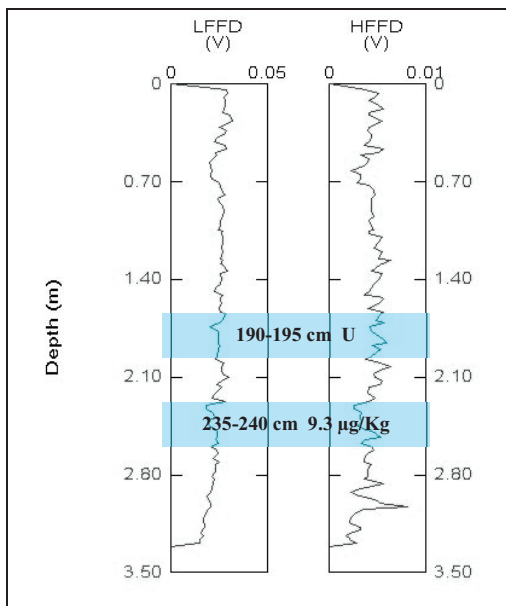

Figure 51: FFD probe analysis of sediment core BP-C.

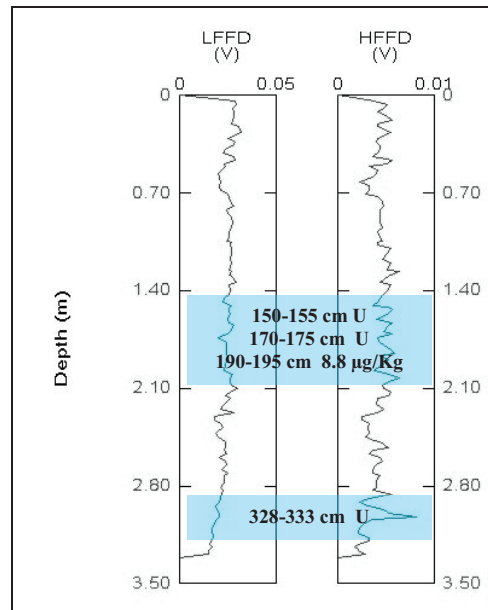

Figure 52: FFD probe analysis of sediment core BP-57.

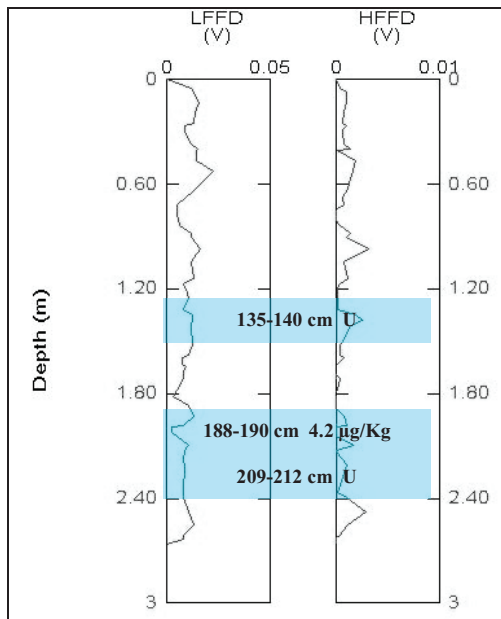

Figure 53: FFD probe analysis of sediment core BP-88.

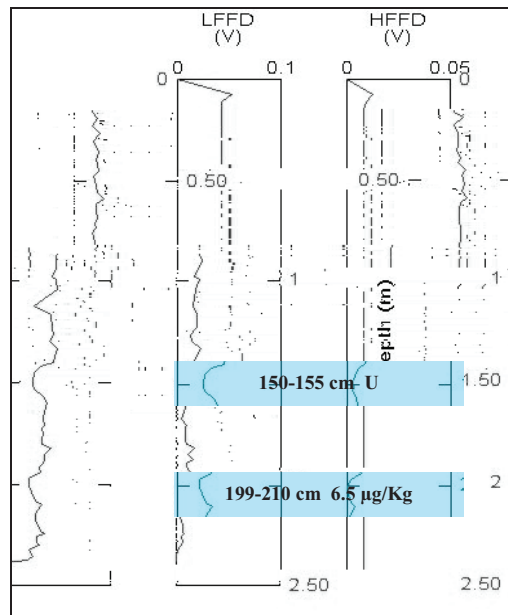

Figure 54: FFD probe analysis of sediment core BP-90.

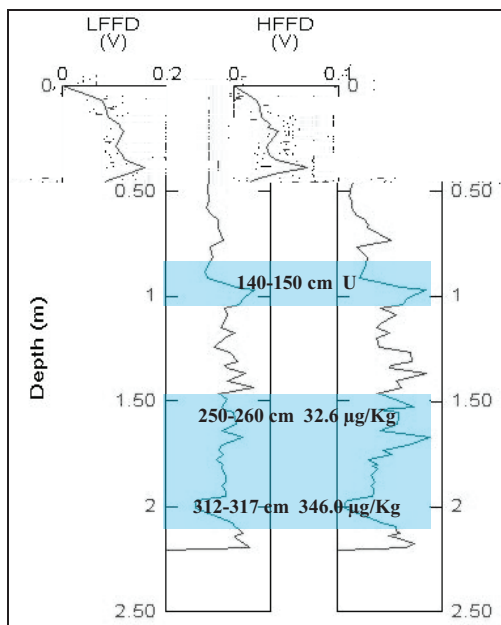

Figure 55: FFD probe analysis of sediment core BP-81.

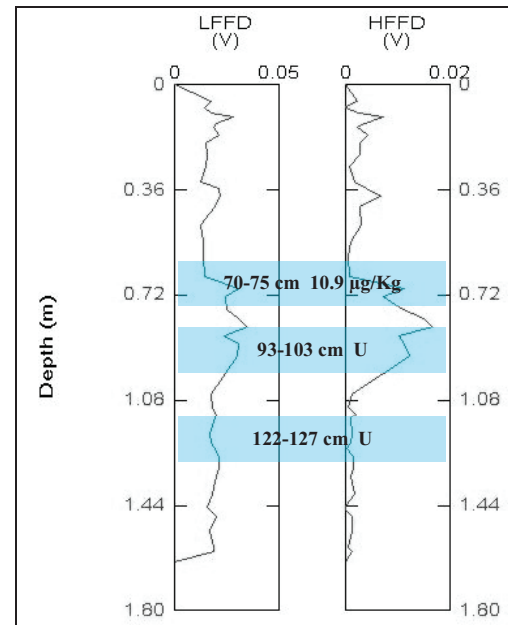

Figure 56: FFD probe analysis of sediment core BP-83.

6. Discussion

Blind Pass intra-core and spatial distribution of total petroleum hydrocarbons was found to be generally low. Speciation studies using GC/MS also revealed levels of individual hydrocarbons in all but one case to be below the threshold levels described in the literature (MacDonald, 1994). The presence of detectable hydrocarbons was, in most cases, not visually evident or restricted to specific sediment types. In several instances, layers within a single core exhibited above- and below-detection values. In addition, petroleum hydrocarbons were not concentrated in specific localities within Blind Pass, but several localities in all regions examined exhibited above-detection values. In many cases, the 100-300 cm level in the cores contained horizons at which above-detection values were found. At relatively shallow depths in five cores, concentrations of “lighter” petroleum hydrocarbons were found distinct in composition from the “heavier” oil anticipated to be found residually from the spill site and from the *Bouchard 155* heating oil No. 6 reference sample. The fuel fluorescence detection instrumentation was evaluated in this study and, from our calibration and test studies, appears sensitive to sediment type and more efficient at detection of lighter-weight petroleum hydrocarbons.

Based on the type of oil documented to be released in the environment during the 1993 spill and characterization of the *Bouchard 155* sample, the hydrocarbons recovered in this study were anticipated to predominantly be those of fuel oil No. 6, which is often referred to as “Bunker C.” Discussion of fuel oil is appropriate to better understand the analytical approach applied. Fuel oils are divided into two classes: distillates and residuals. Numbers 1 and 2 fuel oils are distillates and include kerosene, diesel, and home heating oil. Numbers 4, 5, and 6 fuel oils are residuals or black oils, and they all contain crude distillation tower bottoms (tar) to which cutter stocks (semi-refined or refined distillates) have been added. Number 4 fuel oil contains the most cutter stock, and No. 6 fuel oil contains the least. Commonly available fuel oils include No. 1, 2, 4, 5, and 6 (Wang *et al.*, 1994).

The boiling points, viscosities, and densities of these fuel oils increase with increasing number designation. The boiling point ranges for No. 1, 2, and 4 fuel oils are about 180-320°C, 175-340°C, and 150-480°C, respectively. Numbers 1 and 2 fuel oils contain hydrocarbons with 10-22 carbon atoms per molecule; the carbon range for No. 4 fuel oil is 22-40 atoms per molecule. Numbers 5 and 6 fuel oils have a boiling point range of 150-540°C but differ in the amounts of residue they contain: No. 5 fuel oil contains a small amount of residue, whereas No. 6 fuel oil contains a large amount. Numbers 5 and 6 fuel oils contain hydrocarbons with 28-90 carbon atoms per molecule. Fuel oils typically contain about 60% aliphatic hydrocarbons and 40% aromatic hydrocarbons (Wang *et al.*, 1994).

A sample of fuel oil No. 6 from the *Bouchard 155* tanker, which contaminated Blind Pass during an oil spill in August 1993, was analyzed by GC/MS for comparison with petroleum hydrocarbons found in sediment cores recently collected. Fuel oil No. 6 is characterized as having n-alkanes ranging from nC₁₃-nC₃₂ and polycyclic aromatic hydrocarbons (PAH's), which include benzene, naphthalene, phenanthrene, fluorene, pyrene, and chrysene (National Research Council, 1985). The reference sample obtained from the Louisiana State University's Department of Environmental Science for the *Bouchard 155* contained volatile (naphthalenes) and non-volatile hydrocarbons (chrysene, pyrene, fluorene, phenanthrene, and benzenes) (Figures 12 and 13).

The composition of petroleum and its products is complex and variable, which complicates measurement of total and individual petroleum hydrocarbons (TRPH). For this reason, the Florida Department of Environmental Protection's FL-PRO method with a detection limit of 0.01 mg/Kg was employed for this study. Weathering effects may further complicate the measurement of petroleum hydrocarbons in sediment. The GC/MS speciation method used in this study was also a FDEP-approved method which routinely has a detection level of 1 µg/Kg for individual petroleum hydrocarbons. When a petroleum product is released into water and incorporated into sediment, the product's composition immediately begins to change. The components with lower boiling points are volatilized, the more water-soluble components migrate in the sediment, and biodegradation can affect many other components. Within a short period, the oil in the sediment may have only some characteristics in common with the parent product. However, No. 6 fuel oil is remarkably persistent in the environment, and several studies have found this oil to be essentially unchanged even after several years in the sediment (Alimi, 2002; Douglas *et al.*, 1996). This may account for our ability to detect, although at relatively low concentrations, petroleum hydrocarbons with a similar make-up in the Blind Pass sediment. In this study, 22 of the 101 sediment cores collected within and just outside Blind Pass contained petroleum hydrocarbon contamination (Table 1) with several of the cores containing multiple layers of contamination.

The aliphatic fraction C₁₆-C₃₅ was evident in the sediment cores which had levels of petroleum hydrocarbons above detection limits (Figure 8). The *Bouchard 155* sample contained C₈-C₁₀, C₁₀-C₁₂, C₁₂-C₁₆, and C₁₆-C₃₅ aliphatic fractions with the C₁₆-C₃₅ comprising approximately 80% of the total (Figure 9). These fractions were at much lower percentages in the cores.

Interestingly, our preliminary studies indicate a systematic decrease in chrysene/pyrene ratios in the field samples compared to the *Bouchard 155* reference sample (Figures 13, 21, and 22). Changes in these ratios may be a good measure of weathering of petroleum hydrocarbons in the sediment, and we are in the process of examining differential weathering of oil in the cores.

The differences between the *Bouchard 155* and Blind Pass samples may be attributed to weathering effects over the past 15 years. Ezra *et al.* (2000), Wetzel (1995), and Nelson *et al.* (2006) found that lower molecular weight aliphatics were lost within the first several weeks to a year, possibly due to evaporation and/or dissolution.

The aromatic fraction of the sediment cores which exhibited petroleum hydrocarbon concentrations above detection limits were comprised mainly of C₁₂-C₁₆ and C₁₆-C₂₁ fractions (Figure 10). These are the same aromatic fractions found in the *Bouchard 155* sample (Figure 11) but at much lower levels, again likely due to weathering effects. The National Research Council (1985) has shown that weathered oil will exhibit losses of low molecular weight aromatic hydrocarbons early on after a spill, leaving only the heavy molecular weight species.

A mixture of ketone, ether, phthalates, and toluene comprised the hydrocarbons which were found in sediment cores BP-97 (North End Channel) (Figure 14) and BP-59, BP-70, BP-76 (Mid Channel) (Figures 15A-15C), and BP-82 (South Channel) (Figure 16C). Most of these contaminated sediment intervals were located at relatively shallow core depths, usually within

the first meter of sediment. These hydrocarbons do not resemble those of the *Bouchard 155*, which suggests the possibility of a different source of contamination such as storm water runoff.

Sediment cores BP-76 (Mid Channel) (Figure 15C), BP-39, BP-81, BP-83 (South Channel) (Figures 16A, 16B, and 16D), BP-24, BP-26, BP-31, BP-45, BP-91 (Shoal) (Figures 17A-E), BP-C, BP-88 and BP-90 (Outside Pass) (Figures 18A-C) contained sediment intervals which exhibited petroleum hydrocarbon concentrations high enough to perform individual hydrocarbon species analysis using GC/MS.

These samples were found to contain varying concentrations of phenanthrene, fluoranthene, benzo(a)anthracene, benzo(b)fluoranthene, benzo(a)pyrene, benzo(ghi)perylene, acenaphthylene, fluorene, anthracene, pyrene, chrysene, benzo(k)fluoranthene, indeno (1,2,3-cd)pyrene, and dibenzo(ah)anthracene. Most of these individual hydrocarbon species were also found at much higher concentrations in the *Bouchard 155* sample (Figures 12 and 13). Although the *Bouchard 155* sample contained significant amounts of naphthalenes, these were probably lost over time in the Blind Pass samples due to weathering effects. Naphthalene was found to decrease below detection levels within a week, while methylnaphthalene decreased below detection levels within two weeks of an oil spill involving No. 6 fuel oil (Ezra *et al.*, 2000). Wetzel (1995) also found naphthalenes to be lost within the first few weeks of exposure after a spill of No. 6 fuel oil, leaving behind only the phenanthrenes, benzenes, chrysenes, pyrenes, and fluorenes.

The petroleum hydrocarbons were predominately distributed within the 100-299 cm core intervals (Figures 31 and 32), with many above-detection samples near the 200 cm depth. Above-detection levels of the petroleum hydrocarbons in the sediment were not geographically localized within the Pass, but were found near the center of the channel and around the edges of the shoal. Several were also found outside the Pass. These concentrations may be related to differing current velocities and sedimentation rates in Blind Pass.

The individual petroleum hydrocarbon species were compared to known TEL and PEL values from MacDonald (1994) to assess contamination levels of specific petroleum hydrocarbons. As shown in Figures 19-28, in all but one case individual hydrocarbon concentrations were below their associated TEL values and much below their PEL values. The only individual hydrocarbon reaching concentrations above threshold levels was bis(2 ethylhexyl)phthalate, which was found to be twice as high as the TEL value, but about six times lower than its corresponding PEL value. This compound is a commonly used “plasticizer” and not found in fuel oil. It is unlikely the source of this compound was the original fuel spill. This information may be useful in assessing the toxic potential these contaminated sediments may pose to the environment.

The sediment cores were analyzed with a FFD probe, which measured the fluorescence of the sediments as they were pushed along the core, displaying the readout in voltage. Different sediment types were collected from the cores and analyzed with the FFD to provide an average of background fluorescence in Blind Pass. Sediment types consisted of shell hash, clean quartz sand, organics, clay, and a combination of each. The shell was found to produce the highest fluorescence, likely due to the highly fluorescent nature of calcium carbonate, while the clay produced the lowest fluorescence (Table 3, Figure 34). The manufacturer states that dark-colored

sediments produce lower fluorescence than lighter-colored sediments (Vertek, 2007). The graphs showing the fluorescence profile for each sediment core that contained samples with petroleum hydrocarbon concentrations above detection limits are in Figures 34-55. Many of the profiles exhibit peaks of fluorescence, but none were found to be above background levels found in Blind Pass. All but two of the above-detection, GC/FID-analyzed samples were below detection limits of the FFD probe (100 mg/Kg). The above FFD detection limit samples were from BP-45 (266-272 cm), 110.0 mg/Kg, and BP-81 (312-317 cm), 346.0 mg/Kg.

Subsamples were collected from BP-45 and BP-81 for GC/FID analysis before the FFD probe analysis was conducted. Subsequently, a sediment sample from each core was examined in the FFD probe. The results were below detection of the probe. These results may be related to sediment type since BP-45 was a clay/sand mixture, while BP-81 was a darker sand/shell mixture. The FFD probe's detection limit is 100 ppm oil from clean sand but may produce a lower fluorescence readout when used with oil from darker sediment (Vertek, 2007), as was the case for the above two samples.

The probe was tested with lighter hydrocarbons such as vacuum pump oil, olive oil, and gasoline, all of which produced a very pronounced peak of fluorescence. However, when heavier hydrocarbons were used, the fluorescence peak was only slightly above the background levels of clean Blind Pass sediment. A sample from the *Exxon Valdez* spill, which was "heavier" oil, was also analyzed by the FFD and found to exhibit a poor response. The results of this study suggest the FFD probe will likely be useful in detecting oils composed of lighter-weight petroleum hydrocarbons, but may not detect heavier-weight petroleum hydrocarbons in darker sediment. This may be especially evident in the detection of oil which has been exposed to weathering over extended periods of time.

7. Conclusions

1. Twenty-two of the 101 sediment cores collected in Blind Pass contained horizons with low, but above-detection levels (0.01mg/Kg) of C₈-C₄₀ total petroleum hydrocarbons using the Florida Department of Environmental Protection's FL-PRO methodology and GC/FID.
2. Detected concentrations of petroleum hydrocarbons were generally found at the 100-300 cm depths in Blind Pass cores.
3. Although petroleum hydrocarbon concentrations were not regionally localized, they were noted in the center of the Channel, around the edges of the Shoal area, and Outside the Pass.
4. Blind Pass GC/MS petroleum hydrocarbon speciation analyses indicated above-detection (>1 µg/Kg) of non-volatile individual hydrocarbons which were similar to those found in the *Bouchard 155* reference sample. Common hydrocarbon species included acenaphthene, fluorene, anthracene, acenaphthylene, chrysene, pyrene, benzo(a)pyrene, benzo(b)fluoranthene, fluoranthene, and phenanthrene.

5. Several sediment cores located at the North end of the channel and within the Mid channel contained phthalates, ketones, and ether. These may be from a source of hydrocarbon contamination distinct from the 1993 oil spill, possibly storm water runoff. Most of these were found in the upper 99 cm depth of the sediment cores.
6. The FFD probe detected peaks of fluorescence in all the sediment cores, but none were above background levels of the native sediments found in Blind Pass. All petroleum hydrocarbon concentrations were below the detection limits (100 mg/Kg) of the FFD, with the exception of two samples with concentrations of 110.0 mg/Kg and 346.0 mg/Kg. In addition to these samples being at or just above the detection limits of the FFD, they were present in dark-colored sediments which affect the fluorescence peaks of the FFD. These results indicate the samples may have been below detection levels for FFD analyses.
7. The FFD responded well when fresh oil was mixed in Blind Pass sediment and analyzed. However, it showed little response to a sample of degraded oil from the *Exxon Valdez* spill. Therefore, the FFD may not be sensitive enough to detect areas of petroleum hydrocarbon contamination when the hydrocarbons have been significantly degraded, as is the case at Blind Pass.

8. Acknowledgments

The authors would like to thank Dr. Ping Wang, Tanya Beck, Boris Radosavljevic, William Boyko, Tyler Weinand, and Kyle Kelso with the University of South Florida's Department of Geology for the collection and splitting of sediment cores from Blind Pass and for providing very helpful guidance during the project. We thank Tanya Beck for the help she provided with ArcGIS and production of the sediment core sampling map of Blind Pass for all the progress reports and final report. We would like to thank Scott Miles of Louisiana State University's Department of Environmental Studies for providing us with a reference sample from the 1993 oil spill involving the *Bouchard 155*, which was very helpful in the speciation analysis. Thanks are extended to Mr. Douglas Rosen of the USACE-Jacksonville District (now retired) for his support and guidance during the project. Steve Long, Florida-Spectrum, was invaluable for his interest and help in processing samples. We would like to thank the CIMAS-RSMAS/AOML cooperative agreement for helping facilitate this study. The funding for this project was provided by the USACE Jacksonville District.

9. References

- Alimi, H. (2002). How to recognize a hydrocarbon fuel in the environment and estimate its age of release. Umweltbundesamt/Federal Environment Agency, Austria, 49-54.
- Douglas, G.S., A.E. Bence, R.C. Prince, S.I. McMillan, and E.L. Butler (1996). Environmental stability of selected petroleum hydrocarbon source and weathering ratios. *Environmental Science and Technology*, 30:2332-2339.
- Ezra, S., S. Feinstein, I. Pelly, D. Bauman, and I. Miloslavsky (2000). Weathering of fuel oil spill on the east Mediterranean coast, Ashod, Israel. *Organic Geochemistry*, 31:1733-1741.
- MacDonald, D.D. (1994). *Approach to the Assessment of Sediment Quality in Florida Coastal Waters. Volume 1: Development and Evaluation of Sediment Quality Assessment Guidelines*. Report prepared for the Florida Department of Environmental Protection, 123 pp.
- National Research Council (1985). *Oil in the Sea: Inputs, Fates, and Effects*. National Academy Press, Washington, D.C., 601 pp.
- Nelson, R.K., B.M. Kile, D.L. Plata, S.P. Sylva, L. Xu, C.M. Reddy, R.B. Gaines, G.S. Frysinger, and S.E. Reichenbach (2006). Tracking the weathering of an oil spill with comprehensive two-dimensional gas chromatography. *Environmental Forensics*, 7:33-44.
- SQuiRT (1999). Screening Quick References Tables. NOAA-Office of Response and Restoration: http://response.restoration.noaa.gov/book_shelf/122_NEW-SQuiRTs.pdf.
- Urquhart-Donnelly, J., S. Fluke, E.J. O'Connor, and G.S. Mauseth (2000). 1993 Tampa Bay oil spill: A tale of two NRDAS with one happy ending. *Proceedings, NRDA Lessons Learned Workshop* (co-sponsored by the American Petroleum Institute, National Oceanographic and Atmospheric Administration, Texas General Land Office, Water Quality Insurance Syndicate, and the International P&I Clubs), New Orleans, LA, May 11-12, 2000, 32 pp.
- Vertek (2007). Operator's Manual, DataPack 2000FS.
- Wang, P., D.K. Tidwell, T.M. Beck, and N.C. Kraus (2007). Sedimentation patterns in a stabilized migratory inlet, Blind Pass, Florida. *Proceedings, Coastal Sediments '07 Conference*, New Orleans, LA, May 13-17, 2000. ASCE Press, 1377-1390.
- Wang, Z., M. Fingas, and G. Sergy (1994). Study of 22-year-old *Arrow* oil samples using biomarker compounds by GC/MS. *Environmental Science and Technology*, 28:1733-1746.
- Wetzel, D.L. (1995). Chemical fate of Bunker C fuel oil in a subtropical marine environment following a spill in Tampa Bay, Florida. M.S. Thesis, University of South Florida.

Appendix A

**Photographs, C₈-C₄₀ Table, Chromatograph, and Speciation Table for each
Sediment Subsample Which Exhibited Total Petroleum Hydrocarbon
Concentrations Above Detection Limits**

BLIND PASS SEDIMENT CORE BP-70 (24-26 CM)

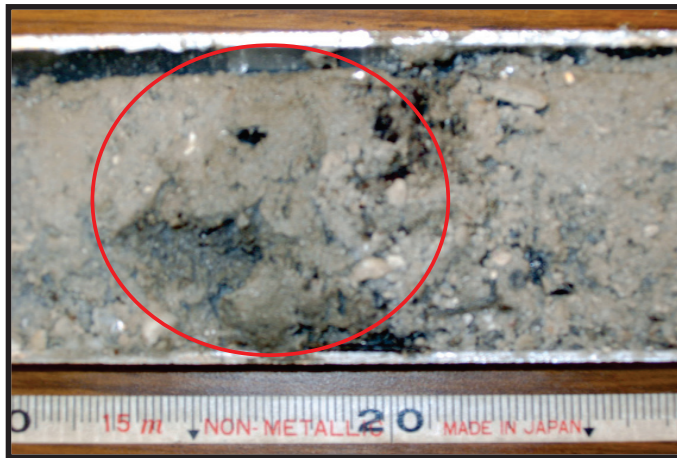

Red circle indicates area sampled for GC/MS analysis.

Core BP-70 (9-14 cm) - GC/MS Hydrocarbon Analysis Data						
PARAMETER	RESULT	QC	UNITS	MDL	PQL	METHOD
Percent Solids	81.9		%	0.1	0.3	EPA 160.3
FL-PRO (Petroleum Residual Organic Totals) Soil Dilution Factor = 1						
TOTAL PRO (C8-C40)	U	U	mg/Kg	0.01	0.03	FL-PRO

QC=Qualifier Code as defined by DEP 62-160; U=Undetected; MDL=Minimum Detection Limit; PQL=Practical Quantitation Limit.

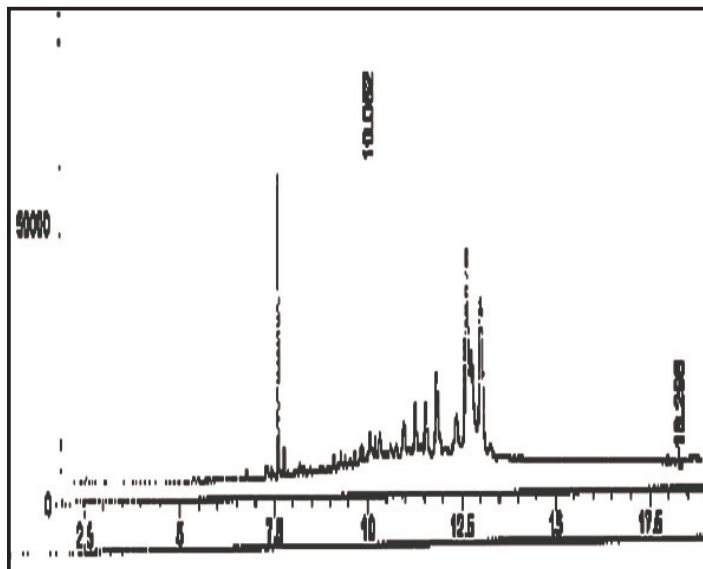

Chromatogram of sediment core BP-70 (24-26 cm).

Petroleum Hydrocarbon Speciation Analysis						
PARAMETER	RESULT	QC	UNITS	MDL	PQL	METHOD
Percent Solids	62.6		%	0.1	0.3	EPA 160.3
8260B VOA Compounds in Solids & Wastes GC/MS Dilution Factor = 1.44						
Methyl-tert-butyl-ether	U	U	µg/Kg	1.9	5.7	5030/8260B
Benzene	U	U	µg/Kg	0.85	2.55	5030/8260B
Toluene	8.12		µg/Kg	1.4	4.2	5030/8260B
Chlorobenzene	U	U	µg/Kg	2.3	6.9	5030/8260B
Ethylbenzene	U	U	µg/Kg	1.5	4.5	5030/8260B
M & p Xylene	U	U	µg/Kg	1.3	3.9	5030/8260B
o-Xylene	U	U	µg/Kg	1.1	3.3	5030/8260B
1,3-Dichlorobenzene	U	U	µg/Kg	3.2	9.6	5030/8260B
1,4-Dichlorobenzene	U	U	µg/Kg	2.0	6.0	5030/8260B
1,2-Dichlorobenzene	U	U	µg/Kg	3.5	10.5	5030/8260B
8270C Semivolatile Organics in Solids by GC/MS Dilution Factor = 1						
N-Nitrosodimethylamine	U	U	µg/Kg	69	207	3550/8270C
Phenol	U	U	µg/Kg	43	129	3550/8270C
2-Methyl Phenol (o-cresol)	U	U	µg/Kg	62	186	3550/8270C
3-Methyl Phenol (m-cresol)	U	U	µg/Kg	46	138	3550/8270C
4-Methyl Phenol (p-cresol)	U	U	µg/Kg	37	111	3550/8270C
Bis (2-Chloroethyl) Ether	U	U	µg/Kg	47	141	3550/8270C
2-Chlorophenol	U	U	µg/Kg	27.0	81.0	3550/8270C
1,3-Dichlorobenzene	U	U	µg/Kg	3.2	9.6	3550/8270C
1,4-Dichlorobenzene	U	U	µg/Kg	2.0	6.0	3550/8270C
Benzyl Alcohol	U	U	µg/Kg	3	9	3550/8270C
1,2-Dichlorobenzene	U	U	µg/Kg	3.5	10.5	3550/8270C
Bis (2-Chloroisopropyl) Ether	U	U	µg/Kg	47	141	3550/8270C
N-Nitrosodi-N-Proplamine	U	U	µg/Kg	24.0	72.0	3550/8270C
Hexachloroethane	U	U	µg/Kg	67	201	3550/8270C
Nitrobenzene	U	U	µg/Kg	38	114	3550/8270C
Isophorone	U	U	µg/Kg	76	228	3550/8270C
2-Nitrophenol	U	U	µg/Kg	78	234	3550/8270C
2,4-Dimethylphenol	U	U	µg/Kg	72	216	3550/8270C
Bis (2-Chloroethoxy)methane	U	U	µg/Kg	81	243	3550/8270C
2,4-Dichlorophenol	U	U	µg/Kg	59	177	3550/8270C
1,2,3-Trichlorobenzene	U	U	µg/Kg	32	96	3550/8270C
1,2,4-Trichlorobenzene	U	U	µg/Kg	42	126	3550/8270C
Naphthalene	U	U	µg/Kg	1	3	3550/8270C
Hexachlorobutadiene	U	U	µg/Kg	14	42	3550/8270C
4-Chloro-3-Methylphenol	U	U	µg/Kg	66	198	3550/8270C
1-Methylnaphthalene	U	U	µg/Kg	1	3	3550/8270C
2-Methylnaphthlene	U	U	µg/Kg	1	3	3550/8270C
Hexachlorocyclopentadiene	U	U	µg/Kg	41	123	3550/8270C
2,3,6-Trichlorophenol	U	U	µg/Kg	98	294	3550/8270C
2,4,5-Trichlorophenol	U	U	µg/Kg	60	180	3550/8270C
2,4,6-Trichlorophenol	U	U	µg/Kg	53	159	3550/8270C
2-Chloronaphthalene	U	U	µg/Kg	34	102	3550/8270C
Dimethyl Phthalate	U	U	µg/Kg	38	114	3550/8270C
Acenaphthylene	U	U	µg/Kg	2.0	6.0	3550/8270C
2,6-Dinitrotoluene	U	U	µg/Kg	26	78	3550/8270C
Acenaphthene	U	U	µg/Kg	1.3	3.9	3550/8270C
2,4-Dinitrophenol	U	U	µg/Kg	34	102	3550/8270C

Petroleum Hydrocarbon Speciation Analysis (continued)						
PARAMETER	RESULT	QC	UNITS	MDL	PQL	METHOD
2,4-Dinitrotoluene	U	U	µg/Kg	41	123	3550/8270C
4-Nitrophenol	U	U	µg/Kg	37	111	3550/8270C
Diethyl Phthalate	U	U	µg/Kg	35	105	3550/8270C
Fluorene	U	U	µg/Kg	1.0	3.0	3550/8270C
4-Chlorophenyl Phenyl Ether	U	U	µg/Kg	45	135	3550/8270C
4,6-Dinitro-2-Methylphenol	U	U	µg/Kg	36	108	3550/8270C
N-Nitrosodiphenylamine	U	U	µg/Kg	51	153	3550/8270C
4-Bromophenyl Phenyl Ether	U	U	µg/Kg	38	114	3550/8270C
Hexachlorobenzene	U	U	µg/Kg	36	108	3550/8270C
Pentachlorophenol	U	U	µg/Kg	1.7	5.1	3550/8270C
Phenanthrene	U	U	µg/Kg	2	6	3550/8270C
Anthracene	U	U	µg/Kg	0.6	1.8	3550/8270C
Di-N-Butyl Phthalate	366		µg/Kg	34	102	3550/8270C
Fluoranthene	U	U	µg/Kg	1.6	4.8	3550/8270C
Benzidine	U	U	µg/Kg	33	99	3550/8270C
Pyrene	U	U	µg/Kg	2	6	3550/8270C
Butyl Benzyl Phthalate	U	U	µg/Kg	50	150	3550/8270C
Benzo(A)Anthracene	U	U	µg/Kg	1	3	3550/8270C
3,3-Dichlorobenzidine	U	U	µg/Kg	100	300	3550/8270C
Chrysene	U	U	µg/Kg	1	3	3550/8270C
Bis (2 Ethylhexyl) Phthalate	66.6		µg/Kg	39	117	3550/8270C
Di-N-Octyl Phthalate	U	U	µg/Kg	44	132	3550/8270C
Benzo(B)Fluoranthene	U	U	µg/Kg	1	3	3550/8270C
Benzo(K)Fluoranthene	U	U	µg/Kg	1	3	3550/8270C
Benzo(A)Pyrene	U	U	µg/Kg	1	3	3550/8270C
Indeno(1,2,3-CD)Pyrene	U	U	µg/Kg	2	6	3550/8270C
Dibenzo (A,H) Anthracene	U	U	µg/Kg	2	6	3550/8270C
Benzo(G,H,I)Perylene	U	U	µg/Kg	2	6	3550/8270C
Bis-2-ethylhexyl Adipate	U	U	µg/Kg	33	99	3550/8270C
Aldrin	U	U	µg/Kg	1.0	3.0	3550/8270C
-BHC	U	U	µg/Kg	3.0	9.0	3550/8270C
-BHC	U	U	µg/Kg	3.0	9.0	3550/8270C
-BHC	U	U	µg/Kg	3.0	9.0	3550/8270C
-BHC (Lindane)	U	U	µg/Kg	1.0	3.0	3550/8270C
Clordane	U	U	µg/Kg	1.0	3.0	3550/8270C
4,4'-DDD	U	U	µg/Kg	2	6	3550/8270C
4,4'-DDE	U	U	µg/Kg	1.39	4017	3550/8270C
4,4'-DDT	U	U	µg/Kg	1.69	5.07	3550/8270C
Dieldrin	U	U	µg/Kg	0.840	2.520	3550/8270C
Endosulfan I	U	U	µg/Kg	1.100	3.300	3550/8270C
Endosulfan II	U	U	µg/Kg	1.60	4.80	3550/8270C
Endosulfan Sulfate	U	U	µg/Kg	1.70	5.10	3550/8270C
Endrin	U	U	µg/Kg	1.800	5.400	3550/8270C
Endrin Aldehyde	U	U	µg/Kg	1.900	5.700	3550/8270C
Heptachlor	U	U	µg/Kg	1.78	5.34	3550/8270C
Heptachlor Epoxide	U	U	µg/Kg	1.68	5.04	3550/8270C
Toxaphene	U	U	µg/Kg	1.90	5.70	3550/8270C
PCB-1016	U	U	µg/Kg	0.30	0.90	3550/8270C
PCB-1221	U	U	µg/Kg	0.30	0.90	3550/8270C
PCB-1232	U	U	µg/Kg	0.30	0.90	3550/8270C

Petroleum Hydrocarbon Speciation Analysis (continued)						
PARAMETER	RESULT	QC	UNITS	MDL	PQL	METHOD
PCB-1242	U	U	µg/Kg	0.30	0.90	3550/8270C
PCB-1254	U	U	µg/Kg	0.30	0.90	3550/8270C
PCB-1260	U	U	µg/Kg	0.30	0.90	3550/8270C
Dioxin	U	U	µg/Kg	30	90	3550/8270C
Azobenzene	U	U	µg/Kg	30	90	3550/8270C
Methoxychlor	U	U	µg/Kg	19	57	3550/8270C
Benzoic Acid	U	U	µg/Kg	30	90	3550/8270C
Aniline	U	U	µg/Kg	30	90	3550/8270C
4-Chloroaniline	U	U	µg/Kg	11	33	3550/8270C
Dibenzofuran	U	U	µg/Kg	30	90	3550/8270C
2-Nitroaniline	U	U	µg/Kg	37	111	3550/8270C
30Nitroaniline	U	U	µg/Kg	30	90	3550/8270C
4-Nitroaniline	U	U	µg/Kg	30	90	3550/8270C
Carbazole	U	U	µg/Kg	30	90	3550/8270C
2,6-Dichlorophenol	U	U	µg/Kg	17	51	3550/8270C
2,3,4,6-Tetrachlorophenol	U	U	µg/Kg	30	90	3550/8270C
2,3,5,6-Tetrachlorophenol	U	U	µg/Kg	30	90	3550/8270C
Pyridine	U	U	µg/Kg	67	201	3550/8270C
FL-PRO (Petroleum Residual Organic Totals) Soil Dilution Factor = 1						
TOTAL PRO (C8-C40)	66.3		mg/Kg	0.01	0.03	FL-PRO
TPHCWG TPH-CWG Speciation Method (Soils) Dilution Factor = 1						
C5-C7 Aromatics	U	U	µg/Kg	5.0	15.0	TPHCWG
C7-C8 Aromatics	U	U	µg/Kg	5.0	15.0	TPHCWG
C8-C10 Aromatics	U	U	µg/Kg	5.0	15.0	TPHCWG
C10-C12 Aromatics	U	U	µg/Kg	5.0	15.0	TPHCWG
C12-C16 Aromatics	U	U	µg/Kg	5.0	15.0	TPHCWG
C16-C21 Aromatics	U	U	µg/Kg	5.0	15.0	TPHCWG
C21-C35 Aromatics	U	U	µg/Kg	5.0	15.0	TPHCWG
C5-C6 Aliphatics	U	U	µg/Kg	5.0	15.0	TPHCWG
C6-C8 Aliphatics	U	U	µg/Kg	5.0	15.0	TPHCWG
C8-C10 Aliphatics	U	U	µg/Kg	5.0	15.0	TPHCWG
C10-C12 Aliphatics	U	U	µg/Kg	5.0	15.0	TPHCWG
C12-C16 Aliphatics	U	U	µg/Kg	5.0	15.0	TPHCWG
C16-C35 Aliphatics	54.3		µg/Kg	5.0	15.0	TPHCWG

QC=Qualifier Code as defined by DEP 62-160; U=Undetected; MDL=Minimum Detection Limit; PQL=Practical Quantation Limit.

BLIND PASS SEDIMENT CORE BP-70 (236-241 cm)



Red circle indicates area sampled for GC/MS analysis.

C ₈ -C ₄₀ Table						
PARAMETER	RESULT	QC	UNITS	MDL	PQL	METHOD
Percent Solids	93.9		%	0.1	0.3	EPA 160.3
FL-PRO (Petroleum Residual Organic Totals) Soil Dilution Factor = 1						
TOTAL PRO (C8-C40)	2.93	U	mg/Kg	0.01	0.03	FL-PRO

QC=Qualifier Code as defined by DEP 62-160; U=Undetected; I=In between the MDL and PQL; Q= Out of hold; MDL=Minimum Detection Limit; PQL=Practical Quantation Limit.

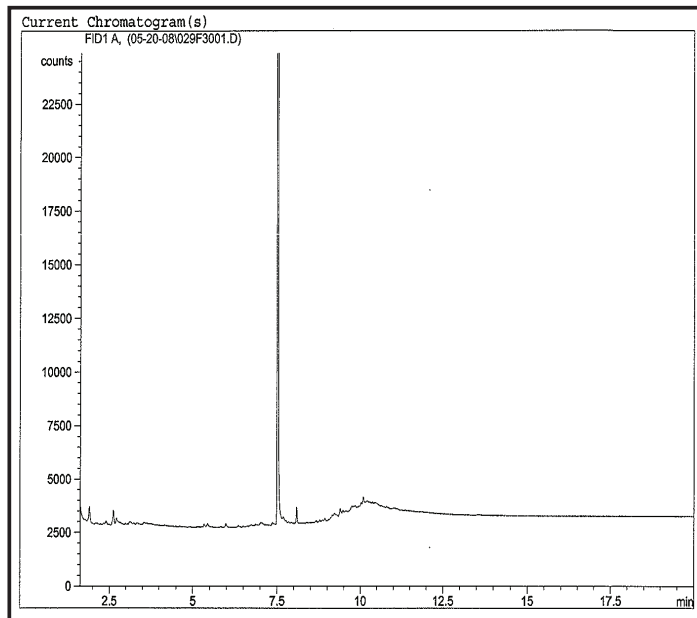

Chromatogram for sediment core BP-70 (236-241 cm).

Petroleum Hydrocarbon Speciation Analysis						
PARAMETER	RESULT	QC	UNITS	MDL	PQL	METHOD
Percent Solids	93.9		%	0.1	0.3	EPA 160.3
8260B VOA Compounds in Solids & Wastes GC/MS Dilution Factor = 1						
Methyl-tert-butyl-ether	U	U	µg/Kg	1.9	5.7	5030/8260B
Benzene	U	U	µg/Kg	0.85	2.55	5030/8260B
Toluene	U	U	µg/Kg	1.4	4.2	5030/8260B
Chlorobenzene	U	U	µg/Kg	2.3	6.9	5030/8260B
Ethylbenzene	U	U	µg/Kg	1.5	4.5	5030/8260B
M & p Xylene	U	U	µg/Kg	1.3	3.9	5030/8260B
o-Xylene	U	U	µg/Kg	1.1	3.3	5030/8260B
1,3-Dichlorobenzene	U	U	µg/Kg	3.2	9.6	5030/8260B
1,4-Dichlorobenzene	U	U	µg/Kg	2.0	6.0	5030/8260B
1,2-Dichlorobenzene	U	U	µg/Kg	3.5	10.5	5030/8260B
8270C Semivolatile Organics in Solids by GC/MS Dilution Factor = 1						
N-Nitrosodimethylamine	U	U	µg/Kg	69	207	3550/8270C
Phenol	U	U	µg/Kg	43	129	3550/8270C
2-Methyl Phenol (o-cresol)	U	U	µg/Kg	62	186	3550/8270C
3-Methyl Phenol (m-cresol)	U	U	µg/Kg	46	138	3550/8270C
4-Methyl Phenol (p-cresol)	U	U	µg/Kg	37	111	3550/8270C
Bis (2-Chloroethyl) Ether	U	U	µg/Kg	47	141	3550/8270C
2-Chlorophenol	U	U	µg/Kg	27.0	81.0	3550/8270C
1,3-Dichlorobenzene	U	U	µg/Kg	3.2	9.6	3550/8270C
1,4-Dichlorobenzene	U	U	µg/Kg	2.0	6.0	3550/8270C
Benzyl Alcohol	U	U	µg/Kg	3	9	3550/8270C
1,2-Dichlorobenzene	U	U	µg/Kg	3.5	10.5	3550/8270C
Bis (2-Chloroisopropyl) Ether	U	U	µg/Kg	47	141	3550/8270C
N-Nitrosodi-N-Proplamine	U	U	µg/Kg	24.0	72.0	3550/8270C
Hexachloroethane	U	U	µg/Kg	67	201	3550/8270C
Nitrobenzene	U	U	µg/Kg	38	114	3550/8270C
Isophorone	U	U	µg/Kg	76	228	3550/8270C
2-Nitrophenol	U	U	µg/Kg	78	234	3550/8270C
2,4-Dimethylphenol	U	U	µg/Kg	72	216	3550/8270C
Bis (2-Chloroethoxy)methane	U	U	µg/Kg	81	243	3550/8270C
2,4-Dichlorophenol	U	U	µg/Kg	59	177	3550/8270C
1,2,3-Trichlorobenzene	U	U	µg/Kg	32	96	3550/8270C
1,2,4-Trichlorobenzene	U	U	µg/Kg	42	126	3550/8270C
Naphthalene	U	U	µg/Kg	1	3	3550/8270C
Hexachlorobutadiene	U	U	µg/Kg	14	42	3550/8270C
4-Chloro-3-Methylphenol	U	U	µg/Kg	66	198	3550/8270C
1-Methylnaphthalene	U	U	µg/Kg	1	3	3550/8270C
2-Methylnaphthlene	U	U	µg/Kg	1	3	3550/8270C
Hexachlorocyclopentadiene	U	U	µg/Kg	41	123	3550/8270C
2,3,6-Trichlorophenol	U	U	µg/Kg	98	294	3550/8270C
2,4,5-Trichlorophenol	U	U	µg/Kg	60	180	3550/8270C
2,4,6-Trichlorophenol	U	U	µg/Kg	53	159	3550/8270C
2-Chloronaphthalene	U	U	µg/Kg	34	102	3550/8270C
Dimethyl Phthalate	U	U	µg/Kg	38	114	3550/8270C
Acenaphthylene	U	U	µg/Kg	2.0	6.0	3550/8270C
2,6-Dinitrotoluene	U	U	µg/Kg	26	78	3550/8270C
Acenaphthene	U	U	µg/Kg	1.3	3.9	3550/8270C
2,4-Dinitrophenol	U	U	µg/Kg	34	102	3550/8270C

Petroleum Hydrocarbon Speciation Analysis (continued)						
PARAMETER	RESULT	QC	UNITS	MDL	PQL	METHOD
2,4-Dinitrotoluene	U	U	µg/Kg	41	123	3550/8270C
4-Nitrophenol	U	U	µg/Kg	37	111	3550/8270C
Diethyl Phthalate	U	U	µg/Kg	35	105	3550/8270C
Fluorene	U	U	µg/Kg	1.0	3.0	3550/8270C
4-Chlorophenyl Phenyl Ether	U	U	µg/Kg	45	135	3550/8270C
4,6-Dinitro-2-Methylphenol	U	U	µg/Kg	36	108	3550/8270C
N-Nitrosodiphenylamine	U	U	µg/Kg	51	153	3550/8270C
4-Bromophenyl Phenyl Ether	U	U	µg/Kg	38	114	3550/8270C
Hexachlorobenzene	U	U	µg/Kg	36	108	3550/8270C
Pentachlorophenol	U	U	µg/Kg	1.7	5.1	3550/8270C
Phenanthrene	U	U	µg/Kg	2	6	3550/8270C
Anthracene	U	U	µg/Kg	0.6	1.8	3550/8270C
Di-N-Butyl Phthalate	U	U	µg/Kg	34	102	3550/8270C
Fluoranthene	U	U	µg/Kg	1.6	4.8	3550/8270C
Benzidine	U	U	µg/Kg	33	99	3550/8270C
Pyrene	U	U	µg/Kg	2	6	3550/8270C
Butyl Benzyl Phthalate	U	U	µg/Kg	50	150	3550/8270C
Benzo(A)Anthracene	U	U	µg/Kg	1	3	3550/8270C
3,3-Dichlorobenzidine	U	U	µg/Kg	100	300	3550/8270C
Chrysene	U	U	µg/Kg	1	3	3550/8270C
Bis (2 Ethylhexyl) Phthalate	U	U	µg/Kg	39	117	3550/8270C
Di-N-Octyl Phthalate	U	U	µg/Kg	44	132	3550/8270C
Benzo(B)Fluoranthene	U	U	µg/Kg	1	3	3550/8270C
Benzo(K)Fluoranthene	U	U	µg/Kg	1	3	3550/8270C
Benzo(A)Pyrene	U	U	µg/Kg	1	3	3550/8270C
Indeno(1,2,3-CD)Pyrene	U	U	µg/Kg	2	6	3550/8270C
Dibenzo (A,H) Anthracene	U	U	µg/Kg	2	6	3550/8270C
Benzo(G,H,I)Perylene	U	U	µg/Kg	2	6	3550/8270C
Bis-2-ethylhexyl Adipate	U	U	µg/Kg	33	99	3550/8270C
Aldrin	U	U	µg/Kg	1.0	3.0	3550/8270C
-BHC	U	U	µg/Kg	3.0	9.0	3550/8270C
-BHC	U	U	µg/Kg	3.0	9.0	3550/8270C
-BHC	U	U	µg/Kg	3.0	9.0	3550/8270C
-BHC (Lindane)	U	U	µg/Kg	1.0	3.0	3550/8270C
Clordane	U	U	µg/Kg	1.0	3.0	3550/8270C
4,4'-DDD	U	U	µg/Kg	2	6	3550/8270C
4,4'-DDE	U	U	µg/Kg	1.39	4017	3550/8270C
4,4'-DDT	U	U	µg/Kg	1.69	5.07	3550/8270C
Dieldrin	U	U	µg/Kg	0.840	2.520	3550/8270C
Endosulfan I	U	U	µg/Kg	1.100	3.300	3550/8270C
Endosulfan II	U	U	µg/Kg	1.60	4.80	3550/8270C
Endosulfan Sulfate	U	U	µg/Kg	1.70	5.10	3550/8270C
Endrin	U	U	µg/Kg	1.800	5.400	3550/8270C
Endrin Aldehyde	U	U	µg/Kg	1.900	5.700	3550/8270C
Heptachlor	U	U	µg/Kg	1.78	5.34	3550/8270C
Heptachlor Epoxide	U	U	µg/Kg	1.68	5.04	3550/8270C
Toxaphene	U	U	µg/Kg	1.90	5.70	3550/8270C
PCB-1016	U	U	µg/Kg	0.30	0.90	3550/8270C
PCB-1221	U	U	µg/Kg	0.30	0.90	3550/8270C
PCB-1232	U	U	µg/Kg	0.30	0.90	3550/8270C
PCB-1242	U	U	µg/Kg	0.30	0.90	3550/8270C

Petroleum Hydrocarbon Speciation Analysis (continued)						
PARAMETER	RESULT	QC	UNITS	MDL	PQL	METHOD
PCB-1248	U	U	µg/Kg	0.30	0.90	3550/8270C
PCB-1254	U	U	µg/Kg	0.30	0.90	3550/8270C
PCB-1260	U	U	µg/Kg	0.30	0.90	3550/8270C
Dioxin	U	U	µg/Kg	30	90	3550/8270C
Azobenzene	U	U	µg/Kg	30	90	3550/8270C
Methoxychlor	U	U	µg/Kg	19	57	3550/8270C
Benzoic Acid	U	U	µg/Kg	30	90	3550/8270C
Aniline	U	U	µg/Kg	30	90	3550/8270C
4-Chloroaniline	U	U	µg/Kg	11	33	3550/8270C
Dibenzofuran	U	U	µg/Kg	30	90	3550/8270C
2-Nitroaniline	U	U	µg/Kg	37	111	3550/8270C
30Nitroaniline	U	U	µg/Kg	30	90	3550/8270C
4-Nitroaniline	U	U	µg/Kg	30	90	3550/8270C
Carbazole	U	U	µg/Kg	30	90	3550/8270C
2,6-Dichlorophenol	U	U	µg/Kg	17	51	3550/8270C
2,3,4,6-Tetrachlorophenol	U	U	µg/Kg	30	90	3550/8270C
2,3,5,6-Tetrachlorophenol	U	U	µg/Kg	30	90	3550/8270C
Pyridine	U	U	µg/Kg	67	201	3550/8270C
FL-PRO (Petroleum Residual Organic Totals) Soil Dilution Factor = 1						
TOTAL PRO (C8-C40)	2.93		mg/Kg	0.01	0.03	FL-PRO
TPHCWG TPH-CWG Speciation Method (Soils) Dilution Factor = 1						
C5-C7 Aromatics	U	U	µg/Kg	5.0	15.0	TPHCWG
C7-C8 Aromatics	U	U	µg/Kg	5.0	15.0	TPHCWG
C8-C10 Aromatics	U	U	µg/Kg	5.0	15.0	TPHCWG
C10-C12 Aromatics	U	U	µg/Kg	5.0	15.0	TPHCWG
C12-C16 Aromatics	U	U	µg/Kg	5.0	15.0	TPHCWG
C16-C21 Aromatics	U	U	µg/Kg	5.0	15.0	TPHCWG
C21-C35 Aromatics	U	U	µg/Kg	5.0	15.0	TPHCWG
C5-C6 Aliphatics	U	U	µg/Kg	5.0	15.0	TPHCWG
C6-C8 Aliphatics	U	U	µg/Kg	5.0	15.0	TPHCWG
C8-C10 Aliphatics	U	U	µg/Kg	5.0	15.0	TPHCWG
C10-C12 Aliphatics	U	U	µg/Kg	5.0	15.0	TPHCWG
C12-C16 Aliphatics	U	U	µg/Kg	5.0	15.0	TPHCWG
C16-C35 Aliphatics	2930		µg/Kg	5.0	15.0	TPHCWG

QC=Qualifier Code as defined by DEP 62-160; U=Undetected; MDL=Minimum Detection Limit; PQL=Practical Quantization Limit.

BLIND PASS SEDIMENT CORE BP-57 (229-234 cm)



Red circle indicates area sampled for GC/MS.

C₈-C₄₀ Table						
PARAMETER	RESULT	QC	UNITS	MDL	PQL	METHOD
Percent Solids	70.5		%	0.1	0.3	EPA 160.3
FL-PRO (Petroleum Residual Organic Totals) Soil Dilution Factor = 1						
TOTAL PRO (C8-C40)	18.8		mg/Kg	0.01	0.03	FL-PRO

QC=Qualifier Code as defined by DEP 62-160; U=Undetected; I=In between the MDL and PQL; Q= Out of hold; MDL=Minimum Detection Limit; PQL=Practical Quantation Limit.

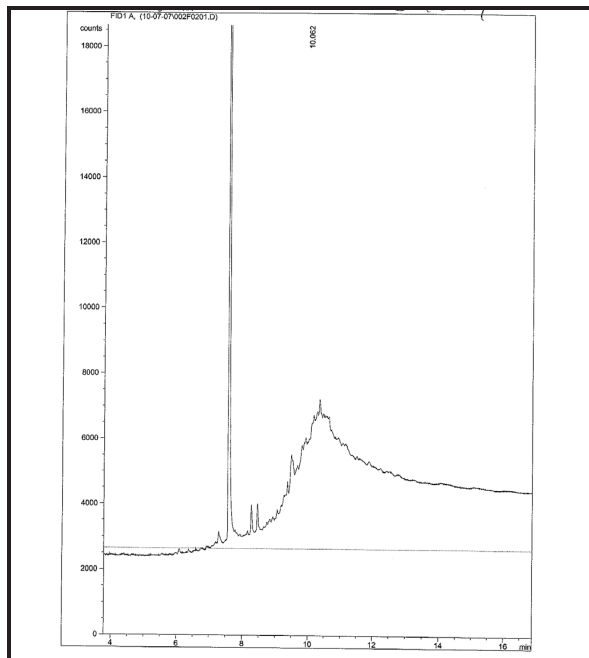

Chromatogram for sediment core BP-57 (229-234 cm).

NO PETROLEUM HYDROCARBON SPECTIATION ANALYSIS

BLIND PASS SEDIMENT CORE BP-45 (189-194 cm)



Red circle indicates area sampled for GC/MS analysis.

C₈-C₄₀ Table						
PARAMETER	RESULT	QC	UNITS	MDL	PQL	METHOD
Percent Solids	83.6		%	0.1	0.3	EPA 160.3
FL-PRO (Petroleum Residual Organic Totals) Soil Dilution Factor = 1						
TOTAL PRO (C8-C40)	3.54	U	mg/Kg	0.01	0.03	FL-PRO

QC=Qualifier Code as defined by DEP 62-160; U=Undetected; I=In between the MDL and PQL; Q= Out of hold; MDL=Minimum Detection Limit; PQL=Practical Quantation Limit.

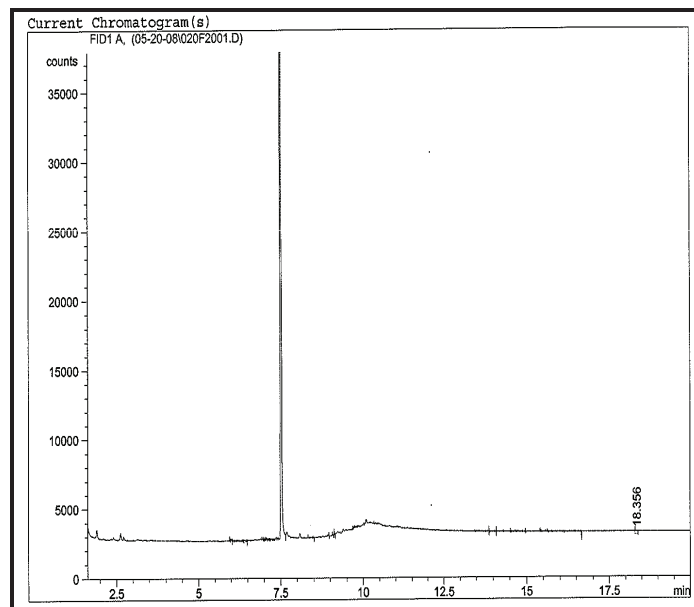

Chromatogram for sediment core BP-45 (189-194 cm).

Petroleum Hydrocarbon Speciation Analysis						
PARAMETER	RESULT	QC	UNITS	MDL	PQL	METHOD
Percent Solids	83.6		%	0.1	0.3	EPA 160.3
8260B VOA Compounds in Solids & Wastes GC/MS Dilution Factor = 1						
Methyl-tert-butyl-ether	U	U	µg/Kg	1.9	5.7	5030/8260B
Benzene	U	U	µg/Kg	0.85	2.55	5030/8260B
Toluene	U	U	µg/Kg	1.4	4.2	5030/8260B
Chlorobenzene	U	U	µg/Kg	2.3	6.9	5030/8260B
Ethylbenzene	U	U	µg/Kg	1.5	4.5	5030/8260B
M & p Xylene	U	U	µg/Kg	1.3	3.9	5030/8260B
o-Xylene	U	U	µg/Kg	1.1	3.3	5030/8260B
1,3-Dichlorobenzene	U	U	µg/Kg	3.2	9.6	5030/8260B
1,4-Dichlorobenzene	U	U	µg/Kg	2.0	6.0	5030/8260B
1,2-Dichlorobenzene	U	U	µg/Kg	3.5	10.5	5030/8260B
8270C Semivolatile Organics in Solids by GC/MS Dilution Factor = 1						
N-Nitrosodimethylamine	U	U	µg/Kg	69	207	3550/8270C
Phenol	U	U	µg/Kg	43	129	3550/8270C
2-Methyl Phenol (o-cresol)	U	U	µg/Kg	62	186	3550/8270C
3-Methyl Phenol (m-cresol)	U	U	µg/Kg	46	138	3550/8270C
4-Methyl Phenol (p-cresol)	U	U	µg/Kg	37	111	3550/8270C
Bis (2-Chloroethyl) Ether	U	U	µg/Kg	47	141	3550/8270C
2-Chlorophenol	U	U	µg/Kg	27.0	81.0	3550/8270C
1,3-Dichlorobenzene	U	U	µg/Kg	3.2	9.6	3550/8270C
1,4-Dichlorobenzene	U	U	µg/Kg	2.0	6.0	3550/8270C
Benzyl Alcohol	U	U	µg/Kg	3	9	3550/8270C
1,2-Dichlorobenzene	U	U	µg/Kg	3.5	10.5	3550/8270C
Bis (2-Chloroisopropyl) Ether	U	U	µg/Kg	47	141	3550/8270C
N-Nitrosodi-N-Proplamine	U	U	µg/Kg	24.0	72.0	3550/8270C
Hexachloroethane	U	U	µg/Kg	67	201	3550/8270C
Nitrobenzene	U	U	µg/Kg	38	114	3550/8270C
Isophorone	U	U	µg/Kg	76	228	3550/8270C
2-Nitrophenol	U	U	µg/Kg	78	234	3550/8270C
2,4-Dimethylphenol	U	U	µg/Kg	72	216	3550/8270C
Bis (2-Chloroethoxy)methane	U	U	µg/Kg	81	243	3550/8270C
2,4-Dichlorophenol	U	U	µg/Kg	59	177	3550/8270C
1,2,3-Trichlorobenzene	U	U	µg/Kg	32	96	3550/8270C
1,2,4-Trichlorobenzene	U	U	µg/Kg	42	126	3550/8270C
Naphthalene	U	U	µg/Kg	1	3	3550/8270C
Hexachlorobutadiene	U	U	µg/Kg	14	42	3550/8270C
4-Chloro-3-Methylphenol	U	U	µg/Kg	66	198	3550/8270C
1-Methylnaphthalene	U	U	µg/Kg	1	3	3550/8270C
2-Methylnaphthlene	U	U	µg/Kg	1	3	3550/8270C
Hexachlorocyclopentadiene	U	U	µg/Kg	41	123	3550/8270C
2,3,6-Trichlorophenol	U	U	µg/Kg	98	294	3550/8270C
2,4,5-Trichlorophenol	U	U	µg/Kg	60	180	3550/8270C
2,4,6-Trichlorophenol	U	U	µg/Kg	53	159	3550/8270C
2-Chloronaphthalene	U	U	µg/Kg	34	102	3550/8270C
Dimethyl Phthalate	U	U	µg/Kg	38	114	3550/8270C
Acenaphthylene	U	U	µg/Kg	2.0	6.0	3550/8270C
2,6-Dinitrotoluene	U	U	µg/Kg	26	78	3550/8270C
Acenaphthene	U	U	µg/Kg	1.3	3.9	3550/8270C
2,4-Dinitrophenol	U	U	µg/Kg	34	102	3550/8270C

Petroleum Hydrocarbon Speciation Analysis (continued)						
PARAMETER	RESULT	QC	UNITS	MDL	PQL	METHOD
2,4-Dinitrotoluene	U	U	µg/Kg	41	123	3550/8270C
4-Nitrophenol	U	U	µg/Kg	37	111	3550/8270C
Diethyl Phthalate	U	U	µg/Kg	35	105	3550/8270C
Fluorene	U	U	µg/Kg	1.0	3.0	3550/8270C
4-Chlorophenyl Phenyl Ether	U	U	µg/Kg	45	135	3550/8270C
4,6-Dinitro-2-Methylphenol	U	U	µg/Kg	36	108	3550/8270C
N-Nitrosodiphenylamine	U	U	µg/Kg	51	153	3550/8270C
4-Bromophenyl Phenyl Ether	U	U	µg/Kg	38	114	3550/8270C
Hexachlorobenzene	U	U	µg/Kg	36	108	3550/8270C
Pentachlorophenol	U	U	µg/Kg	1.7	5.1	3550/8270C
Phenanthrene	U	U	µg/Kg	2	6	3550/8270C
Anthracene	U	U	µg/Kg	0.6	1.8	3550/8270C
Di-N-Butyl Phthalate	U	U	µg/Kg	34	102	3550/8270C
Fluoranthene	U	U	µg/Kg	1.6	4.8	3550/8270C
Benzidine	U	U	µg/Kg	33	99	3550/8270C
Pyrene	U	U	µg/Kg	2	6	3550/8270C
Butyl Benzyl Phthalate	U	U	µg/Kg	50	150	3550/8270C
Benzo(A)Anthracene	U	U	µg/Kg	1	3	3550/8270C
3,3-Dichlorobenzidine	U	U	µg/Kg	100	300	3550/8270C
Chrysene	U	U	µg/Kg	1	3	3550/8270C
Bis (2 Ethylhexyl) Phthalate	U	U	µg/Kg	39	117	3550/8270C
Di-N-Octyl Phthalate	U	U	µg/Kg	44	132	3550/8270C
Benzo(B)Fluoranthene	U	U	µg/Kg	1	3	3550/8270C
Benzo(K)Fluoranthene	U	U	µg/Kg	1	3	3550/8270C
Benzo(A)Pyrene	U	U	µg/Kg	1	3	3550/8270C
Indeno(1,2,3-CD)Pyrene	U	U	µg/Kg	2	6	3550/8270C
Dibenzo (A,H) Anthracene	U	U	µg/Kg	2	6	3550/8270C
Benzo(G,H,I)Perylene	U	U	µg/Kg	2	6	3550/8270C
Bis-2-ethylexyl Adipate	U	U	µg/Kg	33	99	3550/8270C
Aldrin	U	U	µg/Kg	1.0	3.0	3550/8270C
-BHC	U	U	µg/Kg	3.0	9.0	3550/8270C
-BHC	U	U	µg/Kg	3.0	9.0	3550/8270C
-BHC	U	U	µg/Kg	3.0	9.0	3550/8270C
-BHC (Lindane)	U	U	µg/Kg	1.0	3.0	3550/8270C
Clordane	U	U	µg/Kg	1.0	3.0	3550/8270C
4,4'-DDD	U	U	µg/Kg	2	6	3550/8270C
4,4'-DDE	U	U	µg/Kg	1.39	4017	3550/8270C
4,4'-DDT	U	U	µg/Kg	1.69	5.07	3550/8270C
Dieldrin	U	U	µg/Kg	0.840	2.520	3550/8270C
Endosulfan I	U	U	µg/Kg	1.100	3.300	3550/8270C
Endosulfan II	U	U	µg/Kg	1.60	4.80	3550/8270C
Endosulfan Sulfate	U	U	µg/Kg	1.70	5.10	3550/8270C
Endrin	U	U	µg/Kg	1.800	5.400	3550/8270C
Endrin Aldehyde	U	U	µg/Kg	1.900	5.700	3550/8270C
Heptachlor	U	U	µg/Kg	1.78	5.34	3550/8270C
Heptachlor Epoxide	U	U	µg/Kg	1.68	5.04	3550/8270C
Toxaphene	U	U	µg/Kg	1.90	5.70	3550/8270C
PCB-1016	U	U	µg/Kg	0.30	0.90	3550/8270C
PCB-1221	U	U	µg/Kg	0.30	0.90	3550/8270C
PCB-1232	U	U	µg/Kg	0.30	0.90	3550/8270C
PCB-1242	U	U	µg/Kg	0.30	0.90	3550/8270C

Petroleum Hydrocarbon Speciation Analysis (continued)						
PARAMETER	RESULT	QC	UNITS	MDL	PQL	METHOD
PCB-1248	U	U	µg/Kg	0.30	0.90	3550/8270C
PCB-1254	U	U	µg/Kg	0.30	0.90	3550/8270C
PCB-1260	U	U	µg/Kg	0.30	0.90	3550/8270C
Dioxin	U	U	µg/Kg	30	90	3550/8270C
Azobenzene	U	U	µg/Kg	30	90	3550/8270C
Methoxychlor	U	U	µg/Kg	19	57	3550/8270C
Benzoic Acid	U	U	µg/Kg	30	90	3550/8270C
Aniline	U	U	µg/Kg	30	90	3550/8270C
4-Chloroaniline	U	U	µg/Kg	11	33	3550/8270C
Dibenzofuran	U	U	µg/Kg	30	90	3550/8270C
2-Nitroaniline	U	U	µg/Kg	37	111	3550/8270C
30Nitroaniline	U	U	µg/Kg	30	90	3550/8270C
4-Nitroaniline	U	U	µg/Kg	30	90	3550/8270C
Carbazole	U	U	µg/Kg	30	90	3550/8270C
2,6-Dichlorophenol	U	U	µg/Kg	17	51	3550/8270C
2,3,4,6-Tetrachlorophenol	U	U	µg/Kg	30	90	3550/8270C
2,3,5,6-Tetrachlorophenol	U	U	µg/Kg	30	90	3550/8270C
Pyridine	U	U	µg/Kg	67	201	3550/8270C
FL-PRO (Petroleum Residual Organic Totals) Soil Dilution Factor = 1						
TOTAL PRO (C8-C40)	3.54		mg/Kg	0.01	0.03	FL-PRO
TPHCWG TPH-CWG Speciation Method (Soils) Dilution Factor = 1						
C5-C7 Aromatics	U	U	µg/Kg	5.0	15.0	TPHCWG
C7-C8 Aromatics	U	U	µg/Kg	5.0	15.0	TPHCWG
C8-C10 Aromatics	U	U	µg/Kg	5.0	15.0	TPHCWG
C10-C12 Aromatics	U	U	µg/Kg	5.0	15.0	TPHCWG
C12-C16 Aromatics	U	U	µg/Kg	5.0	15.0	TPHCWG
C16-C21 Aromatics	U	U	µg/Kg	5.0	15.0	TPHCWG
C21-C35 Aromatics	U	U	µg/Kg	5.0	15.0	TPHCWG
C5-C6 Aliphatics	U	U	µg/Kg	5.0	15.0	TPHCWG
C6-C8 Aliphatics	U	U	µg/Kg	5.0	15.0	TPHCWG
C8-C10 Aliphatics	U	U	µg/Kg	5.0	15.0	TPHCWG
C10-C12 Aliphatics	U	U	µg/Kg	5.0	15.0	TPHCWG
C12-C16 Aliphatics	U	U	µg/Kg	5.0	15.0	TPHCWG
C16-C35 Aliphatics	3540		µg/Kg	5.0	15.0	TPHCWG

QC=Qualifier Code as defined by DEP 62-160; U=Undetected; MDL=Minimum Detection Limit; PQL=Practical Quantization Limit.

BLIND PASS SEDIMENT CORE BP-45 (225-230 cm)

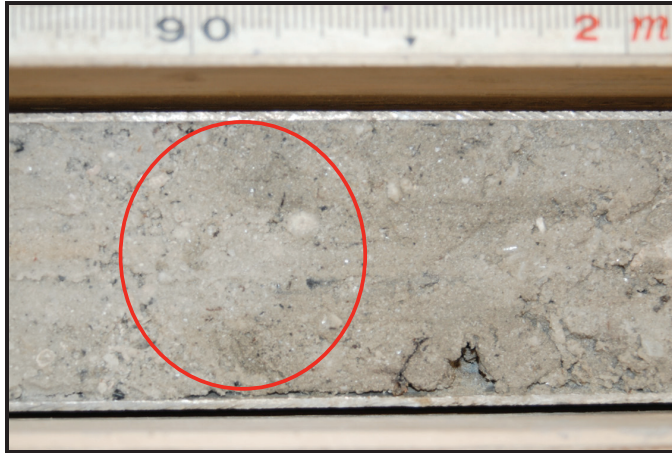

Red circle indicates area sampled for GC/MS analysis.

C₈-C₄₀ Table						
PARAMETER	RESULT	QC	UNITS	MDL	PQL	METHOD
Percent Solids	75.0		%	0.1	0.3	EPA 160.3
FL-PRO (Petroleum Residual Organic Totals) Soil Dilution Factor = 1						
TOTAL PRO (C8-C40)	14.6	U	mg/Kg	0.01	0.03	FL-PRO

QC=Qualifier Code as defined by DEP 62-160; U=Undetected; I=In between the MDL and PQL; Q= Out of hold; MDL=Minimum Detection Limit; PQL=Practical Quantation Limit.

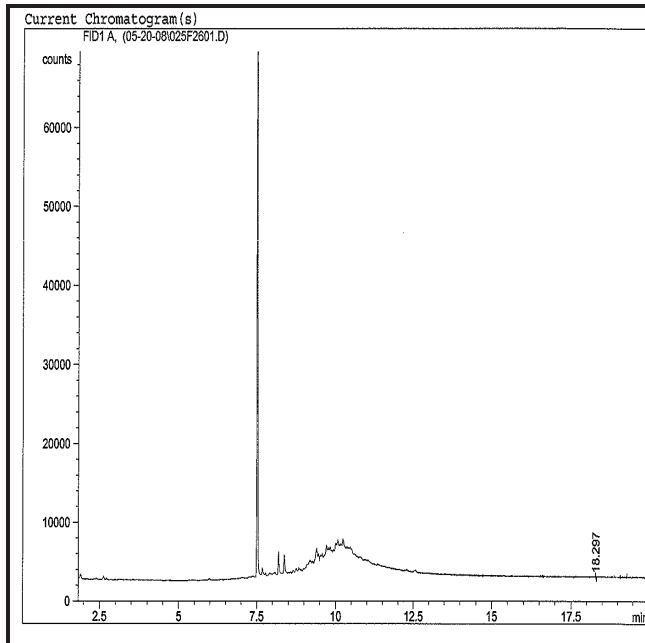

Chromatogram for sediment core BP-45 (225-230 cm).

Petroleum Hydrocarbon Speciation Analysis						
PARAMETER	RESULT	QC	UNITS	MDL	PQL	METHOD
Percent Solids	75.0		%	0.1	0.3	EPA 160.3
8260B VOA Compounds in Solids & Wastes GC/MS Dilution Factor = 1						
Methyl-tert-butyl-ether	U	U	µg/Kg	1.9	5.7	5030/8260B
Benzene	U	U	µg/Kg	0.85	2.55	5030/8260B
Toluene	U	U	µg/Kg	1.4	4.2	5030/8260B
Chlorobenzene	U	U	µg/Kg	2.3	6.9	5030/8260B
Ethylbenzene	U	U	µg/Kg	1.5	4.5	5030/8260B
M & p Xylene	U	U	µg/Kg	1.3	3.9	5030/8260B
o-Xylene	U	U	µg/Kg	1.1	3.3	5030/8260B
1,3-Dichlorobenzene	U	U	µg/Kg	3.2	9.6	5030/8260B
1,4-Dichlorobenzene	U	U	µg/Kg	2.0	6.0	5030/8260B
1,2-Dichlorobenzene	U	U	µg/Kg	3.5	10.5	5030/8260B
8270C Semivolatile Organics in Solids by GC/MS Dilution Factor = 1						
N-Nitrosodimethylamine	U	U	µg/Kg	69	207	3550/8270C
Phenol	U	U	µg/Kg	43	129	3550/8270C
2-Methyl Phenol (o-cresol)	U	U	µg/Kg	62	186	3550/8270C
3-Methyl Phenol (m-cresol)	U	U	µg/Kg	46	138	3550/8270C
4-Methyl Phenol (p-cresol)	U	U	µg/Kg	37	111	3550/8270C
Bis (2-Chloroethyl) Ether	U	U	µg/Kg	47	141	3550/8270C
2-Chlorophenol	U	U	µg/Kg	27.0	81.0	3550/8270C
1,3-Dichlorobenzene	U	U	µg/Kg	3.2	9.6	3550/8270C
1,4-Dichlorobenzene	U	U	µg/Kg	2.0	6.0	3550/8270C
Benzyl Alcohol	U	U	µg/Kg	3	9	3550/8270C
1,2-Dichlorobenzene	U	U	µg/Kg	3.5	10.5	3550/8270C
Bis (2-Chloroisopropyl) Ether	U	U	µg/Kg	47	141	3550/8270C
N-Nitrosodi-N-Proplamine	U	U	µg/Kg	24.0	72.0	3550/8270C
Hexachloroethane	U	U	µg/Kg	67	201	3550/8270C
Nitrobenzene	U	U	µg/Kg	38	114	3550/8270C
Isophorone	U	U	µg/Kg	76	228	3550/8270C
2-Nitrophenol	U	U	µg/Kg	78	234	3550/8270C
2,4-Dimethylphenol	U	U	µg/Kg	72	216	3550/8270C
Bis (2-Chloroethoxy)methane	U	U	µg/Kg	81	243	3550/8270C
2,4-Dichlorophenol	U	U	µg/Kg	59	177	3550/8270C
1,2,3-Trichlorobenzene	U	U	µg/Kg	32	96	3550/8270C
1,2,4-Trichlorobenzene	U	U	µg/Kg	42	126	3550/8270C
Naphthalene	U	U	µg/Kg	1	3	3550/8270C
Hexachlorobutadiene	U	U	µg/Kg	14	42	3550/8270C
4-Chloro-3-Methylphenol	U	U	µg/Kg	66	198	3550/8270C
1-Methylnaphthalene	U	U	µg/Kg	1	3	3550/8270C
2-Methylnaphthlene	U	U	µg/Kg	1	3	3550/8270C
Hexachlorocyclopentadiene	U	U	µg/Kg	41	123	3550/8270C
2,3,6-Trichlorophenol	U	U	µg/Kg	98	294	3550/8270C
2,4,5-Trichlorophenol	U	U	µg/Kg	60	180	3550/8270C
2,4,6-Trichlorophenol	U	U	µg/Kg	53	159	3550/8270C
2-Chloronaphthalene	U	U	µg/Kg	34	102	3550/8270C
Dimethyl Phthalate	U	U	µg/Kg	38	114	3550/8270C
Acenaphthylene	U	U	µg/Kg	2.0	6.0	3550/8270C
2,6-Dinitrotoluene	U	U	µg/Kg	26	78	3550/8270C
Acenaphthene	U	U	µg/Kg	1.3	3.9	3550/8270C
2,4-Dinitrophenol	U	U	µg/Kg	34	102	3550/8270C

Petroleum Hydrocarbon Speciation Analysis (continued)						
PARAMETER	RESULT	QC	UNITS	MDL	PQL	METHOD
2,4-Dinitrotoluene	U	U	µg/Kg	41	123	3550/8270C
4-Nitrophenol	U	U	µg/Kg	37	111	3550/8270C
Diethyl Phthalate	U	U	µg/Kg	35	105	3550/8270C
Fluorene	U	U	µg/Kg	1.0	3.0	3550/8270C
4-Chlorophenyl Phenyl Ether	U	U	µg/Kg	45	135	3550/8270C
4,6-Dinitro-2-Methylphenol	U	U	µg/Kg	36	108	3550/8270C
N-Nitrosodiphenylamine	U	U	µg/Kg	51	153	3550/8270C
4-Bromophenyl Phenyl Ether	U	U	µg/Kg	38	114	3550/8270C
Hexachlorobenzene	U	U	µg/Kg	36	108	3550/8270C
Pentachlorophenol	U	U	µg/Kg	1.7	5.1	3550/8270C
Phenanthrene	U	U	µg/Kg	2	6	3550/8270C
Anthracene	U	U	µg/Kg	0.6	1.8	3550/8270C
Di-N-Butyl Phthalate	U	U	µg/Kg	34	102	3550/8270C
Fluoranthene	37.9		µg/Kg	1.6	4.8	3550/8270C
Benzidine	U	U	µg/Kg	33	99	3550/8270C
Pyrene	31.0		µg/Kg	2	6	3550/8270C
Butyl Benzyl Phthalate	U	U	µg/Kg	50	150	3550/8270C
Benzo(A)Anthracene	21.0		µg/Kg	1	3	3550/8270C
3,3-Dichlorobenzidine	U	U	µg/Kg	100	300	3550/8270C
Chrysene	40.0		µg/Kg	1	3	3550/8270C
Bis (2 Ethylhexyl) Phthalate	U	U	µg/Kg	39	117	3550/8270C
Di-N-Octyl Phthalate	U	U	µg/Kg	44	132	3550/8270C
Benzo(B)Fluoranthene	26.1		µg/Kg	1	3	3550/8270C
Benzo(K)Fluoranthene	U	U	µg/Kg	1	3	3550/8270C
Benzo(A)Pyrene	15.4		µg/Kg	1	3	3550/8270C
Indeno(1,2,3-CD)Pyrene	1.91		µg/Kg	2	6	3550/8270C
Dibenzo (A,H) Anthracene	U	U	µg/Kg	2	6	3550/8270C
Benzo(G,H,I)Perylene	2.41		µg/Kg	2	6	3550/8270C
Bis-2-ethylexyl Adipate	U	U	µg/Kg	33	99	3550/8270C
Aldrin	U	U	µg/Kg	1.0	3.0	3550/8270C
-BHC	U	U	µg/Kg	3.0	9.0	3550/8270C
-BHC	U	U	µg/Kg	3.0	9.0	3550/8270C
-BHC	U	U	µg/Kg	3.0	9.0	3550/8270C
-BHC (Lindane)	U	U	µg/Kg	1.0	3.0	3550/8270C
Clordane	U	U	µg/Kg	1.0	3.0	3550/8270C
4,4'-DDD	U	U	µg/Kg	2	6	3550/8270C
4,4'-DDE	U	U	µg/Kg	1.39	4017	3550/8270C
4,4'-DDT	U	U	µg/Kg	1.69	5.07	3550/8270C
Dieldrin	U	U	µg/Kg	0.840	2.520	3550/8270C
Endosulfan I	U	U	µg/Kg	1.100	3.300	3550/8270C
Endosulfan II	U	U	µg/Kg	1.60	4.80	3550/8270C
Endosulfan Sulfate	U	U	µg/Kg	1.70	5.10	3550/8270C
Endrin	U	U	µg/Kg	1.800	5.400	3550/8270C
Endrin Aldehyde	U	U	µg/Kg	1.900	5.700	3550/8270C
Heptachlor	U	U	µg/Kg	1.78	5.34	3550/8270C
Heptachlor Epoxide	U	U	µg/Kg	1.68	5.04	3550/8270C
Toxaphene	U	U	µg/Kg	1.90	5.70	3550/8270C
PCB-1016	U	U	µg/Kg	0.30	0.90	3550/8270C
PCB-1221	U	U	µg/Kg	0.30	0.90	3550/8270C
PCB-1232	U	U	µg/Kg	0.30	0.90	3550/8270C
PCB-1242	U	U	µg/Kg	0.30	0.90	3550/8270C

Petroleum Hydrocarbon Speciation Analysis (continued)						
PARAMETER	RESULT	QC	UNITS	MDL	PQL	METHOD
PCB-1248	U	U	µg/Kg	0.30	0.90	3550/8270C
PCB-1254	U	U	µg/Kg	0.30	0.90	3550/8270C
PCB-1260	U	U	µg/Kg	0.30	0.90	3550/8270C
Dioxin	U	U	µg/Kg	30	90	3550/8270C
Azobenzene	U	U	µg/Kg	30	90	3550/8270C
Methoxychlor	U	U	µg/Kg	19	57	3550/8270C
Benzoic Acid	U	U	µg/Kg	30	90	3550/8270C
Aniline	U	U	µg/Kg	30	90	3550/8270C
4-Chloroaniline	U	U	µg/Kg	11	33	3550/8270C
Dibenzofuran	U	U	µg/Kg	30	90	3550/8270C
2-Nitroaniline	U	U	µg/Kg	37	111	3550/8270C
30Nitroaniline	U	U	µg/Kg	30	90	3550/8270C
4-Nitroaniline	U	U	µg/Kg	30	90	3550/8270C
Carbazole	U	U	µg/Kg	30	90	3550/8270C
2,6-Dichlorophenol	U	U	µg/Kg	17	51	3550/8270C
2,3,4,6-Tetrachlorophenol	U	U	µg/Kg	30	90	3550/8270C
2,3,5,6-Tetrachlorophenol	U	U	µg/Kg	30	90	3550/8270C
Pyridine	U	U	µg/Kg	67	201	3550/8270C
FL-PRO (Petroleum Residual Organic Totals) Soil Dilution Factor = 1						
TOTAL PRO (C8-C40)	14.6		mg/Kg	0.01	0.03	FL-PRO
TPHCWG TPH-CWG Speciation Method (Soils) Dilution Factor = 1						
C5-C7 Aromatics	U	U	µg/Kg	5.0	15.0	TPHCWG
C7-C8 Aromatics	U	U	µg/Kg	5.0	15.0	TPHCWG
C8-C10 Aromatics	U	U	µg/Kg	5.0	15.0	TPHCWG
C10-C12 Aromatics	U	U	µg/Kg	5.0	15.0	TPHCWG
C12-C16 Aromatics	U	U	µg/Kg	5.0	15.0	TPHCWG
C16-C21 Aromatics	171	U	µg/Kg	5.0	15.0	TPHCWG
C21-C35 Aromatics	U	U	µg/Kg	5.0	15.0	TPHCWG
C5-C6 Aliphatics	U	U	µg/Kg	5.0	15.0	TPHCWG
C6-C8 Aliphatics	U	U	µg/Kg	5.0	15.0	TPHCWG
C8-C10 Aliphatics	U	U	µg/Kg	5.0	15.0	TPHCWG
C10-C12 Aliphatics	U	U	µg/Kg	5.0	15.0	TPHCWG
C12-C16 Aliphatics	U	U	µg/Kg	5.0	15.0	TPHCWG
C16-C35 Aliphatics	14600		µg/Kg	5.0	15.0	TPHCWG

QC=Qualifier Code as defined by DEP 62-160; U=Undetected; MDL=Minimum Detection Limit; .QL=Practical Quantization Limit.

BLIND PASS SEDIMENT CORE BP-45 (266-272 cm)

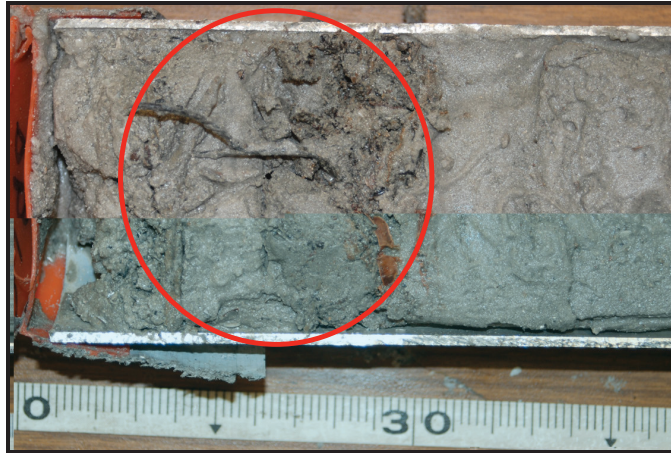

Red circle indicates area sampled for GC/MS.

C₈-C₄₀ Table						
PARAMETER	RESULT	QC	UNITS	MDL	PQL	METHOD
Percent Solids	N/A		%	0.1	0.3	EPA 160.3
FL-PRO (Petroleum Residual Organic Totals) Soil Dilution Factor = 1						
TOTAL PRO (C8-C40)	110		mg/Kg	0.01	0.03	FL-PRO

QC=Qualifier Code as defined by DEP 62-160; U=Undetected; I=In between the MDL and PQL; Q= Out of hold; MDL=Minimum Detection Limit; PQL=Practical Quantation Limit.

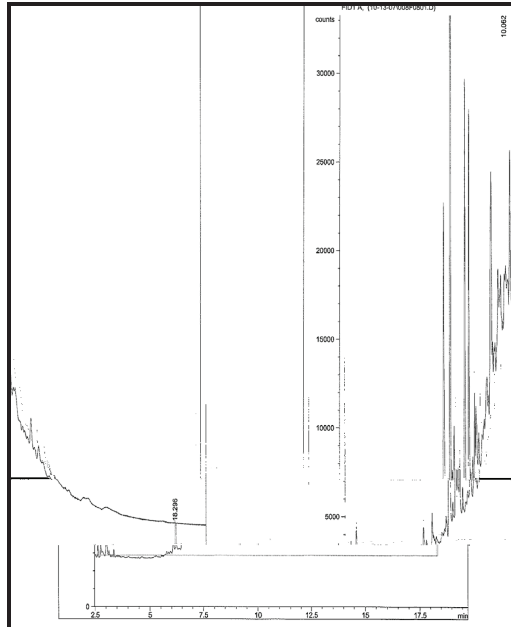

Chromatogram for sediment core BP-45 (266-272 cm).

NO PETROLEUM HYDROCARBON SPECTIATION ANALYSIS

BLIND PASS SEDIMENT CORE BP-86 (246-249 cm)



Red circle indicates area sampled for GC/MS.

C₈-C₄₀ Table						
PARAMETER	RESULT	QC	UNITS	MDL	PQL	METHOD
Percent Solids	68.3		%	0.1	0.3	EPA 160.3
FL-PRO (Petroleum Residual Organic Totals) Soil Dilution Factor = 1						
TOTAL PRO (C8-C40)	21.2		mg/Kg	0.01	0.03	FL-PRO

QC=Qualifier Code as defined by DEP 62-160; U=Undetected; I=In between the MDL and PQL; Q= Out of hold; MDL=Minimum Detection Limit; PQL=Practical Quantation Limit.

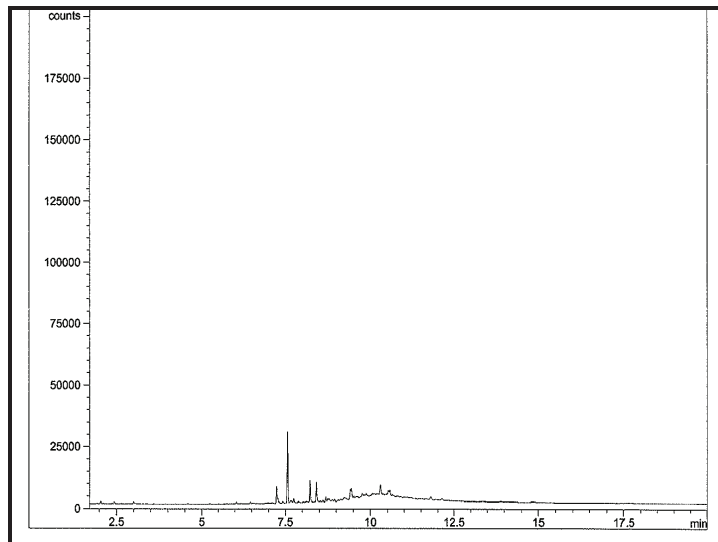

Chromatogram for sediment core BP-86 (246-249 cm).

NO PETROLEUM HYDROCARBON SPECTIATION ANALYSIS

BLIND PASS SEDIMENT CORE BP-59 (186-191 cm)

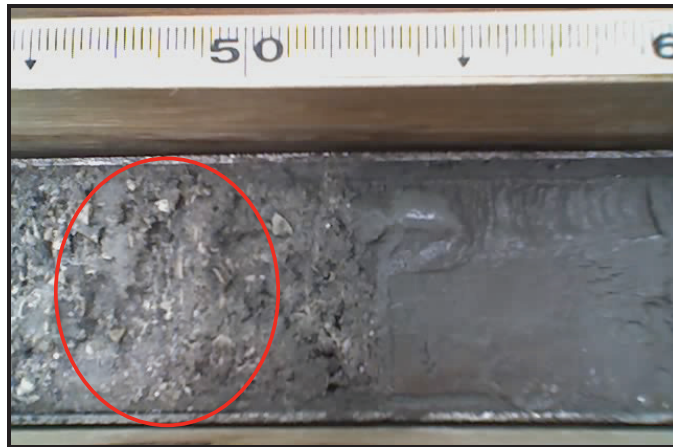

Red circle indicates area sampled for GC/MS.

C₈-C₄₀ Table						
PARAMETER	RESULT	QC	UNITS	MDL	PQL	METHOD
Percent Solids	81.3		%	0.1	0.3	EPA 160.3
FL-PRO (Petroleum Residual Organic Totals) Soil Dilution Factor = 1						
TOTAL PRO (C8-C40)	2.74	Q	mg/Kg	0.01	0.03	FL-PRO

QC=Qualifier Code as defined by DEP 62-160; U=Undetected; I=In between the MDL and PQL; Q= Out of hold; MDL=Minimum Detection Limit; PQL=Practical Quantation Limit.

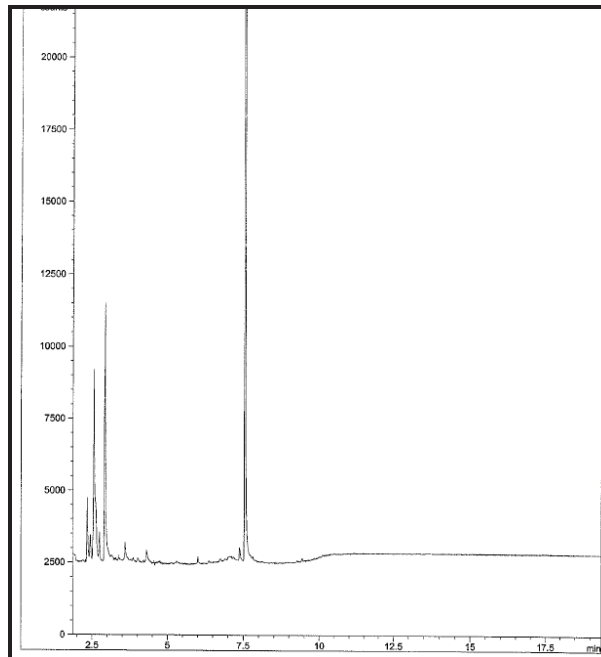

Chromatogram for sediment core BP-59 (186-191 cm).

Petroleum Hydrocarbon Speciation Analysis						
PARAMETER	RESULT	QC	UNITS	MDL	PQL	METHOD
Percent Solids	81.3		%	0.1	0.3	EPA 160.3
8260B VOA Compounds in Solids & Wastes GC/MS Dilution Factor = 1						
Methyl-tert-butyl-ether	2.13	Q	µg/Kg	0.7	2.1	5035/8260B
Methyl Ether Ketone	4.45	Q	µg/Kg	1.0	3.1	5035/8260B
Benzene	U	U	µg/Kg	0.5	1.6	5035/8260B
Toluene	U	U	µg/Kg	0.5	1.5	5035/8260B
Chlorobenzene	U	U	µg/Kg	0.7	2.1	5035/8260B
Ethylbenzene	U	U	µg/Kg	0.7	2.1	5035/8260B
M & p Xylene	U	U	µg/Kg	1.5	4.5	5035/8260B
o-Xylene	U	U	µg/Kg	0.7	2.1	5035/8260B
1,3-Dichlorobenzene	U	U	µg/Kg	1.0	3.0	5035/8260B
1,4-Dichlorobenzene	U	U	µg/Kg	0.8	2.4	5035/8260B
1,2-Dichlorobenzene	U	U	µg/Kg	0.7	2.1	5035/8260B
8270C Semivolatile Organics in Solids by GC/MS Dilution Factor = 1						
N-Nitrosodimethylamine	U	U	µg/Kg	69	207	3550/8270C
Phenol	U	U	µg/Kg	43	129	3550/8270C
2-Methyl Phenol (o-cresol)	U	U	µg/Kg	62	186	3550/8270C
3-Methyl Phenol (m-cresol)	U	U	µg/Kg	46	138	3550/8270C
4-Methyl Phenol (p-cresol)	U	U	µg/Kg	37	111	3550/8270C
Bis (2-Chloroethyl) Ether	U	U	µg/Kg	47	141	3550/8270C
2-Chlorophenol	U	U	µg/Kg	27.0	81.0	3550/8270C
1,3-Dichlorobenzene	U	U	µg/Kg	3.2	9.6	3550/8270C
1,4-Dichlorobenzene	U	U	µg/Kg	2.0	6.0	3550/8270C
Benzyl Alcohol	U	U	µg/Kg	3	9	3550/8270C
1,2-Dichlorobenzene	U	U	µg/Kg	3.5	10.5	3550/8270C
Bis (2-Chloroisopropyl) Ether	U	U	µg/Kg	47	141	3550/8270C
N-Nitrosodi-N-Propylamine	U	U	µg/Kg	24.0	72.0	3550/8270C
Hexachloroethane	U	U	µg/Kg	67	201	3550/8270C
Nitrobenzene	U	U	µg/Kg	38	114	3550/8270C
Isophorone	U	U	µg/Kg	76	228	3550/8270C
2-Nitrophenol	U	U	µg/Kg	78	234	3550/8270C
2,4-Dimethylphenol	U	U	µg/Kg	72	216	3550/8270C
Bis (2-Chloroethoxy)methane	U	U	µg/Kg	81	243	3550/8270C
2,4-Dichlorophenol	U	U	µg/Kg	59	177	3550/8270C
1,2,3-Trichlorobenzene	U	U	µg/Kg	32	96	3550/8270C
1,2,4-Trichlorobenzene	U	U	µg/Kg	42	126	3550/8270C
Naphthalene	U	U	µg/Kg	1	3	3550/8270C
Hexachlorobutadiene	U	U	µg/Kg	14	42	3550/8270C
4-Chloro-3-Methylphenol	U	U	µg/Kg	66	198	3550/8270C
1-Methylnaphthalene	U	U	µg/Kg	1	3	3550/8270C
2-Methylnaphthlene	U	U	µg/Kg	1	3	3550/8270C
Hexachlorocyclopentadiene	U	U	µg/Kg	41	123	3550/8270C
2,3,6-Trichlorophenol	U	U	µg/Kg	98	294	3550/8270C
2,4,5-Trichlorophenol	U	U	µg/Kg	60	180	3550/8270C
2,4,6-Trichlorophenol	U	U	µg/Kg	53	159	3550/8270C
2-Chloronaphthalene	U	U	µg/Kg	34	102	3550/8270C
Dimethyl Phthalate	U	U	µg/Kg	38	114	3550/8270C
Acenaphthylene	U	U	µg/Kg	2.0	6.0	3550/8270C
2,6-Dinitrotoluene	U	U	µg/Kg	26	78	3550/8270C
Acenaphthene	U	U	µg/Kg	1.3	3.9	3550/8270C

Petroleum Hydrocarbon Speciation Analysis (continued)						
PARAMETER	RESULT	QC	UNITS	MDL	PQL	METHOD
2,4-Dinitrotoluene	U	U	µg/Kg	41	123	3550/8270C
4-Nitrophenol	U	U	µg/Kg	37	111	3550/8270C
Diethyl Phthalate	U	U	µg/Kg	35	105	3550/8270C
Fluorene	U	U	µg/Kg	1.0	3.0	3550/8270C
4-Chlorophenyl Phenyl Ether	U	U	µg/Kg	45	135	3550/8270C
4,6-Dinitro-2-Methylphenol	U	U	µg/Kg	36	108	3550/8270C
N-Nitrosodiphenylamine	U	U	µg/Kg	51	153	3550/8270C
4-Bromophenyl Phenyl Ether	U	U	µg/Kg	38	114	3550/8270C
Hexachlorobenzene	U	U	µg/Kg	36	108	3550/8270C
Pentachlorophenol	U	U	µg/Kg	1.7	5.1	3550/8270C
Phenanthrene	U	U	µg/Kg	2	6	3550/8270C
Anthracene	U	U	µg/Kg	0.6	1.8	3550/8270C
Di-N-Butyl Phthalate	U	U	µg/Kg	34	102	3550/8270C
Fluoranthene	U	U	µg/Kg	1.6	4.8	3550/8270C
Benzidine	U	U	µg/Kg	33	99	3550/8270C
Pyrene	U	U	µg/Kg	2	6	3550/8270C
Butyl Benzyl Phthalate	U	U	µg/Kg	50	150	3550/8270C
Benzo(A)Anthracene	U	U	µg/Kg	1	3	3550/8270C
3,3-Dichlorobenzidine	U	U	µg/Kg	100	300	3550/8270C
Chrysene	U	U	µg/Kg	1	3	3550/8270C
Bis (2 Ethylhexyl) Phthalate	U	U	µg/Kg	39	117	3550/8270C
Di-N-Octyl Phthalate	U	U	µg/Kg	44	132	3550/8270C
Benzo(B)Fluoranthene	U	U	µg/Kg	1	3	3550/8270C
Benzo(K)Fluoranthene	U	U	µg/Kg	1	3	3550/8270C
Benzo(A)Pyrene	U	U	µg/Kg	1	3	3550/8270C
Indeno(1,2,3-CD)Pyrene	U	U	µg/Kg	2	6	3550/8270C
Dibenzo (A,H) Anthracene	U	U	µg/Kg	2	6	3550/8270C
Benzo(G,H,I)Perylene	U	U	µg/Kg	2	6	3550/8270C
Bis-2-ethylhexyl Adipate	U	U	µg/Kg	33	99	3550/8270C
Aldrin	U	U	µg/Kg	1.0	3.0	3550/8270C
-BHC	U	U	µg/Kg	3.0	9.0	3550/8270C
-BHC	U	U	µg/Kg	3.0	9.0	3550/8270C
-BHC	U	U	µg/Kg	3.0	9.0	3550/8270C
-BHC (Lindane)	U	U	µg/Kg	1.0	3.0	3550/8270C
Clordane	U	U	µg/Kg	1.0	3.0	3550/8270C
4,4'-DDD	U	U	µg/Kg	2	6	3550/8270C
4,4'-DDE	U	U	µg/Kg	1.39	4017	3550/8270C
4,4'-DDT	U	U	µg/Kg	1.69	5.07	3550/8270C
Dieldrin	U	U	µg/Kg	0.840	2.520	3550/8270C
Endosulfan I	U	U	µg/Kg	1.100	3.300	3550/8270C
Endosulfan II	U	U	µg/Kg	1.60	4.80	3550/8270C
Endosulfan Sulfate	U	U	µg/Kg	1.70	5.10	3550/8270C
Endrin	U	U	µg/Kg	1.800	5.400	3550/8270C
Endrin Aldehyde	U	U	µg/Kg	1.900	5.700	3550/8270C
Heptachlor	U	U	µg/Kg	1.78	5.34	3550/8270C
Heptachlor Epoxide	U	U	µg/Kg	1.68	5.04	3550/8270C
Toxaphene	U	U	µg/Kg	1.90	5.70	3550/8270C
PCB-1016	U	U	µg/Kg	0.30	0.90	3550/8270C
PCB-1221	U	U	µg/Kg	0.30	0.90	3550/8270C
PCB-1232	U	U	µg/Kg	0.30	0.90	3550/8270C

Petroleum Hydrocarbon Speciation Analysis (continued)						
PARAMETER	RESULT	QC	UNITS	MDL	PQL	METHOD
PCB-1242	U	U	µg/Kg	0.30	0.90	3550/8270C
PCB-1248	U	U	µg/Kg	0.30	0.90	3550/8270C
PCB-1254	U	U	µg/Kg	0.30	0.90	3550/8270C
PCB-1260	U	U	µg/Kg	0.30	0.90	3550/8270C
Dioxin	U	U	µg/Kg	30	90	3550/8270C
Azobenzene	U	U	µg/Kg	30	90	3550/8270C
Methoxychlor	U	U	µg/Kg	19	57	3550/8270C
Benzoic Acid	U	U	µg/Kg	30	90	3550/8270C
Aniline	U	U	µg/Kg	30	90	3550/8270C
4-Chloroaniline	U	U	µg/Kg	11	33	3550/8270C
Dibenzofuran	U	U	µg/Kg	30	90	3550/8270C
2-Nitroaniline	U	U	µg/Kg	37	111	3550/8270C
30Nitroaniline	U	U	µg/Kg	30	90	3550/8270C
4-Nitroaniline	U	U	µg/Kg	30	90	3550/8270C
Carbazole	U	U	µg/Kg	30	90	3550/8270C
2,6-Dichlorophenol	U	U	µg/Kg	17	51	3550/8270C
2,3,4,6-Tetrachlorophenol	U	U	µg/Kg	30	90	3550/8270C
2,3,5,6-Tetrachlorophenol	U	U	µg/Kg	30	90	3550/8270C
Pyridine	U	U	µg/Kg	67	201	3550/8270C
FL-PRO (Petroleum Residual Organic Totals) Soil Dilution Factor = 1						
TOTAL PRO (C8-C40)	2.74		mg/Kg	0.01	0.03	FL-PRO
TPHCWG TPH-CWG Speciation Method (Soils) Dilution Factor = 1						
C5-C7 Aromatics	U	U	µg/Kg	5.0	15.0	TPHCWG
C7-C8 Aromatics	U	U	µg/Kg	5.0	15.0	TPHCWG
C8-C10 Aromatics	U	U	µg/Kg	5.0	15.0	TPHCWG
C10-C12 Aromatics	U	U	µg/Kg	5.0	15.0	TPHCWG
C12-C16 Aromatics	U	U	µg/Kg	5.0	15.0	TPHCWG
C16-C21 Aromatics	U	U	µg/Kg	5.0	15.0	TPHCWG
C21-C35 Aromatics	U	U	µg/Kg	5.0	15.0	TPHCWG
C5-C6 Aliphatics	U	U	µg/Kg	5.0	15.0	TPHCWG
C6-C8 Aliphatics	U	U	µg/Kg	5.0	15.0	TPHCWG
C8-C10 Aliphatics	U	U	µg/Kg	5.0	15.0	TPHCWG
C10-C12 Aliphatics	U	U	µg/Kg	5.0	15.0	TPHCWG
C12-C16 Aliphatics	U	U	µg/Kg	5.0	15.0	TPHCWG
C16-C35 Aliphatics	U	U	µg/Kg	5.0	15.0	TPHCWG

QC=Qualifier Code as defined by DEP 62-160; U=Undetected; MDL=Minimum Detection Limit; PQL=Practical Quantation Limit.

BLIND PASS SEDIMENT CORE BP-76 (224-229 cm)

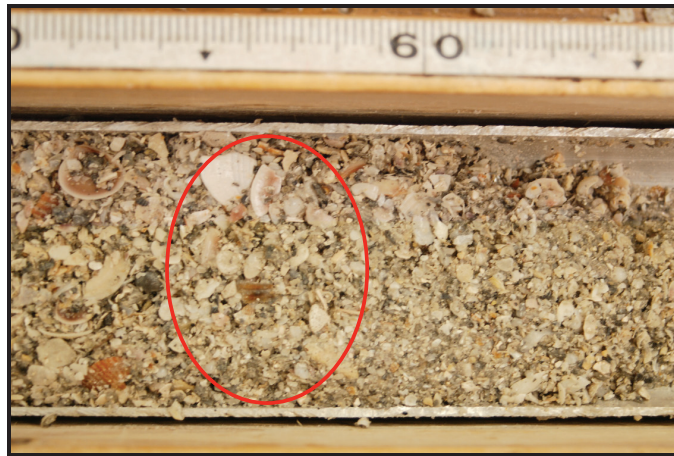

Red circle indicates area sampled for GC/MS analysis.

C₈-C₄₀ Table						
PARAMETER	RESULT	QC	UNITS	MDL	PQL	METHOD
Percent Solids	92.6		%	0.1	0.3	EPA 160.3
FL-PRO (Petroleum Residual Organic Totals) Soil Dilution Factor = 1						
TOTAL PRO (C8-C40)	7.01	U	mg/Kg	0.01	0.03	FL-PRO

QC=Qualifier Code as defined by DEP 62-160; U=Undetected; I=In between the MDL and PQL; Q= Out of hold; MDL=Minimum Detection Limit; PQL=Practical Quantation Limit.

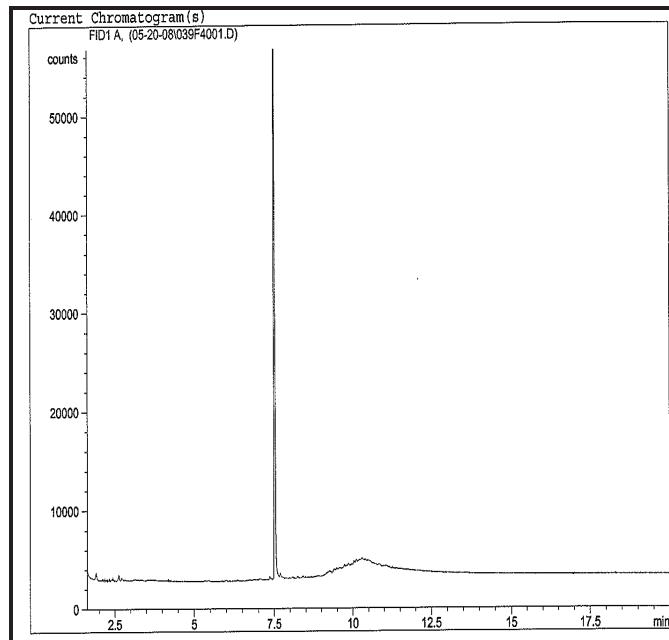

Chromatogram for sediment core BP-76 (224-229 cm).

Petroleum Hydrocarbon Speciation Analysis						
PARAMETER	RESULT	QC	UNITS	MDL	PQL	METHOD
Percent Solids	92.6		%	0.1	0.3	EPA 160.3
8260B VOA Compounds in Solids & Wastes GC/MS Dilution Factor = 1						
Methyl-tert-butyl-ether	U	U	µg/Kg	1.9	5.7	5030/8260B
Benzene	U	U	µg/Kg	0.85	2.55	5030/8260B
Toluene	U	U	µg/Kg	1.4	4.2	5030/8260B
Chlorobenzene	U	U	µg/Kg	2.3	6.9	5030/8260B
Ethylbenzene	U	U	µg/Kg	1.5	4.5	5030/8260B
M & p Xylene	U	U	µg/Kg	1.3	3.9	5030/8260B
o-Xylene	U	U	µg/Kg	1.1	3.3	5030/8260B
1,3-Dichlorobenzene	U	U	µg/Kg	3.2	9.6	5030/8260B
1,4-Dichlorobenzene	U	U	µg/Kg	2.0	6.0	5030/8260B
1,2-Dichlorobenzene	U	U	µg/Kg	3.5	10.5	5030/8260B
8270C Semivolatile Organics in Solids by GC/MS Dilution Factor = 1						
N-Nitrosodimethylamine	U	U	µg/Kg	69	207	3550/8270C
Phenol	U	U	µg/Kg	43	129	3550/8270C
2-Methyl Phenol (o-cresol)	U	U	µg/Kg	62	186	3550/8270C
3-Methyl Phenol (m-cresol)	U	U	µg/Kg	46	138	3550/8270C
4-Methyl Phenol (p-cresol)	U	U	µg/Kg	37	111	3550/8270C
Bis (2-Chloroethyl) Ether	U	U	µg/Kg	47	141	3550/8270C
2-Chlorophenol	U	U	µg/Kg	27.0	81.0	3550/8270C
1,3-Dichlorobenzene	U	U	µg/Kg	3.2	9.6	3550/8270C
1,4-Dichlorobenzene	U	U	µg/Kg	2.0	6.0	3550/8270C
Benzyl Alcohol	U	U	µg/Kg	3	9	3550/8270C
1,2-Dichlorobenzene	U	U	µg/Kg	3.5	10.5	3550/8270C
Bis (2-Chloroisopropyl) Ether	U	U	µg/Kg	47	141	3550/8270C
N-Nitrosodi-N-Proplamine	U	U	µg/Kg	24.0	72.0	3550/8270C
Hexachloroethane	U	U	µg/Kg	67	201	3550/8270C
Nitrobenzene	U	U	µg/Kg	38	114	3550/8270C
Isophorone	U	U	µg/Kg	76	228	3550/8270C
2-Nitrophenol	U	U	µg/Kg	78	234	3550/8270C
2,4-Dimethylphenol	U	U	µg/Kg	72	216	3550/8270C
Bis (2-Chloroethoxy)methane	U	U	µg/Kg	81	243	3550/8270C
2,4-Dichlorophenol	U	U	µg/Kg	59	177	3550/8270C
1,2,3-Trichlorobenzene	U	U	µg/Kg	32	96	3550/8270C
1,2,4-Trichlorobenzene	U	U	µg/Kg	42	126	3550/8270C
Naphthalene	U	U	µg/Kg	1	3	3550/8270C
Hexachlorobutadiene	U	U	µg/Kg	14	42	3550/8270C
4-Chloro-3-Methylphenol	U	U	µg/Kg	66	198	3550/8270C
1-Methylnaphthalene	U	U	µg/Kg	1	3	3550/8270C
2-Methylnaphthlene	U	U	µg/Kg	1	3	3550/8270C
Hexachlorocyclopentadiene	U	U	µg/Kg	41	123	3550/8270C
2,3,6-Trichlorophenol	U	U	µg/Kg	98	294	3550/8270C
2,4,5-Trichlorophenol	U	U	µg/Kg	60	180	3550/8270C
2,4,6-Trichlorophenol	U	U	µg/Kg	53	159	3550/8270C
2-Chloronaphthalene	U	U	µg/Kg	34	102	3550/8270C
Dimethyl Phthalate	U	U	µg/Kg	38	114	3550/8270C
Acenaphthylene	U	U	µg/Kg	2.0	6.0	3550/8270C
2,6-Dinitrotoluene	U	U	µg/Kg	26	78	3550/8270C
Acenaphthene	U	U	µg/Kg	1.3	3.9	3550/8270C
2,4-Dinitrophenol	U	U	µg/Kg	34	102	3550/8270C

Petroleum Hydrocarbon Speciation Analysis (continued)						
PARAMETER	RESULT	QC	UNITS	MDL	PQL	METHOD
2,4-Dinitrotoluene	U	U	µg/Kg	41	123	3550/8270C
4-Nitrophenol	U	U	µg/Kg	37	111	3550/8270C
Diethyl Phthalate	U	U	µg/Kg	35	105	3550/8270C
Fluorene	U	U	µg/Kg	1.0	3.0	3550/8270C
4-Chlorophenyl Phenyl Ether	U	U	µg/Kg	45	135	3550/8270C
4,6-Dinitro-2-Methylphenol	U	U	µg/Kg	36	108	3550/8270C
N-Nitrosodiphenylamine	U	U	µg/Kg	51	153	3550/8270C
4-Bromophenyl Phenyl Ether	U	U	µg/Kg	38	114	3550/8270C
Hexachlorobenzene	U	U	µg/Kg	36	108	3550/8270C
Pentachlorophenol	U	U	µg/Kg	1.7	5.1	3550/8270C
Phenanthrene	U	U	µg/Kg	2	6	3550/8270C
Anthracene	U	U	µg/Kg	0.6	1.8	3550/8270C
Di-N-Butyl Phthalate	U	U	µg/Kg	34	102	3550/8270C
Fluoranthene	7.03		µg/Kg	1.6	4.8	3550/8270C
Benzidine	U	U	µg/Kg	33	99	3550/8270C
Pyrene	16.3		µg/Kg	2	6	3550/8270C
Butyl Benzyl Phthalate	U	U	µg/Kg	50	150	3550/8270C
Benzo(A)Anthracene	7.34		µg/Kg	1	3	3550/8270C
3,3-Dichlorobenzidine	U	U	µg/Kg	100	300	3550/8270C
Chrysene	8.40		µg/Kg	1	3	3550/8270C
Bis (2 Ethylhexyl) Phthalate	U	U	µg/Kg	39	117	3550/8270C
Di-N-Octyl Phthalate	U	U	µg/Kg	44	132	3550/8270C
Benzo(B)Fluoranthene	13.2		µg/Kg	1	3	3550/8270C
Benzo(K)Fluoranthene	4.70		µg/Kg	1	3	3550/8270C
Benzo(A)Pyrene	14.0		µg/Kg	1	3	3550/8270C
Indeno(1,2,3-CD)Pyrene	U	U	µg/Kg	2	6	3550/8270C
Dibenzo (A,H) Anthracene	1.72		µg/Kg	2	6	3550/8270C
Benzo(G,H,I)Perylene	1.96		µg/Kg	2	6	3550/8270C
Bis-2-ethylexyl Adipate	U	U	µg/Kg	33	99	3550/8270C
Aldrin	U	U	µg/Kg	1.0	3.0	3550/8270C
-BHC	U	U	µg/Kg	3.0	9.0	3550/8270C
-BHC	U	U	µg/Kg	3.0	9.0	3550/8270C
-BHC	U	U	µg/Kg	3.0	9.0	3550/8270C
-BHC (Lindane)	U	U	µg/Kg	1.0	3.0	3550/8270C
Clordane	U	U	µg/Kg	1.0	3.0	3550/8270C
4,4'-DDD	U	U	µg/Kg	2	6	3550/8270C
4,4'-DDE	U	U	µg/Kg	1.39	4017	3550/8270C
4,4'-DDT	U	U	µg/Kg	1.69	5.07	3550/8270C
Dieldrin	U	U	µg/Kg	0.840	2.520	3550/8270C
Endosulfan I	U	U	µg/Kg	1.100	3.300	3550/8270C
Endosulfan II	U	U	µg/Kg	1.60	4.80	3550/8270C
Endosulfan Sulfate	U	U	µg/Kg	1.70	5.10	3550/8270C
Endrin	U	U	µg/Kg	1.800	5.400	3550/8270C
Endrin Aldehyde	U	U	µg/Kg	1.900	5.700	3550/8270C
Heptachlor	U	U	µg/Kg	1.78	5.34	3550/8270C
Heptachlor Epoxide	U	U	µg/Kg	1.68	5.04	3550/8270C
Toxaphene	U	U	µg/Kg	1.90	5.70	3550/8270C
PCB-1016	U	U	µg/Kg	0.30	0.90	3550/8270C
PCB-1221	U	U	µg/Kg	0.30	0.90	3550/8270C
PCB-1232	U	U	µg/Kg	0.30	0.90	3550/8270C
PCB-1242	U	U	µg/Kg	0.30	0.90	3550/8270C

Petroleum Hydrocarbon Speciation Analysis (continued)						
PARAMETER	RESULT	QC	UNITS	MDL	PQL	METHOD
PCB-1248	U	U	µg/Kg	0.30	0.90	3550/8270C
PCB-1254	U	U	µg/Kg	0.30	0.90	3550/8270C
PCB-1260	U	U	µg/Kg	0.30	0.90	3550/8270C
Dioxin	U	U	µg/Kg	30	90	3550/8270C
Azobenzene	U	U	µg/Kg	30	90	3550/8270C
Methoxychlor	U	U	µg/Kg	19	57	3550/8270C
Benzoic Acid	U	U	µg/Kg	30	90	3550/8270C
Aniline	U	U	µg/Kg	30	90	3550/8270C
4-Chloroaniline	U	U	µg/Kg	11	33	3550/8270C
Dibenzofuran	U	U	µg/Kg	30	90	3550/8270C
2-Nitroaniline	U	U	µg/Kg	37	111	3550/8270C
30Nitroaniline	U	U	µg/Kg	30	90	3550/8270C
4-Nitroaniline	U	U	µg/Kg	30	90	3550/8270C
Carbazole	U	U	µg/Kg	30	90	3550/8270C
2,6-Dichlorophenol	U	U	µg/Kg	17	51	3550/8270C
2,3,4,6-Tetrachlorophenol	U	U	µg/Kg	30	90	3550/8270C
2,3,5,6-Tetrachlorophenol	U	U	µg/Kg	30	90	3550/8270C
Pyridine	U	U	µg/Kg	67	201	3550/8270C
FL-PRO (Petroleum Residual Organic Totals) Soil Dilution Factor = 1						
TOTAL PRO (C8-C40)	7.01		mg/Kg	0.01	0.03	FL-PRO
TPHCWG TPH-CWG Speciation Method (Soils) Dilution Factor = 1						
C5-C7 Aromatics	U	U	µg/Kg	5.0	15.0	TPHCWG
C7-C8 Aromatics	U	U	µg/Kg	5.0	15.0	TPHCWG
C8-C10 Aromatics	U	U	µg/Kg	5.0	15.0	TPHCWG
C10-C12 Aromatics	U	U	µg/Kg	5.0	15.0	TPHCWG
C12-C16 Aromatics	U	U	µg/Kg	5.0	15.0	TPHCWG
C16-C21 Aromatics	72.6		µg/Kg	5.0	15.0	TPHCWG
C21-C35 Aromatics	5.26		µg/Kg	5.0	15.0	TPHCWG
C5-C6 Aliphatics	U	U	µg/Kg	5.0	15.0	TPHCWG
C6-C8 Aliphatics	U	U	µg/Kg	5.0	15.0	TPHCWG
C8-C10 Aliphatics	U	U	µg/Kg	5.0	15.0	TPHCWG
C10-C12 Aliphatics	U	U	µg/Kg	5.0	15.0	TPHCWG
C12-C16 Aliphatics	U	U	µg/Kg	5.0	15.0	TPHCWG
C16-C35 Aliphatics	7010		µg/Kg	5.0	15.0	TPHCWG

QC=Qualifier Code as defined by DEP 62-160; U=Undetected; MDL=Minimum Detection Limit; PQL=Practical Quantization Limit.

BLIND PASS SEDIMENT CORE BP-76 (78-81 cm)



Red circle indicates area sampled for GC/MS.

C₈-C₄₀ Table						
PARAMETER	RESULT	QC	UNITS	MDL	PQL	METHOD
Percent Solids	87.7		%	0.1	0.3	EPA 160.3
FL-PRO (Petroleum Residual Organic Totals) Soil Dilution Factor = 1						
TOTAL PRO (C8-C40)	1.61	Q	mg/Kg	0.01	0.03	FL-PRO

QC=Qualifier Code as defined by DEP 62-160; U=Undetected; I=In between the MDL and PQL; Q= Out of hold; MDL=Minimum Detection Limit; PQL=Practical Quantation Limit.

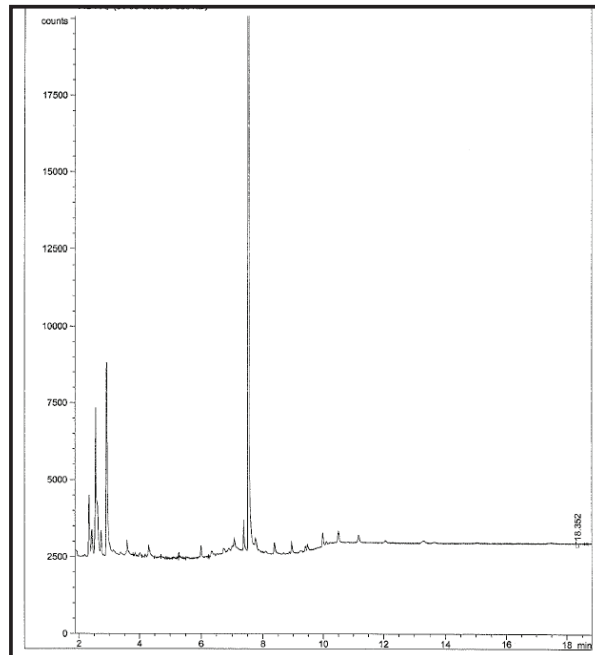

Chromatogram for sediment core BP-76 (78-81 cm).

Petroleum Hydrocarbon Speciation Analysis						
PARAMETER	RESULT	QC	UNITS	MDL	PQL	METHOD
Percent Solids	87.7		%	0.1	0.3	EPA 160.3
8260B VOA Compounds in Solids & Wastes GC/MS Dilution Factor = 1						
Methyl-tert-butyl-ether	1.94	Q	µg/Kg	0.7	2.1	5035/8260B
Methyl Ether Ketone	U	U	µg/Kg	1.0	3.1	5035/8260B
Benzene	U	U	µg/Kg	0.5	1.6	5035/8260B
Toluene	U	U	µg/Kg	0.5	1.5	5035/8260B
Chlorobenzene	U	U	µg/Kg	0.7	2.1	5035/8260B
Ethylbenzene	U	U	µg/Kg	0.7	2.1	5035/8260B
M & p Xylene	U	U	µg/Kg	1.5	4.5	5035/8260B
o-Xylene	U	U	µg/Kg	0.7	2.1	5035/8260B
1,3-Dichlorobenzene	U	U	µg/Kg	1.0	3.0	5035/8260B
1,4-Dichlorobenzene	U	U	µg/Kg	0.8	2.4	5035/8260B
1,2-Dichlorobenzene	U	U	µg/Kg	0.7	2.1	5035/8260B
8270C Semivolatile Organics in Solids by GC/MS Dilution Factor = 1						
N-Nitrosodimethylamine	U	U	µg/Kg	69	207	3550/8270C
Phenol	U	U	µg/Kg	43	129	3550/8270C
2-Methyl Phenol (o-cresol)	U	U	µg/Kg	62	186	3550/8270C
3-Methyl Phenol (m-cresol)	U	U	µg/Kg	46	138	3550/8270C
4-Methyl Phenol (p-cresol)	U	U	µg/Kg	37	111	3550/8270C
Bis (2-Chloroethyl) Ether	U	U	µg/Kg	47	141	3550/8270C
2-Chlorophenol	U	U	µg/Kg	27.0	81.0	3550/8270C
1,3-Dichlorobenzene	U	U	µg/Kg	3.2	9.6	3550/8270C
1,4-Dichlorobenzene	U	U	µg/Kg	2.0	6.0	3550/8270C
Benzyl Alcohol	U	U	µg/Kg	3	9	3550/8270C
1,2-Dichlorobenzene	U	U	µg/Kg	3.5	10.5	3550/8270C
Bis (2-Chloroisopropyl) Ether	U	U	µg/Kg	47	141	3550/8270C
N-Nitrosodi-N-Proplamine	U	U	µg/Kg	24.0	72.0	3550/8270C
Hexachloroethane	U	U	µg/Kg	67	201	3550/8270C
Nitrobenzene	U	U	µg/Kg	38	114	3550/8270C
Isophorone	U	U	µg/Kg	76	228	3550/8270C
2-Nitrophenol	U	U	µg/Kg	78	234	3550/8270C
2,4-Dimethylphenol	U	U	µg/Kg	72	216	3550/8270C
Bis (2-Chloroethoxy)methane	U	U	µg/Kg	81	243	3550/8270C
2,4-Dichlorophenol	U	U	µg/Kg	59	177	3550/8270C
1,2,3-Trichlorobenzene	U	U	µg/Kg	32	96	3550/8270C
1,2,4-Trichlorobenzene	U	U	µg/Kg	42	126	3550/8270C
Naphthalene	U	U	µg/Kg	1	3	3550/8270C
Hexachlorobutadiene	U	U	µg/Kg	14	42	3550/8270C
4-Chloro-3-Methylphenol	U	U	µg/Kg	66	198	3550/8270C
1-Methylnaphthalene	U	U	µg/Kg	1	3	3550/8270C
2-Methylnaphthlene	U	U	µg/Kg	1	3	3550/8270C
Hexachlorocyclopentadiene	U	U	µg/Kg	41	123	3550/8270C
2,3,6-Trichlorophenol	U	U	µg/Kg	98	294	3550/8270C
2,4,5-Trichlorophenol	U	U	µg/Kg	60	180	3550/8270C
2,4,6-Trichlorophenol	U	U	µg/Kg	53	159	3550/8270C
2-Chloronaphthalene	U	U	µg/Kg	34	102	3550/8270C
Dimethyl Phthalate	U	U	µg/Kg	38	114	3550/8270C
Acenaphthylene	U	U	µg/Kg	2.0	6.0	3550/8270C
2,6-Dinitrotoluene	U	U	µg/Kg	26	78	3550/8270C
Acenaphthene	U	U	µg/Kg	1.3	3.9	3550/8270C

Petroleum Hydrocarbon Speciation Analysis (continued)						
PARAMETER	RESULT	QC	UNITS	MDL	PQL	METHOD
2,4-Dinitrotoluene	U	U	µg/Kg	41	123	3550/8270C
4-Nitrophenol	U	U	µg/Kg	37	111	3550/8270C
Diethyl Phthalate	U	U	µg/Kg	35	105	3550/8270C
Fluorene	U	U	µg/Kg	1.0	3.0	3550/8270C
4-Chlorophenyl Phenyl Ether	U	U	µg/Kg	45	135	3550/8270C
4,6-Dinitro-2-Methylphenol	U	U	µg/Kg	36	108	3550/8270C
N-Nitrosodiphenylamine	U	U	µg/Kg	51	153	3550/8270C
4-Bromophenyl Phenyl Ether	U	U	µg/Kg	38	114	3550/8270C
Hexachlorobenzene	U	U	µg/Kg	36	108	3550/8270C
Pentachlorophenol	U	U	µg/Kg	1.7	5.1	3550/8270C
Phenanthrene	U	U	µg/Kg	2	6	3550/8270C
Anthracene	U	U	µg/Kg	0.6	1.8	3550/8270C
Di-N-Butyl Phthalate	U	U	µg/Kg	34	102	3550/8270C
Fluoranthene	U	U	µg/Kg	1.6	4.8	3550/8270C
Benzidine	U	U	µg/Kg	33	99	3550/8270C
Pyrene	U	U	µg/Kg	2	6	3550/8270C
Butyl Benzyl Phthalate	U	U	µg/Kg	50	150	3550/8270C
Benzo(A)Anthracene	U	U	µg/Kg	1	3	3550/8270C
3,3-Dichlorobenzidine	U	U	µg/Kg	100	300	3550/8270C
Chrysene	U	U	µg/Kg	1	3	3550/8270C
Bis (2 Ethylhexyl) Phthalate	U	U	µg/Kg	39	117	3550/8270C
Di-N-Octyl Phthalate	U	U	µg/Kg	44	132	3550/8270C
Benzo(B)Fluoranthene	U	U	µg/Kg	1	3	3550/8270C
Benzo(K)Fluoranthene	U	U	µg/Kg	1	3	3550/8270C
Benzo(A)Pyrene	U	U	µg/Kg	1	3	3550/8270C
Indeno(1,2,3-CD)Pyrene	U	U	µg/Kg	2	6	3550/8270C
Dibenzo (A,H) Anthracene	U	U	µg/Kg	2	6	3550/8270C
Benzo(G,H,I)Perylene	U	U	µg/Kg	2	6	3550/8270C
Bis-2-ethylhexyl Adipate	U	U	µg/Kg	33	99	3550/8270C
Aldrin	U	U	µg/Kg	1.0	3.0	3550/8270C
-BHC	U	U	µg/Kg	3.0	9.0	3550/8270C
-BHC	U	U	µg/Kg	3.0	9.0	3550/8270C
-BHC	U	U	µg/Kg	3.0	9.0	3550/8270C
-BHC (Lindane)	U	U	µg/Kg	1.0	3.0	3550/8270C
Clordane	U	U	µg/Kg	1.0	3.0	3550/8270C
4,4'-DDD	U	U	µg/Kg	2	6	3550/8270C
4,4'-DDE	U	U	µg/Kg	1.39	4017	3550/8270C
4,4'-DDT	U	U	µg/Kg	1.69	5.07	3550/8270C
Dieldrin	U	U	µg/Kg	0.840	2.520	3550/8270C
Endosulfan I	U	U	µg/Kg	1.100	3.300	3550/8270C
Endosulfan II	U	U	µg/Kg	1.60	4.80	3550/8270C
Endosulfan Sulfate	U	U	µg/Kg	1.70	5.10	3550/8270C
Endrin	U	U	µg/Kg	1.800	5.400	3550/8270C
Endrin Aldehyde	U	U	µg/Kg	1.900	5.700	3550/8270C
Heptachlor	U	U	µg/Kg	1.78	5.34	3550/8270C
Heptachlor Epoxide	U	U	µg/Kg	1.68	5.04	3550/8270C
Toxaphene	U	U	µg/Kg	1.90	5.70	3550/8270C
PCB-1016	U	U	µg/Kg	0.30	0.90	3550/8270C
PCB-1221	U	U	µg/Kg	0.30	0.90	3550/8270C
PCB-1232	U	U	µg/Kg	0.30	0.90	3550/8270C

Petroleum Hydrocarbon Speciation Analysis (continued)						
PARAMETER	RESULT	QC	UNITS	MDL	PQL	METHOD
PCB-1242	U	U	µg/Kg	0.30	0.90	3550/8270C
PCB-1248	U	U	µg/Kg	0.30	0.90	3550/8270C
PCB-1254	U	U	µg/Kg	0.30	0.90	3550/8270C
PCB-1260	U	U	µg/Kg	0.30	0.90	3550/8270C
Dioxin	U	U	µg/Kg	30	90	3550/8270C
Azobenzene	U	U	µg/Kg	30	90	3550/8270C
Methoxychlor	U	U	µg/Kg	19	57	3550/8270C
Benzoic Acid	U	U	µg/Kg	30	90	3550/8270C
Aniline	U	U	µg/Kg	30	90	3550/8270C
4-Chloroaniline	U	U	µg/Kg	11	33	3550/8270C
Dibenzofuran	U	U	µg/Kg	30	90	3550/8270C
2-Nitroaniline	U	U	µg/Kg	37	111	3550/8270C
30Nitroaniline	U	U	µg/Kg	30	90	3550/8270C
4-Nitroaniline	U	U	µg/Kg	30	90	3550/8270C
Carbazole	U	U	µg/Kg	30	90	3550/8270C
2,6-Dichlorophenol	U	U	µg/Kg	17	51	3550/8270C
2,3,4,6-Tetrachlorophenol	U	U	µg/Kg	30	90	3550/8270C
2,3,5,6-Tetrachlorophenol	U	U	µg/Kg	30	90	3550/8270C
Pyridine	U	U	µg/Kg	67	201	3550/8270C
FL-PRO (Petroleum Residual Organic Totals) Soil Dilution Factor = 1						

BLIND PASS SEDIMENT CORE BP-82 (36-40 cm)

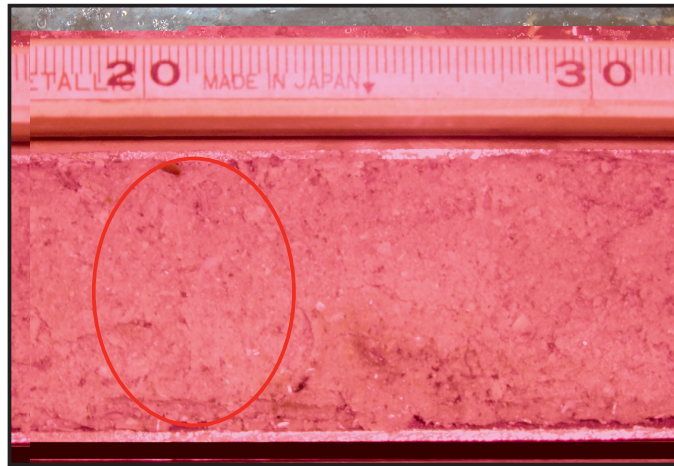

Red circle indicates area sampled for GC/MS.

C₈-C₄₀ Table						
PARAMETER	RESULT	QC	UNITS	MDL	PQL	METHOD
Percent Solids	83.5		%	0.1	0.3	EPA 160.3
FL-PRO (Petroleum Residual Organic Totals) Soil Dilution Factor = 1						
TOTAL PRO (C8-C40)	2.18	Q	mg/Kg	0.01	0.03	FL-PRO

QC=Qualifier Code as defined by DEP 62-160; U=Undetected; I=In between the MDL and PQL; Q= Out of hold; MDL=Minimum Detection Limit; PQL=Practical Quantation Limit.

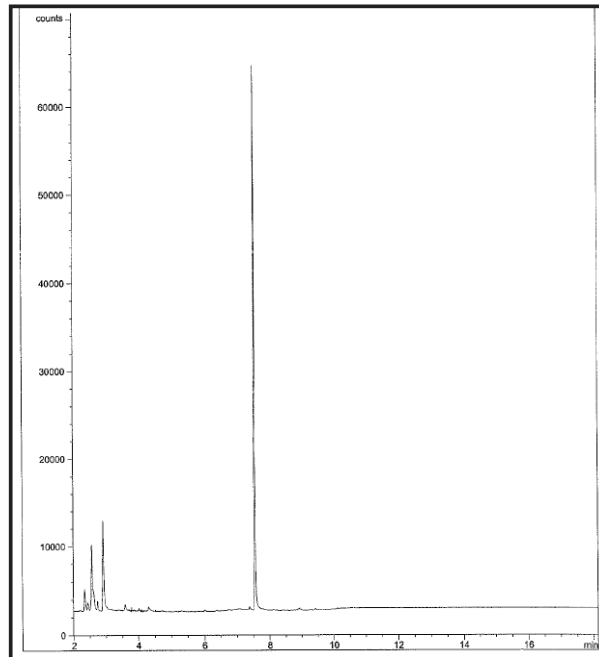

Chromatogram for sediment core BP-82 (36-40 cm).

Petroleum Hydrocarbon Speciation Analysis						
PARAMETER	RESULT	QC	UNITS	MDL	PQL	METHOD
Percent Solids	83.5		%	0.1	0.3	EPA 160.3
8260B VOA Compounds in Solids & Wastes GC/MS Dilution Factor = 1						
Methyl-tert-butyl-ether	2.59	Q	µg/Kg	0.7	2.1	5035/8260B
Methyl Ether Ketone	U	U	µg/Kg	1.0	3.1	5035/8260B
Benzene	U	U	µg/Kg	0.5	1.6	5035/8260B
Toluene	U	U	µg/Kg	0.5	1.5	5035/8260B
Chlorobenzene	U	U	µg/Kg	0.7	2.1	5035/8260B
Ethylbenzene	U	U	µg/Kg	0.7	2.1	5035/8260B
M & p Xylene	U	U	µg/Kg	1.5	4.5	5035/8260B
o-Xylene	U	U	µg/Kg	0.7	2.1	5035/8260B
1,3-Dichlorobenzene	U	U	µg/Kg	1.0	3.0	5035/8260B
1,4-Dichlorobenzene	U	U	µg/Kg	0.8	2.4	5035/8260B
1,2-Dichlorobenzene	U	U	µg/Kg	0.7	2.1	5035/8260B
8270C Semivolatile Organics in Solids by GC/MS Dilution Factor = 1						
N-Nitrosodimethylamine	U	U	µg/Kg	69	207	3550/8270C
Phenol	U	U	µg/Kg	43	129	3550/8270C
2-Methyl Phenol (o-cresol)	U	U	µg/Kg	62	186	3550/8270C
3-Methyl Phenol (m-cresol)	U	U	µg/Kg	46	138	3550/8270C
4-Methyl Phenol (p-cresol)	U	U	µg/Kg	37	111	3550/8270C
Bis (2-Chloroethyl) Ether	U	U	µg/Kg	47	141	3550/8270C
2-Chlorophenol	U	U	µg/Kg	27.0	81.0	3550/8270C
1,3-Dichlorobenzene	U	U	µg/Kg	3.2	9.6	3550/8270C
1,4-Dichlorobenzene	U	U	µg/Kg	2.0	6.0	3550/8270C
Benzyl Alcohol	U	U	µg/Kg	3	9	3550/8270C
1,2-Dichlorobenzene	U	U	µg/Kg	3.5	10.5	3550/8270C
Bis (2-Chloroisopropyl) Ether	U	U	µg/Kg	47	141	3550/8270C
N-Nitrosodi-N-Proplamine	U	U	µg/Kg	24.0	72.0	3550/8270C
Hexachloroethane	U	U	µg/Kg	67	201	3550/8270C
Nitrobenzene	U	U	µg/Kg	38	114	3550/8270C
Isophorone	U	U	µg/Kg	76	228	3550/8270C
2-Nitrophenol	U	U	µg/Kg	78	234	3550/8270C
2,4-Dimethylphenol	U	U	µg/Kg	72	216	3550/8270C
Bis (2-Chloroethoxy)methane	U	U	µg/Kg	81	243	3550/8270C
2,4-Dichlorophenol	U	U	µg/Kg	59	177	3550/8270C
1,2,3-Trichlorobenzene	U	U	µg/Kg	32	96	3550/8270C
1,2,4-Trichlorobenzene	U	U	µg/Kg	42	126	3550/8270C
Naphthalene	U	U	µg/Kg	1	3	3550/8270C
Hexachlorobutadiene	U	U	µg/Kg	14	42	3550/8270C
4-Chloro-3-Methylphenol	U	U	µg/Kg	66	198	3550/8270C
1-Methylnaphthalene	U	U	µg/Kg	1	3	3550/8270C
2-Methylnaphthlene	U	U	µg/Kg	1	3	3550/8270C
Hexachlorocyclopentadiene	U	U	µg/Kg	41	123	3550/8270C
2,3,6-Trichlorophenol	U	U	µg/Kg	98	294	3550/8270C
2,4,5-Trichlorophenol	U	U	µg/Kg	60	180	3550/8270C
2,4,6-Trichlorophenol	U	U	µg/Kg	53	159	3550/8270C
2-Chloronaphthalene	U	U	µg/Kg	34	102	3550/8270C
Dimethyl Phthalate	U	U	µg/Kg	38	114	3550/8270C
Acenaphthylene	U	U	µg/Kg	2.0	6.0	3550/8270C
2,6-Dinitrotoluene	U	U	µg/Kg	26	78	3550/8270C
Acenaphthene	U	U	µg/Kg	1.3	3.9	3550/8270C

Petroleum Hydrocarbon Speciation Analysis (continued)						
PARAMETER	RESULT	QC	UNITS	MDL	PQL	METHOD
2,4-Dinitrotoluene	U	U	µg/Kg	41	123	3550/8270C
4-Nitrophenol	U	U	µg/Kg	37	111	3550/8270C
Diethyl Phthalate	U	U	µg/Kg	35	105	3550/8270C
Fluorene	U	U	µg/Kg	1.0	3.0	3550/8270C
4-Chlorophenyl Phenyl Ether	U	U	µg/Kg	45	135	3550/8270C
4,6-Dinitro-2-Methylphenol	U	U	µg/Kg	36	108	3550/8270C
N-Nitrosodiphenylamine	U	U	µg/Kg	51	153	3550/8270C
4-Bromophenyl Phenyl Ether	U	U	µg/Kg	38	114	3550/8270C
Hexachlorobenzene	U	U	µg/Kg	36	108	3550/8270C
Pentachlorophenol	U	U	µg/Kg	1.7	5.1	3550/8270C
Phenanthrene	U	U	µg/Kg	2	6	3550/8270C
Anthracene	U	U	µg/Kg	0.6	1.8	3550/8270C
Di-N-Butyl Phthalate	U	U	µg/Kg	34	102	3550/8270C
Fluoranthene	U	U	µg/Kg	1.6	4.8	3550/8270C
Benzidine	U	U	µg/Kg	33	99	3550/8270C
Pyrene	U	U	µg/Kg	2	6	3550/8270C
Butyl Benzyl Phthalate	U	U	µg/Kg	50	150	3550/8270C
Benzo(A)Anthracene	U	U	µg/Kg	1	3	3550/8270C
3,3-Dichlorobenzidine	U	U	µg/Kg	100	300	3550/8270C
Chrysene	U	U	µg/Kg	1	3	3550/8270C
Bis (2 Ethylhexyl) Phthalate	U	U	µg/Kg	39	117	3550/8270C
Di-N-Octyl Phthalate	U	U	µg/Kg	44	132	3550/8270C
Benzo(B)Fluoranthene	U	U	µg/Kg	1	3	3550/8270C
Benzo(K)Fluoranthene	U	U	µg/Kg	1	3	3550/8270C
Benzo(A)Pyrene	U	U	µg/Kg	1	3	3550/8270C
Indeno(1,2,3-CD)Pyrene	U	U	µg/Kg	2	6	3550/8270C
Dibenzo (A,H) Anthracene	U	U	µg/Kg	2	6	3550/8270C
Benzo(G,H,I)Perylene	U	U	µg/Kg	2	6	3550/8270C
Bis-2-ethylhexyl Adipate	U	U	µg/Kg	33	99	3550/8270C
Aldrin	U	U	µg/Kg	1.0	3.0	3550/8270C
-BHC	U	U	µg/Kg	3.0	9.0	3550/8270C
-BHC	U	U	µg/Kg	3.0	9.0	3550/8270C
-BHC	U	U	µg/Kg	3.0	9.0	3550/8270C
-BHC (Lindane)	U	U	µg/Kg	1.0	3.0	3550/8270C
Clordane	U	U	µg/Kg	1.0	3.0	3550/8270C
4,4'-DDD	U	U	µg/Kg	2	6	3550/8270C
4,4'-DDE	U	U	µg/Kg	1.39	4017	3550/8270C
4,4'-DDT	U	U	µg/Kg	1.69	5.07	3550/8270C
Dieldrin	U	U	µg/Kg	0.840	2.520	3550/8270C
Endosulfan I	U	U	µg/Kg	1.100	3.300	3550/8270C
Endosulfan II	U	U	µg/Kg	1.60	4.80	3550/8270C
Endosulfan Sulfate	U	U	µg/Kg	1.70	5.10	3550/8270C
Endrin	U	U	µg/Kg	1.800	5.400	3550/8270C
Endrin Aldehyde	U	U	µg/Kg	1.900	5.700	3550/8270C
Heptachlor	U	U	µg/Kg	1.78	5.34	3550/8270C
Heptachlor Epoxide	U	U	µg/Kg	1.68	5.04	3550/8270C
Toxaphene	U	U	µg/Kg	1.90	5.70	3550/8270C
PCB-1016	U	U	µg/Kg	0.30	0.90	3550/8270C
PCB-1221	U	U	µg/Kg	0.30	0.90	3550/8270C
PCB-1232	U	U	µg/Kg	0.30	0.90	3550/8270C
PCB-1242	U	U	µg/Kg	0.30	0.90	3550/8270C

Petroleum Hydrocarbon Speciation Analysis (continued)						
PARAMETER	RESULT	QC	UNITS	MDL	PQL	METHOD
PCB-1248	U	U	µg/Kg	0.30	0.90	3550/8270C
PCB-1254	U	U	µg/Kg	0.30	0.90	3550/8270C
PCB-1260	U	U	µg/Kg	0.30	0.90	3550/8270C
Dioxin	U	U	µg/Kg	30	90	3550/8270C
Azobenzene	U	U	µg/Kg	30	90	3550/8270C
Methoxychlor	U	U	µg/Kg	19	57	3550/8270C
Benzoic Acid	U	U	µg/Kg	30	90	3550/8270C
Aniline	U	U	µg/Kg	30	90	3550/8270C
4-Chloroaniline	U	U	µg/Kg	11	33	3550/8270C
Dibenzofuran	U	U	µg/Kg	30	90	3550/8270C
2-Nitroaniline	U	U	µg/Kg	37	111	3550/8270C
30Nitroaniline	U	U	µg/Kg	30	90	3550/8270C
4-Nitroaniline	U	U	µg/Kg	30	90	3550/8270C
Carbazole	U	U	µg/Kg	30	90	3550/8270C
2,6-Dichlorophenol	U	U	µg/Kg	17	51	3550/8270C
2,3,4,6-Tetrachlorophenol	U	U	µg/Kg	30	90	3550/8270C
2,3,5,6-Tetrachlorophenol	U	U	µg/Kg	30	90	3550/8270C
Pyridine	U	U	µg/Kg	67	201	3550/8270C
FL-PRO (Petroleum Residual Organic Totals) Soil Dilution Factor = 1						
TOTAL PRO (C8-C40)	2.18		mg/Kg	0.01	0.03	FL-PRO
TPHCWG TPH-CWG Speciation Method (Soils) Dilution Factor = 1						
C5-C7 Aromatics	U	U	µg/Kg	5.0	15.0	TPHCWG
C7-C8 Aromatics	U	U	µg/Kg	5.0	15.0	TPHCWG
C8-C10 Aromatics	U	U	µg/Kg	5.0	15.0	TPHCWG
C10-C12 Aromatics	U	U	µg/Kg	5.0	15.0	TPHCWG
C12-C16 Aromatics	U	U	µg/Kg	5.0	15.0	TPHCWG
C16-C21 Aromatics	U	U	µg/Kg	5.0	15.0	TPHCWG
C21-C35 Aromatics	U	U	µg/Kg	5.0	15.0	TPHCWG
C5-C6 Aliphatics	U	U	µg/Kg	5.0	15.0	TPHCWG
C6-C8 Aliphatics	U	U	µg/Kg	5.0	15.0	TPHCWG
C8-C10 Aliphatics	U	U	µg/Kg	5.0	15.0	TPHCWG
C10-C12 Aliphatics	U	U	µg/Kg	5.0	15.0	TPHCWG
C12-C16 Aliphatics	U	U	µg/Kg	5.0	15.0	TPHCWG
C16-C35 Aliphatics	U	U	µg/Kg	5.0	15.0	TPHCWG

QC=Qualifier Code as defined by DEP 62-160; U=Undetected; MDL=Minimum Detection Limit; PQL=Practical Quantation Limit.

BLIND PASS SEDIMENT CORE BP-90 (221-223 cm)

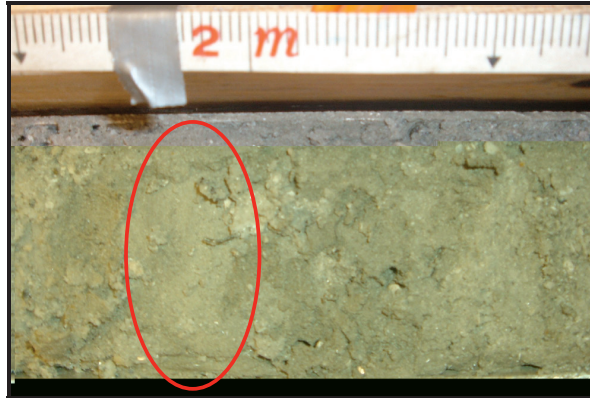

Red circle indicates area sampled for GC/MS.

C₈-C₄₀ Table						
PARAMETER	RESULT	QC	UNITS	MDL	PQL	METHOD
Percent Solids	59.8		%	0.1	0.3	EPA 160.3
FL-PRO (Petroleum Residual Organic Totals) Soil Dilution Factor = 1						
TOTAL PRO (C8-C40)	6.47	Q	mg/Kg	0.01	0.03	FL-PRO

QC=Qualifier Code as defined by DEP 62-160; U=Undetected; I=In between the MDL and PQL; Q= Out of hold; MDL=Minimum Detection Limit; PQL=Practical Quantation Limit.

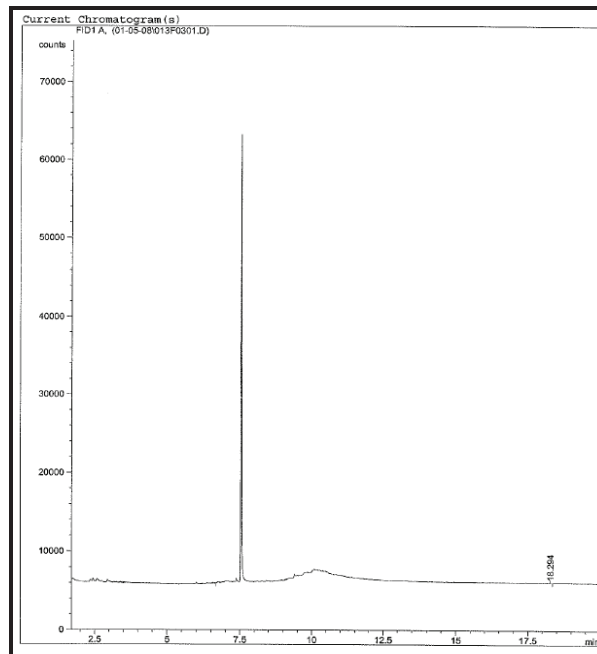

Chromatogram for sediment core 90 (221-223 cm).

Petroleum Hydrocarbon Speciation Analysis						
PARAMETER	RESULT	QC	UNITS	MDL	PQL	METHOD
Percent Solids	59.8		%	0.1	0.3	EPA 160.3
8260B VOA Compounds in Solids & Wastes GC/MS Dilution Factor = 1						
Methyl-tert-butyl-ether	3.16	Q	µg/Kg	0.7	2.1	5035/8260B
Methyl Ether Ketone	6.61	Q	µg/Kg	1.0	3.1	5035/8260B
Benzene	U	U	µg/Kg	0.5	1.6	5035/8260B
Toluene	U	U	µg/Kg	0.5	1.5	5035/8260B
Chlorobenzene	U	U	µg/Kg	0.7	2.1	5035/8260B
Ethylbenzene	U	U	µg/Kg	0.7	2.1	5035/8260B
M & p Xylene	U	U	µg/Kg	1.5	4.5	5035/8260B
o-Xylene	U	U	µg/Kg	0.7	2.1	5035/8260B
1,3-Dichlorobenzene	U	U	µg/Kg	1.0	3.0	5035/8260B
1,4-Dichlorobenzene	U	U	µg/Kg	0.8	2.4	5035/8260B
1,2-Dichlorobenzene	U	U	µg/Kg	0.7	2.1	5035/8260B
8270C Semivolatile Organics in Solids by GC/MS Dilution Factor = 1						
N-Nitrosodimethylamine	U	U	µg/Kg	69	207	3550/8270C
Phenol	U	U	µg/Kg	43	129	3550/8270C
2-Methyl Phenol (o-cresol)	U	U	µg/Kg	62	186	3550/8270C
3-Methyl Phenol (m-cresol)	U	U	µg/Kg	46	138	3550/8270C
4-Methyl Phenol (p-cresol)	U	U	µg/Kg	37	111	3550/8270C
Bis (2-Chloroethyl) Ether	U	U	µg/Kg	47	141	3550/8270C
2-Chlorophenol	U	U	µg/Kg	27.0	81.0	3550/8270C
1,3-Dichlorobenzene	U	U	µg/Kg	3.2	9.6	3550/8270C
1,4-Dichlorobenzene	U	U	µg/Kg	2.0	6.0	3550/8270C
Benzyl Alcohol	U	U	µg/Kg	3	9	3550/8270C
1,2-Dichlorobenzene	U	U	µg/Kg	3.5	10.5	3550/8270C
Bis (2-Chloroisopropyl) Ether	U	U	µg/Kg	47	141	3550/8270C
N-Nitrosodi-N-Propylamine	U	U	µg/Kg	24.0	72.0	3550/8270C
Hexachloroethane	U	U	µg/Kg	67	201	3550/8270C
Nitrobenzene	U	U	µg/Kg	38	114	3550/8270C
Isophorone	U	U	µg/Kg	76	228	3550/8270C
2-Nitrophenol	U	U	µg/Kg	78	234	3550/8270C
2,4-Dimethylphenol	U	U	µg/Kg	72	216	3550/8270C
Bis (2-Chloroethoxy)methane	U	U	µg/Kg	81	243	3550/8270C
2,4-Dichlorophenol	U	U	µg/Kg	59	177	3550/8270C
1,2,3-Trichlorobenzene	U	U	µg/Kg	32	96	3550/8270C
1,2,4-Trichlorobenzene	U	U	µg/Kg	42	126	3550/8270C
Naphthalene	U	U	µg/Kg	1	3	3550/8270C
Hexachlorobutadiene	U	U	µg/Kg	14	42	3550/8270C
4-Chloro-3-Methylphenol	U	U	µg/Kg	66	198	3550/8270C
1-Methylnaphthalene	U	U	µg/Kg	1	3	3550/8270C
2-Methylnaphthlene	U	U	µg/Kg	1	3	3550/8270C
Hexachlorocyclopentadiene	U	U	µg/Kg	41	123	3550/8270C
2,3,6-Trichlorophenol	U	U	µg/Kg	98	294	3550/8270C
2,4,5-Trichlorophenol	U	U	µg/Kg	60	180	3550/8270C
2,4,6-Trichlorophenol	U	U	µg/Kg	53	159	3550/8270C
2-Chloronaphthalene	U	U	µg/Kg	34	102	3550/8270C
Dimethyl Phthalate	U	U	µg/Kg	38	114	3550/8270C
Acenaphthylene	U	U	µg/Kg	2.0	6.0	3550/8270C
2,6-Dinitrotoluene	U	U	µg/Kg	26	78	3550/8270C
Acenaphthene	U	U	µg/Kg	1.3	3.9	3550/8270C

Petroleum Hydrocarbon Speciation Analysis (continued)						
PARAMETER	RESULT	QC	UNITS	MDL	PQL	METHOD
2,4-Dinitrotoluene	U	U	µg/Kg	41	123	3550/8270C
4-Nitrophenol	U	U	µg/Kg	37	111	3550/8270C
Diethyl Phthalate	U	U	µg/Kg	35	105	3550/8270C
Fluorene	U	U	µg/Kg	1.0	3.0	3550/8270C
4-Chlorophenyl Phenyl Ether	U	U	µg/Kg	45	135	3550/8270C
4,6-Dinitro-2-Methylphenol	U	U	µg/Kg	36	108	3550/8270C
N-Nitrosodiphenylamine	U	U	µg/Kg	51	153	3550/8270C
4-Bromophenyl Phenyl Ether	U	U	µg/Kg	38	114	3550/8270C
Hexachlorobenzene	U	U	µg/Kg	36	108	3550/8270C
Pentachlorophenol	U	U	µg/Kg	1.7	5.1	3550/8270C
Phenanthrene	3.11	I	µg/Kg	2	6	3550/8270C
Anthracene	U	U	µg/Kg	0.6	1.8	3550/8270C
Di-N-Butyl Phthalate	U	U	µg/Kg	34	102	3550/8270C
Fluoranthene	11.9	I	µg/Kg	1.6	4.8	3550/8270C
Benzidine	U	U	µg/Kg	33	99	3550/8270C
Pyrene	8.54	I	µg/Kg	2	6	3550/8270C
Butyl Benzyl Phthalate	U	U	µg/Kg	50	150	3550/8270C
Benzo(A)Anthracene	2.33	I	µg/Kg	1	3	3550/8270C
3,3-Dichlorobenzidine	U	U	µg/Kg	100	300	3550/8270C
Chrysene	U	U	µg/Kg	1	3	3550/8270C
Bis (2 Ethylhexyl) Phthalate	U	U	µg/Kg	39	117	3550/8270C
Di-N-Octyl Phthalate	U	U	µg/Kg	44	132	3550/8270C
Benzo(B)Fluoranthene	1.68	I	µg/Kg	1	3	3550/8270C
Benzo(K)Fluoranthene	U	U	µg/Kg	1	3	3550/8270C
Benzo(A)Pyrene	1.09	I	µg/Kg	1	3	3550/8270C
Indeno(1,2,3-CD)Pyrene	U	U	µg/Kg	2	6	3550/8270C
Dibenzo (A,H) Anthracene	U	U	µg/Kg	2	6	3550/8270C
Benzo(G,H,I)Perylene	U	U	µg/Kg	2	6	3550/8270C
Bis-2-ethylexyl Adipate	U	U	µg/Kg	33	99	3550/8270C
Aldrin	U	U	µg/Kg	1.0	3.0	3550/8270C
-BHC	U	U	µg/Kg	3.0	9.0	3550/8270C
-BHC	U	U	µg/Kg	3.0	9.0	3550/8270C
-BHC	U	U	µg/Kg	3.0	9.0	3550/8270C
-BHC (Lindane)	U	U	µg/Kg	1.0	3.0	3550/8270C
Clordane	U	U	µg/Kg	1.0	3.0	3550/8270C
4,4'-DDD	U	U	µg/Kg	2	6	3550/8270C
4,4'-DDE	U	U	µg/Kg	1.39	4017	3550/8270C
4,4'-DDT	U	U	µg/Kg	1.69	5.07	3550/8270C
Dieldrin	U	U	µg/Kg	0.840	2.520	3550/8270C
Endosulfan I	U	U	µg/Kg	1.100	3.300	3550/8270C
Endosulfan II	U	U	µg/Kg	1.60	4.80	3550/8270C
Endosulfan Sulfate	U	U	µg/Kg	1.70	5.10	3550/8270C
Endrin	U	U	µg/Kg	1.800	5.400	3550/8270C
Endrin Aldehyde	U	U	µg/Kg	1.900	5.700	3550/8270C
Heptachlor	U	U	µg/Kg	1.78	5.34	3550/8270C
Heptachlor Epoxide	U	U	µg/Kg	1.68	5.04	3550/8270C
Toxaphene	U	U	µg/Kg	1.90	5.70	3550/8270C
PCB-1016	U	U	µg/Kg	0.30	0.90	3550/8270C
PCB-1221	U	U	µg/Kg	0.30	0.90	3550/8270C
PCB-1232	U	U	µg/Kg	0.30	0.90	3550/8270C
PCB-1242	U	U	µg/Kg	0.30	0.90	3550/8270C

Petroleum Hydrocarbon Speciation Analysis (continued)						
PARAMETER	RESULT	QC	UNITS	MDL	PQL	METHOD
PCB-1248	U	U	µg/Kg	0.30	0.90	3550/8270C
PCB-1254	U	U	µg/Kg	0.30	0.90	3550/8270C
PCB-1260	U	U	µg/Kg	0.30	0.90	3550/8270C
Dioxin	U	U	µg/Kg	30	90	3550/8270C
Azobenzene	U	U	µg/Kg	30	90	3550/8270C
Methoxychlor	U	U	µg/Kg	19	57	3550/8270C
Benzoic Acid	U	U	µg/Kg	30	90	3550/8270C
Aniline	U	U	µg/Kg	30	90	3550/8270C
4-Chloroaniline	U	U	µg/Kg	11	33	3550/8270C
Dibenzofuran	U	U	µg/Kg	30	90	3550/8270C
2-Nitroaniline	U	U	µg/Kg	37	111	3550/8270C
30Nitroaniline	U	U	µg/Kg	30	90	3550/8270C
4-Nitroaniline	U	U	µg/Kg	30	90	3550/8270C
Carbazole	U	U	µg/Kg	30	90	3550/8270C
2,6-Dichlorophenol	U	U	µg/Kg	17	51	3550/8270C
2,3,4,6-Tetrachlorophenol	U	U	µg/Kg	30	90	3550/8270C
2,3,5,6-Tetrachlorophenol	U	U	µg/Kg	30	90	3550/8270C
Pyridine	U	U	µg/Kg	67	201	3550/8270C
FL-PRO (Petroleum Residual Organic Totals) Soil Dilution Factor = 1						
TOTAL PRO (C8-C40)	6.47		mg/Kg	0.01	0.03	FL-PRO
TPHCWG TPH-CWG Speciation Method (Soils) Dilution Factor = 1						
C5-C7 Aromatics	U	U	µg/Kg	5.0	15.0	TPHCWG
C7-C8 Aromatics	U	U	µg/Kg	5.0	15.0	TPHCWG
C8-C10 Aromatics	U	U	µg/Kg	5.0	15.0	TPHCWG
C10-C12 Aromatics	U	U	µg/Kg	5.0	15.0	TPHCWG
C12-C16 Aromatics	23.6	Q	µg/Kg	5.0	15.0	TPHCWG
C16-C21 Aromatics	5.10	QI	µg/Kg	5.0	15.0	TPHCWG
C21-C35 Aromatics	U	U	µg/Kg	5.0	15.0	TPHCWG
C5-C6 Aliphatics	U	U	µg/Kg	5.0	15.0	TPHCWG
C6-C8 Aliphatics	U	U	µg/Kg	5.0	15.0	TPHCWG
C8-C10 Aliphatics	U	U	µg/Kg	5.0	15.0	TPHCWG
C10-C12 Aliphatics	U	U	µg/Kg	5.0	15.0	TPHCWG
C12-C16 Aliphatics	U	U	µg/Kg	5.0	15.0	TPHCWG
C16-C35 Aliphatics	6,470	QI	µg/Kg	5.0	15.0	TPHCWG

QC=Qualifier Code as defined by DEP 62-160; U=Undetected; MDL=Minimum Detection Limit; PQL=Practical Quantation Limit.

BLIND PASS SEDIMENT CORE BP-91 (238-243 cm)



Red circle indicates area sampled for GC/MS.

C₈-C₄₀ Table						
PARAMETER	RESULT	QC	UNITS	MDL	PQL	METHOD
Percent Solids	80.1		%	0.1	0.3	EPA 160.3
FL-PRO (Petroleum Residual Organic Totals) Soil Dilution Factor = 1						
TOTAL PRO (C8-C40)	2.52	Q	mg/Kg	0.01	0.03	FL-PRO

QC=Qualifier Code as defined by DEP 62-160; U=Undetected; I=In between the MDL and PQL; Q= Out of hold; MDL=Minimum Detection Limit; PQL=Practical Quantation Limit.

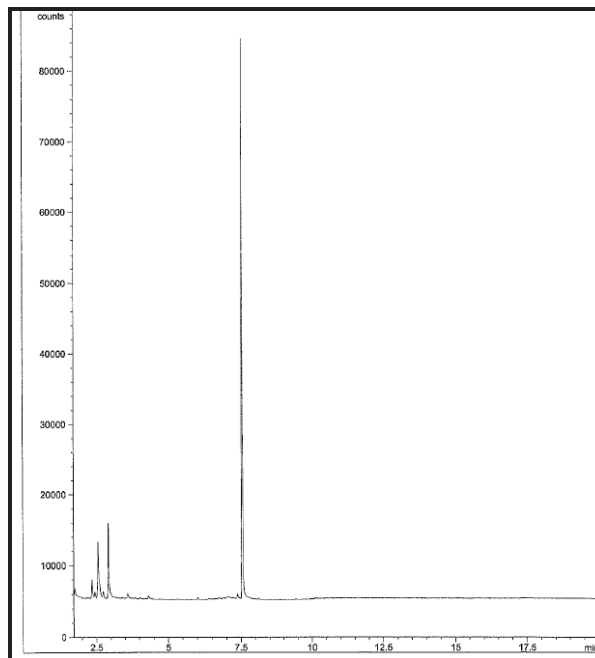

Chromatogram for sediment core BP-91 (238-243 cm).

Petroleum Hydrocarbon Speciation Analysis						
PARAMETER	RESULT	QC	UNITS	MDL	PQL	METHOD
Percent Solids	80.1		%	0.1	0.3	EPA 160.3
8260B VOA Compounds in Solids & Wastes GC/MS Dilution Factor = 1						
Methyl-tert-butyl-ether	2.17	Q	µg/Kg	0.7	2.1	5035/8260B
Methyl Ether Ketone	U	U	µg/Kg	1.0	3.1	5035/8260B
Benzene	U	U	µg/Kg	0.5	1.6	5035/8260B
Toluene	U	U	µg/Kg	0.5	1.5	5035/8260B
Chlorobenzene	U	U	µg/Kg	0.7	2.1	5035/8260B
Ethylbenzene	U	U	µg/Kg	0.7	2.1	5035/8260B
M & p Xylene	U	U	µg/Kg	1.5	4.5	5035/8260B
o-Xylene	U	U	µg/Kg	0.7	2.1	5035/8260B
1,3-Dichlorobenzene	U	U	µg/Kg	1.0	3.0	5035/8260B
1,4-Dichlorobenzene	U	U	µg/Kg	0.8	2.4	5035/8260B
1,2-Dichlorobenzene	U	U	µg/Kg	0.7	2.1	5035/8260B
8270C Semivolatile Organics in Solids by GC/MS Dilution Factor = 1						
N-Nitrosodimethylamine	U	U	µg/Kg	69	207	3550/8270C
Phenol	U	U	µg/Kg	43	129	3550/8270C
2-Methyl Phenol (o-cresol)	U	U	µg/Kg	62	186	3550/8270C
3-Methyl Phenol (m-cresol)	U	U	µg/Kg	46	138	3550/8270C
4-Methyl Phenol (p-cresol)	U	U	µg/Kg	37	111	3550/8270C
Bis (2-Chloroethyl) Ether	U	U	µg/Kg	47	141	3550/8270C
2-Chlorophenol	U	U	µg/Kg	27.0	81.0	3550/8270C
1,3-Dichlorobenzene	U	U	µg/Kg	3.2	9.6	3550/8270C
1,4-Dichlorobenzene	U	U	µg/Kg	2.0	6.0	3550/8270C
Benzyl Alcohol	U	U	µg/Kg	3	9	3550/8270C
1,2-Dichlorobenzene	U	U	µg/Kg	3.5	10.5	3550/8270C
Bis (2-Chloroisopropyl) Ether	U	U	µg/Kg	47	141	3550/8270C
N-Nitrosodi-N-Propylamine	U	U	µg/Kg	24.0	72.0	3550/8270C
Hexachloroethane	U	U	µg/Kg	67	201	3550/8270C
Nitrobenzene	U	U	µg/Kg	38	114	3550/8270C
Isophorone	U	U	µg/Kg	76	228	3550/8270C
2-Nitrophenol	U	U	µg/Kg	78	234	3550/8270C
2,4-Dimethylphenol	U	U	µg/Kg	72	216	3550/8270C
Bis (2-Chloroethoxy)methane	U	U	µg/Kg	81	243	3550/8270C
2,4-Dichlorophenol	U	U	µg/Kg	59	177	3550/8270C
1,2,3-Trichlorobenzene	U	U	µg/Kg	32	96	3550/8270C
1,2,4-Trichlorobenzene	U	U	µg/Kg	42	126	3550/8270C
Naphthalene	U	U	µg/Kg	1	3	3550/8270C
Hexachlorobutadiene	U	U	µg/Kg	14	42	3550/8270C
4-Chloro-3-Methylphenol	U	U	µg/Kg	66	198	3550/8270C
1-Methylnaphthalene	U	U	µg/Kg	1	3	3550/8270C
2-Methylnaphthlene	U	U	µg/Kg	1	3	3550/8270C
Hexachlorocyclopentadiene	U	U	µg/Kg	41	123	3550/8270C
2,3,6-Trichlorophenol	U	U	µg/Kg	98	294	3550/8270C
2,4,5-Trichlorophenol	U	U	µg/Kg	60	180	3550/8270C
2,4,6-Trichlorophenol	U	U	µg/Kg	53	159	3550/8270C
2-Chloronaphthalene	U	U	µg/Kg	34	102	3550/8270C
Dimethyl Phthalate	U	U	µg/Kg	38	114	3550/8270C
Acenaphthylene	U	U	µg/Kg	2.0	6.0	3550/8270C
2,6-Dinitrotoluene	U	U	µg/Kg	26	78	3550/8270C
Acenaphthene	U	U	µg/Kg	1.3	3.9	3550/8270C

Petroleum Hydrocarbon Speciation Analysis (continued)						
PARAMETER	RESULT	QC	UNITS	MDL	PQL	METHOD
2,4-Dinitrotoluene	U	U	µg/Kg	41	123	3550/8270C
4-Nitrophenol	U	U	µg/Kg	37	111	3550/8270C
Diethyl Phthalate	U	U	µg/Kg	35	105	3550/8270C
Fluorene	U	U	µg/Kg	1.0	3.0	3550/8270C
4-Chlorophenyl Phenyl Ether	U	U	µg/Kg	45	135	3550/8270C
4,6-Dinitro-2-Methylphenol	U	U	µg/Kg	36	108	3550/8270C
N-Nitrosodiphenylamine	U	U	µg/Kg	51	153	3550/8270C
4-Bromophenyl Phenyl Ether	U	U	µg/Kg	38	114	3550/8270C
Hexachlorobenzene	U	U	µg/Kg	36	108	3550/8270C
Pentachlorophenol	U	U	µg/Kg	1.7	5.1	3550/8270C
Phenanthrene	5.12	I	µg/Kg	2	6	3550/8270C
Anthracene	U	U	µg/Kg	0.6	1.8	3550/8270C
Di-N-Butyl Phthalate	U	U	µg/Kg	34	102	3550/8270C
Fluoranthene	6.12	I	µg/Kg	1.6	4.8	3550/8270C
Benzidine	U	U	µg/Kg	33	99	3550/8270C
Pyrene	4.19	I	µg/Kg	2	6	3550/8270C
Butyl Benzyl Phthalate	U	U	µg/Kg	50	150	3550/8270C
Benzo(A)Anthracene	1.26	I	µg/Kg	1	3	3550/8270C
3,3-Dichlorobenzidine	U	U	µg/Kg	100	300	3550/8270C
Chrysene	U	U	µg/Kg	1	3	3550/8270C
Bis (2 Ethylhexyl) Phthalate	U	U	µg/Kg	39	117	3550/8270C
Di-N-Octyl Phthalate	U	U	µg/Kg	44	132	3550/8270C
Benzo(B)Fluoranthene	1.14	I	µg/Kg	1	3	3550/8270C
Benzo(K)Fluoranthene	U	U	µg/Kg	1	3	3550/8270C
Benzo(A)Pyrene	U	U	µg/Kg	1	3	3550/8270C
Indeno(1,2,3-CD)Pyrene	U	U	µg/Kg	2	6	3550/8270C
Dibenzo (A,H) Anthracene	U	U	µg/Kg	2	6	3550/8270C
Benzo(G,H,I)Perylene	U	U	µg/Kg	2	6	3550/8270C
Bis-2-ethylexyl Adipate	U	U	µg/Kg	33	99	3550/8270C
Aldrin	U	U	µg/Kg	1.0	3.0	3550/8270C
-BHC	U	U	µg/Kg	3.0	9.0	3550/8270C
-BHC	U	U	µg/Kg	3.0	9.0	3550/8270C
-BHC	U	U	µg/Kg	3.0	9.0	3550/8270C
-BHC (Lindane)	U	U	µg/Kg	1.0	3.0	3550/8270C
Clordane	U	U	µg/Kg	1.0	3.0	3550/8270C
4,4'-DDD	U	U	µg/Kg	2	6	3550/8270C
4,4'-DDE	U	U	µg/Kg	1.39	4017	3550/8270C
4,4'-DDT	U	U	µg/Kg	1.69	5.07	3550/8270C
Dieldrin	U	U	µg/Kg	0.840	2.520	3550/8270C
Endosulfan I	U	U	µg/Kg	1.100	3.300	3550/8270C
Endosulfan II	U	U	µg/Kg	1.60	4.80	3550/8270C
Endosulfan Sulfate	U	U	µg/Kg	1.70	5.10	3550/8270C
Endrin	U	U	µg/Kg	1.800	5.400	3550/8270C
Endrin Aldehyde	U	U	µg/Kg	1.900	5.700	3550/8270C
Heptachlor	U	U	µg/Kg	1.78	5.34	3550/8270C
Heptachlor Epoxide	U	U	µg/Kg	1.68	5.04	3550/8270C
Toxaphene	U	U	µg/Kg	1.90	5.70	3550/8270C
PCB-1016	U	U	µg/Kg	0.30	0.90	3550/8270C
PCB-1221	U	U	µg/Kg	0.30	0.90	3550/8270C
PCB-1232	U	U	µg/Kg	0.30	0.90	3550/8270C
PCB-1242	U	U	µg/Kg	0.30	0.90	3550/8270C

Petroleum Hydrocarbon Speciation Analysis (continued)						
PARAMETER	RESULT	QC	UNITS	MDL	PQL	METHOD
PCB-1248	U	U	µg/Kg	0.30	0.90	3550/8270C
PCB-1254	U	U	µg/Kg	0.30	0.90	3550/8270C
PCB-1260	U	U	µg/Kg	0.30	0.90	3550/8270C
Dioxin	U	U	µg/Kg	30	90	3550/8270C
Azobenzene	U	U	µg/Kg	30	90	3550/8270C
Methoxychlor	U	U	µg/Kg	19	57	3550/8270C
Benzoic Acid	U	U	µg/Kg	30	90	3550/8270C
Aniline	U	U	µg/Kg	30	90	3550/8270C
4-Chloroaniline	U	U	µg/Kg	11	33	3550/8270C
Dibenzofuran	U	U	µg/Kg	30	90	3550/8270C
2-Nitroaniline	U	U	µg/Kg	37	111	3550/8270C
30Nitroaniline	U	U	µg/Kg	30	90	3550/8270C
4-Nitroaniline	U	U	µg/Kg	30	90	3550/8270C
Carbazole	U	U	µg/Kg	30	90	3550/8270C
2,6-Dichlorophenol	U	U	µg/Kg	17	51	3550/8270C
2,3,4,6-Tetrachlorophenol	U	U	µg/Kg	30	90	3550/8270C
2,3,5,6-Tetrachlorophenol	U	U	µg/Kg	30	90	3550/8270C
Pyridine	U	U	µg/Kg	67	201	3550/8270C
FL-PRO (Petroleum Residual Organic Totals) Soil Dilution Factor = 1						
TOTAL PRO (C8-C40)	2.52		mg/Kg	0.01	0.03	FL-PRO
TPHCWG TPH-CWG Speciation Method (Soils) Dilution Factor = 1						
C5-C7 Aromatics	U	U	µg/Kg	5.0	15.0	TPHCWG
C7-C8 Aromatics	U	U	µg/Kg	5.0	15.0	TPHCWG
C8-C10 Aromatics	U	U	µg/Kg	5.0	15.0	TPHCWG
C10-C12 Aromatics	U	U	µg/Kg	5.0	15.0	TPHCWG
C12-C16 Aromatics	15.4	Q	µg/Kg	5.0	15.0	TPHCWG
C16-C21 Aromatics	U	U	µg/Kg	5.0	15.0	TPHCWG
C21-C35 Aromatics	U	U	µg/Kg	5.0	15.0	TPHCWG
C5-C6 Aliphatics	U	U	µg/Kg	5.0	15.0	TPHCWG
C6-C8 Aliphatics	U	U	µg/Kg	5.0	15.0	TPHCWG
C8-C10 Aliphatics	U	U	µg/Kg	5.0	15.0	TPHCWG
C10-C12 Aliphatics	U	U	µg/Kg	5.0	15.0	TPHCWG
C12-C16 Aliphatics	U	U	µg/Kg	5.0	15.0	TPHCWG
C16-C35 Aliphatics	U	U	µg/Kg	5.0	15.0	TPHCWG

QC=Qualifier Code as defined by DEP 62-160; U=Undetected; MDL=Minimum Detection Limit; PQL=Practical Quantation Limit.

BLIND PASS SEDIMENT CORE BP-88 (215-217 cm)

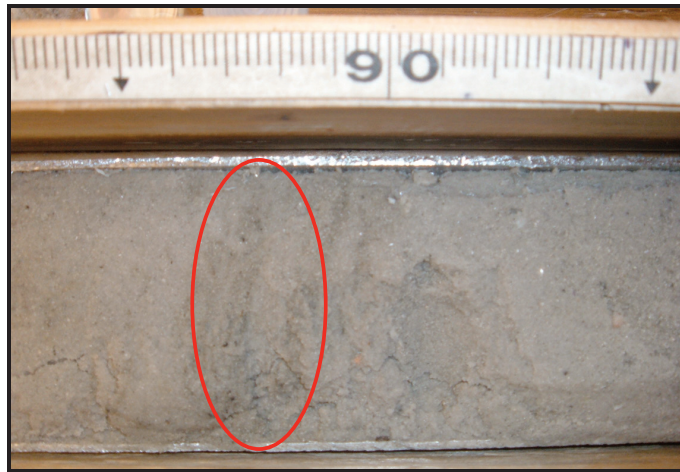

Red circle indicates area sampled for GC/MS.

C₈-C₄₀ Table						
PARAMETER	RESULT	QC	UNITS	MDL	PQL	METHOD
Percent Solids	80.1		%	0.1	0.3	EPA 160.3
FL-PRO (Petroleum Residual Organic Totals) Soil Dilution Factor = 1						
TOTAL PRO (C8-C40)	4.17	Q	mg/Kg	0.01	0.03	FL-PRO

QC=Qualifier Code as defined by DEP 62-160; U=Undetected; I=In between the MDL and PQL; Q= Out of hold; MDL=Minimum Detection Limit; PQL=Practical Quantation Limit.

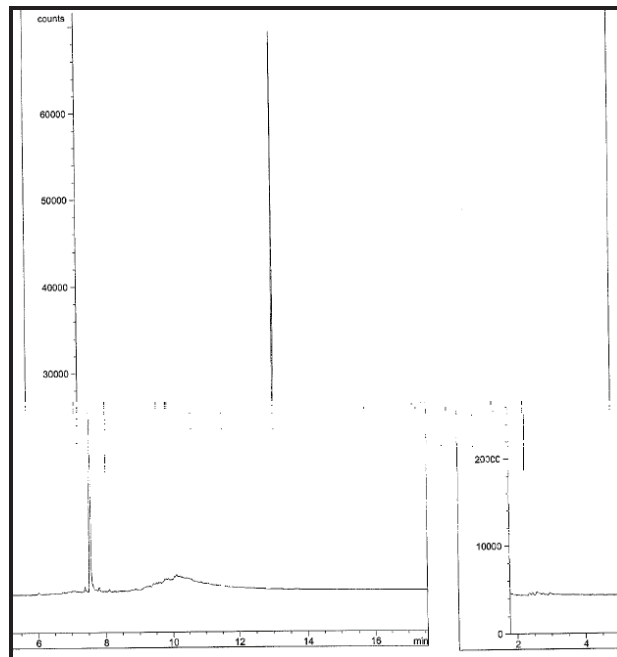

Chromatogram for sediment core BP-88 (215-217 cm).

Petroleum Hydrocarbon Speciation Analysis						
PARAMETER	RESULT	QC	UNITS	MDL	PQL	METHOD
Percent Solids	80.4		%	0.1	0.3	EPA 160.3
8260B VOA Compounds in Solids & Wastes GC/MS Dilution Factor = 1						
Methyl-tert-butyl-ether	2.22	Q	µg/Kg	0.7	2.1	5035/8260B
Methyl Ether Ketone	U	U	µg/Kg	1.0	3.1	5035/8260B
Benzene	U	U	µg/Kg	0.5	1.6	5035/8260B
Toluene	U	U	µg/Kg	0.5	1.5	5035/8260B
Chlorobenzene	U	U	µg/Kg	0.7	2.1	5035/8260B
Ethylbenzene	U	U	µg/Kg	0.7	2.1	5035/8260B
M & p Xylene	U	U	µg/Kg	1.5	4.5	5035/8260B
o-Xylene	U	U	µg/Kg	0.7	2.1	5035/8260B
1,3-Dichlorobenzene	U	U	µg/Kg	1.0	3.0	5035/8260B
1,4-Dichlorobenzene	U	U	µg/Kg	0.8	2.4	5035/8260B
1,2-Dichlorobenzene	U	U	µg/Kg	0.7	2.1	5035/8260B
8270C Semivolatile Organics in Solids by GC/MS Dilution Factor = 1						
N-Nitrosodimethylamine	U	U	µg/Kg	69	207	3550/8270C
Phenol	U	U	µg/Kg	43	129	3550/8270C
2-Methyl Phenol (o-cresol)	U	U	µg/Kg	62	186	3550/8270C
3-Methyl Phenol (m-cresol)	U	U	µg/Kg	46	138	3550/8270C
4-Methyl Phenol (p-cresol)	U	U	µg/Kg	37	111	3550/8270C
Bis (2-Chloroethyl) Ether	U	U	µg/Kg	47	141	3550/8270C
2-Chlorophenol	U	U	µg/Kg	27.0	81.0	3550/8270C
1,3-Dichlorobenzene	U	U	µg/Kg	3.2	9.6	3550/8270C
1,4-Dichlorobenzene	U	U	µg/Kg	2.0	6.0	3550/8270C
Benzyl Alcohol	U	U	µg/Kg	3	9	3550/8270C
1,2-Dichlorobenzene	U	U	µg/Kg	3.5	10.5	3550/8270C
Bis (2-Chloroisopropyl) Ether	U	U	µg/Kg	47	141	3550/8270C
N-Nitrosodi-N-Proplamine	U	U	µg/Kg	24.0	72.0	3550/8270C
Hexachloroethane	U	U	µg/Kg	67	201	3550/8270C
Nitrobenzene	U	U	µg/Kg	38	114	3550/8270C
Isophorone	U	U	µg/Kg	76	228	3550/8270C
2-Nitrophenol	U	U	µg/Kg	78	234	3550/8270C
2,4-Dimethylphenol	U	U	µg/Kg	72	216	3550/8270C
Bis (2-Chloroethoxy)methane	U	U	µg/Kg	81	243	3550/8270C
2,4-Dichlorophenol	U	U	µg/Kg	59	177	3550/8270C
1,2,3-Trichlorobenzene	U	U	µg/Kg	32	96	3550/8270C
1,2,4-Trichlorobenzene	U	U	µg/Kg	42	126	3550/8270C
Naphthalene	U	U	µg/Kg	1	3	3550/8270C
Hexachlorobutadiene	U	U	µg/Kg	14	42	3550/8270C
4-Chloro-3-Methylphenol	U	U	µg/Kg	66	198	3550/8270C
1-Methylnaphthalene	U	U	µg/Kg	1	3	3550/8270C
2-Methylnaphthlene	U	U	µg/Kg	1	3	3550/8270C
Hexachlorocyclopentadiene	U	U	µg/Kg	41	123	3550/8270C
2,3,6-Trichlorophenol	U	U	µg/Kg	98	294	3550/8270C
2,4,5-Trichlorophenol	U	U	µg/Kg	60	180	3550/8270C
2,4,6-Trichlorophenol	U	U	µg/Kg	53	159	3550/8270C
2-Chloronaphthalene	U	U	µg/Kg	34	102	3550/8270C
Dimethyl Phthalate	U	U	µg/Kg	38	114	3550/8270C
Acenaphthylene	U	U	µg/Kg	2.0	6.0	3550/8270C
2,6-Dinitrotoluene	U	U	µg/Kg	26	78	3550/8270C
Acenaphthene	U	U	µg/Kg	1.3	3.9	3550/8270C

Petroleum Hydrocarbon Speciation Analysis (continued)						
PARAMETER	RESULT	QC	UNITS	MDL	PQL	METHOD
2,4-Dinitrotoluene	U	U	µg/Kg	41	123	3550/8270C
4-Nitrophenol	U	U	µg/Kg	37	111	3550/8270C
Diethyl Phthalate	U	U	µg/Kg	35	105	3550/8270C
Fluorene	U	U	µg/Kg	1.0	3.0	3550/8270C
4-Chlorophenyl Phenyl Ether	U	U	µg/Kg	45	135	3550/8270C
4,6-Dinitro-2-Methylphenol	U	U	µg/Kg	36	108	3550/8270C
N-Nitrosodiphenylamine	U	U	µg/Kg	51	153	3550/8270C
4-Bromophenyl Phenyl Ether	U	U	µg/Kg	38	114	3550/8270C
Hexachlorobenzene	U	U	µg/Kg	36	108	3550/8270C
Pentachlorophenol	U	U	µg/Kg	1.7	5.1	3550/8270C
Phenanthrene	3.30	I	µg/Kg	2	6	3550/8270C
Anthracene	U	U	µg/Kg	0.6	1.8	3550/8270C
Di-N-Butyl Phthalate	U	U	µg/Kg	34	102	3550/8270C
Fluoranthene	6.60	I	µg/Kg	1.6	4.8	3550/8270C
Benzidine	U	U	µg/Kg	33	99	3550/8270C
Pyrene	5.91	I	µg/Kg	2	6	3550/8270C
Butyl Benzyl Phthalate	U	U	µg/Kg	50	150	3550/8270C
Benzo(A)Anthracene	U	U	µg/Kg	1	3	3550/8270C
3,3-Dichlorobenzidine	U	U	µg/Kg	100	300	3550/8270C
Chrysene	U	U	µg/Kg	1	3	3550/8270C
Bis (2 Ethylhexyl) Phthalate	U	U	µg/Kg	39	117	3550/8270C
Di-N-Octyl Phthalate	U	U	µg/Kg	44	132	3550/8270C
Benzo(B)Fluoranthene	1.24	I	µg/Kg	1	3	3550/8270C
Benzo(K)Fluoranthene	U	U	µg/Kg	1	3	3550/8270C
Benzo(A)Pyrene	1.52	I	µg/Kg	1	3	3550/8270C
Indeno(1,2,3-CD)Pyrene	U	U	µg/Kg	2	6	3550/8270C
Dibenzo (A,H) Anthracene	U	U	µg/Kg	2	6	3550/8270C
Benzo(G,H,I)Perylene	U	U	µg/Kg	2	6	3550/8270C
Bis-2-ethylexyl Adipate	U	U	µg/Kg	33	99	3550/8270C
Aldrin	U	U	µg/Kg	1.0	3.0	3550/8270C
-BHC	U	U	µg/Kg	3.0	9.0	3550/8270C
-BHC	U	U	µg/Kg	3.0	9.0	3550/8270C
-BHC	U	U	µg/Kg	3.0	9.0	3550/8270C
-BHC (Lindane)	U	U	µg/Kg	1.0	3.0	3550/8270C
Clordane	U	U	µg/Kg	1.0	3.0	3550/8270C
4,4'-DDD	U	U	µg/Kg	2	6	3550/8270C
4,4'-DDE	U	U	µg/Kg	1.39	4017	3550/8270C
4,4'-DDT	U	U	µg/Kg	1.69	5.07	3550/8270C
Dieldrin	U	U	µg/Kg	0.840	2.520	3550/8270C
Endosulfan I	U	U	µg/Kg	1.100	3.300	3550/8270C
Endosulfan II	U	U	µg/Kg	1.60	4.80	3550/8270C
Endosulfan Sulfate	U	U	µg/Kg	1.70	5.10	3550/8270C
Endrin	U	U	µg/Kg	1.800	5.400	3550/8270C
Endrin Aldehyde	U	U	µg/Kg	1.900	5.700	3550/8270C
Heptachlor	U	U	µg/Kg	1.78	5.34	3550/8270C
Heptachlor Epoxide	U	U	µg/Kg	1.68	5.04	3550/8270C
Toxaphene	U	U	µg/Kg	1.90	5.70	3550/8270C
PCB-1016	U	U	µg/Kg	0.30	0.90	3550/8270C
PCB-1221	U	U	µg/Kg	0.30	0.90	3550/8270C
PCB-1232	U	U	µg/Kg	0.30	0.90	3550/8270C
PCB-1242	U	U	µg/Kg	0.30	0.90	3550/8270C

Petroleum Hydrocarbon Speciation Analysis (continued)						
PARAMETER	RESULT	QC	UNITS	MDL	PQL	METHOD
PCB-1248	U	U	µg/Kg	0.30	0.90	3550/8270C
PCB-1254	U	U	µg/Kg	0.30	0.90	3550/8270C
PCB-1260	U	U	µg/Kg	0.30	0.90	3550/8270C
Dioxin	U	U	µg/Kg	30	90	3550/8270C
Azobenzene	U	U	µg/Kg	30	90	3550/8270C
Methoxychlor	U	U	µg/Kg	19	57	3550/8270C
Benzoic Acid	U	U	µg/Kg	30	90	3550/8270C
Aniline	U	U	µg/Kg	30	90	3550/8270C
4-Chloroaniline	U	U	µg/Kg	11	33	3550/8270C
Dibenzofuran	U	U	µg/Kg	30	90	3550/8270C
2-Nitroaniline	U	U	µg/Kg	37	111	3550/8270C
30Nitroaniline	U	U	µg/Kg	30	90	3550/8270C
4-Nitroaniline	U	U	µg/Kg	30	90	3550/8270C
Carbazole	U	U	µg/Kg	30	90	3550/8270C
2,6-Dichlorophenol	U	U	µg/Kg	17	51	3550/8270C
2,3,4,6-Tetrachlorophenol	U	U	µg/Kg	30	90	3550/8270C
2,3,5,6-Tetrachlorophenol	U	U	µg/Kg	30	90	3550/8270C
Pyridine	U	U	µg/Kg	67	201	3550/8270C
FL-PRO (Petroleum Residual Organic Totals) Soil Dilution Factor = 1						
TOTAL PRO (C8-C40)	4.17		mg/Kg	0.01	0.03	FL-PRO
TPHCWG TPH-CWG Speciation Method (Soils) Dilution Factor = 1						
C5-C7 Aromatics	U	U	µg/Kg	5.0	15.0	TPHCWG
C7-C8 Aromatics	U	U	µg/Kg	5.0	15.0	TPHCWG
C8-C10 Aromatics	U	U	µg/Kg	5.0	15.0	TPHCWG
C10-C12 Aromatics	U	U	µg/Kg	5.0	15.0	TPHCWG
C12-C16 Aromatics	15.8	Q	µg/Kg	5.0	15.0	TPHCWG
C16-C21 Aromatics	U	U	µg/Kg	5.0	15.0	TPHCWG
C21-C35 Aromatics	U	U	µg/Kg	5.0	15.0	TPHCWG
C5-C6 Aliphatics	U	U	µg/Kg	5.0	15.0	TPHCWG
C6-C8 Aliphatics	U	U	µg/Kg	5.0	15.0	TPHCWG
C8-C10 Aliphatics	U	U	µg/Kg	5.0	15.0	TPHCWG
C10-C12 Aliphatics	U	U	µg/Kg	5.0	15.0	TPHCWG
C12-C16 Aliphatics	U	U	µg/Kg	5.0	15.0	TPHCWG
C16-C35 Aliphatics	U	U	µg/Kg	5.0	15.0	TPHCWG

QC=Qualifier Code as defined by DEP 62-160; U=Undetected; MDL=Minimum Detection Limit; PQL=Practical Quantation Limit.

BLIND PASS SEDIMENT CORE BP-26 (262-263 cm)



Red circle indicates area sampled for GC/MS.

C₈-C₄₀ Table						
PARAMETER	RESULT	QC	UNITS	MDL	PQL	METHOD
Percent Solids	81.8		%	0.1	0.3	EPA 160.3
FL-PRO (Petroleum Residual Organic Totals) Soil Dilution Factor = 1						
TOTAL PRO (C8-C40)	5.73	Q	mg/Kg	0.01	0.03	FL-PRO

QC=Qualifier Code as defined by DEP 62-160; U=Undetected; I=In between the MDL and PQL; Q= Out of hold; MDL=Minimum Detection Limit; PQL=Practical Quantation Limit.

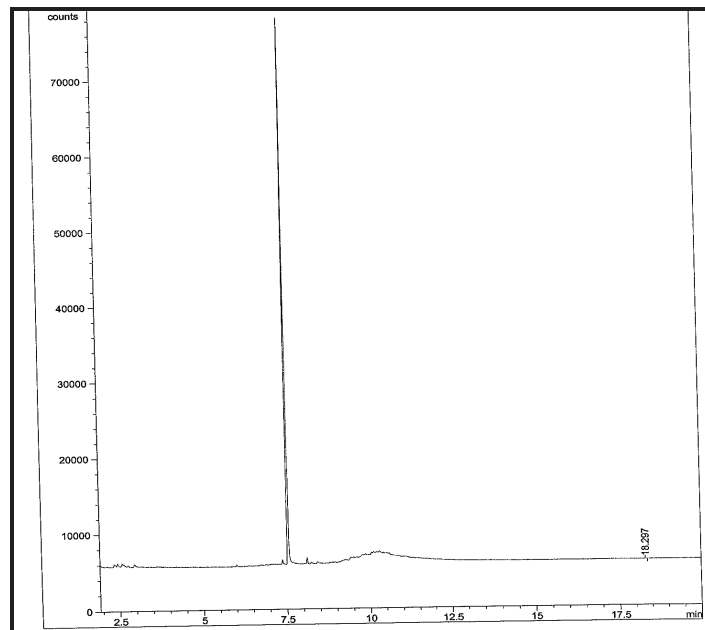

Chromatogram for sediment core BP-26 (262-263 cm).

Petroleum Hydrocarbon Speciation Analysis						
PARAMETER	RESULT	QC	UNITS	MDL	PQL	METHOD
Percent Solids	81.8		%	0.1	0.3	EPA 160.3
8260B VOA Compounds in Solids & Wastes GC/MS Dilution Factor = 1						
Methyl-tert-butyl-ether	1.65	QI	µg/Kg	0.7	2.1	5035/8260B
Methyl Ether Ketone	U	U	µg/Kg	1.0	3.1	5035/8260B
Benzene	U	U	µg/Kg	0.5	1.6	5035/8260B
Toluene	U	U	µg/Kg	0.5	1.5	5035/8260B
Chlorobenzene	U	U	µg/Kg	0.7	2.1	5035/8260B
Ethylbenzene	U	U	µg/Kg	0.7	2.1	5035/8260B
M & p Xylene	U	U	µg/Kg	1.5	4.5	5035/8260B
o-Xylene	U	U	µg/Kg	0.7	2.1	5035/8260B
1,3-Dichlorobenzene	U	U	µg/Kg	1.0	3.0	5035/8260B
1,4-Dichlorobenzene	U	U	µg/Kg	0.8	2.4	5035/8260B
1,2-Dichlorobenzene	U	U	µg/Kg	0.7	2.1	5035/8260B
8270C Semivolatile Organics in Solids by GC/MS Dilution Factor = 1						
N-Nitrosodimethylamine	U	U	µg/Kg	69	207	3550/8270C
Phenol	U	U	µg/Kg	43	129	3550/8270C
2-Methyl Phenol (o-cresol)	U	U	µg/Kg	62	186	3550/8270C
3-Methyl Phenol (m-cresol)	U	U	µg/Kg	46	138	3550/8270C
4-Methyl Phenol (p-cresol)	U	U	µg/Kg	37	111	3550/8270C
Bis (2-Chloroethyl) Ether	U	U	µg/Kg	47	141	3550/8270C
2-Chlorophenol	U	U	µg/Kg	27.0	81.0	3550/8270C
1,3-Dichlorobenzene	U	U	µg/Kg	3.2	9.6	3550/8270C
1,4-Dichlorobenzene	U	U	µg/Kg	2.0	6.0	3550/8270C
Benzyl Alcohol	U	U	µg/Kg	3	9	3550/8270C
1,2-Dichlorobenzene	U	U	µg/Kg	3.5	10.5	3550/8270C
Bis (2-Chloroisopropyl) Ether	U	U	µg/Kg	47	141	3550/8270C
N-Nitrosodi-N-Propylamine	U	U	µg/Kg	24.0	72.0	3550/8270C
Hexachloroethane	U	U	µg/Kg	67	201	3550/8270C
Nitrobenzene	U	U	µg/Kg	38	114	3550/8270C
Isophorone	U	U	µg/Kg	76	228	3550/8270C
2-Nitrophenol	U	U	µg/Kg	78	234	3550/8270C
2,4-Dimethylphenol	U	U	µg/Kg	72	216	3550/8270C
Bis (2-Chloroethoxy)methane	U	U	µg/Kg	81	243	3550/8270C
2,4-Dichlorophenol	U	U	µg/Kg	59	177	3550/8270C
1,2,3-Trichlorobenzene	U	U	µg/Kg	32	96	3550/8270C
1,2,4-Trichlorobenzene	U	U	µg/Kg	42	126	3550/8270C
Naphthalene	U	U	µg/Kg	1	3	3550/8270C
Hexachlorobutadiene	U	U	µg/Kg	14	42	3550/8270C
4-Chloro-3-Methylphenol	U	U	µg/Kg	66	198	3550/8270C
1-Methylnaphthalene	U	U	µg/Kg	1	3	3550/8270C
2-Methylnaphthlene	U	U	µg/Kg	1	3	3550/8270C
Hexachlorocyclopentadiene	U	U	µg/Kg	41	123	3550/8270C
2,3,6-Trichlorophenol	U	U	µg/Kg	98	294	3550/8270C
2,4,5-Trichlorophenol	U	U	µg/Kg	60	180	3550/8270C
2,4,6-Trichlorophenol	U	U	µg/Kg	53	159	3550/8270C
2-Chloronaphthalene	U	U	µg/Kg	34	102	3550/8270C
Dimethyl Phthalate	U	U	µg/Kg	38	114	3550/8270C
Acenaphthylene	1.21	I	µg/Kg	2.0	6.0	3550/8270C
2,6-Dinitrotoluene	U	U	µg/Kg	26	78	3550/8270C
Acenaphthene	U	U	µg/Kg	1.3	3.9	3550/8270C

Petroleum Hydrocarbon Speciation Analysis (continued)						
PARAMETER	RESULT	QC	UNITS	MDL	PQL	METHOD
2,4-Dinitrotoluene	U	U	µg/Kg	41	123	3550/8270C
4-Nitrophenol	U	U	µg/Kg	37	111	3550/8270C
Diethyl Phthalate	U	U	µg/Kg	35	105	3550/8270C
Fluorene	U	U	µg/Kg	1.0	3.0	3550/8270C
4-Chlorophenyl Phenyl Ether	U	U	µg/Kg	45	135	3550/8270C
4,6-Dinitro-2-Methylphenol	U	U	µg/Kg	36	108	3550/8270C
N-Nitrosodiphenylamine	U	U	µg/Kg	51	153	3550/8270C
4-Bromophenyl Phenyl Ether	U	U	µg/Kg	38	114	3550/8270C
Hexachlorobenzene	U	U	µg/Kg	36	108	3550/8270C
Pentachlorophenol	U	U	µg/Kg	1.7	5.1	3550/8270C
Phenanthrene	8.83	I	µg/Kg	2	6	3550/8270C
Anthracene	2.22		µg/Kg	0.6	1.8	3550/8270C
Di-N-Butyl Phthalate	U	U	µg/Kg	34	102	3550/8270C
Fluoranthene	25.0	I	µg/Kg	1.6	4.8	3550/8270C
Benzidine	U	U	µg/Kg	33	99	3550/8270C
Pyrene	19.5		µg/Kg	2	6	3550/8270C
Butyl Benzyl Phthalate	U	U	µg/Kg	50	150	3550/8270C
Benzo(A)Anthracene	6.09	I	µg/Kg	1	3	3550/8270C
3,3-Dichlorobenzidine	U	U	µg/Kg	100	300	3550/8270C
Chrysene	5.41		µg/Kg	1	3	3550/8270C
Bis (2 Ethylhexyl) Phthalate	U	U	µg/Kg	39	117	3550/8270C
Di-N-Octyl Phthalate	U	U	µg/Kg	44	132	3550/8270C
Benzo(B)Fluoranthene	2.17	I	µg/Kg	1	3	3550/8270C
Benzo(K)Fluoranthene	U	U	µg/Kg	1	3	3550/8270C
Benzo(A)Pyrene	1.95	I	µg/Kg	1	3	3550/8270C
Indeno(1,2,3-CD)Pyrene	U	U	µg/Kg	2	6	3550/8270C
Dibenzo (A,H) Anthracene	U	U	µg/Kg	2	6	3550/8270C
Benzo(G,H,I)Perylene	U	U	µg/Kg	2	6	3550/8270C
Bis-2-ethylexyl Adipate	U	U	µg/Kg	33	99	3550/8270C
Aldrin	U	U	µg/Kg	1.0	3.0	3550/8270C
-BHC	U	U	µg/Kg	3.0	9.0	3550/8270C
-BHC	U	U	µg/Kg	3.0	9.0	3550/8270C
-BHC	U	U	µg/Kg	3.0	9.0	3550/8270C
-BHC (Lindane)	U	U	µg/Kg	1.0	3.0	3550/8270C
Clordane	U	U	µg/Kg	1.0	3.0	3550/8270C
4,4'-DDD	U	U	µg/Kg	2	6	3550/8270C
4,4'-DDE	U	U	µg/Kg	1.39	4017	3550/8270C
4,4'-DDT	U	U	µg/Kg	1.69	5.07	3550/8270C
Dieldrin	U	U	µg/Kg	0.840	2.520	3550/8270C
Endosulfan I	U	U	µg/Kg	1.100	3.300	3550/8270C
Endosulfan II	U	U	µg/Kg	1.60	4.80	3550/8270C
Endosulfan Sulfate	U	U	µg/Kg	1.70	5.10	3550/8270C
Endrin	U	U	µg/Kg	1.800	5.400	3550/8270C
Endrin Aldehyde	U	U	µg/Kg	1.900	5.700	3550/8270C
Heptachlor	U	U	µg/Kg	1.78	5.34	3550/8270C
Heptachlor Epoxide	U	U	µg/Kg	1.68	5.04	3550/8270C
Toxaphene	U	U	µg/Kg	1.90	5.70	3550/8270C
PCB-1016	U	U	µg/Kg	0.30	0.90	3550/8270C
PCB-1221	U	U	µg/Kg	0.30	0.90	3550/8270C
PCB-1232	U	U	µg/Kg	0.30	0.90	3550/8270C
PCB-1242	U	U	µg/Kg	0.30	0.90	3550/8270C

Petroleum Hydrocarbon Speciation Analysis (continued)						
PARAMETER	RESULT	QC	UNITS	MDL	PQL	METHOD
PCB-1248	U	U	µg/Kg	0.30	0.90	3550/8270C
PCB-1254	U	U	µg/Kg	0.30	0.90	3550/8270C
PCB-1260	U	U	µg/Kg	0.30	0.90	3550/8270C
Dioxin	U	U	µg/Kg	30	90	3550/8270C
Azobenzene	U	U	µg/Kg	30	90	3550/8270C
Methoxychlor	U	U	µg/Kg	19	57	3550/8270C
Benzoic Acid	U	U	µg/Kg	30	90	3550/8270C
Aniline	U	U	µg/Kg	30	90	3550/8270C
4-Chloroaniline	U	U	µg/Kg	11	33	3550/8270C
Dibenzofuran	U	U	µg/Kg	30	90	3550/8270C
2-Nitroaniline	U	U	µg/Kg	37	111	3550/8270C
30Nitroaniline	U	U	µg/Kg	30	90	3550/8270C
4-Nitroaniline	U	U	µg/Kg	30	90	3550/8270C
Carbazole	U	U	µg/Kg	30	90	3550/8270C
2,6-Dichlorophenol	U	U	µg/Kg	17	51	3550/8270C
2,3,4,6-Tetrachlorophenol	U	U	µg/Kg	30	90	3550/8270C
2,3,5,6-Tetrachlorophenol	U	U	µg/Kg	30	90	3550/8270C
Pyridine	U	U	µg/Kg	67	201	3550/8270C
FL-PRO (Petroleum Residual Organic Totals) Soil Dilution Factor = 1						
TOTAL PRO (C8-C40)	5.73		mg/Kg	0.01	0.03	FL-PRO
TPHCWG TPH-CWG Speciation Method (Soils) Dilution Factor = 1						
C5-C7 Aromatics	U	U	µg/Kg	5.0	15.0	TPHCWG
C7-C8 Aromatics	U	U	µg/Kg	5.0	15.0	TPHCWG
C8-C10 Aromatics	U	U	µg/Kg	5.0	15.0	TPHCWG
C10-C12 Aromatics	U	U	µg/Kg	5.0	15.0	TPHCWG
C12-C16 Aromatics	56.8	Q	µg/Kg	5.0	15.0	TPHCWG
C16-C21 Aromatics	15.6	Q	µg/Kg	5.0	15.0	TPHCWG
C21-C35 Aromatics	U	U	µg/Kg	5.0	15.0	TPHCWG
C5-C6 Aliphatics	U	U	µg/Kg	5.0	15.0	TPHCWG
C6-C8 Aliphatics	U	U	µg/Kg	5.0	15.0	TPHCWG
C8-C10 Aliphatics	U	U	µg/Kg	5.0	15.0	TPHCWG
C10-C12 Aliphatics	U	U	µg/Kg	5.0	15.0	TPHCWG
C12-C16 Aliphatics	U	U	µg/Kg	5.0	15.0	TPHCWG
C16-C35 Aliphatics	5,730	Q	µg/Kg	5.0	15.0	TPHCWG

QC=Qualifier Code as defined by DEP 62-160; U=Undetected; MDL=Minimum Detection Limit; PQL=Practical Quantation Limit.

BLIND PASS SEDIMENT CORE BP-31 (183-188 cm)

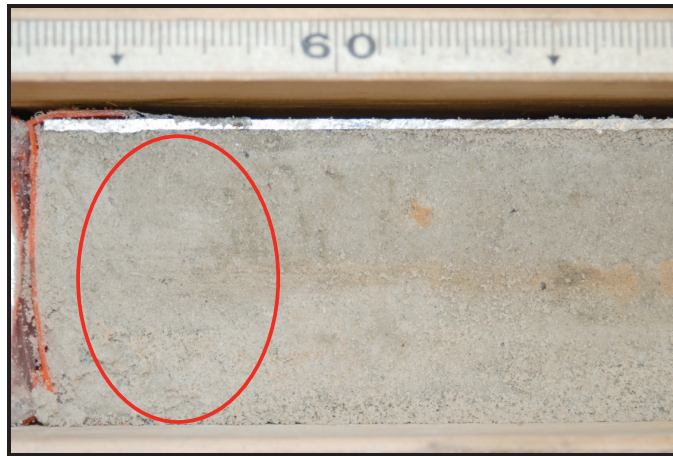

Red circle indicates area sampled for GC/MS analysis.

C₈-C₄₀ Table						
PARAMETER	RESULT	QC	UNITS	MDL	PQL	METHOD
Percent Solids	88.5		%	0.1	0.3	EPA 160.3
FL-PRO (Petroleum Residual Organic Totals) Soil Dilution Factor = 1						
TOTAL PRO (C8-C40)	2.57	U	mg/Kg	0.01	0.03	FL-PRO

QC=Qualifier Code as defined by DEP 62-160; U=Undetected; I=In between the MDL and PQL; Q= Out of hold; MDL=Minimum Detection Limit; PQL=Practical Quantation Limit.

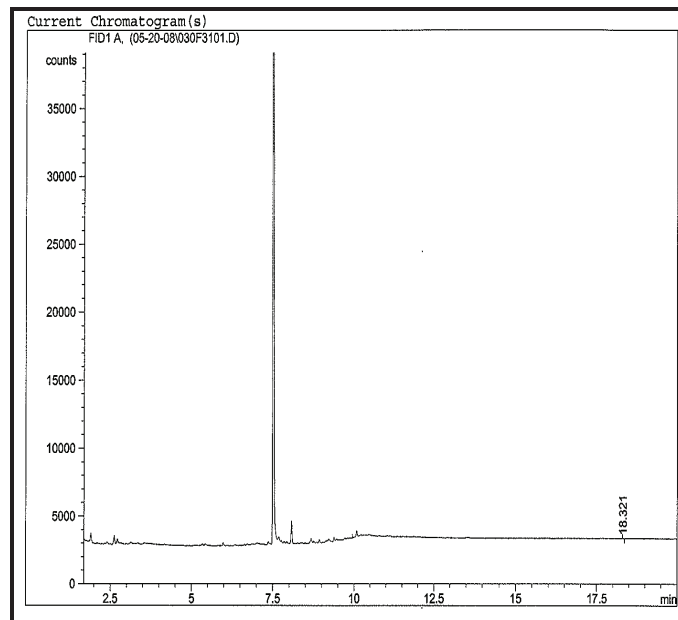

Chromatogram for sediment core BP-31 (183-188 cm).

Petroleum Hydrocarbon Speciation Analysis						
PARAMETER	RESULT	QC	UNITS	MDL	PQL	METHOD
Percent Solids	88.5		%	0.1	0.3	EPA 160.3
8260B VOA Compounds in Solids & Wastes GC/MS Dilution Factor = 1						
Methyl-tert-butyl-ether	U	U	µg/Kg	1.9	5.7	5030/8260B
Benzene	U	U	µg/Kg	0.85	2.55	5030/8260B
Toluene	U	U	µg/Kg	1.4	4.2	5030/8260B
Chlorobenzene	U	U	µg/Kg	2.3	6.9	5030/8260B
Ethylbenzene	U	U	µg/Kg	1.5	4.5	5030/8260B
M & p Xylene	U	U	µg/Kg	1.3	3.9	5030/8260B
o-Xylene	U	U	µg/Kg	1.1	3.3	5030/8260B
1,3-Dichlorobenzene	U	U	µg/Kg	3.2	9.6	5030/8260B
1,4-Dichlorobenzene	U	U	µg/Kg	2.0	6.0	5030/8260B
1,2-Dichlorobenzene	U	U	µg/Kg	3.5	10.5	5030/8260B
8270C Semivolatile Organics in Solids by GC/MS Dilution Factor = 1						
N-Nitrosodimethylamine	U	U	µg/Kg	69	207	3550/8270C
Phenol	U	U	µg/Kg	43	129	3550/8270C
2-Methyl Phenol (o-cresol)	U	U	µg/Kg	62	186	3550/8270C
3-Methyl Phenol (m-cresol)	U	U	µg/Kg	46	138	3550/8270C
4-Methyl Phenol (p-cresol)	U	U	µg/Kg	37	111	3550/8270C
Bis (2-Chloroethyl) Ether	U	U	µg/Kg	47	141	3550/8270C
2-Chlorophenol	U	U	µg/Kg	27.0	81.0	3550/8270C
1,3-Dichlorobenzene	U	U	µg/Kg	3.2	9.6	3550/8270C
1,4-Dichlorobenzene	U	U	µg/Kg	2.0	6.0	3550/8270C
Benzyl Alcohol	U	U	µg/Kg	3	9	3550/8270C
1,2-Dichlorobenzene	U	U	µg/Kg	3.5	10.5	3550/8270C
Bis (2-Chloroisopropyl) Ether	U	U	µg/Kg	47	141	3550/8270C
N-Nitrosodi-N-Proplamine	U	U	µg/Kg	24.0	72.0	3550/8270C
Hexachloroethane	U	U	µg/Kg	67	201	3550/8270C
Nitrobenzene	U	U	µg/Kg	38	114	3550/8270C
Isophorone	U	U	µg/Kg	76	228	3550/8270C
2-Nitrophenol	U	U	µg/Kg	78	234	3550/8270C
2,4-Dimethylphenol	U	U	µg/Kg	72	216	3550/8270C
Bis (2-Chloroethoxy)methane	U	U	µg/Kg	81	243	3550/8270C
2,4-Dichlorophenol	U	U	µg/Kg	59	177	3550/8270C
1,2,3-Trichlorobenzene	U	U	µg/Kg	32	96	3550/8270C
1,2,4-Trichlorobenzene	U	U	µg/Kg	42	126	3550/8270C
Naphthalene	U	U	µg/Kg	1	3	3550/8270C
Hexachlorobutadiene	U	U	µg/Kg	14	42	3550/8270C
4-Chloro-3-Methylphenol	U	U	µg/Kg	66	198	3550/8270C
1-Methylnaphthalene	U	U	µg/Kg	1	3	3550/8270C
2-Methylnaphthlene	U	U	µg/Kg	1	3	3550/8270C
Hexachlorocyclopentadiene	U	U	µg/Kg	41	123	3550/8270C
2,3,6-Trichlorophenol	U	U	µg/Kg	98	294	3550/8270C
2,4,5-Trichlorophenol	U	U	µg/Kg	60	180	3550/8270C
2,4,6-Trichlorophenol	U	U	µg/Kg	53	159	3550/8270C
2-Chloronaphthalene	U	U	µg/Kg	34	102	3550/8270C
Dimethyl Phthalate	U	U	µg/Kg	38	114	3550/8270C
Acenaphthylene	U	U	µg/Kg	2.0	6.0	3550/8270C
2,6-Dinitrotoluene	U	U	µg/Kg	26	78	3550/8270C
Acenaphthene	U	U	µg/Kg	1.3	3.9	3550/8270C
2,4-Dinitrophenol	U	U	µg/Kg	34	102	3550/8270C

Petroleum Hydrocarbon Speciation Analysis (continued)						
PARAMETER	RESULT	QC	UNITS	MDL	PQL	METHOD
2,4-Dinitrotoluene	U	U	µg/Kg	41	123	3550/8270C
4-Nitrophenol	U	U	µg/Kg	37	111	3550/8270C
Diethyl Phthalate	U	U	µg/Kg	35	105	3550/8270C
Fluorene	U	U	µg/Kg	1.0	3.0	3550/8270C
4-Chlorophenyl Phenyl Ether	U	U	µg/Kg	45	135	3550/8270C
4,6-Dinitro-2-Methylphenol	U	U	µg/Kg	36	108	3550/8270C
N-Nitrosodiphenylamine	U	U	µg/Kg	51	153	3550/8270C
4-Bromophenyl Phenyl Ether	U	U	µg/Kg	38	114	3550/8270C
Hexachlorobenzene	U	U	µg/Kg	36	108	3550/8270C
Pentachlorophenol	U	U	µg/Kg	1.7	5.1	3550/8270C
Phenanthrene	U	U	µg/Kg	2	6	3550/8270C
Anthracene	U	U	µg/Kg	0.6	1.8	3550/8270C
Di-N-Butyl Phthalate	U	U	µg/Kg	34	102	3550/8270C
Fluoranthene	4.25		µg/Kg	1.6	4.8	3550/8270C
Benzidine	U	U	µg/Kg	33	99	3550/8270C
Pyrene	3.03		µg/Kg	2	6	3550/8270C
Butyl Benzyl Phthalate	U	U	µg/Kg	50	150	3550/8270C
Benzo(A)Anthracene	1.99		µg/Kg	1	3	3550/8270C
3,3-Dichlorobenzidine	U	U	µg/Kg	100	300	3550/8270C
Chrysene	1.37		µg/Kg	1	3	3550/8270C
Bis (2 Ethylhexyl) Phthalate	U	U	µg/Kg	39	117	3550/8270C
Di-N-Octyl Phthalate	U	U	µg/Kg	44	132	3550/8270C
Benzo(B)Fluoranthene	2.23		µg/Kg	1	3	3550/8270C
Benzo(K)Fluoranthene	U	U	µg/Kg	1	3	3550/8270C
Benzo(A)Pyrene	1.41		µg/Kg	1	3	3550/8270C
Indeno(1,2,3-CD)Pyrene	U	U	µg/Kg	2	6	3550/8270C
Dibenzo (A,H) Anthracene	U	U	µg/Kg	2	6	3550/8270C
Benzo(G,H,I)Perylene	U	U	µg/Kg	2	6	3550/8270C
Bis-2-ethylexyl Adipate	U	U	µg/Kg	33	99	3550/8270C
Aldrin	U	U	µg/Kg	1.0	3.0	3550/8270C
-BHC	U	U	µg/Kg	3.0	9.0	3550/8270C
-BHC	U	U	µg/Kg	3.0	9.0	3550/8270C
-BHC	U	U	µg/Kg	3.0	9.0	3550/8270C
-BHC (Lindane)	U	U	µg/Kg	1.0	3.0	3550/8270C
Clordane	U	U	µg/Kg	1.0	3.0	3550/8270C
4,4'-DDD	U	U	µg/Kg	2	6	3550/8270C
4,4'-DDE	U	U	µg/Kg	1.39	4017	3550/8270C
4,4'-DDT	U	U	µg/Kg	1.69	5.07	3550/8270C
Dieldrin	U	U	µg/Kg	0.840	2.520	3550/8270C
Endosulfan I	U	U	µg/Kg	1.100	3.300	3550/8270C
Endosulfan II	U	U	µg/Kg	1.60	4.80	3550/8270C
Endosulfan Sulfate	U	U	µg/Kg	1.70	5.10	3550/8270C
Endrin	U	U	µg/Kg	1.800	5.400	3550/8270C
Endrin Aldehyde	U	U	µg/Kg	1.900	5.700	3550/8270C
Heptachlor	U	U	µg/Kg	1.78	5.34	3550/8270C
Heptachlor Epoxide	U	U	µg/Kg	1.68	5.04	3550/8270C
Toxaphene	U	U	µg/Kg	1.90	5.70	3550/8270C
PCB-1016	U	U	µg/Kg	0.30	0.90	3550/8270C
PCB-1221	U	U	µg/Kg	0.30	0.90	3550/8270C
PCB-1232	U	U	µg/Kg	0.30	0.90	3550/8270C
PCB-1242	U	U	µg/Kg	0.30	0.90	3550/8270C

Petroleum Hydrocarbon Speciation Analysis (continued)						
PARAMETER	RESULT	QC	UNITS	MDL	PQL	METHOD
PCB-1248	U	U	µg/Kg	0.30	0.90	3550/8270C
PCB-1254	U	U	µg/Kg	0.30	0.90	3550/8270C
PCB-1260	U	U	µg/Kg	0.30	0.90	3550/8270C
Dioxin	U	U	µg/Kg	30	90	3550/8270C
Azobenzene	U	U	µg/Kg	30	90	3550/8270C
Methoxychlor	U	U	µg/Kg	19	57	3550/8270C
Benzoic Acid	U	U	µg/Kg	30	90	3550/8270C
Aniline	U	U	µg/Kg	30	90	3550/8270C
4-Chloroaniline	U	U	µg/Kg	11	33	3550/8270C
Dibenzofuran	U	U	µg/Kg	30	90	3550/8270C
2-Nitroaniline	U	U	µg/Kg	37	111	3550/8270C
30Nitroaniline	U	U	µg/Kg	30	90	3550/8270C
4-Nitroaniline	U	U	µg/Kg	30	90	3550/8270C
Carbazole	U	U	µg/Kg	30	90	3550/8270C
2,6-Dichlorophenol	U	U	µg/Kg	17	51	3550/8270C
2,3,4,6-Tetrachlorophenol	U	U	µg/Kg	30	90	3550/8270C
2,3,5,6-Tetrachlorophenol	U	U	µg/Kg	30	90	3550/8270C
Pyridine	U	U	µg/Kg	67	201	3550/8270C
FL-PRO (Petroleum Residual Organic Totals) Soil Dilution Factor = 1						
TOTAL PRO (C8-C40)	2.57		mg/Kg	0.01	0.03	FL-PRO
TPHCWG TPH-CWG Speciation Method (Soils) Dilution Factor = 1						
C5-C7 Aromatics	U	U	µg/Kg	5.0	15.0	TPHCWG
C7-C8 Aromatics	U	U	µg/Kg	5.0	15.0	TPHCWG
C8-C10 Aromatics	U	U	µg/Kg	5.0	15.0	TPHCWG
C10-C12 Aromatics	U	U	µg/Kg	5.0	15.0	TPHCWG
C12-C16 Aromatics	U	U	µg/Kg	5.0	15.0	TPHCWG
C16-C21 Aromatics	12.8		µg/Kg	5.0	15.0	TPHCWG
C21-C35 Aromatics	U	U	µg/Kg	5.0	15.0	TPHCWG
C5-C6 Aliphatics	U	U	µg/Kg	5.0	15.0	TPHCWG
C6-C8 Aliphatics	U	U	µg/Kg	5.0	15.0	TPHCWG
C8-C10 Aliphatics	U	U	µg/Kg	5.0	15.0	TPHCWG
C10-C12 Aliphatics	U	U	µg/Kg	5.0	15.0	TPHCWG
C12-C16 Aliphatics	U	U	µg/Kg	5.0	15.0	TPHCWG
C16-C35 Aliphatics	2560		µg/Kg	5.0	15.0	TPHCWG

QC=Qualifier Code as defined by DEP 62-160; U=Undetected; MDL=Minimum Detection Limit; PQL=Practical Quantization Limit.

BLIND PASS SEDIMENT CORE BP-31 (214-219 cm)

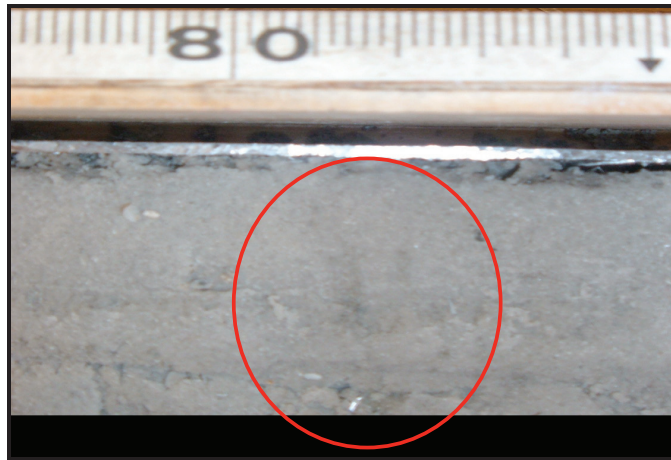

Red circle indicates area sampled for GC/MS.

C₈-C₄₀ Table						
PARAMETER	RESULT	QC	UNITS	MDL	PQL	METHOD
Percent Solids	82.1		%	0.1	0.3	EPA 160.3
FL-PRO (Petroleum Residual Organic Totals) Soil Dilution Factor = 1						
TOTAL PRO (C8-C40)	5.90	Q	mg/Kg	0.01	0.03	FL-PRO

QC=Qualifier Code as defined by DEP 62-160; U=Undetected; I=In between the MDL and PQL; Q= Out of hold; MDL=Minimum Detection Limit; PQL=Practical Quantation Limit.

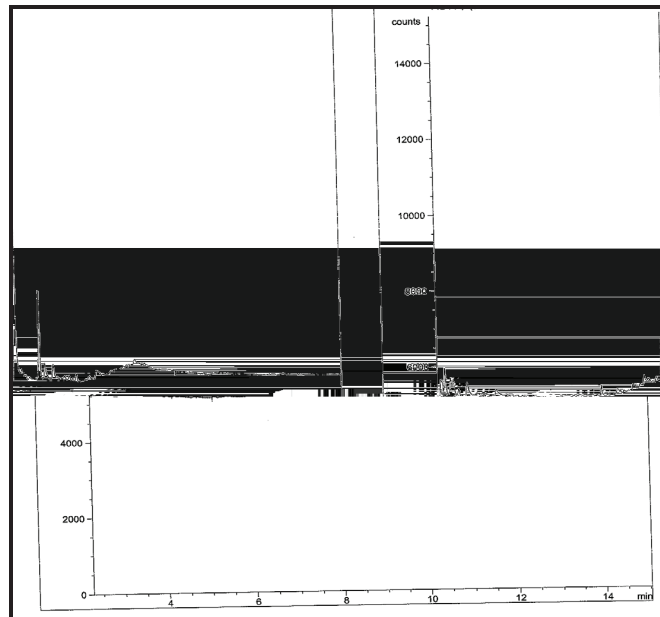

Chromatogram for sediment core BP-31 (214-219 cm).

Petroleum Hydrocarbon Speciation Analysis						
PARAMETER	RESULT	QC	UNITS	MDL	PQL	METHOD
Percent Solids	82.1		%	0.1	0.3	EPA 160.3
8260B VOA Compounds in Solids & Wastes GC/MS Dilution Factor = 1						
Methyl-tert-butyl-ether	2.20	Q	µg/Kg	0.7	2.1	5035/8260B
Methyl Ether Ketone	3.11	QI	µg/Kg	1.0	3.1	5035/8260B
Benzene	U	U	µg/Kg	0.5	1.6	5035/8260B
Toluene	U	U	µg/Kg	0.5	1.5	5035/8260B
Chlorobenzene	U	U	µg/Kg	0.7	2.1	5035/8260B
Ethylbenzene	U	U	µg/Kg	0.7	2.1	5035/8260B
M & p Xylene	U	U	µg/Kg	1.5	4.5	5035/8260B
o-Xylene	U	U	µg/Kg	0.7	2.1	5035/8260B
1,3-Dichlorobenzene	U	U	µg/Kg	1.0	3.0	5035/8260B
1,4-Dichlorobenzene	U	U	µg/Kg	0.8	2.4	5035/8260B
1,2-Dichlorobenzene	U	U	µg/Kg	0.7	2.1	5035/8260B
8270C Semivolatile Organics in Solids by GC/MS Dilution Factor = 1						
N-Nitrosodimethylamine	U	U	µg/Kg	69	207	3550/8270C
Phenol	U	U	µg/Kg	43	129	3550/8270C
2-Methyl Phenol (o-cresol)	U	U	µg/Kg	62	186	3550/8270C
3-Methyl Phenol (m-cresol)	U	U	µg/Kg	46	138	3550/8270C
4-Methyl Phenol (p-cresol)	U	U	µg/Kg	37	111	3550/8270C
Bis (2-Chloroethyl) Ether	U	U	µg/Kg	47	141	3550/8270C
2-Chlorophenol	U	U	µg/Kg	27.0	81.0	3550/8270C
1,3-Dichlorobenzene	U	U	µg/Kg	3.2	9.6	3550/8270C
1,4-Dichlorobenzene	U	U	µg/Kg	2.0	6.0	3550/8270C
Benzyl Alcohol	U	U	µg/Kg	3	9	3550/8270C
1,2-Dichlorobenzene	U	U	µg/Kg	3.5	10.5	3550/8270C
Bis (2-Chloroisopropyl) Ether	U	U	µg/Kg	47	141	3550/8270C
N-Nitrosodi-N-Propylamine	U	U	µg/Kg	24.0	72.0	3550/8270C
Hexachloroethane	U	U	µg/Kg	67	201	3550/8270C
Nitrobenzene	U	U	µg/Kg	38	114	3550/8270C
Isophorone	U	U	µg/Kg	76	228	3550/8270C
2-Nitrophenol	U	U	µg/Kg	78	234	3550/8270C
2,4-Dimethylphenol	U	U	µg/Kg	72	216	3550/8270C
Bis (2-Chloroethoxy)methane	U	U	µg/Kg	81	243	3550/8270C
2,4-Dichlorophenol	U	U	µg/Kg	59	177	3550/8270C
1,2,3-Trichlorobenzene	U	U	µg/Kg	32	96	3550/8270C
1,2,4-Trichlorobenzene	U	U	µg/Kg	42	126	3550/8270C
Naphthalene	U	U	µg/Kg	1	3	3550/8270C
Hexachlorobutadiene	U	U	µg/Kg	14	42	3550/8270C
4-Chloro-3-Methylphenol	U	U	µg/Kg	66	198	3550/8270C
1-Methylnaphthalene	U	U	µg/Kg	1	3	3550/8270C
2-Methylnaphthlene	U	U	µg/Kg	1	3	3550/8270C
Hexachlorocyclopentadiene	U	U	µg/Kg	41	123	3550/8270C
2,3,6-Trichlorophenol	U	U	µg/Kg	98	294	3550/8270C
2,4,5-Trichlorophenol	U	U	µg/Kg	60	180	3550/8270C
2,4,6-Trichlorophenol	U	U	µg/Kg	53	159	3550/8270C
2-Chloronaphthalene	U	U	µg/Kg	34	102	3550/8270C
Dimethyl Phthalate	U	U	µg/Kg	38	114	3550/8270C
Acenaphthylene	U	U	µg/Kg	2.0	6.0	3550/8270C
2,6-Dinitrotoluene	U	U	µg/Kg	26	78	3550/8270C
Acenaphthene	U	U	µg/Kg	1.3	3.9	3550/8270C

Petroleum Hydrocarbon Speciation Analysis (continued)						
PARAMETER	RESULT	QC	UNITS	MDL	PQL	METHOD
2,4-Dinitrotoluene	U	U	µg/Kg	41	123	3550/8270C
4-Nitrophenol	U	U	µg/Kg	37	111	3550/8270C
Diethyl Phthalate	U	U	µg/Kg	35	105	3550/8270C
Fluorene	U	U	µg/Kg	1.0	3.0	3550/8270C
4-Chlorophenyl Phenyl Ether	U	U	µg/Kg	45	135	3550/8270C
4,6-Dinitro-2-Methylphenol	U	U	µg/Kg	36	108	3550/8270C
N-Nitrosodiphenylamine	U	U	µg/Kg	51	153	3550/8270C
4-Bromophenyl Phenyl Ether	U	U	µg/Kg	38	114	3550/8270C
Hexachlorobenzene	U	U	µg/Kg	36	108	3550/8270C
Pentachlorophenol	U	U	µg/Kg	1.7	5.1	3550/8270C
Phenanthrene	3.02	I	µg/Kg	2	6	3550/8270C
Anthracene	U	U	µg/Kg	0.6	1.8	3550/8270C
Di-N-Butyl Phthalate	U	U	µg/Kg	34	102	3550/8270C
Fluoranthene	11.4		µg/Kg	1.6	4.8	3550/8270C
Benzidine	U	U	µg/Kg	33	99	3550/8270C
Pyrene	8.18		µg/Kg	2	6	3550/8270C
Butyl Benzyl Phthalate	U	U	µg/Kg	50	150	3550/8270C
Benzo(A)Anthracene	2.28	I	µg/Kg	1	3	3550/8270C
3,3-Dichlorobenzidine	U	U	µg/Kg	100	300	3550/8270C
Chrysene	1.80	I	µg/Kg	1	3	3550/8270C
Bis (2 Ethylhexyl) Phthalate	U	U	µg/Kg	39	117	3550/8270C
Di-N-Octyl Phthalate	U	U	µg/Kg	44	132	3550/8270C
Benzo(B)Fluoranthene	1.30	I	µg/Kg	1	3	3550/8270C
Benzo(K)Fluoranthene	U	U	µg/Kg	1	3	3550/8270C
Benzo(A)Pyrene	U	U	µg/Kg	1	3	3550/8270C
Indeno(1,2,3-CD)Pyrene	U	U	µg/Kg	2	6	3550/8270C
Dibenzo (A,H) Anthracene	U	U	µg/Kg	2	6	3550/8270C
Benzo(G,H,I)Perylene	U	U	µg/Kg	2	6	3550/8270C
Bis-2-ethylexyl Adipate	U	U	µg/Kg	33	99	3550/8270C
Aldrin	U	U	µg/Kg	1.0	3.0	3550/8270C
-BHC	U	U	µg/Kg	3.0	9.0	3550/8270C
-BHC	U	U	µg/Kg	3.0	9.0	3550/8270C
-BHC	U	U	µg/Kg	3.0	9.0	3550/8270C
-BHC (Lindane)	U	U	µg/Kg	1.0	3.0	3550/8270C
Clordane	U	U	µg/Kg	1.0	3.0	3550/8270C
4,4'-DDD	U	U	µg/Kg	2	6	3550/8270C
4,4'-DDE	U	U	µg/Kg	1.39	4017	3550/8270C
4,4'-DDT	U	U	µg/Kg	1.69	5.07	3550/8270C
Dieldrin	U	U	µg/Kg	0.840	2.520	3550/8270C
Endosulfan I	U	U	µg/Kg	1.100	3.300	3550/8270C
Endosulfan II	U	U	µg/Kg	1.60	4.80	3550/8270C
Endosulfan Sulfate	U	U	µg/Kg	1.70	5.10	3550/8270C
Endrin	U	U	µg/Kg	1.800	5.400	3550/8270C
Endrin Aldehyde	U	U	µg/Kg	1.900	5.700	3550/8270C
Heptachlor	U	U	µg/Kg	1.78	5.34	3550/8270C
Heptachlor Epoxide	U	U	µg/Kg	1.68	5.04	3550/8270C
Toxaphene	U	U	µg/Kg	1.90	5.70	3550/8270C
PCB-1016	U	U	µg/Kg	0.30	0.90	3550/8270C
PCB-1221	U	U	µg/Kg	0.30	0.90	3550/8270C
PCB-1232	U	U	µg/Kg	0.30	0.90	3550/8270C
PCB-1242	U	U	µg/Kg	0.30	0.90	3550/8270C

Petroleum Hydrocarbon Speciation Analysis (continued)						
PARAMETER	RESULT	QC	UNITS	MDL	PQL	METHOD
PCB-1248	U	U	µg/Kg	0.30	0.90	3550/8270C
PCB-1254	U	U	µg/Kg	0.30	0.90	3550/8270C
PCB-1260	U	U	µg/Kg	0.30	0.90	3550/8270C
Dioxin	U	U	µg/Kg	30	90	3550/8270C
Azobenzene	U	U	µg/Kg	30	90	3550/8270C
Methoxychlor	U	U	µg/Kg	19	57	3550/8270C
Benzoic Acid	U	U	µg/Kg	30	90	3550/8270C
Aniline	U	U	µg/Kg	30	90	3550/8270C
4-Chloroaniline	U	U	µg/Kg	11	33	3550/8270C
Dibenzofuran	U	U	µg/Kg	30	90	3550/8270C
2-Nitroaniline	U	U	µg/Kg	37	111	3550/8270C
30Nitroaniline	U	U	µg/Kg	30	90	3550/8270C
4-Nitroaniline	U	U	µg/Kg	30	90	3550/8270C
Carbazole	U	U	µg/Kg	30	90	3550/8270C
2,6-Dichlorophenol	U	U	µg/Kg	17	51	3550/8270C
2,3,4,6-Tetrachlorophenol	U	U	µg/Kg	30	90	3550/8270C
2,3,5,6-Tetrachlorophenol	U	U	µg/Kg	30	90	3550/8270C
Pyridine	U	U	µg/Kg	67	201	3550/8270C
FL-PRO (Petroleum Residual Organic Totals) Soil Dilution Factor = 1						
TOTAL PRO (C8-C40)	5.90		mg/Kg	0.01	0.03	FL-PRO
TPHCWG TPH-CWG Speciation Method (Soils) Dilution Factor = 1						
C5-C7 Aromatics	U	U	µg/Kg	5.0	15.0	TPHCWG
C7-C8 Aromatics	U	U	µg/Kg	5.0	15.0	TPHCWG
C8-C10 Aromatics	U	U	µg/Kg	5.0	15.0	TPHCWG
C10-C12 Aromatics	U	U	µg/Kg	5.0	15.0	TPHCWG
C12-C16 Aromatics	22.6	Q	µg/Kg	5.0	15.0	TPHCWG
C16-C21 Aromatics	5.38	QI	µg/Kg	5.0	15.0	TPHCWG
C21-C35 Aromatics	U	U	µg/Kg	5.0	15.0	TPHCWG
C5-C6 Aliphatics	U	U	µg/Kg	5.0	15.0	TPHCWG
C6-C8 Aliphatics	U	U	µg/Kg	5.0	15.0	TPHCWG
C8-C10 Aliphatics	U	U	µg/Kg	5.0	15.0	TPHCWG
C10-C12 Aliphatics	U	U	µg/Kg	5.0	15.0	TPHCWG
C12-C16 Aliphatics	U	U	µg/Kg	5.0	15.0	TPHCWG
C16-C35 Aliphatics	5,900	Q	µg/Kg	5.0	15.0	TPHCWG

QC=Qualifier Code as defined by DEP 62-160; U=Undetected; MDL=Minimum Detection Limit; PQL=Practical Quantation Limit.

BLIND PASS SEDIMENT CORE BP-31 (265-271 cm)

NO PHOTO

C₈-C₄₀ Table						
PARAMETER	RESULT	QC	UNITS	MDL	PQL	METHOD
Percent Solids	81.8		%	0.1	0.3	EPA 160.3
FL-PRO (Petroleum Residual Organic Totals) Soil Dilution Factor = 1						
TOTAL PRO (C8-C40)	9.77	Q	mg/Kg	0.01	0.03	FL-PRO

QC=Qualifier Code as defined by DEP 62-160; U=Undetected; I=In between the MDL and PQL; Q= Out of hold; MDL=Minimum Detection Limit; PQL=Practical Quantation Limit.

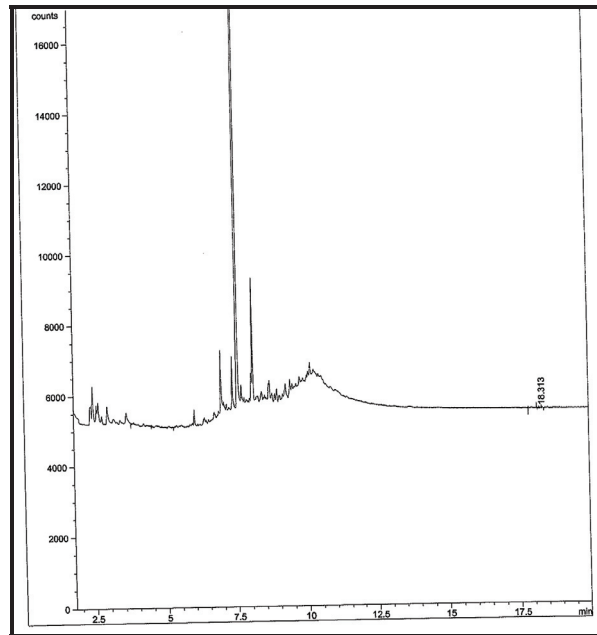

Chromatogram for sediment core BP-31 (265-271 cm).

Petroleum Hydrocarbon Speciation Analysis						
PARAMETER	RESULT	QC	UNITS	MDL	PQL	METHOD
Percent Solids	59.8		%	0.1	0.3	EPA 160.3
8260B VOA Compounds in Solids & Wastes GC/MS Dilution Factor = 1						
Methyl-tert-butyl-ether	2.18	Q	µg/Kg	0.7	2.1	5035/8260B
Methyl Ether Ketone	3.50	Q	µg/Kg	1.0	3.1	5035/8260B
Benzene	U	U	µg/Kg	0.5	1.6	5035/8260B
Toluene	U	U	µg/Kg	0.5	1.5	5035/8260B
Chlorobenzene	U	U	µg/Kg	0.7	2.1	5035/8260B
Ethylbenzene	U	U	µg/Kg	0.7	2.1	5035/8260B
M & p Xylene	U	U	µg/Kg	1.5	4.5	5035/8260B
o-Xylene	U	U	µg/Kg	0.7	2.1	5035/8260B
1,3-Dichlorobenzene	U	U	µg/Kg	1.0	3.0	5035/8260B
1,4-Dichlorobenzene	U	U	µg/Kg	0.8	2.4	5035/8260B
1,2-Dichlorobenzene	U	U	µg/Kg	0.7	2.1	5035/8260B
8270C Semivolatile Organics in Solids by GC/MS Dilution Factor = 1						
N-Nitrosodimethylamine	U	U	µg/Kg	69	207	3550/8270C
Phenol	U	U	µg/Kg	43	129	3550/8270C
2-Methyl Phenol (o-cresol)	U	U	µg/Kg	62	186	3550/8270C
3-Methyl Phenol (m-cresol)	U	U	µg/Kg	46	138	3550/8270C
4-Methyl Phenol (p-cresol)	U	U	µg/Kg	37	111	3550/8270C
Bis (2-Chloroethyl) Ether	U	U	µg/Kg	47	141	3550/8270C
2-Chlorophenol	U	U	µg/Kg	27.0	81.0	3550/8270C
1,3-Dichlorobenzene	U	U	µg/Kg	3.2	9.6	3550/8270C
1,4-Dichlorobenzene	U	U	µg/Kg	2.0	6.0	3550/8270C
Benzyl Alcohol	U	U	µg/Kg	3	9	3550/8270C
1,2-Dichlorobenzene	U	U	µg/Kg	3.5	10.5	3550/8270C
Bis (2-Chloroisopropyl) Ether	U	U	µg/Kg	47	141	3550/8270C
N-Nitrosodi-N-Propylamine	U	U	µg/Kg	24.0	72.0	3550/8270C
Hexachloroethane	U	U	µg/Kg	67	201	3550/8270C
Nitrobenzene	U	U	µg/Kg	38	114	3550/8270C
Isophorone	U	U	µg/Kg	76	228	3550/8270C
2-Nitrophenol	U	U	µg/Kg	78	234	3550/8270C
2,4-Dimethylphenol	U	U	µg/Kg	72	216	3550/8270C
Bis (2-Chloroethoxy)methane	U	U	µg/Kg	81	243	3550/8270C
2,4-Dichlorophenol	U	U	µg/Kg	59	177	3550/8270C
1,2,3-Trichlorobenzene	U	U	µg/Kg	32	96	3550/8270C
1,2,4-Trichlorobenzene	U	U	µg/Kg	42	126	3550/8270C
Naphthalene	U	U	µg/Kg	1	3	3550/8270C
Hexachlorobutadiene	U	U	µg/Kg	14	42	3550/8270C
4-Chloro-3-Methylphenol	U	U	µg/Kg	66	198	3550/8270C
1-Methylnaphthalene	U	U	µg/Kg	1	3	3550/8270C
2-Methylnaphthlene	U	U	µg/Kg	1	3	3550/8270C
Hexachlorocyclopentadiene	U	U	µg/Kg	41	123	3550/8270C
2,3,6-Trichlorophenol	U	U	µg/Kg	98	294	3550/8270C
2,4,5-Trichlorophenol	U	U	µg/Kg	60	180	3550/8270C
2,4,6-Trichlorophenol	U	U	µg/Kg	53	159	3550/8270C
2-Chloronaphthalene	U	U	µg/Kg	34	102	3550/8270C
Dimethyl Phthalate	U	U	µg/Kg	38	114	3550/8270C
Acenaphthylene	U	U	µg/Kg	2.0	6.0	3550/8270C
2,6-Dinitrotoluene	U	U	µg/Kg	26	78	3550/8270C
Acenaphthene	U	U	µg/Kg	1.3	3.9	3550/8270C

Petroleum Hydrocarbon Speciation Analysis (continued)						
PARAMETER	RESULT	QC	UNITS	MDL	PQL	METHOD
2,4-Dinitrotoluene	U	U	µg/Kg	41	123	3550/8270C
4-Nitrophenol	U	U	µg/Kg	37	111	3550/8270C
Diethyl Phthalate	U	U	µg/Kg	35	105	3550/8270C
Fluorene	U	U	µg/Kg	1.0	3.0	3550/8270C
4-Chlorophenyl Phenyl Ether	U	U	µg/Kg	45	135	3550/8270C
4,6-Dinitro-2-Methylphenol	U	U	µg/Kg	36	108	3550/8270C
N-Nitrosodiphenylamine	U	U	µg/Kg	51	153	3550/8270C
4-Bromophenyl Phenyl Ether	U	U	µg/Kg	38	114	3550/8270C
Hexachlorobenzene	U	U	µg/Kg	36	108	3550/8270C
Pentachlorophenol	U	U	µg/Kg	1.7	5.1	3550/8270C
Phenanthrene	4.10	I	µg/Kg	2	6	3550/8270C
Anthracene	1.09	I	µg/Kg	0.6	1.8	3550/8270C
Di-N-Butyl Phthalate	U	U	µg/Kg	34	102	3550/8270C
Fluoranthene	20.1		µg/Kg	1.6	4.8	3550/8270C
Benzidine	U	U	µg/Kg	33	99	3550/8270C
Pyrene	16.5		µg/Kg	2	6	3550/8270C
Butyl Benzyl Phthalate	U	U	µg/Kg	50	150	3550/8270C
Benzo(A)Anthracene	6.91		µg/Kg	1	3	3550/8270C
3,3-Dichlorobenzidine	U	U	µg/Kg	100	300	3550/8270C
Chrysene	4.07		µg/Kg	1	3	3550/8270C
Bis (2 Ethylhexyl) Phthalate	U	U	µg/Kg	39	117	3550/8270C
Di-N-Octyl Phthalate	U	U	µg/Kg	44	132	3550/8270C
Benzo(B)Fluoranthene	2.37	I	µg/Kg	1	3	3550/8270C
Benzo(K)Fluoranthene	U	U	µg/Kg	1	3	3550/8270C
Benzo(A)Pyrene	2.04	I	µg/Kg	1	3	3550/8270C
Indeno(1,2,3-CD)Pyrene	U	U	µg/Kg	2	6	3550/8270C
Dibenzo (A,H) Anthracene	U	U	µg/Kg	2	6	3550/8270C
Benzo(G,H,I)Perylene	U	U	µg/Kg	2	6	3550/8270C
Bis-2-ethylexyl Adipate	U	U	µg/Kg	33	99	3550/8270C
Aldrin	U	U	µg/Kg	1.0	3.0	3550/8270C
-BHC	U	U	µg/Kg	3.0	9.0	3550/8270C
-BHC	U	U	µg/Kg	3.0	9.0	3550/8270C
-BHC	U	U	µg/Kg	3.0	9.0	3550/8270C
-BHC (Lindane)	U	U	µg/Kg	1.0	3.0	3550/8270C
Clordane	U	U	µg/Kg	1.0	3.0	3550/8270C
4,4'-DDD	U	U	µg/Kg	2	6	3550/8270C
4,4'-DDE	U	U	µg/Kg	1.39	4017	3550/8270C
4,4'-DDT	U	U	µg/Kg	1.69	5.07	3550/8270C
Dieldrin	U	U	µg/Kg	0.840	2.520	3550/8270C
Endosulfan I	U	U	µg/Kg	1.100	3.300	3550/8270C
Endosulfan II	U	U	µg/Kg	1.60	4.80	3550/8270C
Endosulfan Sulfate	U	U	µg/Kg	1.70	5.10	3550/8270C
Endrin	U	U	µg/Kg	1.800	5.400	3550/8270C
Endrin Aldehyde	U	U	µg/Kg	1.900	5.700	3550/8270C
Heptachlor	U	U	µg/Kg	1.78	5.34	3550/8270C
Heptachlor Epoxide	U	U	µg/Kg	1.68	5.04	3550/8270C
Toxaphene	U	U	µg/Kg	1.90	5.70	3550/8270C
PCB-1016	U	U	µg/Kg	0.30	0.90	3550/8270C
PCB-1221	U	U	µg/Kg	0.30	0.90	3550/8270C
PCB-1232	U	U	µg/Kg	0.30	0.90	3550/8270C
PCB-1242	U	U	µg/Kg	0.30	0.90	3550/8270C

Petroleum Hydrocarbon Speciation Analysis (continued)						
PARAMETER	RESULT	QC	UNITS	MDL	PQL	METHOD
PCB-1248	U	U	µg/Kg	0.30	0.90	3550/8270C
PCB-1254	U	U	µg/Kg	0.30	0.90	3550/8270C
PCB-1260	U	U	µg/Kg	0.30	0.90	3550/8270C
Dioxin	U	U	µg/Kg	30	90	3550/8270C
Azobenzene	U	U	µg/Kg	30	90	3550/8270C
Methoxychlor	U	U	µg/Kg	19	57	3550/8270C
Benzoic Acid	U	U	µg/Kg	30	90	3550/8270C
Aniline	U	U	µg/Kg	30	90	3550/8270C
4-Chloroaniline	U	U	µg/Kg	11	33	3550/8270C
Dibenzofuran	U	U	µg/Kg	30	90	3550/8270C
2-Nitroaniline	U	U	µg/Kg	37	111	3550/8270C
30Nitroaniline	U	U	µg/Kg	30	90	3550/8270C
4-Nitroaniline	U	U	µg/Kg	30	90	3550/8270C
Carbazole	U	U	µg/Kg	30	90	3550/8270C
2,6-Dichlorophenol	U	U	µg/Kg	17	51	3550/8270C
2,3,4,6-Tetrachlorophenol	U	U	µg/Kg	30	90	3550/8270C
2,3,5,6-Tetrachlorophenol	U	U	µg/Kg	30	90	3550/8270C
Pyridine	U	U	µg/Kg	67	201	3550/8270C
FL-PRO (Petroleum Residual Organic Totals) Soil Dilution Factor = 1						
TOTAL PRO (C8-C40)	9.77		mg/Kg	0.01	0.03	FL-PRO
TPHCWG TPH-CWG Speciation Method (Soils) Dilution Factor = 1						
C5-C7 Aromatics	U	U	µg/Kg	5.0	15.0	TPHCWG
C7-C8 Aromatics	U	U	µg/Kg	5.0	15.0	TPHCWG
C8-C10 Aromatics	U	U	µg/Kg	5.0	15.0	TPHCWG
C10-C12 Aromatics	U	U	µg/Kg	5.0	15.0	TPHCWG
C12-C16 Aromatics	41.8	Q	µg/Kg	5.0	15.0	TPHCWG
C16-C21 Aromatics	15.4	Q	µg/Kg	5.0	15.0	TPHCWG
C21-C35 Aromatics	U	U	µg/Kg	5.0	15.0	TPHCWG
C5-C6 Aliphatics	U	U	µg/Kg	5.0	15.0	TPHCWG
C6-C8 Aliphatics	U	U	µg/Kg	5.0	15.0	TPHCWG
C8-C10 Aliphatics	U	U	µg/Kg	5.0	15.0	TPHCWG
C10-C12 Aliphatics	U	U	µg/Kg	5.0	15.0	TPHCWG
C12-C16 Aliphatics	U	U	µg/Kg	5.0	15.0	TPHCWG
C16-C35 Aliphatics	9,770	QI	µg/Kg	5.0	15.0	TPHCWG

QC=Qualifier Code as defined by DEP 62-160; U=Undetected; MDL=Minimum Detection Limit; PQL=Practical Quantation Limit.

BLIND PASS SEDIMENT CORE BP-24 (116-121 cm)

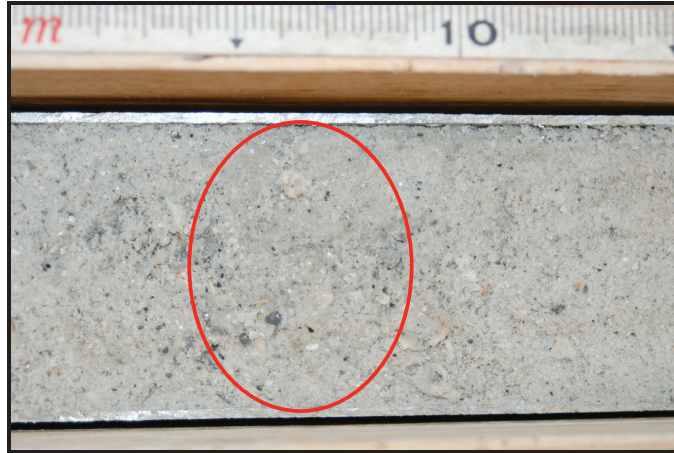

Red circle indicates area sampled for GC/MS analysis.

C₈-C₄₀ Table						
PARAMETER	RESULT	QC	UNITS	MDL	PQL	METHOD
Percent Solids	91.2		%	0.1	0.3	EPA 160.3
FL-PRO (Petroleum Residual Organic Totals) Soil Dilution Factor = 1						
TOTAL PRO (C8-C40)	5.68	U	mg/Kg	0.01	0.03	FL-PRO

QC=Qualifier Code as defined by DEP 62-160; U=Undetected; I=In between the MDL and PQL; Q= Out of hold; MDL=Minimum Detection Limit; PQL=Practical Quantation Limit.

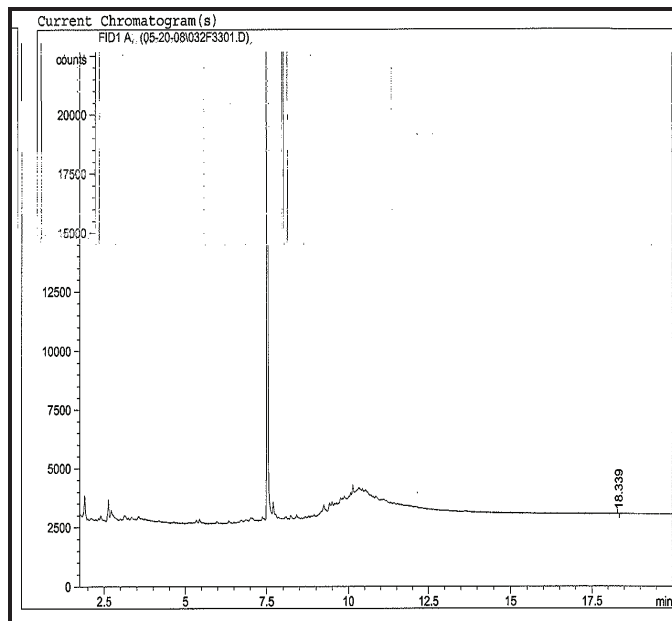

Chromatogram for sediment core BP-24 (116-121 cm).

Petroleum Hydrocarbon Speciation Analysis						
PARAMETER	RESULT	QC	UNITS	MDL	PQL	METHOD
Percent Solids	91.2		%	0.1	0.3	EPA 160.3
8260B VOA Compounds in Solids & Wastes GC/MS Dilution Factor = 1						
Methyl-tert-butyl-ether	U	U	µg/Kg	1.9	5.7	5030/8260B
Benzene	U	U	µg/Kg	0.85	2.55	5030/8260B
Toluene	U	U	µg/Kg	1.4	4.2	5030/8260B
Chlorobenzene	U	U	µg/Kg	2.3	6.9	5030/8260B
Ethylbenzene	U	U	µg/Kg	1.5	4.5	5030/8260B
M & p Xylene	U	U	µg/Kg	1.3	3.9	5030/8260B
o-Xylene	U	U	µg/Kg	1.1	3.3	5030/8260B
1,3-Dichlorobenzene	U	U	µg/Kg	3.2	9.6	5030/8260B
1,4-Dichlorobenzene	U	U	µg/Kg	2.0	6.0	5030/8260B
1,2-Dichlorobenzene	U	U	µg/Kg	3.5	10.5	5030/8260B
8270C Semivolatile Organics in Solids by GC/MS Dilution Factor = 1						
N-Nitrosodimethylamine	U	U	µg/Kg	69	207	3550/8270C
Phenol	U	U	µg/Kg	43	129	3550/8270C
2-Methyl Phenol (o-cresol)	U	U	µg/Kg	62	186	3550/8270C
3-Methyl Phenol (m-cresol)	U	U	µg/Kg	46	138	3550/8270C
4-Methyl Phenol (p-cresol)	U	U	µg/Kg	37	111	3550/8270C
Bis (2-Chloroethyl) Ether	U	U	µg/Kg	47	141	3550/8270C
2-Chlorophenol	U	U	µg/Kg	27.0	81.0	3550/8270C
1,3-Dichlorobenzene	U	U	µg/Kg	3.2	9.6	3550/8270C
1,4-Dichlorobenzene	U	U	µg/Kg	2.0	6.0	3550/8270C
Benzyl Alcohol	U	U	µg/Kg	3	9	3550/8270C
1,2-Dichlorobenzene	U	U	µg/Kg	3.5	10.5	3550/8270C
Bis (2-Chloroisopropyl) Ether	U	U	µg/Kg	47	141	3550/8270C
N-Nitrosodi-N-Proplamine	U	U	µg/Kg	24.0	72.0	3550/8270C
Hexachloroethane	U	U	µg/Kg	67	201	3550/8270C
Nitrobenzene	U	U	µg/Kg	38	114	3550/8270C
Isophorone	U	U	µg/Kg	76	228	3550/8270C
2-Nitrophenol	U	U	µg/Kg	78	234	3550/8270C
2,4-Dimethylphenol	U	U	µg/Kg	72	216	3550/8270C
Bis (2-Chloroethoxy)methane	U	U	µg/Kg	81	243	3550/8270C
2,4-Dichlorophenol	U	U	µg/Kg	59	177	3550/8270C
1,2,3-Trichlorobenzene	U	U	µg/Kg	32	96	3550/8270C
1,2,4-Trichlorobenzene	U	U	µg/Kg	42	126	3550/8270C
Naphthalene	U	U	µg/Kg	1	3	3550/8270C
Hexachlorobutadiene	U	U	µg/Kg	14	42	3550/8270C
4-Chloro-3-Methylphenol	U	U	µg/Kg	66	198	3550/8270C
1-Methylnaphthalene	U	U	µg/Kg	1	3	3550/8270C
2-Methylnaphthlene	U	U	µg/Kg	1	3	3550/8270C
Hexachlorocyclopentadiene	U	U	µg/Kg	41	123	3550/8270C
2,3,6-Trichlorophenol	U	U	µg/Kg	98	294	3550/8270C
2,4,5-Trichlorophenol	U	U	µg/Kg	60	180	3550/8270C
2,4,6-Trichlorophenol	U	U	µg/Kg	53	159	3550/8270C
2-Chloronaphthalene	U	U	µg/Kg	34	102	3550/8270C
Dimethyl Phthalate	U	U	µg/Kg	38	114	3550/8270C
Acenaphthylene	U	U	µg/Kg	2.0	6.0	3550/8270C
2,6-Dinitrotoluene	U	U	µg/Kg	26	78	3550/8270C
Acenaphthene	U	U	µg/Kg	1.3	3.9	3550/8270C
2,4-Dinitrophenol	U	U	µg/Kg	34	102	3550/8270C

Petroleum Hydrocarbon Speciation Analysis (continued)						
PARAMETER	RESULT	QC	UNITS	MDL	PQL	METHOD
2,4-Dinitrotoluene	U	U	µg/Kg	41	123	3550/8270C
4-Nitrophenol	U	U	µg/Kg	37	111	3550/8270C
Diethyl Phthalate	U	U	µg/Kg	35	105	3550/8270C
Fluorene	U	U	µg/Kg	1.0	3.0	3550/8270C
4-Chlorophenyl Phenyl Ether	U	U	µg/Kg	45	135	3550/8270C
4,6-Dinitro-2-Methylphenol	U	U	µg/Kg	36	108	3550/8270C
N-Nitrosodiphenylamine	U	U	µg/Kg	51	153	3550/8270C
4-Bromophenyl Phenyl Ether	U	U	µg/Kg	38	114	3550/8270C
Hexachlorobenzene	U	U	µg/Kg	36	108	3550/8270C
Pentachlorophenol	U	U	µg/Kg	1.7	5.1	3550/8270C
Phenanthrene	U	U	µg/Kg	2	6	3550/8270C
Anthracene	U	U	µg/Kg	0.6	1.8	3550/8270C
Di-N-Butyl Phthalate	U	U	µg/Kg	34	102	3550/8270C
Fluoranthene	U	U	µg/Kg	1.6	4.8	3550/8270C
Benzidine	U	U	µg/Kg	33	99	3550/8270C
Pyrene	U	U	µg/Kg	2	6	3550/8270C
Butyl Benzyl Phthalate	U	U	µg/Kg	50	150	3550/8270C
Benzo(A)Anthracene	U	U	µg/Kg	1	3	3550/8270C
3,3-Dichlorobenzidine	U	U	µg/Kg	100	300	3550/8270C
Chrysene	U	U	µg/Kg	1	3	3550/8270C
Bis (2 Ethylhexyl) Phthalate	U	U	µg/Kg	39	117	3550/8270C
Di-N-Octyl Phthalate	U	U	µg/Kg	44	132	3550/8270C
Benzo(B)Fluoranthene	U	U	µg/Kg	1	3	3550/8270C
Benzo(K)Fluoranthene	U	U	µg/Kg	1	3	3550/8270C
Benzo(A)Pyrene	U	U	µg/Kg	1	3	3550/8270C
Indeno(1,2,3-CD)Pyrene	U	U	µg/Kg	2	6	3550/8270C
Dibenzo (A,H) Anthracene	U	U	µg/Kg	2	6	3550/8270C
Benzo(G,H,I)Perylene	U	U	µg/Kg	2	6	3550/8270C
Bis-2-ethylexyl Adipate	U	U	µg/Kg	33	99	3550/8270C
Aldrin	U	U	µg/Kg	1.0	3.0	3550/8270C
-BHC	U	U	µg/Kg	3.0	9.0	3550/8270C
-BHC	U	U	µg/Kg	3.0	9.0	3550/8270C
-BHC	U	U	µg/Kg	3.0	9.0	3550/8270C
-BHC (Lindane)	U	U	µg/Kg	1.0	3.0	3550/8270C
Clordane	U	U	µg/Kg	1.0	3.0	3550/8270C
4,4'-DDD	U	U	µg/Kg	2	6	3550/8270C
4,4'-DDE	U	U	µg/Kg	1.39	4017	3550/8270C
4,4'-DDT	U	U	µg/Kg	1.69	5.07	3550/8270C
Dieldrin	U	U	µg/Kg	0.840	2.520	3550/8270C
Endosulfan I	U	U	µg/Kg	1.100	3.300	3550/8270C
Endosulfan II	U	U	µg/Kg	1.60	4.80	3550/8270C
Endosulfan Sulfate	U	U	µg/Kg	1.70	5.10	3550/8270C
Endrin	U	U	µg/Kg	1.800	5.400	3550/8270C
Endrin Aldehyde	U	U	µg/Kg	1.900	5.700	3550/8270C
Heptachlor	U	U	µg/Kg	1.78	5.34	3550/8270C
Heptachlor Epoxide	U	U	µg/Kg	1.68	5.04	3550/8270C
Toxaphene	U	U	µg/Kg	1.90	5.70	3550/8270C
PCB-1016	U	U	µg/Kg	0.30	0.90	3550/8270C
PCB-1221	U	U	µg/Kg	0.30	0.90	3550/8270C
PCB-1232	U	U	µg/Kg	0.30	0.90	3550/8270C
PCB-1242	U	U	µg/Kg	0.30	0.90	3550/8270C

Petroleum Hydrocarbon Speciation Analysis (continued)						
PARAMETER	RESULT	QC	UNITS	MDL	PQL	METHOD
PCB-1248	U	U	µg/Kg	0.30	0.90	3550/8270C
PCB-1254	U	U	µg/Kg	0.30	0.90	3550/8270C
PCB-1260	U	U	µg/Kg	0.30	0.90	3550/8270C
Dioxin	U	U	µg/Kg	30	90	3550/8270C
Azobenzene	U	U	µg/Kg	30	90	3550/8270C
Methoxychlor	U	U	µg/Kg	19	57	3550/8270C
Benzoic Acid	U	U	µg/Kg	30	90	3550/8270C
Aniline	U	U	µg/Kg	30	90	3550/8270C
4-Chloroaniline	U	U	µg/Kg	11	33	3550/8270C
Dibenzofuran	U	U	µg/Kg	30	90	3550/8270C
2-Nitroaniline	U	U	µg/Kg	37	111	3550/8270C
30Nitroaniline	U	U	µg/Kg	30	90	3550/8270C
4-Nitroaniline	U	U	µg/Kg	30	90	3550/8270C
Carbazole	U	U	µg/Kg	30	90	3550/8270C
2,6-Dichlorophenol	U	U	µg/Kg	17	51	3550/8270C
2,3,4,6-Tetrachlorophenol	U	U	µg/Kg	30	90	3550/8270C
2,3,5,6-Tetrachlorophenol	U	U	µg/Kg	30	90	3550/8270C
Pyridine	U	U	µg/Kg	67	201	3550/8270C
FL-PRO (Petroleum Residual Organic Totals) Soil Dilution Factor = 1						
TOTAL PRO (C8-C40)	5.68		mg/Kg	0.01	0.03	FL-PRO
TPHCWG TPH-CWG Speciation Method (Soils) Dilution Factor = 1						
C5-C7 Aromatics	U	U	µg/Kg	5.0	15.0	TPHCWG
C7-C8 Aromatics	U	U	µg/Kg	5.0	15.0	TPHCWG
C8-C10 Aromatics	U	U	µg/Kg	5.0	15.0	TPHCWG
C10-C12 Aromatics	U	U	µg/Kg	5.0	15.0	TPHCWG
C12-C16 Aromatics	U	U	µg/Kg	5.0	15.0	TPHCWG
C16-C21 Aromatics	U	U	µg/Kg	5.0	15.0	TPHCWG
C21-C35 Aromatics	U	U	µg/Kg	5.0	15.0	TPHCWG
C5-C6 Aliphatics	U	U	µg/Kg	5.0	15.0	TPHCWG
C6-C8 Aliphatics	U	U	µg/Kg	5.0	15.0	TPHCWG
C8-C10 Aliphatics	U	U	µg/Kg	5.0	15.0	TPHCWG
C10-C12 Aliphatics	U	U	µg/Kg	5.0	15.0	TPHCWG
C12-C16 Aliphatics	U	U	µg/Kg	5.0	15.0	TPHCWG
C16-C35 Aliphatics	5650		µg/Kg	5.0	15.0	TPHCWG

QC=Qualifier Code as defined by DEP 62-160; U=Undetected; MDL=Minimum Detection Limit; PQL=Practical Quantization Limit.

BLIND PASS SEDIMENT CORE BP-24 (293-294 cm)

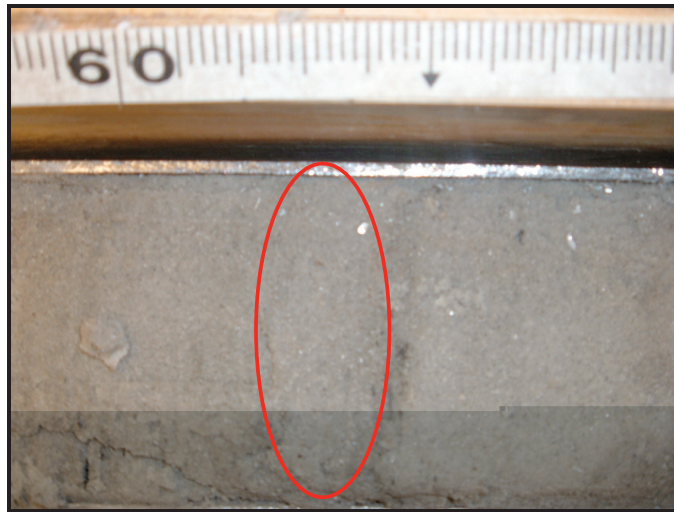

Red circle indicates area sampled for GC/MS.

C₈-C₄₀ Table						
PARAMETER	RESULT	QC	UNITS	MDL	PQL	METHOD
Percent Solids	78.9		%	0.1	0.3	EPA 160.3
FL-PRO (Petroleum Residual Organic Totals) Soil Dilution Factor = 1						
TOTAL PRO (C8-C40)	21.7	Q	mg/Kg	0.01	0.03	FL-PRO

QC=Qualifier Code as defined by DEP 62-160; U=Undetected; I=In between the MDL and PQL; Q= Out of hold; MDL=Minimum Detection Limit; PQL=Practical Quantation Limit.

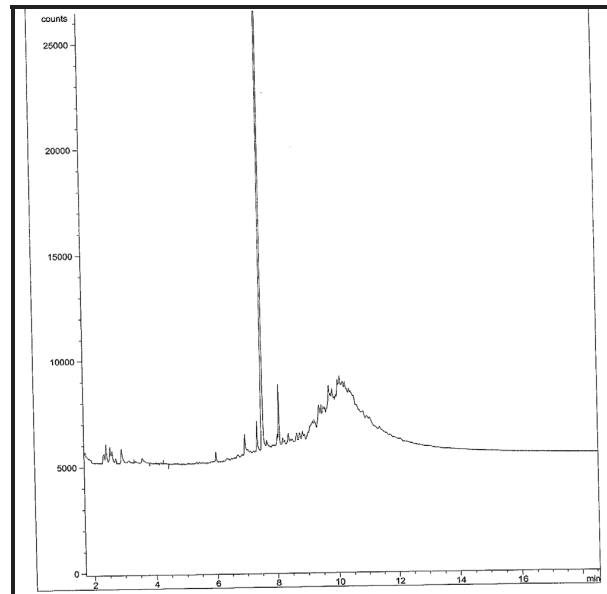

Chromatogram for sediment core BP-24 (293-294 cm).

Petroleum Hydrocarbon Speciation Analysis						
PARAMETER	RESULT	QC	UNITS	MDL	PQL	METHOD
Percent Solids	78.9		%	0.1	0.3	EPA 160.3
8260B VOA Compounds in Solids & Wastes GC/MS Dilution Factor = 1						
Methyl-tert-butyl-ether	2.36	Q	µg/Kg	0.7	2.1	5035/8260B
Methyl Ether Ketone	2.88	QI	µg/Kg	1.0	3.1	5035/8260B
Benzene	U	U	µg/Kg	0.5	1.6	5035/8260B
Toluene	U	U	µg/Kg	0.5	1.5	5035/8260B
Chlorobenzene	U	U	µg/Kg	0.7	2.1	5035/8260B
Ethylbenzene	U	U	µg/Kg	0.7	2.1	5035/8260B
M & p Xylene	U	U	µg/Kg	1.5	4.5	5035/8260B
o-Xylene	U	U	µg/Kg	0.7	2.1	5035/8260B
1,3-Dichlorobenzene	U	U	µg/Kg	1.0	3.0	5035/8260B
1,4-Dichlorobenzene	U	U	µg/Kg	0.8	2.4	5035/8260B
1,2-Dichlorobenzene	U	U	µg/Kg	0.7	2.1	5035/8260B
8270C Semivolatile Organics in Solids by GC/MS Dilution Factor = 1						
N-Nitrosodimethylamine	U	U	µg/Kg	69	207	3550/8270C
Phenol	U	U	µg/Kg	43	129	3550/8270C
2-Methyl Phenol (o-cresol)	U	U	µg/Kg	62	186	3550/8270C
3-Methyl Phenol (m-cresol)	U	U	µg/Kg	46	138	3550/8270C
4-Methyl Phenol (p-cresol)	U	U	µg/Kg	37	111	3550/8270C
Bis (2-Chloroethyl) Ether	U	U	µg/Kg	47	141	3550/8270C
2-Chlorophenol	U	U	µg/Kg	27.0	81.0	3550/8270C
1,3-Dichlorobenzene	U	U	µg/Kg	3.2	9.6	3550/8270C
1,4-Dichlorobenzene	U	U	µg/Kg	2.0	6.0	3550/8270C
Benzyl Alcohol	U	U	µg/Kg	3	9	3550/8270C
1,2-Dichlorobenzene	U	U	µg/Kg	3.5	10.5	3550/8270C
Bis (2-Chloroisopropyl) Ether	U	U	µg/Kg	47	141	3550/8270C
N-Nitrosodi-N-Propylamine	U	U	µg/Kg	24.0	72.0	3550/8270C
Hexachloroethane	U	U	µg/Kg	67	201	3550/8270C
Nitrobenzene	U	U	µg/Kg	38	114	3550/8270C
Isophorone	U	U	µg/Kg	76	228	3550/8270C
2-Nitrophenol	U	U	µg/Kg	78	234	3550/8270C
2,4-Dimethylphenol	U	U	µg/Kg	72	216	3550/8270C
Bis (2-Chloroethoxy)methane	U	U	µg/Kg	81	243	3550/8270C
2,4-Dichlorophenol	U	U	µg/Kg	59	177	3550/8270C
1,2,3-Trichlorobenzene	U	U	µg/Kg	32	96	3550/8270C
1,2,4-Trichlorobenzene	U	U	µg/Kg	42	126	3550/8270C
Naphthalene	U	U	µg/Kg	1	3	3550/8270C
Hexachlorobutadiene	U	U	µg/Kg	14	42	3550/8270C
4-Chloro-3-Methylphenol	U	U	µg/Kg	66	198	3550/8270C
1-Methylnaphthalene	U	U	µg/Kg	1	3	3550/8270C
2-Methylnaphthlene	U	U	µg/Kg	1	3	3550/8270C
Hexachlorocyclopentadiene	U	U	µg/Kg	41	123	3550/8270C
2,3,6-Trichlorophenol	U	U	µg/Kg	98	294	3550/8270C
2,4,5-Trichlorophenol	U	U	µg/Kg	60	180	3550/8270C
2,4,6-Trichlorophenol	U	U	µg/Kg	53	159	3550/8270C
2-Chloronaphthalene	U	U	µg/Kg	34	102	3550/8270C
Dimethyl Phthalate	U	U	µg/Kg	38	114	3550/8270C
Acenaphthylene	U	U	µg/Kg	2.0	6.0	3550/8270C
2,6-Dinitrotoluene	U	U	µg/Kg	26	78	3550/8270C
Acenaphthene	1.80	I	µg/Kg	1.3	3.9	3550/8270C

Petroleum Hydrocarbon Speciation Analysis (continued)						
PARAMETER	RESULT	QC	UNITS	MDL	PQL	METHOD
2,4-Dinitrotoluene	U	U	µg/Kg	41	123	3550/8270C
4-Nitrophenol	U	U	µg/Kg	37	111	3550/8270C
Diethyl Phthalate	U	U	µg/Kg	35	105	3550/8270C
Fluorene	1.60	I	µg/Kg	1.0	3.0	3550/8270C
4-Chlorophenyl Phenyl Ether	U	U	µg/Kg	45	135	3550/8270C
4,6-Dinitro-2-Methylphenol	U	U	µg/Kg	36	108	3550/8270C
N-Nitrosodiphenylamine	U	U	µg/Kg	51	153	3550/8270C
4-Bromophenyl Phenyl Ether	U	U	µg/Kg	38	114	3550/8270C
Hexachlorobenzene	U	U	µg/Kg	36	108	3550/8270C
Pentachlorophenol	U	U	µg/Kg	1.7	5.1	3550/8270C
Phenanthrene	11.1		µg/Kg	2	6	3550/8270C
Anthracene	2.60		µg/Kg	0.6	1.8	3550/8270C
Di-N-Butyl Phthalate	U	U	µg/Kg	34	102	3550/8270C
Fluoranthene	28.0		µg/Kg	1.6	4.8	3550/8270C
Benzidine	U	U	µg/Kg	33	99	3550/8270C
Pyrene	28.5	I	µg/Kg	2	6	3550/8270C
Butyl Benzyl Phthalate	U	U	µg/Kg	50	150	3550/8270C
Benzo(A)Anthracene	8.34		µg/Kg	1	3	3550/8270C
3,3-Dichlorobenzidine	U	U	µg/Kg	100	300	3550/8270C
Chrysene	4.92		µg/Kg	1	3	3550/8270C
Bis (2 Ethylhexyl) Phthalate	U	U	µg/Kg	39	117	3550/8270C
Di-N-Octyl Phthalate	U	U	µg/Kg	44	132	3550/8270C
Benzo(B)Fluoranthene	2.86	I	µg/Kg	1	3	3550/8270C
Benzo(K)Fluoranthene	U	U	µg/Kg	1	3	3550/8270C
Benzo(A)Pyrene	2.69		µg/Kg	1	3	3550/8270C
Indeno(1,2,3-CD)Pyrene	U	U	µg/Kg	2	6	3550/8270C
Dibenzo (A,H) Anthracene	U	U	µg/Kg	2	6	3550/8270C
Benzo(G,H,I)Perylene	U	U	µg/Kg	2	6	3550/8270C
Bis-2-ethylexyl Adipate	U	U	µg/Kg	33	99	3550/8270C
Aldrin	U	U	µg/Kg	1.0	3.0	3550/8270C
-BHC	U	U	µg/Kg	3.0	9.0	3550/8270C
-BHC	U	U	µg/Kg	3.0	9.0	3550/8270C
-BHC	U	U	µg/Kg	3.0	9.0	3550/8270C
-BHC (Lindane)	U	U	µg/Kg	1.0	3.0	3550/8270C
Clordane	U	U	µg/Kg	1.0	3.0	3550/8270C
4,4'-DDD	U	U	µg/Kg	2	6	3550/8270C
4,4'-DDE	U	U	µg/Kg	1.39	4017	3550/8270C
4,4'-DDT	U	U	µg/Kg	1.69	5.07	3550/8270C
Dieldrin	U	U	µg/Kg	0.840	2.520	3550/8270C
Endosulfan I	U	U	µg/Kg	1.100	3.300	3550/8270C
Endosulfan II	U	U	µg/Kg	1.60	4.80	3550/8270C
Endosulfan Sulfate	U	U	µg/Kg	1.70	5.10	3550/8270C
Endrin	U	U	µg/Kg	1.800	5.400	3550/8270C
Endrin Aldehyde	U	U	µg/Kg	1.900	5.700	3550/8270C
Heptachlor	U	U	µg/Kg	1.78	5.34	3550/8270C
Heptachlor Epoxide	U	U	µg/Kg	1.68	5.04	3550/8270C
Toxaphene	U	U	µg/Kg	1.90	5.70	3550/8270C
PCB-1016	U	U	µg/Kg	0.30	0.90	3550/8270C
PCB-1221	U	U	µg/Kg	0.30	0.90	3550/8270C
PCB-1232	U	U	µg/Kg	0.30	0.90	3550/8270C
PCB-1242	U	U	µg/Kg	0.30	0.90	3550/8270C

Petroleum Hydrocarbon Speciation Analysis (continued)						
PARAMETER	RESULT	QC	UNITS	MDL	PQL	METHOD
PCB-1248	U	U	µg/Kg	0.30	0.90	3550/8270C
PCB-1254	U	U	µg/Kg	0.30	0.90	3550/8270C
PCB-1260	U	U	µg/Kg	0.30	0.90	3550/8270C
Dioxin	U	U	µg/Kg	30	90	3550/8270C
Azobenzene	U	U	µg/Kg	30	90	3550/8270C
Methoxychlor	U	U	µg/Kg	19	57	3550/8270C
Benzoic Acid	U	U	µg/Kg	30	90	3550/8270C
Aniline	U	U	µg/Kg	30	90	3550/8270C
4-Chloroaniline	U	U	µg/Kg	11	33	3550/8270C
Dibenzofuran	U	U	µg/Kg	30	90	3550/8270C
2-Nitroaniline	U	U	µg/Kg	37	111	3550/8270C
30Nitroaniline	U	U	µg/Kg	30	90	3550/8270C
4-Nitroaniline	U	U	µg/Kg	30	90	3550/8270C
Carbazole	U	U	µg/Kg	30	90	3550/8270C

BLIND PASS SEDIMENT CORE BP-24 (359-360 cm)

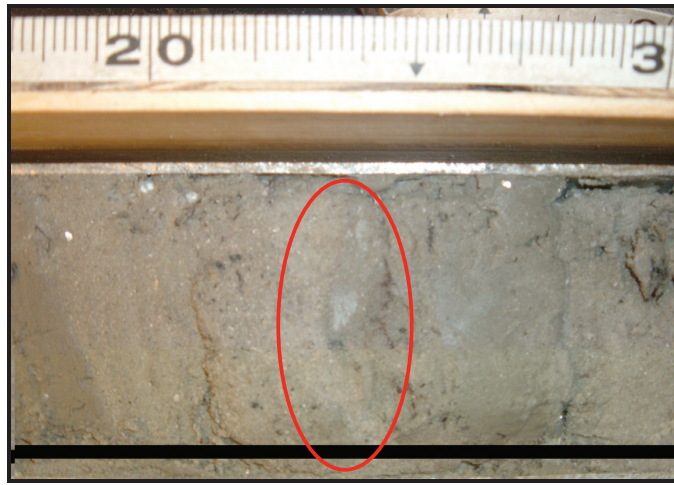

Red circle indicates area sampled for GC/MS.

C₈-C₄₀ Table						
PARAMETER	RESULT	QC	UNITS	MDL	PQL	METHOD
Percent Solids	64.9		%	0.1	0.3	EPA 160.3
FL-PRO (Petroleum Residual Organic Totals) Soil Dilution Factor = 1						
TOTAL PRO (C8-C40)	14.2	Q	mg/Kg	0.01	0.03	FL-PRO

QC=Qualifier Code as defined by DEP 62-160; U=Undetected; I=In between the MDL and PQL; Q= Out of hold; MDL=Minimum Detection Limit; PQL=Practical Quantation Limit.

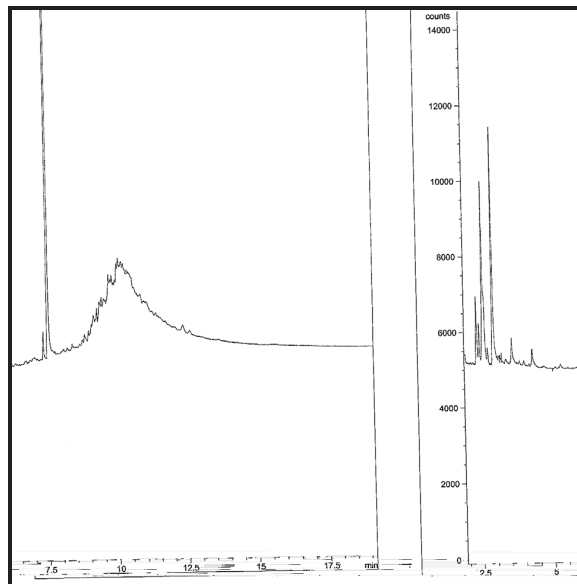

Chromatogram for sediment core BP-24 (359-360 cm).

Petroleum Hydrocarbon Speciation Analysis						
PARAMETER	RESULT	QC	UNITS	MDL	PQL	METHOD
Percent Solids	64.9		%	0.1	0.3	EPA 160.3
8260B VOA Compounds in Solids & Wastes GC/MS Dilution Factor = 1						
Methyl-tert-butyl-ether	2.32	Q	µg/Kg	0.7	2.1	5035/8260B
Methyl Ether Ketone	9.00	Q	µg/Kg	1.0	3.1	5035/8260B
Benzene	U	U	µg/Kg	0.5	1.6	5035/8260B
Toluene	U	U	µg/Kg	0.5	1.5	5035/8260B
Chlorobenzene	U	U	µg/Kg	0.7	2.1	5035/8260B
Ethylbenzene	U	U	µg/Kg	0.7	2.1	5035/8260B
M & p Xylene	U	U	µg/Kg	1.5	4.5	5035/8260B
o-Xylene	U	U	µg/Kg	0.7	2.1	5035/8260B
1,3-Dichlorobenzene	U	U	µg/Kg	1.0	3.0	5035/8260B
1,4-Dichlorobenzene	U	U	µg/Kg	0.8	2.4	5035/8260B
1,2-Dichlorobenzene	U	U	µg/Kg	0.7	2.1	5035/8260B
8270C Semivolatile Organics in Solids by GC/MS Dilution Factor = 1						
N-Nitrosodimethylamine	U	U	µg/Kg	69	207	3550/8270C
Phenol	U	U	µg/Kg	43	129	3550/8270C
2-Methyl Phenol (o-cresol)	U	U	µg/Kg	62	186	3550/8270C
3-Methyl Phenol (m-cresol)	U	U	µg/Kg	46	138	3550/8270C
4-Methyl Phenol (p-cresol)	U	U	µg/Kg	37	111	3550/8270C
Bis (2-Chloroethyl) Ether	U	U	µg/Kg	47	141	3550/8270C
2-Chlorophenol	U	U	µg/Kg	27.0	81.0	3550/8270C
1,3-Dichlorobenzene	U	U	µg/Kg	3.2	9.6	3550/8270C
1,4-Dichlorobenzene	U	U	µg/Kg	2.0	6.0	3550/8270C
Benzyl Alcohol	U	U	µg/Kg	3	9	3550/8270C
1,2-Dichlorobenzene	U	U	µg/Kg	3.5	10.5	3550/8270C
Bis (2-Chloroisopropyl) Ether	U	U	µg/Kg	47	141	3550/8270C
N-Nitrosodi-N-Propylamine	U	U	µg/Kg	24.0	72.0	3550/8270C
Hexachloroethane	U	U	µg/Kg	67	201	3550/8270C
Nitrobenzene	U	U	µg/Kg	38	114	3550/8270C
Isophorone	U	U	µg/Kg	76	228	3550/8270C
2-Nitrophenol	U	U	µg/Kg	78	234	3550/8270C
2,4-Dimethylphenol	U	U	µg/Kg	72	216	3550/8270C
Bis (2-Chloroethoxy)methane	U	U	µg/Kg	81	243	3550/8270C
2,4-Dichlorophenol	U	U	µg/Kg	59	177	3550/8270C
1,2,3-Trichlorobenzene	U	U	µg/Kg	32	96	3550/8270C
1,2,4-Trichlorobenzene	U	U	µg/Kg	42	126	3550/8270C
Naphthalene	U	U	µg/Kg	1	3	3550/8270C
Hexachlorobutadiene	U	U	µg/Kg	14	42	3550/8270C
4-Chloro-3-Methylphenol	U	U	µg/Kg	66	198	3550/8270C
1-Methylnaphthalene	U	U	µg/Kg	1	3	3550/8270C
2-Methylnaphthlene	U	U	µg/Kg	1	3	3550/8270C
Hexachlorocyclopentadiene	U	U	µg/Kg	41	123	3550/8270C
2,3,6-Trichlorophenol	U	U	µg/Kg	98	294	3550/8270C
2,4,5-Trichlorophenol	U	U	µg/Kg	60	180	3550/8270C
2,4,6-Trichlorophenol	U	U	µg/Kg	53	159	3550/8270C
2-Chloronaphthalene	U	U	µg/Kg	34	102	3550/8270C
Dimethyl Phthalate	U	U	µg/Kg	38	114	3550/8270C
Acenaphthylene	U	U	µg/Kg	2.0	6.0	3550/8270C
2,6-Dinitrotoluene	U	U	µg/Kg	26	78	3550/8270C
Acenaphthene	U	U	µg/Kg	1.3	3.9	3550/8270C

Petroleum Hydrocarbon Speciation Analysis (continued)						
PARAMETER	RESULT	QC	UNITS	MDL	PQL	METHOD
2,4-Dinitrotoluene	U	U	µg/Kg	41	123	3550/8270C
4-Nitrophenol	U	U	µg/Kg	37	111	3550/8270C
Diethyl Phthalate	U	U	µg/Kg	35	105	3550/8270C
Fluorene	U	U	µg/Kg	1.0	3.0	3550/8270C
4-Chlorophenyl Phenyl Ether	U	U	µg/Kg	45	135	3550/8270C
4,6-Dinitro-2-Methylphenol	U	U	µg/Kg	36	108	3550/8270C
N-Nitrosodiphenylamine	U	U	µg/Kg	51	153	3550/8270C
4-Bromophenyl Phenyl Ether	U	U	µg/Kg	38	114	3550/8270C
Hexachlorobenzene	U	U	µg/Kg	36	108	3550/8270C
Pentachlorophenol	U	U	µg/Kg	1.7	5.1	3550/8270C
Phenanthrene	U	U	µg/Kg	2	6	3550/8270C
Anthracene	U	U	µg/Kg	0.6	1.8	3550/8270C
Di-N-Butyl Phthalate	U	U	µg/Kg	34	102	3550/8270C
Fluoranthene	3.42	I	µg/Kg	1.6	4.8	3550/8270C
Benzidine	U	U	µg/Kg	33	99	3550/8270C
Pyrene	2.79	I	µg/Kg	2	6	3550/8270C
Butyl Benzyl Phthalate	U	U	µg/Kg	50	150	3550/8270C
Benzo(A)Anthracene	1.37	I	µg/Kg	1	3	3550/8270C
3,3-Dichlorobenzidine	U	U	µg/Kg	100	300	3550/8270C
Chrysene	U	U	µg/Kg	1	3	3550/8270C
Bis (2 Ethylhexyl) Phthalate	U	U	µg/Kg	39	117	3550/8270C
Di-N-Octyl Phthalate	U	U	µg/Kg	44	132	3550/8270C
Benzo(B)Fluoranthene	U	U	µg/Kg	1	3	3550/8270C
Benzo(K)Fluoranthene	U	U	µg/Kg	1	3	3550/8270C
Benzo(A)Pyrene	U	U	µg/Kg	1	3	3550/8270C
Indeno(1,2,3-CD)Pyrene	U	U	µg/Kg	2	6	3550/8270C
Dibenzo (A,H) Anthracene	U	U	µg/Kg	2	6	3550/8270C
Benzo(G,H,I)Perylene	U	U	µg/Kg	2	6	3550/8270C
Bis-2-ethylhexyl Adipate	U	U	µg/Kg	33	99	3550/8270C
Aldrin	U	U	µg/Kg	1.0	3.0	3550/8270C
-BHC	U	U	µg/Kg	3.0	9.0	3550/8270C
-BHC	U	U	µg/Kg	3.0	9.0	3550/8270C
-BHC	U	U	µg/Kg	3.0	9.0	3550/8270C
-BHC (Lindane)	U	U	µg/Kg	1.0	3.0	3550/8270C
Clordane	U	U	µg/Kg	1.0	3.0	3550/8270C
4,4'-DDD	U	U	µg/Kg	2	6	3550/8270C
4,4'-DDE	U	U	µg/Kg	1.39	4017	3550/8270C
4,4'-DDT	U	U	µg/Kg	1.69	5.07	3550/8270C

Petroleum Hydrocarbon Speciation Analysis (continued)						
PARAMETER	RESULT	QC	UNITS	MDL	PQL	METHOD
PCB-1248	U	U	µg/Kg	0.30	0.90	3550/8270C
PCB-1254	U	U	µg/Kg	0.30	0.90	3550/8270C
PCB-1260	U	U	µg/Kg	0.30	0.90	3550/8270C
Dioxin	U	U	µg/Kg	30	90	3550/8270C
Azobenzene	U	U	µg/Kg	30	90	3550/8270C
Methoxychlor	U	U	µg/Kg	19	57	3550/8270C
Benzoic Acid	U	U	µg/Kg	30	90	3550/8270C
Aniline	U	U	µg/Kg	30	90	3550/8270C
4-Chloroaniline	U	U	µg/Kg	11	33	3550/8270C
Dibenzofuran	U	U	µg/Kg	30	90	3550/8270C
2-Nitroaniline	U	U	µg/Kg	37	111	3550/8270C
30Nitroaniline	U	U	µg/Kg	30	90	3550/8270C
4-Nitroaniline	U	U	µg/Kg	30	90	3550/8270C
Carbazole	U	U	µg/Kg	30	90	3550/8270C

BLIND PASS SEDIMENT CORE BP-35 (116-120 cm)

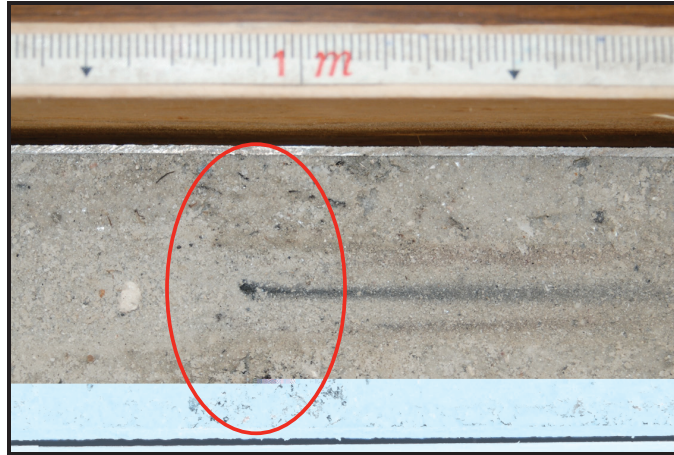

Red circle indicates area sampled for GC/MS.

C₈-C₄₀ Table						
PARAMETER	RESULT	QC	UNITS	MDL	PQL	METHOD
Percent Solids	72.0		%	0.1	0.3	EPA 160.3
FL-PRO (Petroleum Residual Organic Totals) Soil Dilution Factor = 1						
TOTAL PRO (C8-C40)	14.9		mg/Kg	0.01	0.03	FL-PRO

QC=Qualifier Code as defined by DEP 62-160; U=Undetected; I=In between the MDL and PQL; Q= Out of hold; MDL=Minimum Detection Limit; PQL=Practical Quantation Limit.

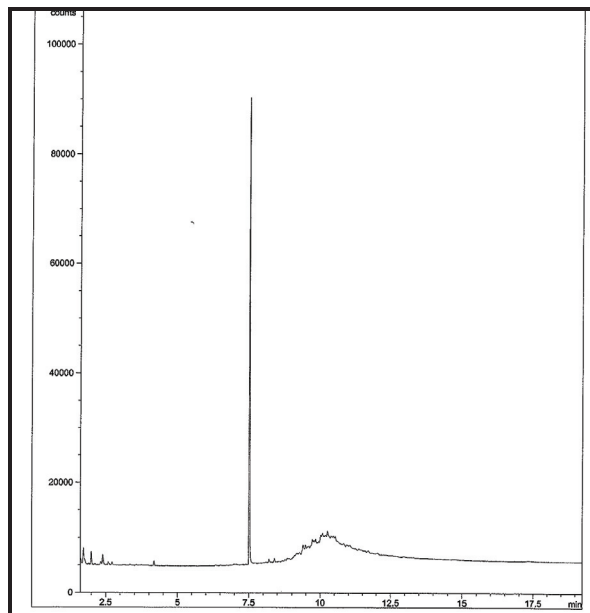

Chromatogram of sediment core BP-35 (116-120 cm).

Petroleum Hydrocarbon Speciation Analysis						
PARAMETER	RESULT	QC	UNITS	MDL	PQL	METHOD
Percent Solids	79.9		%	0.1	0.3	EPA 160.3
8260B VOA Compounds in Solids & Wastes GC/MS Dilution Factor = 1						
Methyl-tert-butyl-ether	U	U	µg/Kg	1.9	5.7	5030/8260B
Benzene	U	U	µg/Kg	0.85	2.55	5030/8260B
Toluene	U	U	µg/Kg	1.4	4.2	5030/8260B
Chlorobenzene	U	U	µg/Kg	2.3	6.9	5030/8260B
Ethylbenzene	U	U	µg/Kg	1.5	4.5	5030/8260B
M & p Xylene	U	U	µg/Kg	1.3	3.9	5030/8260B
o-Xylene	U	U	µg/Kg	1.1	3.3	5030/8260B
1,3-Dichlorobenzene	U	U	µg/Kg	3.2	9.6	5030/8260B
1,4-Dichlorobenzene	U	U	µg/Kg	2.0	6.0	5030/8260B
1,2-Dichlorobenzene	U	U	µg/Kg	3.5	10.5	5030/8260B
8270C Semivolatile Organics in Solids by GC/MS Dilution Factor = 1						
N-Nitrosodimethylamine	U	U	µg/Kg	69	207	3550/8270C
Phenol	U	U	µg/Kg	43	129	3550/8270C
2-Methyl Phenol (o-cresol)	U	U	µg/Kg	62	186	3550/8270C
3-Methyl Phenol (m-cresol)	U	U	µg/Kg	46	138	3550/8270C
4-Methyl Phenol (p-cresol)	U	U	µg/Kg	37	111	3550/8270C
Bis (2-Chloroethyl) Ether	U	U	µg/Kg	47	141	3550/8270C
2-Chlorophenol	U	U	µg/Kg	27.0	81.0	3550/8270C
1,3-Dichlorobenzene	U	U	µg/Kg	3.2	9.6	3550/8270C
1,4-Dichlorobenzene	U	U	µg/Kg	2.0	6.0	3550/8270C
Benzyl Alcohol	U	U	µg/Kg	3	9	3550/8270C
1,2-Dichlorobenzene	U	U	µg/Kg	3.5	10.5	3550/8270C
Bis (2-Chloroisopropyl) Ether	U	U	µg/Kg	47	141	3550/8270C
N-Nitrosodi-N-Proplamine	U	U	µg/Kg	24.0	72.0	3550/8270C
Hexachloroethane	U	U	µg/Kg	67	201	3550/8270C
Nitrobenzene	U	U	µg/Kg	38	114	3550/8270C
Isophorone	U	U	µg/Kg	76	228	3550/8270C
2-Nitrophenol	U	U	µg/Kg	78	234	3550/8270C
2,4-Dimethylphenol	U	U	µg/Kg	72	216	3550/8270C
Bis (2-Chloroethoxy)methane	U	U	µg/Kg	81	243	3550/8270C
2,4-Dichlorophenol	U	U	µg/Kg	59	177	3550/8270C
1,2,3-Trichlorobenzene	U	U	µg/Kg	32	96	3550/8270C
1,2,4-Trichlorobenzene	U	U	µg/Kg	42	126	3550/8270C
Naphthalene	U	U	µg/Kg	1	3	3550/8270C
Hexachlorobutadiene	U	U	µg/Kg	14	42	3550/8270C
4-Chloro-3-Methylphenol	U	U	µg/Kg	66	198	3550/8270C
1-Methylnaphthalene	U	U	µg/Kg	1	3	3550/8270C
2-Methylnaphthlene	U	U	µg/Kg	1	3	3550/8270C
Hexachlorocyclopentadiene	U	U	µg/Kg	41	123	3550/8270C
2,3,6-Trichlorophenol	U	U	µg/Kg	98	294	3550/8270C
2,4,5-Trichlorophenol	U	U	µg/Kg	60	180	3550/8270C
2,4,6-Trichlorophenol	U	U	µg/Kg	53	159	3550/8270C
2-Chloronaphthalene	U	U	µg/Kg	34	102	3550/8270C
Dimethyl Phthalate	U	U	µg/Kg	38	114	3550/8270C
Acenaphthylene	U	U	µg/Kg	2.0	6.0	3550/8270C
2,6-Dinitrotoluene	U	U	µg/Kg	26	78	3550/8270C
Acenaphthene	U	U	µg/Kg	1.3	3.9	3550/8270C
2,4-Dinitrophenol	U	U	µg/Kg	34	102	3550/8270C

Petroleum Hydrocarbon Speciation Analysis (continued)						
PARAMETER	RESULT	QC	UNITS	MDL	PQL	METHOD
2,4-Dinitrotoluene	U	U	µg/Kg	41	123	3550/8270C
4-Nitrophenol	U	U	µg/Kg	37	111	3550/8270C
Diethyl Phthalate	U	U	µg/Kg	35	105	3550/8270C
Fluorene	U	U	µg/Kg	1.0	3.0	3550/8270C
4-Chlorophenyl Phenyl Ether	U	U	µg/Kg	45	135	3550/8270C
4,6-Dinitro-2-Methylphenol	U	U	µg/Kg	36	108	3550/8270C
N-Nitrosodiphenylamine	U	U	µg/Kg	51	153	3550/8270C
4-Bromophenyl Phenyl Ether	U	U	µg/Kg	38	114	3550/8270C
Hexachlorobenzene	U	U	µg/Kg	36	108	3550/8270C
Pentachlorophenol	U	U	µg/Kg	1.7	5.1	3550/8270C
Phenanthrene	U	U	µg/Kg	2	6	3550/8270C
Anthracene	U	U	µg/Kg	0.6	1.8	3550/8270C
Di-N-Butyl Phthalate	U	U	µg/Kg	34	102	3550/8270C
Fluoranthene	U	U	µg/Kg	1.6	4.8	3550/8270C
Benzidine	U	U	µg/Kg	33	99	3550/8270C
Pyrene	U	U	µg/Kg	2	6	3550/8270C
Butyl Benzyl Phthalate	U	U	µg/Kg	50	150	3550/8270C
Benzo(A)Anthracene	U	U	µg/Kg	1	3	3550/8270C
3,3-Dichlorobenzidine	U	U	µg/Kg	100	300	3550/8270C
Chrysene	U	U	µg/Kg	1	3	3550/8270C
Bis (2 Ethylhexyl) Phthalate	U	U	µg/Kg	39	117	3550/8270C
Di-N-Octyl Phthalate	U	U	µg/Kg	44	132	3550/8270C
Benzo(B)Fluoranthene	U	U	µg/Kg	1	3	3550/8270C
Benzo(K)Fluoranthene	U	U	µg/Kg	1	3	3550/8270C
Benzo(A)Pyrene	U	U	µg/Kg	1	3	3550/8270C
Indeno(1,2,3-CD)Pyrene	U	U	µg/Kg	2	6	3550/8270C
Dibenzo (A,H) Anthracene	U	U	µg/Kg	2	6	3550/8270C
Benzo(G,H,I)Perylene	U	U	µg/Kg	2	6	3550/8270C
Bis-2-ethylexyl Adipate	U	U	µg/Kg	33	99	3550/8270C
Aldrin	U	U	µg/Kg	1.0	3.0	3550/8270C
-BHC	U	U	µg/Kg	3.0	9.0	3550/8270C
-BHC	U	U	µg/Kg	3.0	9.0	3550/8270C
-BHC	U	U	µg/Kg	3.0	9.0	3550/8270C
-BHC (Lindane)	U	U	µg/Kg	1.0	3.0	3550/8270C
Clordane	U	U	µg/Kg	1.0	3.0	3550/8270C
4,4'-DDD	U	U	µg/Kg	2	6	3550/8270C
4,4'-DDE	U	U	µg/Kg	1.39	4017	3550/8270C
4,4'-DDT	U	U	µg/Kg	1.69	5.07	3550/8270C
Dieldrin	U	U	µg/Kg	0.840	2.520	3550/8270C
Endosulfan I	U	U	µg/Kg	1.100	3.300	3550/8270C
Endosulfan II	U	U	µg/Kg	1.60	4.80	3550/8270C
Endosulfan Sulfate	U	U	µg/Kg	1.70	5.10	3550/8270C
Endrin	U	U	µg/Kg	1.800	5.400	3550/8270C
Endrin Aldehyde	U	U	µg/Kg	1.900	5.700	3550/8270C
Heptachlor	U	U	µg/Kg	1.78	5.34	3550/8270C
Heptachlor Epoxide	U	U	µg/Kg	1.68	5.04	3550/8270C
Toxaphene	U	U	µg/Kg	1.90	5.70	3550/8270C
PCB-1016	U	U	µg/Kg	0.30	0.90	3550/8270C
PCB-1221	U	U	µg/Kg	0.30	0.90	3550/8270C
PCB-1232	U	U	µg/Kg	0.30	0.90	3550/8270C
PCB-1242	U	U	µg/Kg	0.30	0.90	3550/8270C

Petroleum Hydrocarbon Speciation Analysis (continued)						
PARAMETER	RESULT	QC	UNITS	MDL	PQL	METHOD
PCB-1248	U	U	µg/Kg	0.30	0.90	3550/8270C
PCB-1254	U	U	µg/Kg	0.30	0.90	3550/8270C
PCB-1260	U	U	µg/Kg	0.30	0.90	3550/8270C
Dioxin	U	U	µg/Kg	30	90	3550/8270C
Azobenzene	U	U	µg/Kg	30	90	3550/8270C
Methoxychlor	U	U	µg/Kg	19	57	3550/8270C
Benzoic Acid	U	U	µg/Kg	30	90	3550/8270C
Aniline	U	U	µg/Kg	30	90	3550/8270C
4-Chloroaniline	U	U	µg/Kg	11	33	3550/8270C
Dibenzofuran	U	U	µg/Kg	30	90	3550/8270C
2-Nitroaniline	U	U	µg/Kg	37	111	3550/8270C
30Nitroaniline	U	U	µg/Kg	30	90	3550/8270C
4-Nitroaniline	U	U	µg/Kg	30	90	3550/8270C
Carbazole	U	U	µg/Kg	30	90	3550/8270C
2,6-Dichlorophenol	U	U	µg/Kg	17	51	3550/8270C
2,3,4,6-Tetrachlorophenol	U	U	µg/Kg	30	90	3550/8270C
2,3,5,6-Tetrachlorophenol	U	U	µg/Kg	30	90	3550/8270C
Pyridine	U	U	µg/Kg	67	201	3550/8270C
FL-PRO (Petroleum Residual Organic Totals) Soil Dilution Factor = 1						
TOTAL PRO (C8-C40)	14.9		mg/Kg	0.01	0.03	FL-PRO
TPHCWG TPH-CWG Speciation Method (Soils) Dilution Factor = 1						
C5-C7 Aromatics	U	U	µg/Kg	5.0	15.0	TPHCWG
C7-C8 Aromatics	U	U	µg/Kg	5.0	15.0	TPHCWG
C8-C10 Aromatics	U	U	µg/Kg	5.0	15.0	TPHCWG
C10-C12 Aromatics	U	U	µg/Kg	5.0	15.0	TPHCWG
C12-C16 Aromatics	U	U	µg/Kg	5.0	15.0	TPHCWG
C16-C21 Aromatics	U	U	µg/Kg	5.0	15.0	TPHCWG
C21-C35 Aromatics	U	U	µg/Kg	5.0	15.0	TPHCWG
C5-C6 Aliphatics	U	U	µg/Kg	5.0	15.0	TPHCWG
C6-C8 Aliphatics	U	U	µg/Kg	5.0	15.0	TPHCWG
C8-C10 Aliphatics	U	U	µg/Kg	5.0	15.0	TPHCWG
C10-C12 Aliphatics	U	U	µg/Kg	5.0	15.0	TPHCWG
C12-C16 Aliphatics	U	U	µg/Kg	5.0	15.0	TPHCWG
C16-C35 Aliphatics	26.7		µg/Kg	5.0	15.0	TPHCWG

QC=Qualifier Code as defined by DEP 62-160; U=Undetected; MDL=Minimum Detection Limit; PQL=Practical Quantization Limit.

BLIND PASS SEDIMENT CORE BP-73 (48-53 cm)



Red circle indicates area sampled for GC/MS analysis.

C₈-C₄₀ Table						
PARAMETER	RESULT	QC	UNITS	MDL	PQL	METHOD
Percent Solids	66.7		%	0.1	0.3	EPA 160.3
FL-PRO (Petroleum Residual Organic Totals) Soil Dilution Factor = 1						
TOTAL PRO (C8-C40)	6.77		mg/Kg	0.01	0.03	FL-PRO

QC=Qualifier Code as defined by DEP 62-160; U=Undetected; I=In between the MDL and PQL; Q= Out of hold; MDL=Minimum Detection Limit; PQL=Practical Quantation Limit.

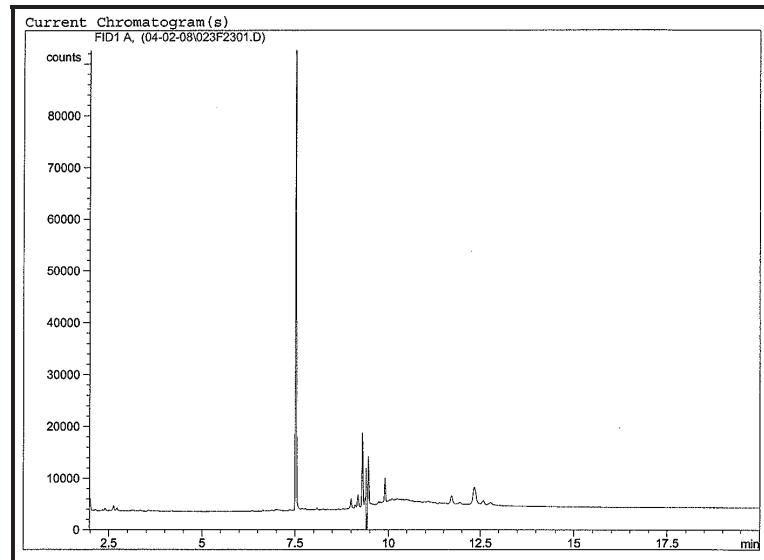

Chromatogram for sediment core BP-73 (48-53 cm).

Petroleum Hydrocarbon Speciation Analysis						
PARAMETER	RESULT	QC	UNITS	MDL	PQL	METHOD
Percent Solids	79.9		%	0.1	0.3	EPA 160.3
8260B VOA Compounds in Solids & Wastes GC/MS Dilution Factor = 1						
Methyl-tert-butyl-ether	U	U	µg/Kg	1.9	5.7	5030/8260B
Benzene	U	U	µg/Kg	0.85	2.55	5030/8260B
Toluene	U	U	µg/Kg	1.4	4.2	5030/8260B
Chlorobenzene	U	U	µg/Kg	2.3	6.9	5030/8260B
Ethylbenzene	U	U	µg/Kg	1.5	4.5	5030/8260B
M & p Xylene	U	U	µg/Kg	1.3	3.9	5030/8260B
o-Xylene	U	U	µg/Kg	1.1	3.3	5030/8260B
1,3-Dichlorobenzene	U	U	µg/Kg	3.2	9.6	5030/8260B
1,4-Dichlorobenzene	U	U	µg/Kg	2.0	6.0	5030/8260B
1,2-Dichlorobenzene	U	U	µg/Kg	3.5	10.5	5030/8260B
8270C Semivolatile Organics in Solids by GC/MS Dilution Factor = 1						
N-Nitrosodimethylamine	U	U	µg/Kg	69	207	3550/8270C
Phenol	U	U	µg/Kg	43	129	3550/8270C
2-Methyl Phenol (o-cresol)	U	U	µg/Kg	62	186	3550/8270C
3-Methyl Phenol (m-cresol)	U	U	µg/Kg	46	138	3550/8270C
4-Methyl Phenol (p-cresol)	U	U	µg/Kg	37	111	3550/8270C
Bis (2-Chloroethyl) Ether	U	U	µg/Kg	47	141	3550/8270C
2-Chlorophenol	U	U	µg/Kg	27.0	81.0	3550/8270C
1,3-Dichlorobenzene	U	U	µg/Kg	3.2	9.6	3550/8270C
1,4-Dichlorobenzene	U	U	µg/Kg	2.0	6.0	3550/8270C
Benzyl Alcohol	U	U	µg/Kg	3	9	3550/8270C
1,2-Dichlorobenzene	U	U	µg/Kg	3.5	10.5	3550/8270C
Bis (2-Chloroisopropyl) Ether	U	U	µg/Kg	47	141	3550/8270C
N-Nitrosodi-N-Proplamine	U	U	µg/Kg	24.0	72.0	3550/8270C
Hexachloroethane	U	U	µg/Kg	67	201	3550/8270C
Nitrobenzene	U	U	µg/Kg	38	114	3550/8270C
Isophorone	U	U	µg/Kg	76	228	3550/8270C
2-Nitrophenol	U	U	µg/Kg	78	234	3550/8270C
2,4-Dimethylphenol	U	U	µg/Kg	72	216	3550/8270C
Bis (2-Chloroethoxy)methane	U	U	µg/Kg	81	243	3550/8270C
2,4-Dichlorophenol	U	U	µg/Kg	59	177	3550/8270C
1,2,3-Trichlorobenzene	U	U	µg/Kg	32	96	3550/8270C
1,2,4-Trichlorobenzene	U	U	µg/Kg	42	126	3550/8270C
Naphthalene	U	U	µg/Kg	1	3	3550/8270C
Hexachlorobutadiene	U	U	µg/Kg	14	42	3550/8270C
4-Chloro-3-Methylphenol	U	U	µg/Kg	66	198	3550/8270C
1-Methylnaphthalene	U	U	µg/Kg	1	3	3550/8270C
2-Methylnaphthlene	U	U	µg/Kg	1	3	3550/8270C
Hexachlorocyclopentadiene	U	U	µg/Kg	41	123	3550/8270C
2,3,6-Trichlorophenol	U	U	µg/Kg	98	294	3550/8270C
2,4,5-Trichlorophenol	U	U	µg/Kg	60	180	3550/8270C
2,4,6-Trichlorophenol	U	U	µg/Kg	53	159	3550/8270C
2-Chloronaphthalene	U	U	µg/Kg	34	102	3550/8270C
Dimethyl Phthalate	U	U	µg/Kg	38	114	3550/8270C
Acenaphthylene	U	U	µg/Kg	2.0	6.0	3550/8270C
2,6-Dinitrotoluene	U	U	µg/Kg	26	78	3550/8270C
Acenaphthene	U	U	µg/Kg	1.3	3.9	3550/8270C
2,4-Dinitrophenol	U	U	µg/Kg	34	102	3550/8270C

Petroleum Hydrocarbon Speciation Analysis (continued)						
PARAMETER	RESULT	QC	UNITS	MDL	PQL	METHOD
2,4-Dinitrotoluene	U	U	µg/Kg	41	123	3550/8270C
4-Nitrophenol	U	U	µg/Kg	37	111	3550/8270C
Diethyl Phthalate	U	U	µg/Kg	35	105	3550/8270C
Fluorene	U	U	µg/Kg	1.0	3.0	3550/8270C
4-Chlorophenyl Phenyl Ether	U	U	µg/Kg	45	135	3550/8270C
4,6-Dinitro-2-Methylphenol	U	U	µg/Kg	36	108	3550/8270C
N-Nitrosodiphenylamine	U	U	µg/Kg	51	153	3550/8270C
4-Bromophenyl Phenyl Ether	U	U	µg/Kg	38	114	3550/8270C
Hexachlorobenzene	U	U	µg/Kg	36	108	3550/8270C
Pentachlorophenol	U	U	µg/Kg	1.7	5.1	3550/8270C
Phenanthrene	U	U	µg/Kg	2	6	3550/8270C
Anthracene	U	U	µg/Kg	0.6	1.8	3550/8270C
Di-N-Butyl Phthalate	U	U	µg/Kg	34	102	3550/8270C
Fluoranthene	U	U	µg/Kg	1.6	4.8	3550/8270C
Benzidine	U	U	µg/Kg	33	99	3550/8270C
Pyrene	U	U	µg/Kg	2	6	3550/8270C
Butyl Benzyl Phthalate	U	U	µg/Kg	50	150	3550/8270C
Benzo(A)Anthracene	U	U	µg/Kg	1	3	3550/8270C
3,3-Dichlorobenzidine	U	U	µg/Kg	100	300	3550/8270C
Chrysene	U	U	µg/Kg	1	3	3550/8270C
Bis (2 Ethylhexyl) Phthalate	U	U	µg/Kg	39	117	3550/8270C
Di-N-Octyl Phthalate	U	U	µg/Kg	44	132	3550/8270C
Benzo(B)Fluoranthene	U	U	µg/Kg	1	3	3550/8270C
Benzo(K)Fluoranthene	U	U	µg/Kg	1	3	3550/8270C
Benzo(A)Pyrene	U	U	µg/Kg	1	3	3550/8270C
Indeno(1,2,3-CD)Pyrene	U	U	µg/Kg	2	6	3550/8270C
Dibenzo (A,H) Anthracene	U	U	µg/Kg	2	6	3550/8270C
Benzo(G,H,I)Perylene	U	U	µg/Kg	2	6	3550/8270C
Bis-2-ethylexyl Adipate	U	U	µg/Kg	33	99	3550/8270C
Aldrin	U	U	µg/Kg	1.0	3.0	3550/8270C
-BHC	U	U	µg/Kg	3.0	9.0	3550/8270C
-BHC	U	U	µg/Kg	3.0	9.0	3550/8270C
-BHC	U	U	µg/Kg	3.0	9.0	3550/8270C
-BHC (Lindane)	U	U	µg/Kg	1.0	3.0	3550/8270C
Clordane	U	U	µg/Kg	1.0	3.0	3550/8270C
4,4'-DDD	U	U	µg/Kg	2	6	3550/8270C
4,4'-DDE	U	U	µg/Kg	1.39	4017	3550/8270C
4,4'-DDT	U	U	µg/Kg	1.69	5.07	3550/8270C
Dieldrin	U	U	µg/Kg	0.840	2.520	3550/8270C
Endosulfan I	U	U	µg/Kg	1.100	3.300	3550/8270C
Endosulfan II	U	U	µg/Kg	1.60	4.80	3550/8270C
Endosulfan Sulfate	U	U	µg/Kg	1.70	5.10	3550/8270C
Endrin	U	U	µg/Kg	1.800	5.400	3550/8270C
Endrin Aldehyde	U	U	µg/Kg	1.900	5.700	3550/8270C
Heptachlor	U	U	µg/Kg	1.78	5.34	3550/8270C
Heptachlor Epoxide	U	U	µg/Kg	1.68	5.04	3550/8270C
Toxaphene	U	U	µg/Kg	1.90	5.70	3550/8270C
PCB-1016	U	U	µg/Kg	0.30	0.90	3550/8270C
PCB-1221	U	U	µg/Kg	0.30	0.90	3550/8270C
PCB-1232	U	U	µg/Kg	0.30	0.90	3550/8270C
PCB-1242	U	U	µg/Kg	0.30	0.90	3550/8270C

Petroleum Hydrocarbon Speciation Analysis (continued)						
PARAMETER	RESULT	QC	UNITS	MDL	PQL	METHOD
PCB-1248	U	U	µg/Kg	0.30	0.90	3550/8270C
PCB-1254	U	U	µg/Kg	0.30	0.90	3550/8270C
PCB-1260	U	U	µg/Kg	0.30	0.90	3550/8270C
Dioxin	U	U	µg/Kg	30	90	3550/8270C
Azobenzene	U	U	µg/Kg	30	90	3550/8270C
Methoxychlor	U	U	µg/Kg	19	57	3550/8270C
Benzoic Acid	U	U	µg/Kg	30	90	3550/8270C
Aniline	U	U	µg/Kg	30	90	3550/8270C
4-Chloroaniline	U	U	µg/Kg	11	33	3550/8270C
Dibenzofuran	U	U	µg/Kg	30	90	3550/8270C
2-Nitroaniline	U	U	µg/Kg	37	111	3550/8270C
30Nitroaniline	U	U	µg/Kg	30	90	3550/8270C
4-Nitroaniline	U	U	µg/Kg	30	90	3550/8270C
Carbazole	U	U	µg/Kg	30	90	3550/8270C

BLIND PASS SEDIMENT CORE BP-C (256-261 cm)



Red circle indicates area sampled for GC/MS analysis.

C₈-C₄₀ Table						
PARAMETER	RESULT	QC	UNITS	MDL	PQL	METHOD
Percent Solids	74.4		%	0.1	0.3	EPA 160.3
FL-PRO (Petroleum Residual Organic Totals) Soil Dilution Factor = 1						
TOTAL PRO (C8-C40)	9.33		mg/Kg	0.01	0.03	FL-PRO

QC=Qualifier Code as defined by DEP 62-160; U=Undetected; I=In between the MDL and PQL; Q= Out of hold; MDL=Minimum Detection Limit; PQL=Practical Quantitation Limit.

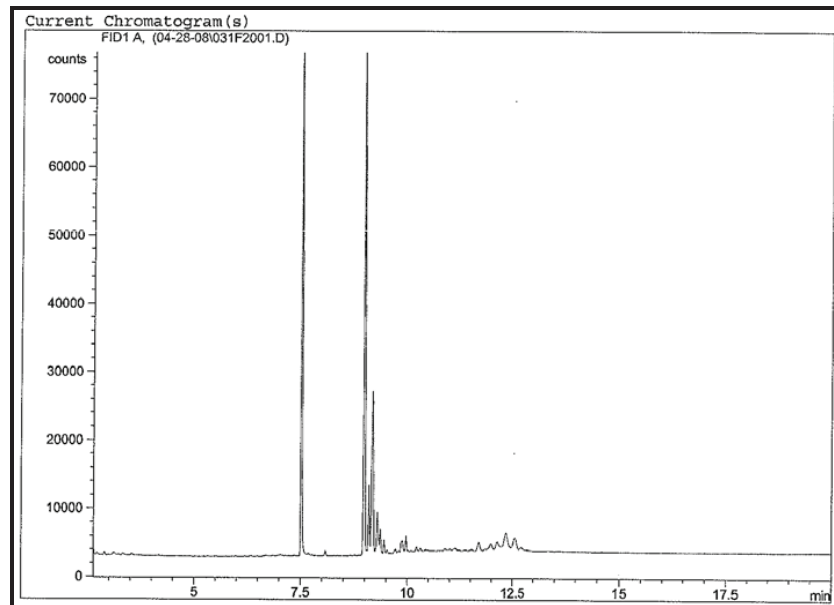

Chromatogram for sediment core BP-3 (256-261 cm).

Petroleum Hydrocarbon Speciation Analysis						
PARAMETER	RESULT	QC	UNITS	MDL	PQL	METHOD
Percent Solids	74.4		%	0.1	0.3	EPA 160.3
8260B VOA Compounds in Solids & Wastes GC/MS Dilution Factor = 1						
Methyl-tert-butyl-ether	1.72	Q	µg/Kg	0.7	2.1	5035/8260B
Methyl Ether Ketone	1.92	Q	µg/Kg	1.0	3.1	5035/8260B
Benzene	U	U	µg/Kg	0.5	1.6	5035/8260B
Toluene	U	U	µg/Kg	0.5	1.5	5035/8260B
Chlorobenzene	U	U	µg/Kg	0.7	2.1	5035/8260B
Ethylbenzene	U	U	µg/Kg	0.7	2.1	5035/8260B
M & p Xylene	U	U	µg/Kg	1.5	4.5	5035/8260B
o-Xylene	U	U	µg/Kg	0.7	2.1	5035/8260B
1,3-Dichlorobenzene	U	U	µg/Kg	1.0	3.0	5035/8260B
1,4-Dichlorobenzene	U	U	µg/Kg	0.8	2.4	5035/8260B
1,2-Dichlorobenzene	U	U	µg/Kg	0.7	2.1	5035/8260B
8270C Semivolatile Organics in Solids by GC/MS Dilution Factor = 1						
N-Nitrosodimethylamine	U	U	µg/Kg	69	207	3550/8270C
Phenol	U	U	µg/Kg	43	129	3550/8270C
2-Methyl Phenol (o-cresol)	U	U	µg/Kg	62	186	3550/8270C
3-Methyl Phenol (m-cresol)	U	U	µg/Kg	46	138	3550/8270C
4-Methyl Phenol (p-cresol)	U	U	µg/Kg	37	111	3550/8270C
Bis (2-Chloroethyl) Ether	U	U	µg/Kg	47	141	3550/8270C
2-Chlorophenol	U	U	µg/Kg	27.0	81.0	3550/8270C
1,3-Dichlorobenzene	U	U	µg/Kg	3.2	9.6	3550/8270C
1,4-Dichlorobenzene	U	U	µg/Kg	2.0	6.0	3550/8270C
Benzyl Alcohol	U	U	µg/Kg	3	9	3550/8270C
1,2-Dichlorobenzene	U	U	µg/Kg	3.5	10.5	3550/8270C
Bis (2-Chloroisopropyl) Ether	U	U	µg/Kg	47	141	3550/8270C
N-Nitrosodi-N-Propylamine	U	U	µg/Kg	24.0	72.0	3550/8270C
Hexachloroethane	U	U	µg/Kg	67	201	3550/8270C
Nitrobenzene	U	U	µg/Kg	38	114	3550/8270C
Isophorone	U	U	µg/Kg	76	228	3550/8270C
2-Nitrophenol	U	U	µg/Kg	78	234	3550/8270C
2,4-Dimethylphenol	U	U	µg/Kg	72	216	3550/8270C
Bis (2-Chloroethoxy)methane	U	U	µg/Kg	81	243	3550/8270C
2,4-Dichlorophenol	U	U	µg/Kg	59	177	3550/8270C
1,2,3-Trichlorobenzene	U	U	µg/Kg	32	96	3550/8270C
1,2,4-Trichlorobenzene	U	U	µg/Kg	42	126	3550/8270C
Naphthalene	U	U	µg/Kg	1	3	3550/8270C
Hexachlorobutadiene	U	U	µg/Kg	14	42	3550/8270C
4-Chloro-3-Methylphenol	U	U	µg/Kg	66	198	3550/8270C
1-Methylnaphthalene	U	U	µg/Kg	1	3	3550/8270C
2-Methylnaphthlene	U	U	µg/Kg	1	3	3550/8270C
Hexachlorocyclopentadiene	U	U	µg/Kg	41	123	3550/8270C
2,3,6-Trichlorophenol	U	U	µg/Kg	98	294	3550/8270C
2,4,5-Trichlorophenol	U	U	µg/Kg	60	180	3550/8270C
2,4,6-Trichlorophenol	U	U	µg/Kg	53	159	3550/8270C
2-Chloronaphthalene	U	U	µg/Kg	34	102	3550/8270C
Dimethyl Phthalate	U	U	µg/Kg	38	114	3550/8270C
Acenaphthylene	U	U	µg/Kg	2.0	6.0	3550/8270C
2,6-Dinitrotoluene	U	U	µg/Kg	26	78	3550/8270C
Acenaphthene	U	U	µg/Kg	1.3	3.9	3550/8270C

Petroleum Hydrocarbon Speciation Analysis (continued)						
PARAMETER	RESULT	QC	UNITS	MDL	PQL	METHOD
2,4-Dinitrotoluene	U	U	µg/Kg	41	123	3550/8270C
4-Nitrophenol	U	U	µg/Kg	37	111	3550/8270C
Diethyl Phthalate	U	U	µg/Kg	35	105	3550/8270C
Fluorene	U	U	µg/Kg	1.0	3.0	3550/8270C
4-Chlorophenyl Phenyl Ether	U	U	µg/Kg	45	135	3550/8270C
4,6-Dinitro-2-Methylphenol	U	U	µg/Kg	36	108	3550/8270C
N-Nitrosodiphenylamine	U	U	µg/Kg	51	153	3550/8270C
4-Bromophenyl Phenyl Ether	U	U	µg/Kg	38	114	3550/8270C
Hexachlorobenzene	U	U	µg/Kg	36	108	3550/8270C
Pentachlorophenol	U	U	µg/Kg	1.7	5.1	3550/8270C
Phenanthrene	2.48	U	µg/Kg	2	6	3550/8270C
Anthracene	U	U	µg/Kg	0.6	1.8	3550/8270C
Di-N-Butyl Phthalate	U	U	µg/Kg	34	102	3550/8270C
Fluoranthene	12.5	U	µg/Kg	1.6	4.8	3550/8270C
Benzidine	U	U	µg/Kg	33	99	3550/8270C
Pyrene	10.9	U	µg/Kg	2	6	3550/8270C
Butyl Benzyl Phthalate	U	U	µg/Kg	50	150	3550/8270C
Benzo(A)Anthracene	1.83	U	µg/Kg	1	3	3550/8270C
3,3-Dichlorobenzidine	U	U	µg/Kg	100	300	3550/8270C
Chrysene	7.92	U	µg/Kg	1	3	3550/8270C
Bis (2 Ethylhexyl) Phthalate	U	U	µg/Kg	39	117	3550/8270C
Di-N-Octyl Phthalate	U	U	µg/Kg	44	132	3550/8270C
Benzo(B)Fluoranthene	11.3	U	µg/Kg	1	3	3550/8270C
Benzo(K)Fluoranthene	5.81	U	µg/Kg	1	3	3550/8270C
Benzo(A)Pyrene	8.72	U	µg/Kg	1	3	3550/8270C
Indeno(1,2,3-CD)Pyrene	11.5	U	µg/Kg	2	6	3550/8270C
Dibenzo (A,H) Anthracene	U	U	µg/Kg	2	6	3550/8270C
Benzo(G,H,I)Perylene	5.98	U	µg/Kg	2	6	3550/8270C
Bis-2-ethylhexyl Adipate	U	U	µg/Kg	33	99	3550/8270C
Aldrin	U	U	µg/Kg	1.0	3.0	3550/8270C
-BHC	U	U	µg/Kg	3.0	9.0	3550/8270C
-BHC	U	U	µg/Kg	3.0	9.0	3550/8270C
-BHC	U	U	µg/Kg	3.0	9.0	3550/8270C
-BHC (Lindane)	U	U	µg/Kg	1.0	3.0	3550/8270C
Clordane	U	U	µg/Kg	1.0	3.0	3550/8270C
4,4'-DDD	U	U	µg/Kg	2	6	3550/8270C
4,4'-DDE	U	U	µg/Kg	1.39	4017	3550/8270C
4,4'-DDT	U	U	µg/Kg	1.69	5.07	3550/8270C
Dieldrin	U	U	µg/Kg	0.840	2.520	3550/8270C
Endosulfan I	U	U	µg/Kg	1.100	3.300	3550/8270C
Endosulfan II	U	U	µg/Kg	1.60	4.80	3550/8270C
Endosulfan Sulfate	U	U	µg/Kg	1.70	5.10	3550/8270C
Endrin	U	U	µg/Kg	1.800	5.400	3550/8270C
Endrin Aldehyde	U	U	µg/Kg	1.900	5.700	3550/8270C
Heptachlor	U	U	µg/Kg	1.78	5.34	3550/8270C
Heptachlor Epoxide	U	U	µg/Kg	1.68	5.04	3550/8270C
Toxaphene	U	U	µg/Kg	1.90	5.70	3550/8270C
PCB-1016	U	U	µg/Kg	0.30	0.90	3550/8270C
PCB-1221	U	U	µg/Kg	0.30	0.90	3550/8270C
PCB-1232	U	U	µg/Kg	0.30	0.90	3550/8270C
PCB-1242	U	U	µg/Kg	0.30	0.90	3550/8270C

Petroleum Hydrocarbon Speciation Analysis (continued)						
PARAMETER	RESULT	QC	UNITS	MDL	PQL	METHOD
PCB-1248	U	U	µg/Kg	0.30	0.90	3550/8270C
PCB-1254	U	U	µg/Kg	0.30	0.90	3550/8270C
PCB-1260	U	U	µg/Kg	0.30	0.90	3550/8270C
Dioxin	U	U	µg/Kg	30	90	3550/8270C
Azobenzene	U	U	µg/Kg	30	90	3550/8270C
Methoxychlor	U	U	µg/Kg	19	57	3550/8270C
Benzoic Acid	U	U	µg/Kg	30	90	3550/8270C
Aniline	U	U	µg/Kg	30	90	3550/8270C
4-Chloroaniline	U	U	µg/Kg	11	33	3550/8270C
Dibenzofuran	U	U	µg/Kg	30	90	3550/8270C
2-Nitroaniline	U	U	µg/Kg	37	111	3550/8270C
30Nitroaniline	U	U	µg/Kg	30	90	3550/8270C
4-Nitroaniline	U	U	µg/Kg	30	90	3550/8270C
Carbazole	U	U	µg/Kg	30	90	3550/8270C
2,6-Dichlorophenol	U	U	µg/Kg	17	51	3550/8270C
2,3,4,6-Tetrachlorophenol	U	U	µg/Kg	30	90	3550/8270C
2,3,5,6-Tetrachlorophenol	U	U	µg/Kg	30	90	3550/8270C
Pyridine	U	U	µg/Kg	67	201	3550/8270C
FL-PRO (Petroleum Residual Organic Totals) Soil Dilution Factor = 1						
TOTAL PRO (C8-C40)	9.33		mg/Kg	0.01	0.03	FL-PRO
TPHCWG TPH-CWG Speciation Method (Soils) Dilution Factor = 1						
C5-C7 Aromatics	U	U	µg/Kg	5.0	15.0	TPHCWG
C7-C8 Aromatics	U	U	µg/Kg	5.0	15.0	TPHCWG
C8-C10 Aromatics	U	U	µg/Kg	5.0	15.0	TPHCWG
C10-C12 Aromatics	U	U	µg/Kg	5.0	15.0	TPHCWG
C12-C16 Aromatics	12.0	U	µg/Kg	5.0	15.0	TPHCWG
C16-C21 Aromatics	59.2	U	µg/Kg	5.0	15.0	TPHCWG
C21-C35 Aromatics	17.5	U	µg/Kg	5.0	15.0	TPHCWG
C5-C6 Aliphatics	U	U	µg/Kg	5.0	15.0	TPHCWG
C6-C8 Aliphatics	U	U	µg/Kg	5.0	15.0	TPHCWG
C8-C10 Aliphatics	U	U	µg/Kg	5.0	15.0	TPHCWG
C10-C12 Aliphatics	U	U	µg/Kg	5.0	15.0	TPHCWG
C12-C16 Aliphatics	U	U	µg/Kg	5.0	15.0	TPHCWG
C16-C35 Aliphatics	9980	U	µg/Kg	5.0	15.0	TPHCWG

QC=Qualifier Code as defined by DEP 62-160; U=Undetected; MDL=Minimum Detection Limit; PQL=Practical Quantation Limit.

BLIND PASS SEDIMENT CORE BP-81 (250-260 cm)



Red circle indicates area sampled for GC/MS analysis.

C₈-C₄₀ Table						
PARAMETER	RESULT	QC	UNITS	MDL	PQL	METHOD
Percent Solids	90.8		%	0.1	0.3	EPA 160.3
FL-PRO (Petroleum Residual Organic Totals) Soil Dilution Factor = 1						
TOTAL PRO (C8-C40)	32.6	U	mg/Kg	0.01	0.03	FL-PRO

QC=Qualifier Code as defined by DEP 62-160; U=Undetected; I=In between the MDL and PQL; Q= Out of hold; MDL=Minimum Detection Limit; PQL=Practical Quantation Limit.

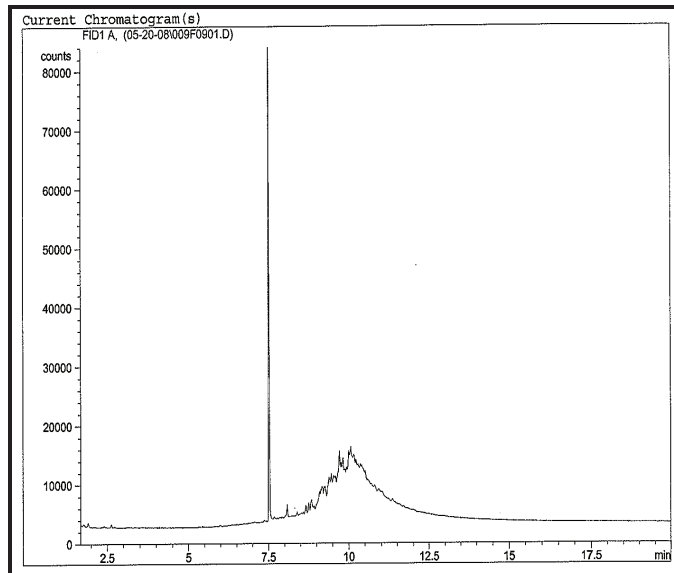

Chromatogram for sediment core BP-81 (250-260 cm).

Petroleum Hydrocarbon Speciation Analysis						
PARAMETER	RESULT	QC	UNITS	MDL	PQL	METHOD
Percent Solids	90.8		%	0.1	0.3	EPA 160.3
8260B VOA Compounds in Solids & Wastes GC/MS Dilution Factor = 1						
Methyl-tert-butyl-ether	U	U	µg/Kg	1.9	5.7	5030/8260B
Benzene	U	U	µg/Kg	0.85	2.55	5030/8260B
Toluene	U	U	µg/Kg	1.4	4.2	5030/8260B
Chlorobenzene	U	U	µg/Kg	2.3	6.9	5030/8260B
Ethylbenzene	U	U	µg/Kg	1.5	4.5	5030/8260B
M & p Xylene	U	U	µg/Kg	1.3	3.9	5030/8260B
o-Xylene	U	U	µg/Kg	1.1	3.3	5030/8260B
1,3-Dichlorobenzene	U	U	µg/Kg	3.2	9.6	5030/8260B
1,4-Dichlorobenzene	U	U	µg/Kg	2.0	6.0	5030/8260B
1,2-Dichlorobenzene	U	U	µg/Kg	3.5	10.5	5030/8260B
8270C Semivolatile Organics in Solids by GC/MS Dilution Factor = 1						
N-Nitrosodimethylamine	U	U	µg/Kg	69	207	3550/8270C
Phenol	U	U	µg/Kg	43	129	3550/8270C
2-Methyl Phenol (o-cresol)	U	U	µg/Kg	62	186	3550/8270C
3-Methyl Phenol (m-cresol)	U	U	µg/Kg	46	138	3550/8270C
4-Methyl Phenol (p-cresol)	U	U	µg/Kg	37	111	3550/8270C
Bis (2-Chloroethyl) Ether	U	U	µg/Kg	47	141	3550/8270C
2-Chlorophenol	U	U	µg/Kg	27.0	81.0	3550/8270C
1,3-Dichlorobenzene	U	U	µg/Kg	3.2	9.6	3550/8270C
1,4-Dichlorobenzene	U	U	µg/Kg	2.0	6.0	3550/8270C
Benzyl Alcohol	U	U	µg/Kg	3	9	3550/8270C
1,2-Dichlorobenzene	U	U	µg/Kg	3.5	10.5	3550/8270C
Bis (2-Chloroisopropyl) Ether	U	U	µg/Kg	47	141	3550/8270C
N-Nitrosodi-N-Proplamine	U	U	µg/Kg	24.0	72.0	3550/8270C
Hexachloroethane	U	U	µg/Kg	67	201	3550/8270C
Nitrobenzene	U	U	µg/Kg	38	114	3550/8270C
Isophorone	U	U	µg/Kg	76	228	3550/8270C
2-Nitrophenol	U	U	µg/Kg	78	234	3550/8270C
2,4-Dimethylphenol	U	U	µg/Kg	72	216	3550/8270C
Bis (2-Chloroethoxy)methane	U	U	µg/Kg	81	243	3550/8270C
2,4-Dichlorophenol	U	U	µg/Kg	59	177	3550/8270C
1,2,3-Trichlorobenzene	U	U	µg/Kg	32	96	3550/8270C
1,2,4-Trichlorobenzene	U	U	µg/Kg	42	126	3550/8270C
Naphthalene	U	U	µg/Kg	1	3	3550/8270C
Hexachlorobutadiene	U	U	µg/Kg	14	42	3550/8270C
4-Chloro-3-Methylphenol	U	U	µg/Kg	66	198	3550/8270C
1-Methylnaphthalene	U	U	µg/Kg	1	3	3550/8270C
2-Methylnaphthlene	U	U	µg/Kg	1	3	3550/8270C
Hexachlorocyclopentadiene	U	U	µg/Kg	41	123	3550/8270C
2,3,6-Trichlorophenol	U	U	µg/Kg	98	294	3550/8270C
2,4,5-Trichlorophenol	U	U	µg/Kg	60	180	3550/8270C
2,4,6-Trichlorophenol	U	U	µg/Kg	53	159	3550/8270C
2-Chloronaphthalene	U	U	µg/Kg	34	102	3550/8270C
Dimethyl Phthalate	U	U	µg/Kg	38	114	3550/8270C
Acenaphthylene	U	U	µg/Kg	2.0	6.0	3550/8270C
2,6-Dinitrotoluene	U	U	µg/Kg	26	78	3550/8270C
Acenaphthene	U	U	µg/Kg	1.3	3.9	3550/8270C
2,4-Dinitrophenol	U	U	µg/Kg	34	102	3550/8270C

Petroleum Hydrocarbon Speciation Analysis (continued)						
PARAMETER	RESULT	QC	UNITS	MDL	PQL	METHOD
2,4-Dinitrotoluene	U	U	µg/Kg	41	123	3550/8270C
4-Nitrophenol	U	U	µg/Kg	37	111	3550/8270C
Diethyl Phthalate	U	U	µg/Kg	35	105	3550/8270C
Fluorene	U	U	µg/Kg	1.0	3.0	3550/8270C
4-Chlorophenyl Phenyl Ether	U	U	µg/Kg	45	135	3550/8270C
4,6-Dinitro-2-Methylphenol	U	U	µg/Kg	36	108	3550/8270C
N-Nitrosodiphenylamine	U	U	µg/Kg	51	153	3550/8270C
4-Bromophenyl Phenyl Ether	U	U	µg/Kg	38	114	3550/8270C
Hexachlorobenzene	U	U	µg/Kg	36	108	3550/8270C
Pentachlorophenol	U	U	µg/Kg	1.7	5.1	3550/8270C
Phenanthrene	U	U	µg/Kg	2	6	3550/8270C
Anthracene	U	U	µg/Kg	0.6	1.8	3550/8270C
Di-N-Butyl Phthalate	U	U	µg/Kg	34	102	3550/8270C
Fluoranthene	U	U	µg/Kg	1.6	4.8	3550/8270C
Benzidine	U	U	µg/Kg	33	99	3550/8270C
Pyrene	16.0		µg/Kg	2	6	3550/8270C
Butyl Benzyl Phthalate	U	U	µg/Kg	50	150	3550/8270C
Benzo(A)Anthracene	5.74		µg/Kg	1	3	3550/8270C
3,3-Dichlorobenzidine	U	U	µg/Kg	100	300	3550/8270C
Chrysene	7.36		µg/Kg	1	3	3550/8270C
Bis (2 Ethylhexyl) Phthalate	U	U	µg/Kg	39	117	3550/8270C
Di-N-Octyl Phthalate	U	U	µg/Kg	44	132	3550/8270C
Benzo(B)Fluoranthene	15.5		µg/Kg	1	3	3550/8270C
Benzo(K)Fluoranthene	U	U	µg/Kg	1	3	3550/8270C
Benzo(A)Pyrene	14.9		µg/Kg	1	3	3550/8270C
Indeno(1,2,3-CD)Pyrene	U	U	µg/Kg	2	6	3550/8270C
Dibenzo (A,H) Anthracene	1.92		µg/Kg	2	6	3550/8270C
Benzo(G,H,I)Perylene	U	U	µg/Kg	2	6	3550/8270C
Bis-2-ethylhexyl Adipate	U	U	µg/Kg	33	99	3550/8270C
Aldrin	U	U	µg/Kg	1.0	3.0	3550/8270C
-BHC	U	U	µg/Kg	3.0	9.0	3550/8270C
-BHC	U	U	µg/Kg	3.0	9.0	3550/8270C
-BHC	U	U	µg/Kg	3.0	9.0	3550/8270C
-BHC (Lindane)	U	U	µg/Kg	1.0	3.0	3550/8270C
Clordane	U	U	µg/Kg	1.0	3.0	3550/8270C
4,4'-DDD	U	U	µg/Kg	2	6	3550/8270C
4,4'-DDE	U	U	µg/Kg	1.39	4017	3550/8270C
4,4'-DDT	U	U	µg/Kg	1.69	5.07	3550/8270C

Petroleum Hydrocarbon Speciation Analysis (continued)						
PARAMETER	RESULT	QC	UNITS	MDL	PQL	METHOD
PCB-1248	U	U	µg/Kg	0.30	0.90	3550/8270C
PCB-1254	U	U	µg/Kg	0.30	0.90	3550/8270C
PCB-1260	U	U	µg/Kg	0.30	0.90	3550/8270C
Dioxin	U	U	µg/Kg	30	90	3550/8270C
Azobenzene	U	U	µg/Kg	30	90	3550/8270C
Methoxychlor	U	U	µg/Kg	19	57	3550/8270C
Benzoic Acid	U	U	µg/Kg	30	90	3550/8270C
Aniline	U	U	µg/Kg	30	90	3550/8270C
4-Chloroaniline	U	U	µg/Kg	11	33	3550/8270C
Dibenzofuran	U	U	µg/Kg	30	90	3550/8270C
2-Nitroaniline	U	U	µg/Kg	37	111	3550/8270C
30Nitroaniline	U	U	µg/Kg	30	90	3550/8270C
4-Nitroaniline	U	U	µg/Kg	30	90	3550/8270C
Carbazole	U	U	µg/Kg	30	90	3550/8270C
2,6-Dichlorophenol	U	U	µg/Kg	17	51	3550/8270C
2,3,4,6-Tetrachlorophenol	U	U	µg/Kg	30	90	3550/8270C
2,3,5,6-Tetrachlorophenol	U	U	µg/Kg	30	90	3550/8270C
Pyridine	U	U	µg/Kg	67	201	3550/8270C
FL-PRO (Petroleum Residual Organic Totals) Soil Dilution Factor = 1						
TOTAL PRO (C8-C40)	32.6		mg/Kg	0.01	0.03	FL-PRO
TPHCWG TPH-CWG Speciation Method (Soils) Dilution Factor = 1						
C5-C7 Aromatics	U	U	µg/Kg	5.0	15.0	TPHCWG
C7-C8 Aromatics	U	U	µg/Kg	5.0	15.0	TPHCWG
C8-C10 Aromatics	U	U	µg/Kg	5.0	15.0	TPHCWG
C10-C12 Aromatics	U	U	µg/Kg	5.0	15.0	TPHCWG
C12-C16 Aromatics	U	U	µg/Kg	5.0	15.0	TPHCWG
C16-C21 Aromatics	59.5	U	µg/Kg	5.0	15.0	TPHCWG
C21-C35 Aromatics	U	U	µg/Kg	5.0	15.0	TPHCWG
C5-C6 Aliphatics	U	U	µg/Kg	5.0	15.0	TPHCWG
C6-C8 Aliphatics	U	U	µg/Kg	5.0	15.0	TPHCWG
C8-C10 Aliphatics	U	U	µg/Kg	5.0	15.0	TPHCWG
C10-C12 Aliphatics	U	U	µg/Kg	5.0	15.0	TPHCWG
C12-C16 Aliphatics	U	U	µg/Kg	5.0	15.0	TPHCWG
C16-C35 Aliphatics	32600	I	µg/Kg	5.0	15.0	TPHCWG

QC=Qualifier Code as defined by DEP 62-160; U=Undetected; MDL=Minimum Detection Limit; PQL=Practical Quantization Limit.

BLIND PASS SEDIMENT CORE BP-81 (312-317 cm)



Red circle indicates area sampled for GC/MS analysis.

C₈-C₄₀ Table						
PARAMETER	RESULT	QC	UNITS	MDL	PQL	METHOD
Percent Solids	84.1		%	0.1	0.3	EPA 160.3
FL-PRO (Petroleum Residual Organic Totals) Soil Dilution Factor = 1						
TOTAL PRO (C8-C40)	346.0		mg/Kg	0.01	0.03	FL-PRO

QC=Qualifier Code as defined by DEP 62-160; U=Undetected; I=In between the MDL and PQL; Q= Out of hold; MDL=Minimum Detection Limit; PQL=Practical Quantation Limit.

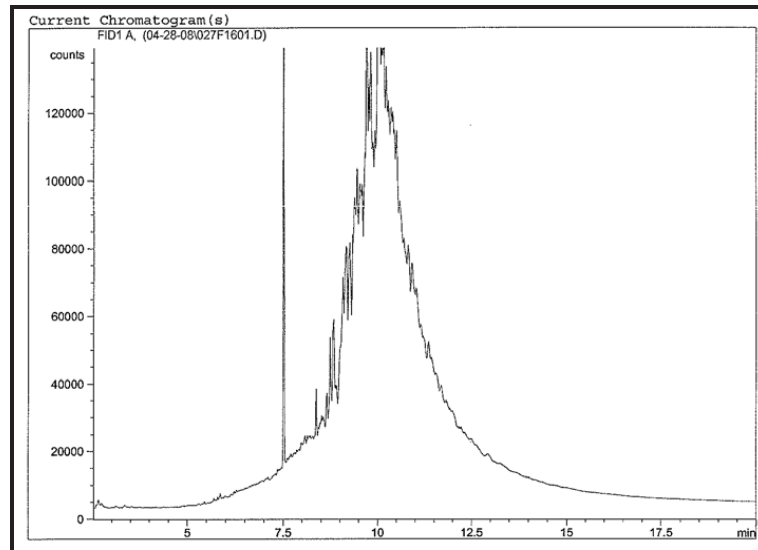

Chromatogram for sediment core BP-81 (312-317 cm).

Petroleum Hydrocarbon Speciation Analysis						
PARAMETER	RESULT	QC	UNITS	MDL	PQL	METHOD
Percent Solids	84.1		%	0.1	0.3	EPA 160.3
8260B VOA Compounds in Solids & Wastes GC/MS Dilution Factor = 1						
Methyl-tert-butyl-ether	U	Q	µg/Kg	0.7	2.1	5035/8260B
Methyl Ether Ketone	U	Q	µg/Kg	1.0	3.1	5035/8260B
Benzene	U	U	µg/Kg	0.5	1.6	5035/8260B
Toluene	U	U	µg/Kg	0.5	1.5	5035/8260B
Chlorobenzene	U	U	µg/Kg	0.7	2.1	5035/8260B
Ethylbenzene	U	U	µg/Kg	0.7	2.1	5035/8260B
M & p Xylene	U	U	µg/Kg	1.5	4.5	5035/8260B
o-Xylene	U	U	µg/Kg	0.7	2.1	5035/8260B
1,3-Dichlorobenzene	U	U	µg/Kg	1.0	3.0	5035/8260B
1,4-Dichlorobenzene	U	U	µg/Kg	0.8	2.4	5035/8260B
1,2-Dichlorobenzene	U	U	µg/Kg	0.7	2.1	5035/8260B
8270C Semivolatile Organics in Solids by GC/MS Dilution Factor = 1						
N-Nitrosodimethylamine	U	U	µg/Kg	69	207	3550/8270C
Phenol	U	U	µg/Kg	43	129	3550/8270C
2-Methyl Phenol (o-cresol)	U	U	µg/Kg	62	186	3550/8270C
3-Methyl Phenol (m-cresol)	U	U	µg/Kg	46	138	3550/8270C
4-Methyl Phenol (p-cresol)	U	U	µg/Kg	37	111	3550/8270C
Bis (2-Chloroethyl) Ether	U	U	µg/Kg	47	141	3550/8270C
2-Chlorophenol	U	U	µg/Kg	27.0	81.0	3550/8270C
1,3-Dichlorobenzene	U	U	µg/Kg	3.2	9.6	3550/8270C
1,4-Dichlorobenzene	U	U	µg/Kg	2.0	6.0	3550/8270C
Benzyl Alcohol	U	U	µg/Kg	3	9	3550/8270C
1,2-Dichlorobenzene	U	U	µg/Kg	3.5	10.5	3550/8270C
Bis (2-Chloroisopropyl) Ether	U	U	µg/Kg	47	141	3550/8270C
N-Nitrosodi-N-Propylamine	U	U	µg/Kg	24.0	72.0	3550/8270C
Hexachloroethane	U	U	µg/Kg	67	201	3550/8270C
Nitrobenzene	U	U	µg/Kg	38	114	3550/8270C
Isophorone	U	U	µg/Kg	76	228	3550/8270C
2-Nitrophenol	U	U	µg/Kg	78	234	3550/8270C
2,4-Dimethylphenol	U	U	µg/Kg	72	216	3550/8270C
Bis (2-Chloroethoxy)methane	U	U	µg/Kg	81	243	3550/8270C
2,4-Dichlorophenol	U	U	µg/Kg	59	177	3550/8270C
1,2,3-Trichlorobenzene	U	U	µg/Kg	32	96	3550/8270C
1,2,4-Trichlorobenzene	U	U	µg/Kg	42	126	3550/8270C
Naphthalene	U	U	µg/Kg	1	3	3550/8270C
Hexachlorobutadiene	U	U	µg/Kg	14	42	3550/8270C
4-Chloro-3-Methylphenol	U	U	µg/Kg	66	198	3550/8270C
1-Methylnaphthalene	U	U	µg/Kg	1	3	3550/8270C
2-Methylnaphthlene	U	U	µg/Kg	1	3	3550/8270C
Hexachlorocyclopentadiene	U	U	µg/Kg	41	123	3550/8270C
2,3,6-Trichlorophenol	U	U	µg/Kg	98	294	3550/8270C
2,4,5-Trichlorophenol	U	U	µg/Kg	60	180	3550/8270C
2,4,6-Trichlorophenol	U	U	µg/Kg	53	159	3550/8270C
2-Chloronaphthalene	U	U	µg/Kg	34	102	3550/8270C
Dimethyl Phthalate	U	U	µg/Kg	38	114	3550/8270C
Acenaphthylene	3.22	U	µg/Kg	2.0	6.0	3550/8270C
2,6-Dinitrotoluene	U	U	µg/Kg	26	78	3550/8270C
Acenaphthene	U	U	µg/Kg	1.3	3.9	3550/8270C

Petroleum Hydrocarbon Speciation Analysis (continued)						
PARAMETER	RESULT	QC	UNITS	MDL	PQL	METHOD
2,4-Dinitrotoluene	U	U	µg/Kg	41	123	3550/8270C
4-Nitrophenol	U	U	µg/Kg	37	111	3550/8270C
Diethyl Phthalate	U	U	µg/Kg	35	105	3550/8270C
Fluorene	U	U	µg/Kg	1.0	3.0	3550/8270C
4-Chlorophenyl Phenyl Ether	U	U	µg/Kg	45	135	3550/8270C
4,6-Dinitro-2-Methylphenol	U	U	µg/Kg	36	108	3550/8270C
N-Nitrosodiphenylamine	U	U	µg/Kg	51	153	3550/8270C
4-Bromophenyl Phenyl Ether	U	U	µg/Kg	38	114	3550/8270C
Hexachlorobenzene	U	U	µg/Kg	36	108	3550/8270C
Pentachlorophenol	U	U	µg/Kg	1.7	5.1	3550/8270C
Phenanthrene	U	U	µg/Kg	2	6	3550/8270C
Anthracene	U	U	µg/Kg	0.6	1.8	3550/8270C
Di-N-Butyl Phthalate	U	U	µg/Kg	34	102	3550/8270C
Fluoranthene	U	U	µg/Kg	1.6	4.8	3550/8270C
Benzidine	U	U	µg/Kg	33	99	3550/8270C
Pyrene	23.0	U	µg/Kg	2	6	3550/8270C
Butyl Benzyl Phthalate	U	U	µg/Kg	50	150	3550/8270C
Benzo(A)Anthracene	7.19	U	µg/Kg	1	3	3550/8270C
3,3-Dichlorobenzidine	U	U	µg/Kg	100	300	3550/8270C
Chrysene	13.9	U	µg/Kg	1	3	3550/8270C
Bis (2 Ethylhexyl) Phthalate	U	U	µg/Kg	39	117	3550/8270C
Di-N-Octyl Phthalate	U	U	µg/Kg	44	132	3550/8270C
Benzo(B)Fluoranthene	50.0	U	µg/Kg	1	3	3550/8270C
Benzo(K)Fluoranthene	7.13	U	µg/Kg	1	3	3550/8270C
Benzo(A)Pyrene	64.7	U	µg/Kg	1	3	3550/8270C
Indeno(1,2,3-CD)Pyrene	20.1	U	µg/Kg	2	6	3550/8270C
Dibenzo (A,H) Anthracene	16.5	U	µg/Kg	2	6	3550/8270C
Benzo(G,H,I)Perylene	25.0	U	µg/Kg	2	6	3550/8270C
Bis-2-ethylhexyl Adipate	U	U	µg/Kg	33	99	3550/8270C
Aldrin	U	U	µg/Kg	1.0	3.0	3550/8270C
-BHC	U	U	µg/Kg	3.0	9.0	3550/8270C
-BHC	U	U	µg/Kg	3.0	9.0	3550/8270C
-BHC	U	U	µg/Kg	3.0	9.0	3550/8270C
-BHC (Lindane)	U	U	µg/Kg	1.0	3.0	3550/8270C
Clordane	U	U	µg/Kg	1.0	3.0	3550/8270C
4,4'-DDD	U	U	µg/Kg	2	6	3550/8270C
4,4'-DDE	U	U	µg/Kg	1.39	4017	3550/8270C
4,4'-DDT	U	U	µg/Kg	1.69	5.07	3550/8270C
Dieldrin	U	U	µg/Kg	0.840	2.520	3550/8270C
Endosulfan I	U	U	µg/Kg	1.100	3.300	3550/8270C
Endosulfan II	U	U	µg/Kg	1.60	4.80	3550/8270C
Endosulfan Sulfate	U	U	µg/Kg	1.70	5.10	3550/8270C
Endrin	U	U	µg/Kg	1.800	5.400	3550/8270C
Endrin Aldehyde	U	U	µg/Kg	1.900	5.700	3550/8270C
Heptachlor	U	U	µg/Kg	1.78	5.34	3550/8270C
Heptachlor Epoxide	U	U	µg/Kg	1.68	5.04	3550/8270C
Toxaphene	U	U	µg/Kg	1.90	5.70	3550/8270C
PCB-1016	U	U	µg/Kg	0.30	0.90	3550/8270C
PCB-1221	U	U	µg/Kg	0.30	0.90	3550/8270C
PCB-1232	U	U	µg/Kg	0.30	0.90	3550/8270C
PCB-1242	U	U	µg/Kg	0.30	0.90	3550/8270C

Petroleum Hydrocarbon Speciation Analysis (continued)						
PARAMETER	RESULT	QC	UNITS	MDL	PQL	METHOD
PCB-1248	U	U	µg/Kg	0.30	0.90	3550/8270C
PCB-1254	U	U	µg/Kg	0.30	0.90	3550/8270C
PCB-1260	U	U	µg/Kg	0.30	0.90	3550/8270C
Dioxin	U	U	µg/Kg	30	90	3550/8270C
Azobenzene	U	U	µg/Kg	30	90	3550/8270C
Methoxychlor	U	U	µg/Kg	19	57	3550/8270C
Benzoic Acid	U	U	µg/Kg	30	90	3550/8270C
Aniline	U	U	µg/Kg	30	90	3550/8270C
4-Chloroaniline	U	U	µg/Kg	11	33	3550/8270C
Dibenzofuran	U	U	µg/Kg	30	90	3550/8270C
2-Nitroaniline	U	U	µg/Kg	37	111	3550/8270C
30Nitroaniline	U	U	µg/Kg	30	90	3550/8270C
4-Nitroaniline	U	U	µg/Kg	30	90	3550/8270C
Carbazole	U	U	µg/Kg	30	90	3550/8270C
2,6-Dichlorophenol	U	U	µg/Kg	17	51	3550/8270C
2,3,4,6-Tetrachlorophenol	U	U	µg/Kg	30	90	3550/8270C
2,3,5,6-Tetrachlorophenol	U	U	µg/Kg	30	90	3550/8270C
Pyridine	U	U	µg/Kg	67	201	3550/8270C
FL-PRO (Petroleum Residual Organic Totals) Soil Dilution Factor = 1						
TOTAL PRO (C8-C40)	346		mg/Kg	0.01	0.03	FL-PRO
TPHCWG TPH-CWG Speciation Method (Soils) Dilution Factor = 1						
C5-C7 Aromatics	U	U	µg/Kg	5.0	15.0	TPHCWG
C7-C8 Aromatics	U	U	µg/Kg	5.0	15.0	TPHCWG
C8-C10 Aromatics	U	U	µg/Kg	5.0	15.0	TPHCWG
C10-C12 Aromatics	U	U	µg/Kg	5.0	15.0	TPHCWG
C12-C16 Aromatics	13.5	U	µg/Kg	5.0	15.0	TPHCWG
C16-C21 Aromatics	168	U	µg/Kg	5.0	15.0	TPHCWG
C21-C35 Aromatics	61.6	U	µg/Kg	5.0	15.0	TPHCWG
C5-C6 Aliphatics	U	U	µg/Kg	5.0	15.0	TPHCWG
C6-C8 Aliphatics	U	U	µg/Kg	5.0	15.0	TPHCWG
C8-C10 Aliphatics	U	U	µg/Kg	5.0	15.0	TPHCWG
C10-C12 Aliphatics	U	U	µg/Kg	5.0	15.0	TPHCWG
C12-C16 Aliphatics	U	U	µg/Kg	5.0	15.0	TPHCWG
C16-C35 Aliphatics	357000	U	µg/Kg	5.0	15.0	TPHCWG

QC=Qualifier Code as defined by DEP 62-160; U=Undetected; MDL=Minimum Detection Limit; PQL=Practical Quantation Limit.

BLIND PASS SEDIMENT CORE BP-81 (328-338 cm)



Red circle indicates area sampled for GC/MS analysis.

C₈-C₄₀ Table						
PARAMETER	RESULT	QC	UNITS	MDL	PQL	METHOD
Percent Solids	87.5		%	0.1	0.3	EPA 160.3
FL-PRO (Petroleum Residual Organic Totals) Soil Dilution Factor = 1						
TOTAL PRO (C8-C40)	7.17		mg/Kg	0.01	0.03	FL-PRO

QC=Qualifier Code as defined by DEP 62-160; U=Undetected; I=In between the MDL and PQL; Q= Out of hold; MDL=Minimum Detection Limit; PQL=Practical Quantation Limit.

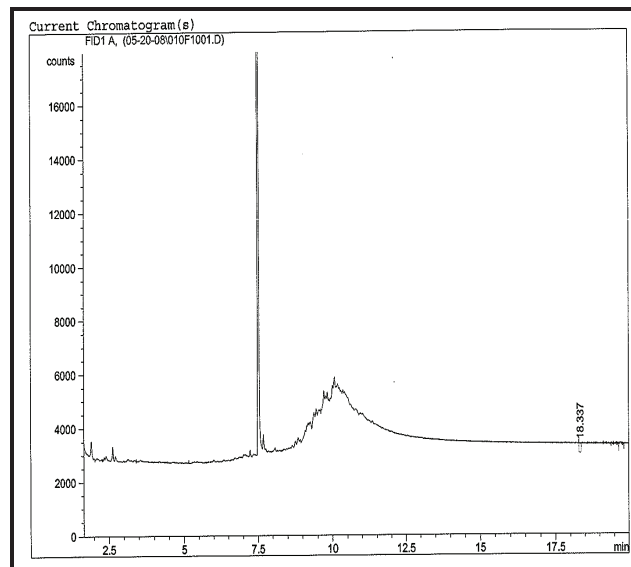

Chromatogram for sediment core BP-81 (328-338 cm).

Petroleum Hydrocarbon Speciation Analysis						
PARAMETER	RESULT	QC	UNITS	MDL	PQL	METHOD
Percent Solids	87.5		%	0.1	0.3	EPA 160.3
8260B VOA Compounds in Solids & Wastes GC/MS Dilution Factor = 1						
Methyl-tert-butyl-ether	U	U	µg/Kg	1.9	5.7	5030/8260B
Benzene	U	U	µg/Kg	0.85	2.55	5030/8260B
Toluene	U	U	µg/Kg	1.4	4.2	5030/8260B
Chlorobenzene	U	U	µg/Kg	2.3	6.9	5030/8260B
Ethylbenzene	U	U	µg/Kg	1.5	4.5	5030/8260B
M & p Xylene	U	U	µg/Kg	1.3	3.9	5030/8260B
o-Xylene	U	U	µg/Kg	1.1	3.3	5030/8260B
1,3-Dichlorobenzene	U	U	µg/Kg	3.2	9.6	5030/8260B
1,4-Dichlorobenzene	U	U	µg/Kg	2.0	6.0	5030/8260B
1,2-Dichlorobenzene	U	U	µg/Kg	3.5	10.5	5030/8260B
8270C Semivolatile Organics in Solids by GC/MS Dilution Factor = 1						
N-Nitrosodimethylamine	U	U	µg/Kg	69	207	3550/8270C
Phenol	U	U	µg/Kg	43	129	3550/8270C
2-Methyl Phenol (o-cresol)	U	U	µg/Kg	62	186	3550/8270C
3-Methyl Phenol (m-cresol)	U	U	µg/Kg	46	138	3550/8270C
4-Methyl Phenol (p-cresol)	U	U	µg/Kg	37	111	3550/8270C
Bis (2-Chloroethyl) Ether	U	U	µg/Kg	47	141	3550/8270C
2-Chlorophenol	U	U	µg/Kg	27.0	81.0	3550/8270C
1,3-Dichlorobenzene	U	U	µg/Kg	3.2	9.6	3550/8270C
1,4-Dichlorobenzene	U	U	µg/Kg	2.0	6.0	3550/8270C
Benzyl Alcohol	U	U	µg/Kg	3	9	3550/8270C
1,2-Dichlorobenzene	U	U	µg/Kg	3.5	10.5	3550/8270C
Bis (2-Chloroisopropyl) Ether	U	U	µg/Kg	47	141	3550/8270C
N-Nitrosodi-N-Proplamine	U	U	µg/Kg	24.0	72.0	3550/8270C
Hexachloroethane	U	U	µg/Kg	67	201	3550/8270C
Nitrobenzene	U	U	µg/Kg	38	114	3550/8270C
Isophorone	U	U	µg/Kg	76	228	3550/8270C
2-Nitrophenol	U	U	µg/Kg	78	234	3550/8270C
2,4-Dimethylphenol	U	U	µg/Kg	72	216	3550/8270C
Bis (2-Chloroethoxy)methane	U	U	µg/Kg	81	243	3550/8270C
2,4-Dichlorophenol	U	U	µg/Kg	59	177	3550/8270C
1,2,3-Trichlorobenzene	U	U	µg/Kg	32	96	3550/8270C
1,2,4-Trichlorobenzene	U	U	µg/Kg	42	126	3550/8270C
Naphthalene	U	U	µg/Kg	1	3	3550/8270C
Hexachlorobutadiene	U	U	µg/Kg	14	42	3550/8270C
4-Chloro-3-Methylphenol	U	U	µg/Kg	66	198	3550/8270C
1-Methylnaphthalene	U	U	µg/Kg	1	3	3550/8270C
2-Methylnaphthlene	U	U	µg/Kg	1	3	3550/8270C
Hexachlorocyclopentadiene	U	U	µg/Kg	41	123	3550/8270C
2,3,6-Trichlorophenol	U	U	µg/Kg	98	294	3550/8270C
2,4,5-Trichlorophenol	U	U	µg/Kg	60	180	3550/8270C
2,4,6-Trichlorophenol	U	U	µg/Kg	53	159	3550/8270C
2-Chloronaphthalene	U	U	µg/Kg	34	102	3550/8270C
Dimethyl Phthalate	U	U	µg/Kg	38	114	3550/8270C
Acenaphthylene	U	U	µg/Kg	2.0	6.0	3550/8270C
2,6-Dinitrotoluene	U	U	µg/Kg	26	78	3550/8270C
Acenaphthene	U	U	µg/Kg	1.3	3.9	3550/8270C
2,4-Dinitrophenol	U	U	µg/Kg	34	102	3550/8270C

Petroleum Hydrocarbon Speciation Analysis (continued)						
PARAMETER	RESULT	QC	UNITS	MDL	PQL	METHOD
2,4-Dinitrotoluene	U	U	µg/Kg	41	123	3550/8270C
4-Nitrophenol	U	U	µg/Kg	37	111	3550/8270C
Diethyl Phthalate	U	U	µg/Kg	35	105	3550/8270C
Fluorene	U	U	µg/Kg	1.0	3.0	3550/8270C
4-Chlorophenyl Phenyl Ether	U	U	µg/Kg	45	135	3550/8270C
4,6-Dinitro-2-Methylphenol	U	U	µg/Kg	36	108	3550/8270C
N-Nitrosodiphenylamine	U	U	µg/Kg	51	153	3550/8270C
4-Bromophenyl Phenyl Ether	U	U	µg/Kg	38	114	3550/8270C
Hexachlorobenzene	U	U	µg/Kg	36	108	3550/8270C
Pentachlorophenol	U	U	µg/Kg	1.7	5.1	3550/8270C
Phenanthrene	U	U	µg/Kg	2	6	3550/8270C
Anthracene	U	U	µg/Kg	0.6	1.8	3550/8270C
Di-N-Butyl Phthalate	U	U	µg/Kg	34	102	3550/8270C
Fluoranthene	U	U	µg/Kg	1.6	4.8	3550/8270C
Benzidine	U	U	µg/Kg	33	99	3550/8270C
Pyrene	U	U	µg/Kg	2	6	3550/8270C
Butyl Benzyl Phthalate	U	U	µg/Kg	50	150	3550/8270C
Benzo(A)Anthracene	U	U	µg/Kg	1	3	3550/8270C
3,3-Dichlorobenzidine	U	U	µg/Kg	100	300	3550/8270C
Chrysene	U	U	µg/Kg	1	3	3550/8270C
Bis (2 Ethylhexyl) Phthalate	U	U	µg/Kg	39	117	3550/8270C
Di-N-Octyl Phthalate	U	U	µg/Kg	44	132	3550/8270C
Benzo(B)Fluoranthene	1.55		µg/Kg	1	3	3550/8270C
Benzo(K)Fluoranthene	U	U	µg/Kg	1	3	3550/8270C
Benzo(A)Pyrene	1.70		µg/Kg	1	3	3550/8270C
Indeno(1,2,3-CD)Pyrene	U	U	µg/Kg	2	6	3550/8270C
Dibenzo (A,H) Anthracene	U	U	µg/Kg	2	6	3550/8270C
Benzo(G,H,I)Perylene	U	U	µg/Kg	2	6	3550/8270C
Bis-2-ethylexyl Adipate	U	U	µg/Kg	33	99	3550/8270C
Aldrin	U	U	µg/Kg	1.0	3.0	3550/8270C
-BHC	U	U	µg/Kg	3.0	9.0	3550/8270C
-BHC	U	U	µg/Kg	3.0	9.0	3550/8270C
-BHC	U	U	µg/Kg	3.0	9.0	3550/8270C
-BHC (Lindane)	U	U	µg/Kg	1.0	3.0	3550/8270C
Clordane	U	U	µg/Kg	1.0	3.0	3550/8270C
4,4'-DDD	U	U	µg/Kg	2	6	3550/8270C
4,4'-DDE	U	U	µg/Kg	1.39	4017	3550/8270C
4,4'-DDT	U	U	µg/Kg	1.69	5.07	3550/8270C
Dieldrin	U	U	µg/Kg	0.840	2.520	3550/8270C
Endosulfan I	U	U	µg/Kg	1.100	3.300	3550/8270C
Endosulfan II	U	U	µg/Kg	1.60	4.80	3550/8270C
Endosulfan Sulfate	U	U	µg/Kg	1.70	5.10	3550/8270C
Endrin	U	U	µg/Kg	1.800	5.400	3550/8270C
Endrin Aldehyde	U	U	µg/Kg	1.900	5.700	3550/8270C
Heptachlor	U	U	µg/Kg	1.78	5.34	3550/8270C
Heptachlor Epoxide	U	U	µg/Kg	1.68	5.04	3550/8270C
Toxaphene	U	U	µg/Kg	1.90	5.70	3550/8270C
PCB-1016	U	U	µg/Kg	0.30	0.90	3550/8270C
PCB-1221	U	U	µg/Kg	0.30	0.90	3550/8270C
PCB-1232	U	U	µg/Kg	0.30	0.90	3550/8270C
PCB-1242	U	U	µg/Kg	0.30	0.90	3550/8270C

Petroleum Hydrocarbon Speciation Analysis (continued)						
PARAMETER	RESULT	QC	UNITS	MDL	PQL	METHOD
PCB-1248	U	U	µg/Kg	0.30	0.90	3550/8270C
PCB-1254	U	U	µg/Kg	0.30	0.90	3550/8270C
PCB-1260	U	U	µg/Kg	0.30	0.90	3550/8270C
Dioxin	U	U	µg/Kg	30	90	3550/8270C
Azobenzene	U	U	µg/Kg	30	90	3550/8270C
Methoxychlor	U	U	µg/Kg	19	57	3550/8270C
Benzoic Acid	U	U	µg/Kg	30	90	3550/8270C
Aniline	U	U	µg/Kg	30	90	3550/8270C
4-Chloroaniline	U	U	µg/Kg	11	33	3550/8270C
Dibenzofuran	U	U	µg/Kg	30	90	3550/8270C
2-Nitroaniline	U	U	µg/Kg	37	111	3550/8270C
30Nitroaniline	U	U	µg/Kg	30	90	3550/8270C
4-Nitroaniline	U	U	µg/Kg	30	90	3550/8270C
Carbazole	U	U	µg/Kg	30	90	3550/8270C
2,6-Dichlorophenol	U	U	µg/Kg	17	51	3550/8270C
2,3,4,6-Tetrachlorophenol	U	U	µg/Kg	30	90	3550/8270C
2,3,5,6-Tetrachlorophenol	U	U	µg/Kg	30	90	3550/8270C
Pyridine	U	U	µg/Kg	67	201	3550/8270C
FL-PRO (Petroleum Residual Organic Totals) Soil Dilution Factor = 1						
TOTAL PRO (C8-C40)	7.17		mg/Kg	0.01	0.03	FL-PRO
TPHCWG TPH-CWG Speciation Method (Soils) Dilution Factor = 1						
C5-C7 Aromatics	U	U	µg/Kg	5.0	15.0	TPHCWG
C7-C8 Aromatics	U	U	µg/Kg	5.0	15.0	TPHCWG
C8-C10 Aromatics	U	U	µg/Kg	5.0	15.0	TPHCWG
C10-C12 Aromatics	U	U	µg/Kg	5.0	15.0	TPHCWG
C12-C16 Aromatics	U	U	µg/Kg	5.0	15.0	TPHCWG
C16-C21 Aromatics	U	U	µg/Kg	5.0	15.0	TPHCWG
C21-C35 Aromatics	U	U	µg/Kg	5.0	15.0	TPHCWG
C5-C6 Aliphatics	U	U	µg/Kg	5.0	15.0	TPHCWG
C6-C8 Aliphatics	U	U	µg/Kg	5.0	15.0	TPHCWG
C8-C10 Aliphatics	U	U	µg/Kg	5.0	15.0	TPHCWG
C10-C12 Aliphatics	U	U	µg/Kg	5.0	15.0	TPHCWG
C12-C16 Aliphatics	U	U	µg/Kg	5.0	15.0	TPHCWG
C16-C35 Aliphatics	7170		µg/Kg	5.0	15.0	TPHCWG

QC=Qualifier Code as defined by DEP 62-160; U=Undetected; MDL=Minimum Detection Limit; PQL=Practical Quantization Limit.

BLIND PASS SEDIMENT CORE BP-83 (70-75 cm)



Red circle indicates area sampled for GC/MS analysis.

C₈-C₄₀ Table						
PARAMETER	RESULT	QC	UNITS	MDL	PQL	METHOD
Percent Solids	71.1		%	0.1	0.3	EPA 160.3
FL-PRO (Petroleum Residual Organic Totals) Soil Dilution Factor = 1						
TOTAL PRO (C8-C40)	10.9		mg/Kg	0.01	0.03	FL-PRO

QC=Qualifier Code as defined by DEP 62-160; U=Undetected; I=In between the MDL and PQL; Q= Out of hold; MDL=Minimum Detection Limit; PQL=Practical Quantation Limit.

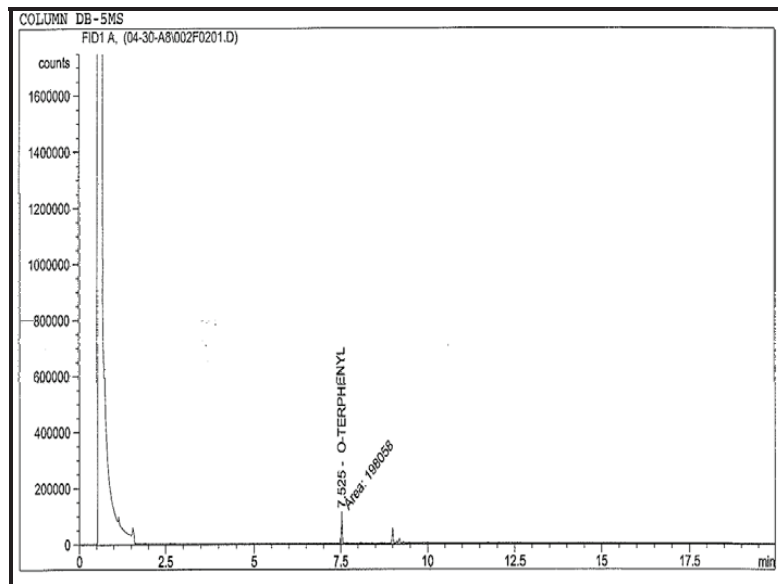

Chromatogram for sediment core BP-83 (70-75 cm).

Petroleum Hydrocarbon Speciation Analysis						
PARAMETER	RESULT	QC	UNITS	MDL	PQL	METHOD
Percent Solids	71.1		%	0.1	0.3	EPA 160.3
8260B VOA Compounds in Solids & Wastes GC/MS Dilution Factor = 1						
Methyl-tert-butyl-ether	4.52	Q	µg/Kg	0.7	2.1	5035/8260B
Methyl Ether Ketone	1.42	Q	µg/Kg	1.0	3.1	5035/8260B
Benzene	U	U	µg/Kg	0.5	1.6	5035/8260B
Toluene	U	U	µg/Kg	0.5	1.5	5035/8260B
Chlorobenzene	U	U	µg/Kg	0.7	2.1	5035/8260B
Ethylbenzene	U	U	µg/Kg	0.7	2.1	5035/8260B
M & p Xylene	U	U	µg/Kg	1.5	4.5	5035/8260B
o-Xylene	U	U	µg/Kg	0.7	2.1	5035/8260B
1,3-Dichlorobenzene	U	U	µg/Kg	1.0	3.0	5035/8260B
1,4-Dichlorobenzene	U	U	µg/Kg	0.8	2.4	5035/8260B
1,2-Dichlorobenzene	U	U	µg/Kg	0.7	2.1	5035/8260B
8270C Semivolatile Organics in Solids by GC/MS Dilution Factor = 1						
N-Nitrosodimethylamine	U	U	µg/Kg	69	207	3550/8270C
Phenol	U	U	µg/Kg	43	129	3550/8270C
2-Methyl Phenol (o-cresol)	U	U	µg/Kg	62	186	3550/8270C
3-Methyl Phenol (m-cresol)	U	U	µg/Kg	46	138	3550/8270C
4-Methyl Phenol (p-cresol)	U	U	µg/Kg	37	111	3550/8270C
Bis (2-Chloroethyl) Ether	U	U	µg/Kg	47	141	3550/8270C
2-Chlorophenol	U	U	µg/Kg	27.0	81.0	3550/8270C
1,3-Dichlorobenzene	U	U	µg/Kg	3.2	9.6	3550/8270C
1,4-Dichlorobenzene	U	U	µg/Kg	2.0	6.0	3550/8270C
Benzyl Alcohol	U	U	µg/Kg	3	9	3550/8270C
1,2-Dichlorobenzene	U	U	µg/Kg	3.5	10.5	3550/8270C
Bis (2-Chloroisopropyl) Ether	U	U	µg/Kg	47	141	3550/8270C
N-Nitrosodi-N-Proplamine	U	U	µg/Kg	24.0	72.0	3550/8270C
Hexachloroethane	U	U	µg/Kg	67	201	3550/8270C
Nitrobenzene	U	U	µg/Kg	38	114	3550/8270C
Isophorone	U	U	µg/Kg	76	228	3550/8270C
2-Nitrophenol	U	U	µg/Kg	78	234	3550/8270C
2,4-Dimethylphenol	U	U	µg/Kg	72	216	3550/8270C
Bis (2-Chloroethoxy)methane	U	U	µg/Kg	81	243	3550/8270C
2,4-Dichlorophenol	U	U	µg/Kg	59	177	3550/8270C
1,2,3-Trichlorobenzene	U	U	µg/Kg	32	96	3550/8270C
1,2,4-Trichlorobenzene	U	U	µg/Kg	42	126	3550/8270C
Naphthalene	10.6	U	µg/Kg	1	3	3550/8270C
Hexachlorobutadiene	U	U	µg/Kg	14	42	3550/8270C
4-Chloro-3-Methylphenol	U	U	µg/Kg	66	198	3550/8270C
1-Methylnaphthalene	U	U	µg/Kg	1	3	3550/8270C
2-Methylnaphthlene	U	U	µg/Kg	1	3	3550/8270C
Hexachlorocyclopentadiene	U	U	µg/Kg	41	123	3550/8270C
2,3,6-Trichlorophenol	U	U	µg/Kg	98	294	3550/8270C
2,4,5-Trichlorophenol	U	U	µg/Kg	60	180	3550/8270C
2,4,6-Trichlorophenol	U	U	µg/Kg	53	159	3550/8270C
2-Chloronaphthalene	U	U	µg/Kg	34	102	3550/8270C
Dimethyl Phthalate	U	U	µg/Kg	38	114	3550/8270C
Acenaphthylene	U	U	µg/Kg	2.0	6.0	3550/8270C
2,6-Dinitrotoluene	U	U	µg/Kg	26	78	3550/8270C
Acenaphthene	U	U	µg/Kg	1.3	3.9	3550/8270C

Petroleum Hydrocarbon Speciation Analysis (continued)						
PARAMETER	RESULT	QC	UNITS	MDL	PQL	METHOD
2,4-Dinitrotoluene	U	U	µg/Kg	41	123	3550/8270C
4-Nitrophenol	U	U	µg/Kg	37	111	3550/8270C
Diethyl Phthalate	U	U	µg/Kg	35	105	3550/8270C
Fluorene	U	U	µg/Kg	1.0	3.0	3550/8270C
4-Chlorophenyl Phenyl Ether	U	U	µg/Kg	45	135	3550/8270C
4,6-Dinitro-2-Methylphenol	U	U	µg/Kg	36	108	3550/8270C
N-Nitrosodiphenylamine	U	U	µg/Kg	51	153	3550/8270C
4-Bromophenyl Phenyl Ether	U	U	µg/Kg	38	114	3550/8270C
Hexachlorobenzene	U	U	µg/Kg	36	108	3550/8270C
Pentachlorophenol	U	U	µg/Kg	1.7	5.1	3550/8270C
Phenanthrene	U	U	µg/Kg	2	6	3550/8270C
Anthracene	U	U	µg/Kg	0.6	1.8	3550/8270C
Di-N-Butyl Phthalate	U	U	µg/Kg	34	102	3550/8270C
Fluoranthene	3.06	U	µg/Kg	1.6	4.8	3550/8270C
Benzidine	U	U	µg/Kg	33	99	3550/8270C
Pyrene	2.76	U	µg/Kg	2	6	3550/8270C
Butyl Benzyl Phthalate	U	U	µg/Kg	50	150	3550/8270C
Benzo(A)Anthracene	4.13	U	µg/Kg	1	3	3550/8270C
3,3-Dichlorobenzidine	U	U	µg/Kg	100	300	3550/8270C
Chrysene	9.23	U	µg/Kg	1	3	3550/8270C
Bis (2 Ethylhexyl) Phthalate	U	U	µg/Kg	39	117	3550/8270C
Di-N-Octyl Phthalate	U	U	µg/Kg	44	132	3550/8270C
Benzo(B)Fluoranthene	7.81	U	µg/Kg	1	3	3550/8270C
Benzo(K)Fluoranthene	5.48	U	µg/Kg	1	3	3550/8270C
Benzo(A)Pyrene	5.27	U	µg/Kg	1	3	3550/8270C
Indeno(1,2,3-CD)Pyrene	7.91	U	µg/Kg	2	6	3550/8270C
Dibenzo (A,H) Anthracene	U	U	µg/Kg	2	6	3550/8270C
Benzo(G,H,I)Perylene	2.02	U	µg/Kg	2	6	3550/8270C
Bis-2-ethylhexyl Adipate	U	U	µg/Kg	33	99	3550/8270C
Aldrin	U	U	µg/Kg	1.0	3.0	3550/8270C
-BHC	U	U	µg/Kg	3.0	9.0	3550/8270C
-BHC	U	U	µg/Kg	3.0	9.0	3550/8270C
-BHC	U	U	µg/Kg	3.0	9.0	3550/8270C
-BHC (Lindane)	U	U	µg/Kg	1.0	3.0	3550/8270C
Clordane	U	U	µg/Kg	1.0	3.0	3550/8270C
4,4'-DDD	U	U	µg/Kg	2	6	3550/8270C
4,4'-DDE	U	U	µg/Kg	1.39	4017	3550/8270C
4,4'-DDT	U	U	µg/Kg	1.69	5.07	3550/8270C
Dieldrin	U	U	µg/Kg	0.840	2.520	3550/8270C
Endosulfan I	U	U	µg/Kg	1.100	3.300	3550/8270C
Endosulfan II	U	U	µg/Kg	1.60	4.80	3550/8270C
Endosulfan Sulfate	U	U	µg/Kg	1.70	5.10	3550/8270C
Endrin	U	U	µg/Kg	1.800	5.400	3550/8270C
Endrin Aldehyde	U	U	µg/Kg	1.900	5.700	3550/8270C
Heptachlor	U	U	µg/Kg	1.78	5.34	3550/8270C
Heptachlor Epoxide	U	U	µg/Kg	1.68	5.04	3550/8270C
Toxaphene	U	U	µg/Kg	1.90	5.70	3550/8270C
PCB-1016	U	U	µg/Kg	0.30	0.90	3550/8270C
PCB-1221	U	U	µg/Kg	0.30	0.90	3550/8270C
PCB-1232	U	U	µg/Kg	0.30	0.90	3550/8270C
PCB-1242	U	U	µg/Kg	0.30	0.90	3550/8270C

Petroleum Hydrocarbon Speciation Analysis (continued)						
PARAMETER	RESULT	QC	UNITS	MDL	PQL	METHOD
PCB-1248	U	U	µg/Kg	0.30	0.90	3550/8270C
PCB-1254	U	U	µg/Kg	0.30	0.90	3550/8270C
PCB-1260	U	U	µg/Kg	0.30	0.90	3550/8270C
Dioxin	U	U	µg/Kg	30	90	3550/8270C
Azobenzene	U	U	µg/Kg	30	90	3550/8270C
Methoxychlor	U	U	µg/Kg	19	57	3550/8270C
Benzoic Acid	U	U	µg/Kg	30	90	3550/8270C
Aniline	U	U	µg/Kg	30	90	3550/8270C
4-Chloroaniline	U	U	µg/Kg	11	33	3550/8270C
Dibenzofuran	U	U	µg/Kg	30	90	3550/8270C
2-Nitroaniline	U	U	µg/Kg	37	111	3550/8270C
30Nitroaniline	U	U	µg/Kg	30	90	3550/8270C
4-Nitroaniline	U	U	µg/Kg	30	90	3550/8270C
Carbazole	U	U	µg/Kg	30	90	3550/8270C
2,6-Dichlorophenol	U	U	µg/Kg	17	51	3550/8270C
2,3,4,6-Tetrachlorophenol	U	U	µg/Kg	30	90	3550/8270C
2,3,5,6-Tetrachlorophenol	U	U	µg/Kg	30	90	3550/8270C
Pyridine	U	U	µg/Kg	67	201	3550/8270C
FL-PRO (Petroleum Residual Organic Totals) Soil Dilution Factor = 1						
TOTAL PRO (C8-C40)	10.9		mg/Kg	0.01	0.03	FL-PRO
TPHCWG TPH-CWG Speciation Method (Soils) Dilution Factor = 1						
C5-C7 Aromatics	U	U	µg/Kg	5.0	15.0	TPHCWG
C7-C8 Aromatics	U	U	µg/Kg	5.0	15.0	TPHCWG
C8-C10 Aromatics	U	U	µg/Kg	5.0	15.0	TPHCWG
C10-C12 Aromatics	U	U	µg/Kg	5.0	15.0	TPHCWG
C12-C16 Aromatics	12.5	U	µg/Kg	5.0	15.0	TPHCWG
C16-C21 Aromatics	37.7	U	µg/Kg	5.0	15.0	TPHCWG
C21-C35 Aromatics	9.92	U	µg/Kg	5.0	15.0	TPHCWG
C5-C6 Aliphatics	U	U	µg/Kg	5.0	15.0	TPHCWG
C6-C8 Aliphatics	U	U	µg/Kg	5.0	15.0	TPHCWG
C8-C10 Aliphatics	U	U	µg/Kg	5.0	15.0	TPHCWG
C10-C12 Aliphatics	U	U	µg/Kg	5.0	15.0	TPHCWG
C12-C16 Aliphatics	U	U	µg/Kg	5.0	15.0	TPHCWG
C16-C35 Aliphatics	10800	U	µg/Kg	5.0	15.0	TPHCWG

QC=Qualifier Code as defined by DEP 62-160; U=Undetected; MDL=Minimum Detection Limit; PQL=Practical Quantation Limit.

BLIND PASS SEDIMENT CORE BP-1 (239-244 cm)

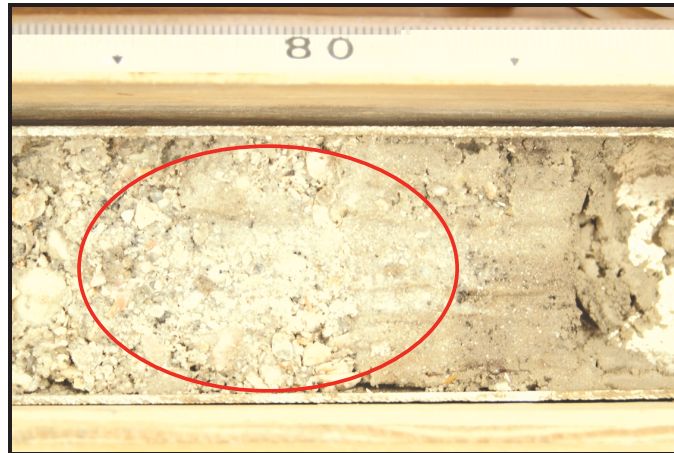

Red circle indicates area sampled for GC/MS analysis.

C₈-C₄₀ Table						
PARAMETER	RESULT	QC	UNITS	MDL	PQL	METHOD
Percent Solids	83.6		%	0.1	0.3	EPA 160.3
FL-PRO (Petroleum Residual Organic Totals) Soil Dilution Factor = 1						
TOTAL PRO (C8-C40)	1.76	U	mg/Kg	0.01	0.03	FL-PRO

QC=Qualifier Code as defined by DEP 62-160; U=Undetected; I=In between the MDL and PQL; Q= Out of hold; MDL=Minimum Detection Limit; PQL=Practical Quantation Limit.

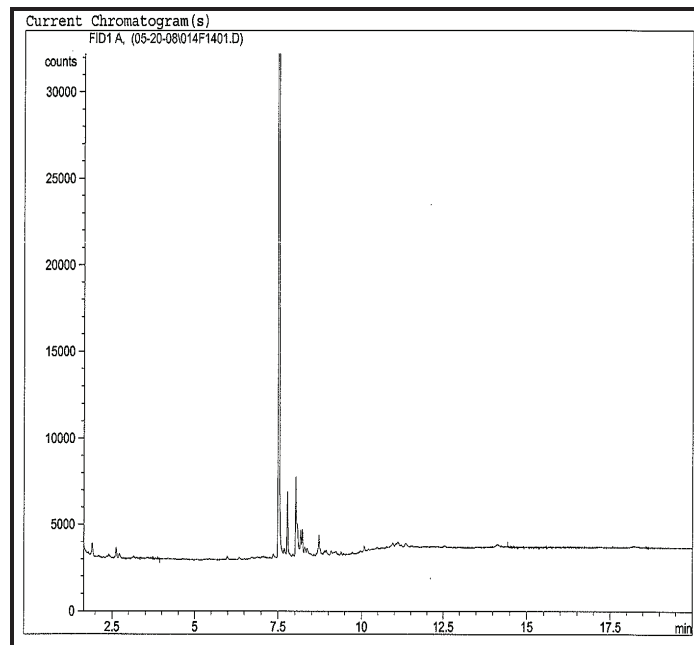

Chromatogram of sediment core BP-1 (239-244 cm).

Petroleum Hydrocarbon Speciation Analysis						
PARAMETER	RESULT	QC	UNITS	MDL	PQL	METHOD
Percent Solids	83.6		%	0.1	0.3	EPA 160.3
8260B VOA Compounds in Solids & Wastes GC/MS Dilution Factor = 1						
Methyl-tert-butyl-ether	U	U	µg/Kg	1.9	5.7	5030/8260B
Benzene	U	U	µg/Kg	0.85	2.55	5030/8260B
Toluene	U	U	µg/Kg	1.4	4.2	5030/8260B
Chlorobenzene	U	U	µg/Kg	2.3	6.9	5030/8260B
Ethylbenzene	U	U	µg/Kg	1.5	4.5	5030/8260B
M & p Xylene	U	U	µg/Kg	1.3	3.9	5030/8260B
o-Xylene	U	U	µg/Kg	1.1	3.3	5030/8260B
1,3-Dichlorobenzene	U	U	µg/Kg	3.2	9.6	5030/8260B
1,4-Dichlorobenzene	U	U	µg/Kg	2.0	6.0	5030/8260B
1,2-Dichlorobenzene	U	U	µg/Kg	3.5	10.5	5030/8260B
8270C Semivolatile Organics in Solids by GC/MS Dilution Factor = 1						
N-Nitrosodimethylamine	U	U	µg/Kg	69	207	3550/8270C
Phenol	U	U	µg/Kg	43	129	3550/8270C
2-Methyl Phenol (o-cresol)	U	U	µg/Kg	62	186	3550/8270C
3-Methyl Phenol (m-cresol)	U	U	µg/Kg	46	138	3550/8270C
4-Methyl Phenol (p-cresol)	U	U	µg/Kg	37	111	3550/8270C
Bis (2-Chloroethyl) Ether	U	U	µg/Kg	47	141	3550/8270C
2-Chlorophenol	U	U	µg/Kg	27.0	81.0	3550/8270C
1,3-Dichlorobenzene	U	U	µg/Kg	3.2	9.6	3550/8270C
1,4-Dichlorobenzene	U	U	µg/Kg	2.0	6.0	3550/8270C
Benzyl Alcohol	U	U	µg/Kg	3	9	3550/8270C
1,2-Dichlorobenzene	U	U	µg/Kg	3.5	10.5	3550/8270C
Bis (2-Chloroisopropyl) Ether	U	U	µg/Kg	47	141	3550/8270C
N-Nitrosodi-N-Proplamine	U	U	µg/Kg	24.0	72.0	3550/8270C
Hexachloroethane	U	U	µg/Kg	67	201	3550/8270C
Nitrobenzene	U	U	µg/Kg	38	114	3550/8270C
Isophorone	U	U	µg/Kg	76	228	3550/8270C
2-Nitrophenol	U	U	µg/Kg	78	234	3550/8270C
2,4-Dimethylphenol	U	U	µg/Kg	72	216	3550/8270C
Bis (2-Chloroethoxy)methane	U	U	µg/Kg	81	243	3550/8270C
2,4-Dichlorophenol	U	U	µg/Kg	59	177	3550/8270C
1,2,3-Trichlorobenzene	U	U	µg/Kg	32	96	3550/8270C
1,2,4-Trichlorobenzene	U	U	µg/Kg	42	126	3550/8270C
Naphthalene	U	U	µg/Kg	1	3	3550/8270C
Hexachlorobutadiene	U	U	µg/Kg	14	42	3550/8270C
4-Chloro-3-Methylphenol	U	U	µg/Kg	66	198	3550/8270C
1-Methylnaphthalene	U	U	µg/Kg	1	3	3550/8270C
2-Methylnaphthlene	U	U	µg/Kg	1	3	3550/8270C
Hexachlorocyclopentadiene	U	U	µg/Kg	41	123	3550/8270C
2,3,6-Trichlorophenol	U	U	µg/Kg	98	294	3550/8270C
2,4,5-Trichlorophenol	U	U	µg/Kg	60	180	3550/8270C
2,4,6-Trichlorophenol	U	U	µg/Kg	53	159	3550/8270C
2-Chloronaphthalene	U	U	µg/Kg	34	102	3550/8270C
Dimethyl Phthalate	U	U	µg/Kg	38	114	3550/8270C
Acenaphthylene	U	U	µg/Kg	2.0	6.0	3550/8270C
2,6-Dinitrotoluene	U	U	µg/Kg	26	78	3550/8270C
Acenaphthene	U	U	µg/Kg	1.3	3.9	3550/8270C
2,4-Dinitrophenol	U	U	µg/Kg	34	102	3550/8270C

Petroleum Hydrocarbon Speciation Analysis (continued)						
PARAMETER	RESULT	QC	UNITS	MDL	PQL	METHOD
2,4-Dinitrotoluene	U	U	µg/Kg	41	123	3550/8270C
4-Nitrophenol	U	U	µg/Kg	37	111	3550/8270C
Diethyl Phthalate	U	U	µg/Kg	35	105	3550/8270C
Fluorene	U	U	µg/Kg	1.0	3.0	3550/8270C
4-Chlorophenyl Phenyl Ether	U	U	µg/Kg	45	135	3550/8270C
4,6-Dinitro-2-Methylphenol	U	U	µg/Kg	36	108	3550/8270C
N-Nitrosodiphenylamine	U	U	µg/Kg	51	153	3550/8270C
4-Bromophenyl Phenyl Ether	U	U	µg/Kg	38	114	3550/8270C
Hexachlorobenzene	U	U	µg/Kg	36	108	3550/8270C
Pentachlorophenol	U	U	µg/Kg	1.7	5.1	3550/8270C
Phenanthrene	U	U	µg/Kg	2	6	3550/8270C
Anthracene	U	U	µg/Kg	0.6	1.8	3550/8270C
Di-N-Butyl Phthalate	U	U	µg/Kg	34	102	3550/8270C
Fluoranthene	U	U	µg/Kg	1.6	4.8	3550/8270C
Benzidine	U	U	µg/Kg	33	99	3550/8270C
Pyrene	U	U	µg/Kg	2	6	3550/8270C
Butyl Benzyl Phthalate	U	U	µg/Kg	50	150	3550/8270C
Benzo(A)Anthracene	U	U	µg/Kg	1	3	3550/8270C
3,3-Dichlorobenzidine	U	U	µg/Kg	100	300	3550/8270C
Chrysene	U	U	µg/Kg	1	3	3550/8270C
Bis (2 Ethylhexyl) Phthalate	U	U	µg/Kg	39	117	3550/8270C
Di-N-Octyl Phthalate	U	U	µg/Kg	44	132	3550/8270C
Benzo(B)Fluoranthene	U	U	µg/Kg	1	3	3550/8270C
Benzo(K)Fluoranthene	U	U	µg/Kg	1	3	3550/8270C
Benzo(A)Pyrene	U	U	µg/Kg	1	3	3550/8270C
Indeno(1,2,3-CD)Pyrene	U	U	µg/Kg	2	6	3550/8270C
Dibenzo (A,H) Anthracene	U	U	µg/Kg	2	6	3550/8270C
Benzo(G,H,I)Perylene	U	U	µg/Kg	2	6	3550/8270C
Bis-2-ethylexyl Adipate	U	U	µg/Kg	33	99	3550/8270C
Aldrin	U	U	µg/Kg	1.0	3.0	3550/8270C
-BHC	U	U	µg/Kg	3.0	9.0	3550/8270C
-BHC	U	U	µg/Kg	3.0	9.0	3550/8270C
-BHC	U	U	µg/Kg	3.0	9.0	3550/8270C
-BHC (Lindane)	U	U	µg/Kg	1.0	3.0	3550/8270C
Clordane	U	U	µg/Kg	1.0	3.0	3550/8270C
4,4'-DDD	U	U	µg/Kg	2	6	3550/8270C
4,4'-DDE	U	U	µg/Kg	1.39	4017	3550/8270C
4,4'-DDT	U	U	µg/Kg	1.69	5.07	3550/8270C
Dieldrin	U	U	µg/Kg	0.840	2.520	3550/8270C
Endosulfan I	U	U	µg/Kg	1.100	3.300	3550/8270C
Endosulfan II	U	U	µg/Kg	1.60	4.80	3550/8270C
Endosulfan Sulfate	U	U	µg/Kg	1.70	5.10	3550/8270C
Endrin	U	U	µg/Kg	1.800	5.400	3550/8270C
Endrin Aldehyde	U	U	µg/Kg	1.900	5.700	3550/8270C
Heptachlor	U	U	µg/Kg	1.78	5.34	3550/8270C
Heptachlor Epoxide	U	U	µg/Kg	1.68	5.04	3550/8270C
Toxaphene	U	U	µg/Kg	1.90	5.70	3550/8270C
PCB-1016	U	U	µg/Kg	0.30	0.90	3550/8270C
PCB-1221	U	U	µg/Kg	0.30	0.90	3550/8270C
PCB-1232	U	U	µg/Kg	0.30	0.90	3550/8270C
PCB-1242	U	U	µg/Kg	0.30	0.90	3550/8270C

Petroleum Hydrocarbon Speciation Analysis (continued)						
PARAMETER	RESULT	QC	UNITS	MDL	PQL	METHOD
PCB-1248	U	U	µg/Kg	0.30	0.90	3550/8270C
PCB-1254	U	U	µg/Kg	0.30	0.90	3550/8270C
PCB-1260	U	U	µg/Kg	0.30	0.90	3550/8270C
Dioxin	U	U	µg/Kg	30	90	3550/8270C
Azobenzene	U	U	µg/Kg	30	90	3550/8270C
Methoxychlor	U	U	µg/Kg	19	57	3550/8270C
Benzoic Acid	U	U	µg/Kg	30	90	3550/8270C
Aniline	U	U	µg/Kg	30	90	3550/8270C
4-Chloroaniline	U	U	µg/Kg	11	33	3550/8270C
Dibenzofuran	U	U	µg/Kg	30	90	3550/8270C
2-Nitroaniline	U	U	µg/Kg	37	111	3550/8270C
30Nitroaniline	U	U	µg/Kg	30	90	3550/8270C
4-Nitroaniline	U	U	µg/Kg	30	90	3550/8270C
Carbazole	U	U	µg/Kg	30	90	3550/8270C
2,6-Dichlorophenol	U	U	µg/Kg	17	51	3550/8270C
2,3,4,6-Tetrachlorophenol	U	U	µg/Kg	30	90	3550/8270C
2,3,5,6-Tetrachlorophenol	U	U	µg/Kg	30	90	3550/8270C
Pyridine	U	U	µg/Kg	67	201	3550/8270C
FL-PRO (Petroleum Residual Organic Totals) Soil Dilution Factor = 1						
TOTAL PRO (C8-C40)	1.76		mg/Kg	0.01	0.03	FL-PRO
TPHCWG TPH-CWG Speciation Method (Soils) Dilution Factor = 1						
C5-C7 Aromatics	U	U	µg/Kg	5.0	15.0	TPHCWG
C7-C8 Aromatics	U	U	µg/Kg	5.0	15.0	TPHCWG
C8-C10 Aromatics	U	U	µg/Kg	5.0	15.0	TPHCWG
C10-C12 Aromatics	U	U	µg/Kg	5.0	15.0	TPHCWG
C12-C16 Aromatics	U	U	µg/Kg	5.0	15.0	TPHCWG
C16-C21 Aromatics	U	U	µg/Kg	5.0	15.0	TPHCWG
C21-C35 Aromatics	U	U	µg/Kg	5.0	15.0	TPHCWG
C5-C6 Aliphatics	U	U	µg/Kg	5.0	15.0	TPHCWG
C6-C8 Aliphatics	U	U	µg/Kg	5.0	15.0	TPHCWG
C8-C10 Aliphatics	U	U	µg/Kg	5.0	15.0	TPHCWG
C10-C12 Aliphatics	U	U	µg/Kg	5.0	15.0	TPHCWG
C12-C16 Aliphatics	U	U	µg/Kg	5.0	15.0	TPHCWG
C16-C35 Aliphatics	1760	I	µg/Kg	5.0	15.0	TPHCWG

QC=Qualifier Code as defined by DEP 62-160; U=Undetected; MDL=Minimum Detection Limit; PQL=Practical Quantization Limit.

BLIND PASS SEDIMENT CORE BP-1 (249-254 cm)



Red circle indicates area sampled for GC/MS.

C₈-C₄₀ Table						
PARAMETER	RESULT	QC	UNITS	MDL	PQL	METHOD
Percent Solids	67.0		%	0.1	0.3	EPA 160.3
FL-PRO (Petroleum Residual Organic Totals) Soil Dilution Factor = 1						
TOTAL PRO (C8-C40)	55.9		mg/Kg	0.01	0.03	FL-PRO

QC=Qualifier Code as defined by DEP 62-160; U=Undetected; I=In between the MDL and PQL; Q= Out of hold; MDL=Minimum Detection Limit; PQL=Practical Quantation Limit.

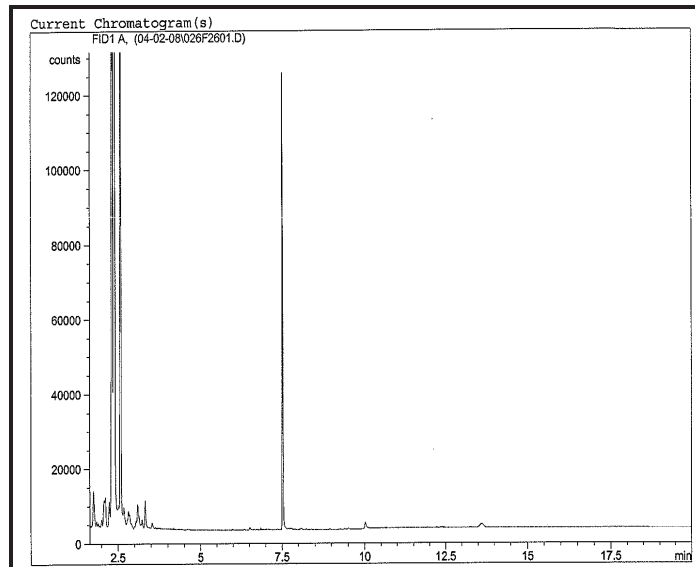

Chromatogram for sediment core BP-1 (249-254 cm).

Petroleum Hydrocarbon Speciation Analysis						
PARAMETER	RESULT	QC	UNITS	MDL	PQL	METHOD

Petroleum Hydrocarbon Speciation Analysis (continued)						
PARAMETER	RESULT	QC	UNITS	MDL	PQL	METHOD
2,4-Dinitrotoluene	U	U	µg/Kg	41	123	3550/8270C
4-Nitrophenol	U	U	µg/Kg	37	111	3550/8270C
Diethyl Phthalate	U	U	µg/Kg	35	105	3550/8270C
Fluorene	U	U	µg/Kg	1.0	3.0	3550/8270C
4-Chlorophenyl Phenyl Ether	U	U	µg/Kg	45	135	3550/8270C
4,6-Dinitro-2-Methylphenol	U	U	µg/Kg	36	108	3550/8270C
N-Nitrosodiphenylamine	U	U	µg/Kg	51	153	3550/8270C
4-Bromophenyl Phenyl Ether	U	U	µg/Kg	38	114	3550/8270C
Hexachlorobenzene	U	U	µg/Kg	36	108	3550/8270C
Pentachlorophenol	U	U	µg/Kg	1.7	5.1	3550/8270C
Phenanthrene	U	U	µg/Kg	2	6	3550/8270C
Anthracene	U	U	µg/Kg	0.6	1.8	3550/8270C
Di-N-Butyl Phthalate	U	U	µg/Kg	34	102	3550/8270C
Fluoranthene	U	U	µg/Kg	1.6	4.8	3550/8270C
Benzidine	U	U	µg/Kg	33	99	3550/8270C
Pyrene	U	U	µg/Kg	2	6	3550/8270C
Butyl Benzyl Phthalate	U	U	µg/Kg	50	150	3550/8270C
Benzo(A)Anthracene	U	U	µg/Kg	1	3	3550/8270C
3,3-Dichlorobenzidine	U	U	µg/Kg	100	300	3550/8270C
Chrysene	U	U	µg/Kg	1	3	3550/8270C
Bis (2 Ethylhexyl) Phthalate	U	U	µg/Kg	39	117	3550/8270C
Di-N-Octyl Phthalate	U	U	µg/Kg	44	132	3550/8270C
Benzo(B)Fluoranthene	U	U	µg/Kg	1	3	3550/8270C
Benzo(K)Fluoranthene	U	U	µg/Kg	1	3	3550/8270C
Benzo(A)Pyrene	U	U	µg/Kg	1	3	3550/8270C
Indeno(1,2,3-CD)Pyrene	U	U	µg/Kg	2	6	3550/8270C
Dibenzo (A,H) Anthracene	U	U	µg/Kg	2	6	3550/8270C
Benzo(G,H,I)Perylene	U	U	µg/Kg	2	6	3550/8270C
Bis-2-ethylexyl Adipate	U	U	µg/Kg	33	99	3550/8270C
Aldrin	U	U	µg/Kg	1.0	3.0	3550/8270C
-BHC	U	U	µg/Kg	3.0	9.0	3550/8270C
-BHC	U	U	µg/Kg	3.0	9.0	3550/8270C
-BHC	U	U	µg/Kg	3.0	9.0	3550/8270C
-BHC (Lindane)	U	U	µg/Kg	1.0	3.0	3550/8270C
Clordane	U	U	µg/Kg	1.0	3.0	3550/8270C
4,4'-DDD	U	U	µg/Kg	2	6	3550/8270C
4,4'-DDE	U	U	µg/Kg	1.39	4017	3550/8270C
4,4'-DDT	U	U	µg/Kg	1.69	5.07	3550/8270C
Dieldrin	U	U	µg/Kg	0.840	2.520	3550/8270C
Endosulfan I	U	U	µg/Kg	1.100	3.300	3550/8270C
Endosulfan II	U	U	µg/Kg	1.60	4.80	3550/8270C
Endosulfan Sulfate	U	U	µg/Kg	1.70	5.10	3550/8270C
Endrin	U	U	µg/Kg	1.800	5.400	3550/8270C
Endrin Aldehyde	U	U	µg/Kg	1.900	5.700	3550/8270C
Heptachlor	U	U	µg/Kg	1.78	5.34	3550/8270C
Heptachlor Epoxide	U	U	µg/Kg	1.68	5.04	3550/8270C
Toxaphene	U	U	µg/Kg	1.90	5.70	3550/8270C
PCB-1016	U	U	µg/Kg	0.30	0.90	3550/8270C
PCB-1221	U	U	µg/Kg	0.30	0.90	3550/8270C
PCB-1232	U	U	µg/Kg	0.30	0.90	3550/8270C
PCB-1242	U	U	µg/Kg	0.30	0.90	3550/8270C

Petroleum Hydrocarbon Speciation Analysis (continued)						
PARAMETER	RESULT	QC	UNITS	MDL	PQL	METHOD
PCB-1248	U	U	µg/Kg	0.30	0.90	3550/8270C
PCB-1254	U	U	µg/Kg	0.30	0.90	3550/8270C
PCB-1260	U	U	µg/Kg	0.30	0.90	3550/8270C
Dioxin	U	U	µg/Kg	30	90	3550/8270C
Azobenzene	U	U	µg/Kg	30	90	3550/8270C
Methoxychlor	U	U	µg/Kg	19	57	3550/8270C
Benzoic Acid	U	U	µg/Kg	30	90	3550/8270C
Aniline	U	U	µg/Kg	30	90	3550/8270C
4-Chloroaniline	U	U	µg/Kg	11	33	3550/8270C
Dibenzofuran	U	U	µg/Kg	30	90	3550/8270C
2-Nitroaniline	U	U	µg/Kg	37	111	3550/8270C
30Nitroaniline	U	U	µg/Kg	30	90	3550/8270C
4-Nitroaniline	U	U	µg/Kg	30	90	3550/8270C
Carbazole	U	U	µg/Kg	30	90	3550/8270C
2,6-Dichlorophenol	U	U	µg/Kg	17	51	3550/8270C
2,3,4,6-Tetrachlorophenol	U	U	µg/Kg	30	90	3550/8270C
2,3,5,6-Tetrachlorophenol	U	U	µg/Kg	30	90	3550/8270C
Pyridine	U	U	µg/Kg	67	201	3550/8270C
FL-PRO (Petroleum Residual Organic Totals) Soil Dilution Factor = 1						
TOTAL PRO (C8-C40)	55.9		mg/Kg	0.01	0.03	FL-PRO
TPHCWG TPH-CWG Speciation Method (Soils) Dilution Factor = 1						
C5-C7 Aromatics	U	U	µg/Kg	5.0	15.0	TPHCWG
C7-C8 Aromatics	U	U	µg/Kg	5.0	15.0	TPHCWG
C8-C10 Aromatics	U	U	µg/Kg	5.0	15.0	TPHCWG
C10-C12 Aromatics	U	U	µg/Kg	5.0	15.0	TPHCWG
C12-C16 Aromatics	U	U	µg/Kg	5.0	15.0	TPHCWG
C16-C21 Aromatics	U	U	µg/Kg	5.0	15.0	TPHCWG
C21-C35 Aromatics	U	U	µg/Kg	5.0	15.0	TPHCWG
C5-C6 Aliphatics	U	U	µg/Kg	5.0	15.0	TPHCWG
C6-C8 Aliphatics	U	U	µg/Kg	5.0	15.0	TPHCWG
C8-C10 Aliphatics	99.2		µg/Kg	5.0	15.0	TPHCWG
C10-C12 Aliphatics	U	U	µg/Kg	5.0	15.0	TPHCWG
C12-C16 Aliphatics	U	U	µg/Kg	5.0	15.0	TPHCWG
C16-C35 Aliphatics	U	U	µg/Kg	5.0	15.0	TPHCWG

QC=Qualifier Code as defined by DEP 62-160; U=Undetected; MDL=Minimum Detection Limit; PQL=Practical Quantization Limit.

BLIND PASS SEDIMENT CORE BP-40 (109-119 cm)

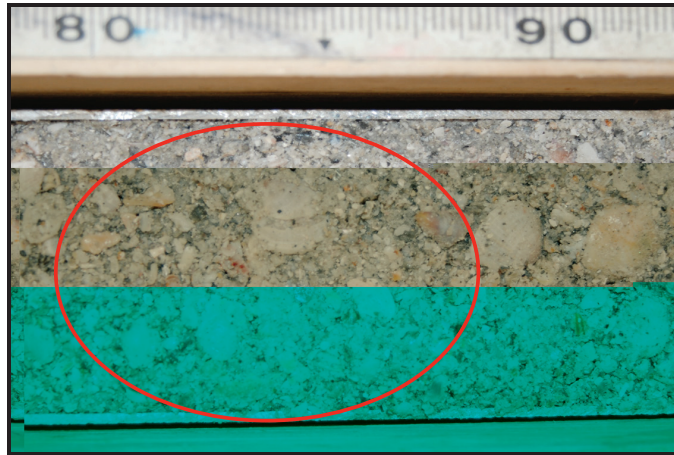

Red circle indicates area sampled for GC/MS analysis.

C₈-C₄₀ Table						
PARAMETER	RESULT	QC	UNITS	MDL	PQL	METHOD
Percent Solids	90.0		%	0.1	0.3	EPA 160.3
FL-PRO (Petroleum Residual Organic Totals) Soil Dilution Factor = 1						
TOTAL PRO (C8-C40)	4.13	U	mg/Kg	0.01	0.03	FL-PRO

QC=Qualifier Code as defined by DEP 62-160; U=Undetected; I=In between the MDL and PQL; Q= Out of hold; MDL=Minimum Detection Limit; PQL=Practical Quantation Limit.

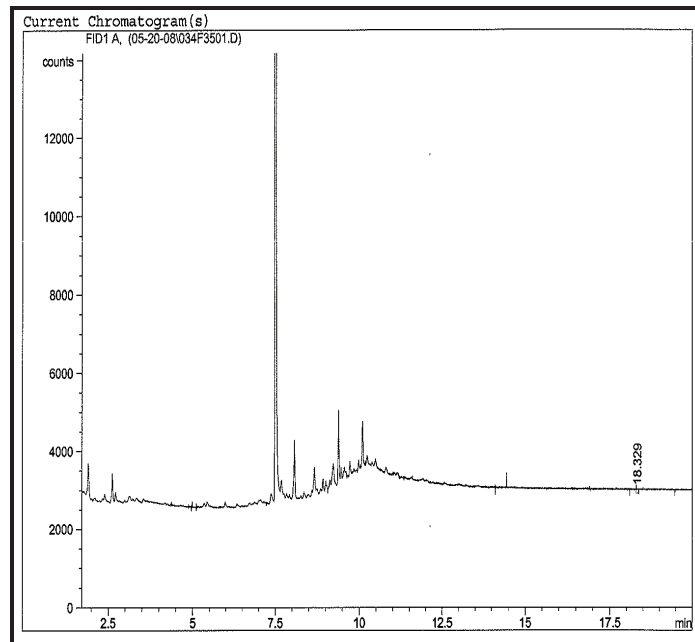

Chromatogram for sediment core BP-40 (109-119 cm).

Petroleum Hydrocarbon Speciation Analysis						
PARAMETER	RESULT	QC	UNITS	MDL	PQL	METHOD
Percent Solids	90.0		%	0.1	0.3	EPA 160.3
8260B VOA Compounds in Solids & Wastes GC/MS Dilution Factor = 1						
Methyl-tert-butyl-ether	U	U	µg/Kg	1.9	5.7	5030/8260B
Benzene	U	U	µg/Kg	0.85	2.55	5030/8260B
Toluene	U	U	µg/Kg	1.4	4.2	5030/8260B
Chlorobenzene	U	U	µg/Kg	2.3	6.9	5030/8260B
Ethylbenzene	U	U	µg/Kg	1.5	4.5	5030/8260B
M & p Xylene	U	U	µg/Kg	1.3	3.9	5030/8260B
o-Xylene	U	U	µg/Kg	1.1	3.3	5030/8260B
1,3-Dichlorobenzene	U	U	µg/Kg	3.2	9.6	5030/8260B
1,4-Dichlorobenzene	U	U	µg/Kg	2.0	6.0	5030/8260B
1,2-Dichlorobenzene	U	U	µg/Kg	3.5	10.5	5030/8260B
8270C Semivolatile Organics in Solids by GC/MS Dilution Factor = 1						
N-Nitrosodimethylamine	U	U	µg/Kg	69	207	3550/8270C
Phenol	U	U	µg/Kg	43	129	3550/8270C
2-Methyl Phenol (o-cresol)	U	U	µg/Kg	62	186	3550/8270C
3-Methyl Phenol (m-cresol)	U	U	µg/Kg	46	138	3550/8270C
4-Methyl Phenol (p-cresol)	U	U	µg/Kg	37	111	3550/8270C
Bis (2-Chloroethyl) Ether	U	U	µg/Kg	47	141	3550/8270C
2-Chlorophenol	U	U	µg/Kg	27.0	81.0	3550/8270C
1,3-Dichlorobenzene	U	U	µg/Kg	3.2	9.6	3550/8270C
1,4-Dichlorobenzene	U	U	µg/Kg	2.0	6.0	3550/8270C
Benzyl Alcohol	U	U	µg/Kg	3	9	3550/8270C
1,2-Dichlorobenzene	U	U	µg/Kg	3.5	10.5	3550/8270C
Bis (2-Chloroisopropyl) Ether	U	U	µg/Kg	47	141	3550/8270C
N-Nitrosodi-N-Proplamine	U	U	µg/Kg	24.0	72.0	3550/8270C
Hexachloroethane	U	U	µg/Kg	67	201	3550/8270C
Nitrobenzene	U	U	µg/Kg	38	114	3550/8270C
Isophorone	U	U	µg/Kg	76	228	3550/8270C
2-Nitrophenol	U	U	µg/Kg	78	234	3550/8270C
2,4-Dimethylphenol	U	U	µg/Kg	72	216	3550/8270C
Bis (2-Chloroethoxy)methane	U	U	µg/Kg	81	243	3550/8270C
2,4-Dichlorophenol	U	U	µg/Kg	59	177	3550/8270C
1,2,3-Trichlorobenzene	U	U	µg/Kg	32	96	3550/8270C
1,2,4-Trichlorobenzene	U	U	µg/Kg	42	126	3550/8270C
Naphthalene	U	U	µg/Kg	1	3	3550/8270C
Hexachlorobutadiene	U	U	µg/Kg	14	42	3550/8270C
4-Chloro-3-Methylphenol	U	U	µg/Kg	66	198	3550/8270C
1-Methylnaphthalene	U	U	µg/Kg	1	3	3550/8270C
2-Methylnaphthlene	U	U	µg/Kg	1	3	3550/8270C
Hexachlorocyclopentadiene	U	U	µg/Kg	41	123	3550/8270C
2,3,6-Trichlorophenol	U	U	µg/Kg	98	294	3550/8270C
2,4,5-Trichlorophenol	U	U	µg/Kg	60	180	3550/8270C
2,4,6-Trichlorophenol	U	U	µg/Kg	53	159	3550/8270C
2-Chloronaphthalene	U	U	µg/Kg	34	102	3550/8270C
Dimethyl Phthalate	U	U	µg/Kg	38	114	3550/8270C
Acenaphthylene	U	U	µg/Kg	2.0	6.0	3550/8270C
2,6-Dinitrotoluene	U	U	µg/Kg	26	78	3550/8270C
Acenaphthene	U	U	µg/Kg	1.3	3.9	3550/8270C
2,4-Dinitrophenol	U	U	µg/Kg	34	102	3550/8270C

Petroleum Hydrocarbon Speciation Analysis (continued)						
PARAMETER	RESULT	QC	UNITS	MDL	PQL	METHOD
2,4-Dinitrotoluene	U	U	µg/Kg	41	123	3550/8270C
4-Nitrophenol	U	U	µg/Kg	37	111	3550/8270C
Diethyl Phthalate	U	U	µg/Kg	35	105	3550/8270C
Fluorene	U	U	µg/Kg	1.0	3.0	3550/8270C
4-Chlorophenyl Phenyl Ether	U	U	µg/Kg	45	135	3550/8270C
4,6-Dinitro-2-Methylphenol	U	U	µg/Kg	36	108	3550/8270C
N-Nitrosodiphenylamine	U	U	µg/Kg	51	153	3550/8270C
4-Bromophenyl Phenyl Ether	U	U	µg/Kg	38	114	3550/8270C
Hexachlorobenzene	U	U	µg/Kg	36	108	3550/8270C
Pentachlorophenol	U	U	µg/Kg	1.7	5.1	3550/8270C
Phenanthrene	U	U	µg/Kg	2	6	3550/8270C
Anthracene	U	U	µg/Kg	0.6	1.8	3550/8270C
Di-N-Butyl Phthalate	U	U	µg/Kg	34	102	3550/8270C
Fluoranthene	U	U	µg/Kg	1.6	4.8	3550/8270C
Benzidine	U	U	µg/Kg	33	99	3550/8270C
Pyrene	U	U	µg/Kg	2	6	3550/8270C
Butyl Benzyl Phthalate	U	U	µg/Kg	50	150	3550/8270C
Benzo(A)Anthracene	U	U	µg/Kg	1	3	3550/8270C
3,3-Dichlorobenzidine	U	U	µg/Kg	100	300	3550/8270C
Chrysene	U	U	µg/Kg	1	3	3550/8270C
Bis (2 Ethylhexyl) Phthalate	U	U	µg/Kg	39	117	3550/8270C
Di-N-Octyl Phthalate	U	U	µg/Kg	44	132	3550/8270C
Benzo(B)Fluoranthene	U	U	µg/Kg	1	3	3550/8270C
Benzo(K)Fluoranthene	U	U	µg/Kg	1	3	3550/8270C
Benzo(A)Pyrene	U	U	µg/Kg	1	3	3550/8270C
Indeno(1,2,3-CD)Pyrene	U	U	µg/Kg	2	6	3550/8270C
Dibenzo (A,H) Anthracene	U	U	µg/Kg	2	6	3550/8270C
Benzo(G,H,I)Perylene	U	U	µg/Kg	2	6	3550/8270C
Bis-2-ethylexyl Adipate	U	U	µg/Kg	33	99	3550/8270C
Aldrin	U	U	µg/Kg	1.0	3.0	3550/8270C
-BHC	U	U	µg/Kg	3.0	9.0	3550/8270C
-BHC	U	U	µg/Kg	3.0	9.0	3550/8270C
-BHC	U	U	µg/Kg	3.0	9.0	3550/8270C
-BHC (Lindane)	U	U	µg/Kg	1.0	3.0	3550/8270C
Clordane	U	U	µg/Kg	1.0	3.0	3550/8270C
4,4'-DDD	U	U	µg/Kg	2	6	3550/8270C
4,4'-DDE	U	U	µg/Kg	1.39	4017	3550/8270C
4,4'-DDT	U	U	µg/Kg	1.69	5.07	3550/8270C
Dieldrin	U	U	µg/Kg	0.840	2.520	3550/8270C
Endosulfan I	U	U	µg/Kg	1.100	3.300	3550/8270C
Endosulfan II	U	U	µg/Kg	1.60	4.80	3550/8270C
Endosulfan Sulfate	U	U	µg/Kg	1.70	5.10	3550/8270C
Endrin	U	U	µg/Kg	1.800	5.400	3550/8270C
Endrin Aldehyde	U	U	µg/Kg	1.900	5.700	3550/8270C
Heptachlor	U	U	µg/Kg	1.78	5.34	3550/8270C
Heptachlor Epoxide	U	U	µg/Kg	1.68	5.04	3550/8270C
Toxaphene	U	U	µg/Kg	1.90	5.70	3550/8270C
PCB-1016	U	U	µg/Kg	0.30	0.90	3550/8270C
PCB-1221	U	U	µg/Kg	0.30	0.90	3550/8270C
PCB-1232	U	U	µg/Kg	0.30	0.90	3550/8270C
PCB-1242	U	U	µg/Kg	0.30	0.90	3550/8270C

Petroleum Hydrocarbon Speciation Analysis (continued)						
PARAMETER	RESULT	QC	UNITS	MDL	PQL	METHOD
PCB-1248	U	U	µg/Kg	0.30	0.90	3550/8270C
PCB-1254	U	U	µg/Kg	0.30	0.90	3550/8270C
PCB-1260	U	U	µg/Kg	0.30	0.90	3550/8270C
Dioxin	U	U	µg/Kg	30	90	3550/8270C
Azobenzene	U	U	µg/Kg	30	90	3550/8270C
Methoxychlor	U	U	µg/Kg	19	57	3550/8270C
Benzoic Acid	U	U	µg/Kg	30	90	3550/8270C
Aniline	U	U	µg/Kg	30	90	3550/8270C
4-Chloroaniline	U	U	µg/Kg	11	33	3550/8270C
Dibenzofuran	U	U	µg/Kg	30	90	3550/8270C
2-Nitroaniline	U	U	µg/Kg	37	111	3550/8270C
30Nitroaniline	U	U	µg/Kg	30	90	3550/8270C
4-Nitroaniline	U	U	µg/Kg	30	90	3550/8270C
Carbazole	U	U	µg/Kg	30	90	3550/8270C

BLIND PASS SEDIMENT CORE BP-39 (168-178 cm)

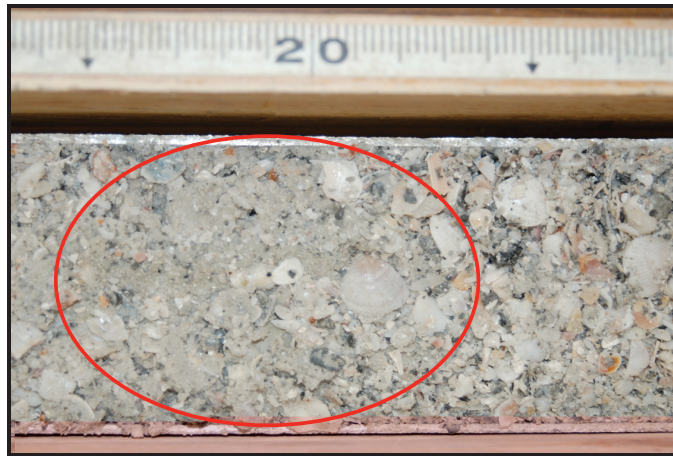

Red circle indicates area sampled for GC/MS analysis.

C₈-C₄₀ Table						
PARAMETER	RESULT	QC	UNITS	MDL	PQL	METHOD
Percent Solids	82.5		%	0.1	0.3	EPA 160.3
FL-PRO (Petroleum Residual Organic Totals) Soil Dilution Factor = 1						
TOTAL PRO (C8-C40)	4.11	U	mg/Kg	0.01	0.03	FL-PRO

QC=Qualifier Code as defined by DEP 62-160; U=Undetected; I=In between the MDL and PQL; Q= Out of hold; MDL=Minimum Detection Limit; PQL=Practical Quantation Limit.

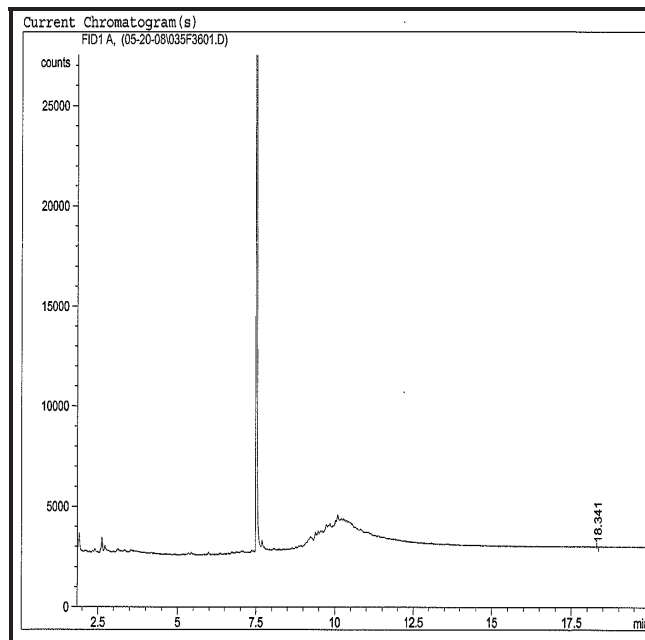

Chromatogram for sediment core BP-39 (168-178 cm).

Petroleum Hydrocarbon Speciation Analysis						
PARAMETER	RESULT	QC	UNITS	MDL	PQL	METHOD
Percent Solids	82.5		%	0.1	0.3	EPA 160.3
8260B VOA Compounds in Solids & Wastes GC/MS Dilution Factor = 1						
Methyl-tert-butyl-ether	U	U	µg/Kg	1.9	5.7	5030/8260B
Benzene	U	U	µg/Kg	0.85	2.55	5030/8260B
Toluene	U	U	µg/Kg	1.4	4.2	5030/8260B
Chlorobenzene	U	U	µg/Kg	2.3	6.9	5030/8260B
Ethylbenzene	U	U	µg/Kg	1.5	4.5	5030/8260B
M & p Xylene	U	U	µg/Kg	1.3	3.9	5030/8260B
o-Xylene	U	U	µg/Kg	1.1	3.3	5030/8260B
1,3-Dichlorobenzene	U	U	µg/Kg	3.2	9.6	5030/8260B
1,4-Dichlorobenzene	U	U	µg/Kg	2.0	6.0	5030/8260B
1,2-Dichlorobenzene	U	U	µg/Kg	3.5	10.5	5030/8260B
8270C Semivolatile Organics in Solids by GC/MS Dilution Factor = 1						
N-Nitrosodimethylamine	U	U	µg/Kg	69	207	3550/8270C
Phenol	U	U	µg/Kg	43	129	3550/8270C
2-Methyl Phenol (o-cresol)	U	U	µg/Kg	62	186	3550/8270C
3-Methyl Phenol (m-cresol)	U	U	µg/Kg	46	138	3550/8270C
4-Methyl Phenol (p-cresol)	U	U	µg/Kg	37	111	3550/8270C
Bis (2-Chloroethyl) Ether	U	U	µg/Kg	47	141	3550/8270C
2-Chlorophenol	U	U	µg/Kg	27.0	81.0	3550/8270C
1,3-Dichlorobenzene	U	U	µg/Kg	3.2	9.6	3550/8270C
1,4-Dichlorobenzene	U	U	µg/Kg	2.0	6.0	3550/8270C
Benzyl Alcohol	U	U	µg/Kg	3	9	3550/8270C
1,2-Dichlorobenzene	U	U	µg/Kg	3.5	10.5	3550/8270C
Bis (2-Chloroisopropyl) Ether	U	U	µg/Kg	47	141	3550/8270C
N-Nitrosodi-N-Propylamine	U	U	µg/Kg	24.0	72.0	3550/8270C
Hexachloroethane	U	U	µg/Kg	67	201	3550/8270C
Nitrobenzene	U	U	µg/Kg	38	114	3550/8270C
Isophorone	U	U	µg/Kg	76	228	3550/8270C
2-Nitrophenol	U	U	µg/Kg	78	234	3550/8270C
2,4-Dimethylphenol	U	U	µg/Kg	72	216	3550/8270C
Bis (2-Chloroethoxy)methane	U	U	µg/Kg	81	243	3550/8270C
2,4-Dichlorophenol	U	U	µg/Kg	59	177	3550/8270C
1,2,3-Trichlorobenzene	U	U	µg/Kg	32	96	3550/8270C
1,2,4-Trichlorobenzene	U	U	µg/Kg	42	126	3550/8270C
Naphthalene	U	U	µg/Kg	1	3	3550/8270C
Hexachlorobutadiene	U	U	µg/Kg	14	42	3550/8270C
4-Chloro-3-Methylphenol	U	U	µg/Kg	66	198	3550/8270C
1-Methylnaphthalene	U	U	µg/Kg	1	3	3550/8270C
2-Methylnaphthlene	U	U	µg/Kg	1	3	3550/8270C
Hexachlorocyclopentadiene	U	U	µg/Kg	41	123	3550/8270C
2,3,6-Trichlorophenol	U	U	µg/Kg	98	294	3550/8270C
2,4,5-Trichlorophenol	U	U	µg/Kg	60	180	3550/8270C
2,4,6-Trichlorophenol	U	U	µg/Kg	53	159	3550/8270C
2-Chloronaphthalene	U	U	µg/Kg	34	102	3550/8270C
Dimethyl Phthalate	U	U	µg/Kg	38	114	3550/8270C
Acenaphthylene	U	U	µg/Kg	2.0	6.0	3550/8270C
2,6-Dinitrotoluene	U	U	µg/Kg	26	78	3550/8270C
Acenaphthene	U	U	µg/Kg	1.3	3.9	3550/8270C
2,4-Dinitrophenol	U	U	µg/Kg	34	102	3550/8270C

Petroleum Hydrocarbon Speciation Analysis (continued)						
PARAMETER	RESULT	QC	UNITS	MDL	PQL	METHOD
2,4-Dinitrotoluene	U	U	µg/Kg	41	123	3550/8270C
4-Nitrophenol	U	U	µg/Kg	37	111	3550/8270C
Diethyl Phthalate	U	U	µg/Kg	35	105	3550/8270C
Fluorene	U	U	µg/Kg	1.0	3.0	3550/8270C
4-Chlorophenyl Phenyl Ether	U	U	µg/Kg	45	135	3550/8270C
4,6-Dinitro-2-Methylphenol	U	U	µg/Kg	36	108	3550/8270C
N-Nitrosodiphenylamine	U	U	µg/Kg	51	153	3550/8270C
4-Bromophenyl Phenyl Ether	U	U	µg/Kg	38	114	3550/8270C
Hexachlorobenzene	U	U	µg/Kg	36	108	3550/8270C
Pentachlorophenol	U	U	µg/Kg	1.7	5.1	3550/8270C
Phenanthrene	U	U	µg/Kg	2	6	3550/8270C
Anthracene	U	U	µg/Kg	0.6	1.8	3550/8270C
Di-N-Butyl Phthalate	U	U	µg/Kg	34	102	3550/8270C
Fluoranthene	U	U	µg/Kg	1.6	4.8	3550/8270C
Benzidine	U	U	µg/Kg	33	99	3550/8270C
Pyrene	U	U	µg/Kg	2	6	3550/8270C
Butyl Benzyl Phthalate	U	U	µg/Kg	50	150	3550/8270C
Benzo(A)Anthracene	U	U	µg/Kg	1	3	3550/8270C
3,3-Dichlorobenzidine	U	U	µg/Kg	100	300	3550/8270C
Chrysene	U	U	µg/Kg	1	3	3550/8270C
Bis (2 Ethylhexyl) Phthalate	U	U	µg/Kg	39	117	3550/8270C
Di-N-Octyl Phthalate	U	U	µg/Kg	44	132	3550/8270C
Benzo(B)Fluoranthene	U	U	µg/Kg	1	3	3550/8270C
Benzo(K)Fluoranthene	U	U	µg/Kg	1	3	3550/8270C
Benzo(A)Pyrene	U	U	µg/Kg	1	3	3550/8270C
Indeno(1,2,3-CD)Pyrene	U	U	µg/Kg	2	6	3550/8270C
Dibenzo (A,H) Anthracene	U	U	µg/Kg	2	6	3550/8270C
Benzo(G,H,I)Perylene	U	U	µg/Kg	2	6	3550/8270C
Bis-2-ethylhexyl Adipate	U	U	µg/Kg	33	99	3550/8270C
Aldrin	U	U	µg/Kg	1.0	3.0	3550/8270C
-BHC	U	U	µg/Kg	3.0	9.0	3550/8270C
-BHC	U	U	µg/Kg	3.0	9.0	3550/8270C
-BHC	U	U	µg/Kg	3.0	9.0	3550/8270C
-BHC (Lindane)	U	U	µg/Kg	1.0	3.0	3550/8270C
Clordane	U	U	µg/Kg	1.0	3.0	3550/8270C
4,4'-DDD	U	U	µg/Kg	2	6	3550/8270C
4,4'-DDE	U	U	µg/Kg	1.39	4017	3550/8270C
4,4'-DDT	U	U	µg/Kg	1.69	5.07	3550/8270C

Petroleum Hydrocarbon Speciation Analysis (continued)						
PARAMETER	RESULT	QC	UNITS	MDL	PQL	METHOD
PCB-1248	U	U	µg/Kg	0.30	0.90	3550/8270C
PCB-1254	U	U	µg/Kg	0.30	0.90	3550/8270C
PCB-1260	U	U	µg/Kg	0.30	0.90	3550/8270C
Dioxin	U	U	µg/Kg	30	90	3550/8270C
Azobenzene	U	U	µg/Kg	30	90	3550/8270C
Methoxychlor	U	U	µg/Kg	19	57	3550/8270C
Benzoic Acid	U	U	µg/Kg	30	90	3550/8270C
Aniline	U	U	µg/Kg	30	90	3550/8270C
4-Chloroaniline	U	U	µg/Kg	11	33	3550/8270C
Dibenzofuran	U	U	µg/Kg	30	90	3550/8270C
2-Nitroaniline	U	U	µg/Kg	37	111	3550/8270C
30Nitroaniline	U	U	µg/Kg	30	90	3550/8270C
4-Nitroaniline	U	U	µg/Kg	30	90	3550/8270C
Carbazole	U	U	µg/Kg	30	90	3550/8270C
2,6-Dichlorophenol	U	U	µg/Kg	17	51	3550/8270C
2,3,4,6-Tetrachlorophenol	U	U	µg/Kg	30	90	3550/8270C
2,3,5,6-Tetrachlorophenol	U	U	µg/Kg	30	90	3550/8270C
Pyridine	U	U	µg/Kg	67	201	3550/8270C
FL-PRO (Petroleum Residual Organic Totals) Soil Dilution Factor = 1						
TOTAL PRO (C8-C40)	4.11		mg/Kg	0.01	0.03	FL-PRO
TPHCWG TPH-CWG Speciation Method (Soils) Dilution Factor = 1						
C5-C7 Aromatics	U	U	µg/Kg	5.0	15.0	TPHCWG
C7-C8 Aromatics	U	U	µg/Kg	5.0	15.0	TPHCWG
C8-C10 Aromatics	U	U	µg/Kg	5.0	15.0	TPHCWG
C10-C12 Aromatics	U	U	µg/Kg	5.0	15.0	TPHCWG
C12-C16 Aromatics	U	U	µg/Kg	5.0	15.0	TPHCWG
C16-C21 Aromatics	U	U	µg/Kg	5.0	15.0	TPHCWG
C21-C35 Aromatics	U	U	µg/Kg	5.0	15.0	TPHCWG
C5-C6 Aliphatics	U	U	µg/Kg	5.0	15.0	TPHCWG
C6-C8 Aliphatics	U	U	µg/Kg	5.0	15.0	TPHCWG
C8-C10 Aliphatics	U	U	µg/Kg	5.0	15.0	TPHCWG
C10-C12 Aliphatics	U	U	µg/Kg	5.0	15.0	TPHCWG
C12-C16 Aliphatics	U	U	µg/Kg	5.0	15.0	TPHCWG
C16-C35 Aliphatics	4100		µg/Kg	5.0	15.0	TPHCWG

QC=Qualifier Code as defined by DEP 62-160; U=Undetected; MDL=Minimum Detection Limit; PQL=Practical Quantization Limit.

BLIND PASS SEDIMENT CORE BP-39 (231-238 cm)



Red circle indicates area sampled for GC/MS.

C₈-C₄₀ Table						
PARAMETER	RESULT	QC	UNITS	MDL	PQL	METHOD
Percent Solids	84.5		%	0.1	0.3	EPA 160.3
FL-PRO (Petroleum Residual Organic Totals) Soil Dilution Factor = 1						
TOTAL PRO (C8-C40)	38.0	Q	mg/Kg	0.01	0.03	FL-PRO

QC=Qualifier Code as defined by DEP 62-160; U=Undetected; I=In between the MDL and PQL; Q= Out of hold; MDL=Minimum Detection Limit; PQL=Practical Quantation Limit.

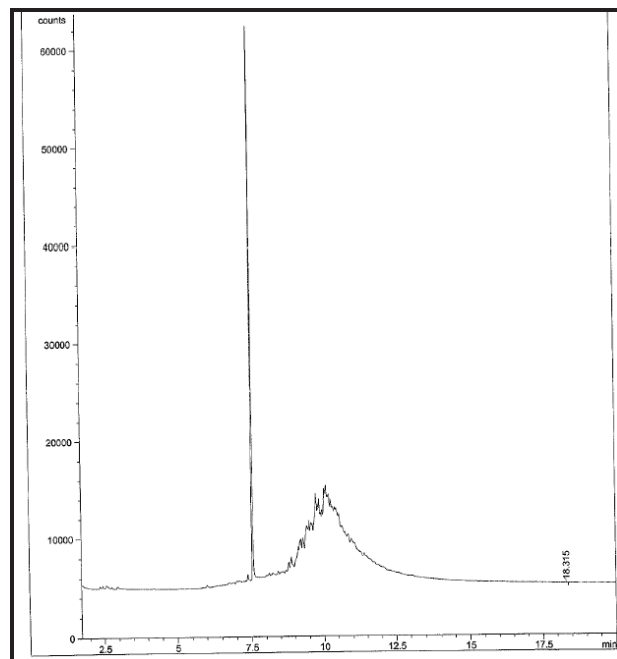

Chromatogram for sediment core BP-39 (231-238 cm).

Petroleum Hydrocarbon Speciation Analysis						
PARAMETER	RESULT	QC	UNITS	MDL	PQL	METHOD
Percent Solids	84.5		%	0.1	0.3	EPA 160.3
8260B VOA Compounds in Solids & Wastes GC/MS Dilution Factor = 1						
Methyl-tert-butyl-ether	1.86	QI	µg/Kg	0.7	2.1	5035/8260B
Methyl Ether Ketone	U	U	µg/Kg	1.0	3.1	5035/8260B
Benzene	U	U	µg/Kg	0.5	1.6	5035/8260B
Toluene	U	U	µg/Kg	0.5	1.5	5035/8260B
Chlorobenzene	U	U	µg/Kg	0.7	2.1	5035/8260B
Ethylbenzene	U	U	µg/Kg	0.7	2.1	5035/8260B
M & p Xylene	U	U	µg/Kg	1.5	4.5	5035/8260B
o-Xylene	U	U	µg/Kg	0.7	2.1	5035/8260B
1,3-Dichlorobenzene	U	U	µg/Kg	1.0	3.0	5035/8260B
1,4-Dichlorobenzene	U	U	µg/Kg	0.8	2.4	5035/8260B
1,2-Dichlorobenzene	U	U	µg/Kg	0.7	2.1	5035/8260B
8270C Semivolatile Organics in Solids by GC/MS Dilution Factor = 1						
N-Nitrosodimethylamine	U	U	µg/Kg	69	207	3550/8270C
Phenol	U	U	µg/Kg	43	129	3550/8270C
2-Methyl Phenol (o-cresol)	U	U	µg/Kg	62	186	3550/8270C
3-Methyl Phenol (m-cresol)	U	U	µg/Kg	46	138	3550/8270C
4-Methyl Phenol (p-cresol)	U	U	µg/Kg	37	111	3550/8270C
Bis (2-Chloroethyl) Ether	U	U	µg/Kg	47	141	3550/8270C
2-Chlorophenol	U	U	µg/Kg	27.0	81.0	3550/8270C
1,3-Dichlorobenzene	U	U	µg/Kg	3.2	9.6	3550/8270C
1,4-Dichlorobenzene	U	U	µg/Kg	2.0	6.0	3550/8270C
Benzyl Alcohol	U	U	µg/Kg	3	9	3550/8270C
1,2-Dichlorobenzene	U	U	µg/Kg	3.5	10.5	3550/8270C
Bis (2-Chloroisopropyl) Ether	U	U	µg/Kg	47	141	3550/8270C
N-Nitrosodi-N-Proplamine	U	U	µg/Kg	24.0	72.0	3550/8270C
Hexachloroethane	U	U	µg/Kg	67	201	3550/8270C
Nitrobenzene	U	U	µg/Kg	38	114	3550/8270C
Isophorone	U	U	µg/Kg	76	228	3550/8270C
2-Nitrophenol	U	U	µg/Kg	78	234	3550/8270C
2,4-Dimethylphenol	U	U	µg/Kg	72	216	3550/8270C
Bis (2-Chloroethoxy)methane	U	U	µg/Kg	81	243	3550/8270C
2,4-Dichlorophenol	U	U	µg/Kg	59	177	3550/8270C
1,2,3-Trichlorobenzene	U	U	µg/Kg	32	96	3550/8270C
1,2,4-Trichlorobenzene	U	U	µg/Kg	42	126	3550/8270C
Naphthalene	U	U	µg/Kg	1	3	3550/8270C
Hexachlorobutadiene	U	U	µg/Kg	14	42	3550/8270C
4-Chloro-3-Methylphenol	U	U	µg/Kg	66	198	3550/8270C
1-Methylnaphthalene	U	U	µg/Kg	1	3	3550/8270C
2-Methylnaphthlene	U	U	µg/Kg	1	3	3550/8270C
Hexachlorocyclopentadiene	U	U	µg/Kg	41	123	3550/8270C
2,3,6-Trichlorophenol	U	U	µg/Kg	98	294	3550/8270C
2,4,5-Trichlorophenol	U	U	µg/Kg	60	180	3550/8270C
2,4,6-Trichlorophenol	U	U	µg/Kg	53	159	3550/8270C
2-Chloronaphthalene	U	U	µg/Kg	34	102	3550/8270C
Dimethyl Phthalate	U	U	µg/Kg	38	114	3550/8270C
Acenaphthylene	1.20	I	µg/Kg	2.0	6.0	3550/8270C
2,6-Dinitrotoluene	U	U	µg/Kg	26	78	3550/8270C
Acenaphthene	U	U	µg/Kg	1.3	3.9	3550/8270C

Petroleum Hydrocarbon Speciation Analysis (continued)						
PARAMETER	RESULT	QC	UNITS	MDL	PQL	METHOD
2,4-Dinitrotoluene	U	U	µg/Kg	41	123	3550/8270C
4-Nitrophenol	U	U	µg/Kg	37	111	3550/8270C
Diethyl Phthalate	U	U	µg/Kg	35	105	3550/8270C
Fluorene	U	U	µg/Kg	1.0	3.0	3550/8270C
4-Chlorophenyl Phenyl Ether	U	U	µg/Kg	45	135	3550/8270C
4,6-Dinitro-2-Methylphenol	U	U	µg/Kg	36	108	3550/8270C
N-Nitrosodiphenylamine	U	U	µg/Kg	51	153	3550/8270C
4-Bromophenyl Phenyl Ether	U	U	µg/Kg	38	114	3550/8270C
Hexachlorobenzene	U	U	µg/Kg	36	108	3550/8270C
Pentachlorophenol	U	U	µg/Kg	1.7	5.1	3550/8270C
Phenanthrene	U	U	µg/Kg	2	6	3550/8270C
Anthracene	U	U	µg/Kg	0.6	1.8	3550/8270C
Di-N-Butyl Phthalate	U	U	µg/Kg	34	102	3550/8270C
Fluoranthene	2.47	I	µg/Kg	1.6	4.8	3550/8270C
Benzidine	U	U	µg/Kg	33	99	3550/8270C
Pyrene	9.49	I	µg/Kg	2	6	3550/8270C
Butyl Benzyl Phthalate	U	U	µg/Kg	50	150	3550/8270C
Benzo(A)Anthracene	5.70	I	µg/Kg	1	3	3550/8270C
3,3-Dichlorobenzidine	U	U	µg/Kg	100	300	3550/8270C
Chrysene	3.35	I	µg/Kg	1	3	3550/8270C
Bis (2 Ethylhexyl) Phthalate	U	U	µg/Kg	39	117	3550/8270C
Di-N-Octyl Phthalate	U	U	µg/Kg	44	132	3550/8270C
Benzo(B)Fluoranthene	2.56	I	µg/Kg	1	3	3550/8270C
Benzo(K)Fluoranthene	U	U	µg/Kg	1	3	3550/8270C
Benzo(A)Pyrene	4.18	I	µg/Kg	1	3	3550/8270C
Indeno(1,2,3-CD)Pyrene	U	U	µg/Kg	2	6	3550/8270C
Dibenzo (A,H) Anthracene	U	U	µg/Kg	2	6	3550/8270C
Benzo(G,H,I)Perylene	U	U	µg/Kg	2	6	3550/8270C
Bis-2-ethylexyl Adipate	U	U	µg/Kg	33	99	3550/8270C
Aldrin	U	U	µg/Kg	1.0	3.0	3550/8270C
-BHC	U	U	µg/Kg	3.0	9.0	3550/8270C
-BHC	U	U	µg/Kg	3.0	9.0	3550/8270C
-BHC	U	U	µg/Kg	3.0	9.0	3550/8270C
-BHC (Lindane)	U	U	µg/Kg	1.0	3.0	3550/8270C
Clordane	U	U	µg/Kg	1.0	3.0	3550/8270C
4,4'-DDD	U	U	µg/Kg	2	6	3550/8270C
4,4'-DDE	U	U	µg/Kg	1.39	4017	3550/8270C
4,4'-DDT	U	U	µg/Kg	1.69	5.07	3550/8270C
Dieldrin	U	U	µg/Kg	0.840	2.520	3550/8270C
Endosulfan I	U	U	µg/Kg	1.100	3.300	3550/8270C
Endosulfan II	U	U	µg/Kg	1.60	4.80	3550/8270C
Endosulfan Sulfate	U	U	µg/Kg	1.70	5.10	3550/8270C
Endrin	U	U	µg/Kg	1.800	5.400	3550/8270C
Endrin Aldehyde	U	U	µg/Kg	1.900	5.700	3550/8270C
Heptachlor	U	U	µg/Kg	1.78	5.34	3550/8270C
Heptachlor Epoxide	U	U	µg/Kg	1.68	5.04	3550/8270C
Toxaphene	U	U	µg/Kg	1.90	5.70	3550/8270C
PCB-1016	U	U	µg/Kg	0.30	0.90	3550/8270C
PCB-1221	U	U	µg/Kg	0.30	0.90	3550/8270C
PCB-1232	U	U	µg/Kg	0.30	0.90	3550/8270C
PCB-1242	U	U	µg/Kg	0.30	0.90	3550/8270C

Petroleum Hydrocarbon Speciation Analysis (continued)						
PARAMETER	RESULT	QC	UNITS	MDL	PQL	METHOD
PCB-1248	U	U	µg/Kg	0.30	0.90	3550/8270C
PCB-1254	U	U	µg/Kg	0.30	0.90	3550/8270C
PCB-1260	U	U	µg/Kg	0.30	0.90	3550/8270C
Dioxin	U	U	µg/Kg	30	90	3550/8270C
Azobenzene	U	U	µg/Kg	30	90	3550/8270C
Methoxychlor	U	U	µg/Kg	19	57	3550/8270C
Benzoic Acid	U	U	µg/Kg	30	90	3550/8270C
Aniline	U	U	µg/Kg	30	90	3550/8270C
4-Chloroaniline	U	U	µg/Kg	11	33	3550/8270C
Dibenzofuran	U	U	µg/Kg	30	90	3550/8270C
2-Nitroaniline	U	U	µg/Kg	37	111	3550/8270C
30Nitroaniline	U	U	µg/Kg	30	90	3550/8270C
4-Nitroaniline	U	U	µg/Kg	30	90	3550/8270C
Carbazole	U	U	µg/Kg	30	90	3550/8270C
2,6-Dichlorophenol	U	U	µg/Kg	17	51	3550/8270C
2,3,4,6-Tetrachlorophenol	U	U	µg/Kg	30	90	3550/8270C
2,3,5,6-Tetrachlorophenol	U	U	µg/Kg	30	90	3550/8270C
Pyridine	U	U	µg/Kg	67	201	3550/8270C
FL-PRO (Petroleum Residual Organic Totals) Soil Dilution Factor = 1						
TOTAL PRO (C8-C40)	38.0		mg/Kg	0.01	0.03	FL-PRO
TPHCWG TPH-CWG Speciation Method (Soils) Dilution Factor = 1						
C5-C7 Aromatics	U	U	µg/Kg	5.0	15.0	TPHCWG
C7-C8 Aromatics	U	U	µg/Kg	5.0	15.0	TPHCWG
C8-C10 Aromatics	U	U	µg/Kg	5.0	15.0	TPHCWG
C10-C12 Aromatics	U	U	µg/Kg	5.0	15.0	TPHCWG
C12-C16 Aromatics	13.2	QI	µg/Kg	5.0	15.0	TPHCWG
C16-C21 Aromatics	15.7	Q	µg/Kg	5.0	15.0	TPHCWG
C21-C35 Aromatics	U	U	µg/Kg	5.0	15.0	TPHCWG
C5-C6 Aliphatics	U	U	µg/Kg	5.0	15.0	TPHCWG
C6-C8 Aliphatics	U	U	µg/Kg	5.0	15.0	TPHCWG
C8-C10 Aliphatics	U	U	µg/Kg	5.0	15.0	TPHCWG
C10-C12 Aliphatics	U	U	µg/Kg	5.0	15.0	TPHCWG
C12-C16 Aliphatics	U	U	µg/Kg	5.0	15.0	TPHCWG
C16-C35 Aliphatics	38,000	Q	µg/Kg	5.0	15.0	TPHCWG

QC=Qualifier Code as defined by DEP 62-160; U=Undetected; MDL=Minimum Detection Limit; PQL=Practical Quantation Limit.

BLIND PASS SEDIMENT CORE BP-39 (256-266 cm)

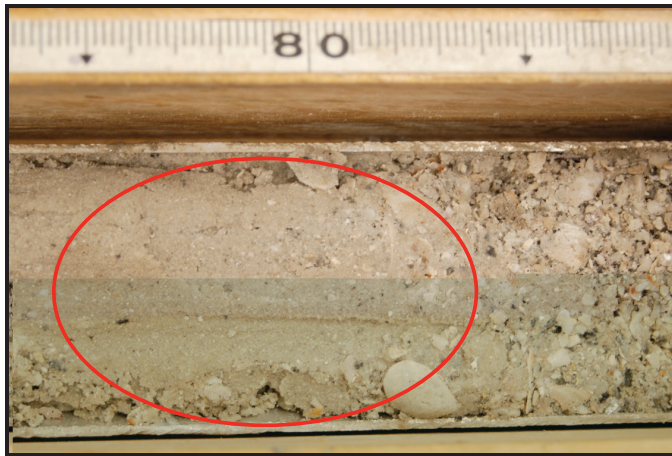

Red circle indicates area sampled for GC/MS analysis.

C₈-C₄₀ Table						
PARAMETER	RESULT	QC	UNITS	MDL	PQL	METHOD
Percent Solids	82.4		%	0.1	0.3	EPA 160.3
FL-PRO (Petroleum Residual Organic Totals) Soil Dilution Factor = 1						
TOTAL PRO (C8-C40)	3.36	U	mg/Kg	0.01	0.03	FL-PRO

QC=Qualifier Code as defined by DEP 62-160; U=Undetected; I=In between the MDL and PQL; Q= Out of hold; MDL=Minimum Detection Limit; PQL=Practical Quantation Limit.

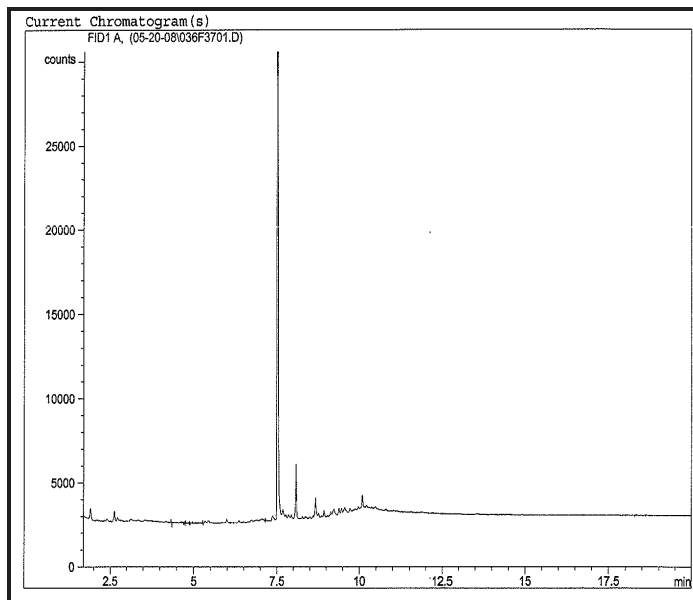

Chromatogram for sediment core BP-39 (256-266 cm).

Petroleum Hydrocarbon Speciation Analysis						
PARAMETER	RESULT	QC	UNITS	MDL	PQL	METHOD

Petroleum Hydrocarbon Speciation Analysis (continued)						
PARAMETER	RESULT	QC	UNITS	MDL	PQL	METHOD
2,4-Dinitrotoluene	U	U	µg/Kg	41	123	3550/8270C
4-Nitrophenol	U	U	µg/Kg	37	111	3550/8270C
Diethyl Phthalate	U	U	µg/Kg	35	105	3550/8270C
Fluorene	U	U	µg/Kg	1.0	3.0	3550/8270C
4-Chlorophenyl Phenyl Ether	U	U	µg/Kg	45	135	3550/8270C
4,6-Dinitro-2-Methylphenol	U	U	µg/Kg	36	108	3550/8270C
N-Nitrosodiphenylamine	U	U	µg/Kg	51	153	3550/8270C
4-Bromophenyl Phenyl Ether	U	U	µg/Kg	38	114	3550/8270C
Hexachlorobenzene	U	U	µg/Kg	36	108	3550/8270C
Pentachlorophenol	U	U	µg/Kg	1.7	5.1	3550/8270C
Phenanthrene	U	U	µg/Kg	2	6	3550/8270C
Anthracene	U	U	µg/Kg	0.6	1.8	3550/8270C
Di-N-Butyl Phthalate	U	U	µg/Kg	34	102	3550/8270C
Fluoranthene	U	U	µg/Kg	1.6	4.8	3550/8270C
Benzidine	U	U	µg/Kg	33	99	3550/8270C
Pyrene	U	U	µg/Kg	2	6	3550/8270C
Butyl Benzyl Phthalate	U	U	µg/Kg	50	150	3550/8270C
Benzo(A)Anthracene	U	U	µg/Kg	1	3	3550/8270C
3,3-Dichlorobenzidine	U	U	µg/Kg	100	300	3550/8270C
Chrysene	U	U	µg/Kg	1	3	3550/8270C
Bis (2 Ethylhexyl) Phthalate	U	U	µg/Kg	39	117	3550/8270C
Di-N-Octyl Phthalate	U	U	µg/Kg	44	132	3550/8270C
Benzo(B)Fluoranthene	U	U	µg/Kg	1	3	3550/8270C
Benzo(K)Fluoranthene	U	U	µg/Kg	1	3	3550/8270C
Benzo(A)Pyrene	U	U	µg/Kg	1	3	3550/8270C
Indeno(1,2,3-CD)Pyrene	U	U	µg/Kg	2	6	3550/8270C
Dibenzo (A,H) Anthracene	U	U	µg/Kg	2	6	3550/8270C
Benzo(G,H,I)Perylene	U	U	µg/Kg	2	6	3550/8270C
Bis-2-ethylexyl Adipate	U	U	µg/Kg	33	99	3550/8270C
Aldrin	U	U	µg/Kg	1.0	3.0	3550/8270C
-BHC	U	U	µg/Kg	3.0	9.0	3550/8270C
-BHC	U	U	µg/Kg	3.0	9.0	3550/8270C
-BHC	U	U	µg/Kg	3.0	9.0	3550/8270C
-BHC (Lindane)	U	U	µg/Kg	1.0	3.0	3550/8270C
Clordane	U	U	µg/Kg	1.0	3.0	3550/8270C
4,4'-DDD	U	U	µg/Kg	2	6	3550/8270C
4,4'-DDE	U	U	µg/Kg	1.39	4017	3550/8270C
4,4'-DDT	U	U	µg/Kg	1.69	5.07	3550/8270C
Dieldrin	U	U	µg/Kg	0.840	2.520	3550/8270C
Endosulfan I	U	U	µg/Kg	1.100	3.300	3550/8270C
Endosulfan II	U	U	µg/Kg	1.60	4.80	3550/8270C
Endosulfan Sulfate	U	U	µg/Kg	1.70	5.10	3550/8270C
Endrin	U	U	µg/Kg	1.800	5.400	3550/8270C
Endrin Aldehyde	U	U	µg/Kg	1.900	5.700	3550/8270C
Heptachlor	U	U	µg/Kg	1.78	5.34	3550/8270C
Heptachlor Epoxide	U	U	µg/Kg	1.68	5.04	3550/8270C
Toxaphene	U	U	µg/Kg	1.90	5.70	3550/8270C
PCB-1016	U	U	µg/Kg	0.30	0.90	3550/8270C
PCB-1221	U	U	µg/Kg	0.30	0.90	3550/8270C
PCB-1232	U	U	µg/Kg	0.30	0.90	3550/8270C
PCB-1242	U	U	µg/Kg	0.30	0.90	3550/8270C

Petroleum Hydrocarbon Speciation Analysis (continued)						
PARAMETER	RESULT	QC	UNITS	MDL	PQL	METHOD
PCB-1248	U	U	µg/Kg	0.30	0.90	3550/8270C
PCB-1254	U	U	µg/Kg	0.30	0.90	3550/8270C
PCB-1260	U	U	µg/Kg	0.30	0.90	3550/8270C
Dioxin	U	U	µg/Kg	30	90	3550/8270C
Azobenzene	U	U	µg/Kg	30	90	3550/8270C
Methoxychlor	U	U	µg/Kg	19	57	3550/8270C
Benzoic Acid	U	U	µg/Kg	30	90	3550/8270C
Aniline	U	U	µg/Kg	30	90	3550/8270C
4-Chloroaniline	U	U	µg/Kg	11	33	3550/8270C
Dibenzofuran	U	U	µg/Kg	30	90	3550/8270C
2-Nitroaniline	U	U	µg/Kg	37	111	3550/8270C
30Nitroaniline	U	U	µg/Kg	30	90	3550/8270C
4-Nitroaniline	U	U	µg/Kg	30	90	3550/8270C
Carbazole	U	U	µg/Kg	30	90	3550/8270C
2,6-Dichlorophenol	U	U	µg/Kg	17	51	3550/8270C
2,3,4,6-Tetrachlorophenol	U	U	µg/Kg	30	90	3550/8270C
2,3,5,6-Tetrachlorophenol	U	U	µg/Kg	30	90	3550/8270C
Pyridine	U	U	µg/Kg	67	201	3550/8270C
FL-PRO (Petroleum Residual Organic Totals) Soil Dilution Factor = 1						
TOTAL PRO (C8-C40)	3.36		mg/Kg	0.01	0.03	FL-PRO
TPHCWG TPH-CWG Speciation Method (Soils) Dilution Factor = 1						
C5-C7 Aromatics	U	U	µg/Kg	5.0	15.0	TPHCWG
C7-C8 Aromatics	U	U	µg/Kg	5.0	15.0	TPHCWG
C8-C10 Aromatics	U	U	µg/Kg	5.0	15.0	TPHCWG
C10-C12 Aromatics	U	U	µg/Kg	5.0	15.0	TPHCWG
C12-C16 Aromatics	U	U	µg/Kg	5.0	15.0	TPHCWG
C16-C21 Aromatics	U	U	µg/Kg	5.0	15.0	TPHCWG
C21-C35 Aromatics	U	U	µg/Kg	5.0	15.0	TPHCWG
C5-C6 Aliphatics	U	U	µg/Kg	5.0	15.0	TPHCWG
C6-C8 Aliphatics	U	U	µg/Kg	5.0	15.0	TPHCWG
C8-C10 Aliphatics	U	U	µg/Kg	5.0	15.0	TPHCWG
C10-C12 Aliphatics	U	U	µg/Kg	5.0	15.0	TPHCWG
C12-C16 Aliphatics	U	U	µg/Kg	5.0	15.0	TPHCWG
C16-C35 Aliphatics	3360		µg/Kg	5.0	15.0	TPHCWG

QC=Qualifier Code as defined by DEP 62-160; U=Undetected; MDL=Minimum Detection Limit; PQL=Practical Quantization Limit.

BLIND PASS SEDIMENT CORE BP-97 (192-197 cm)

NO PHOTO AVAILABLE

C₈-C₄₀ Table						
PARAMETER	RESULT	QC	UNITS	MDL	PQL	METHOD
Percent Solids	57.5		%	0.1	0.3	EPA 160.3
FL-PRO (Petroleum Residual Organic Totals) Soil Dilution Factor = 1						
TOTAL PRO (C8-C40)	30.6	U	mg/Kg	0.01	0.03	FL-PRO

QC=Qualifier Code as defined by DEP 62-160; U=Undetected; MDL=Minimum Detection Limit; PQL=Practical Quantitation Limit.

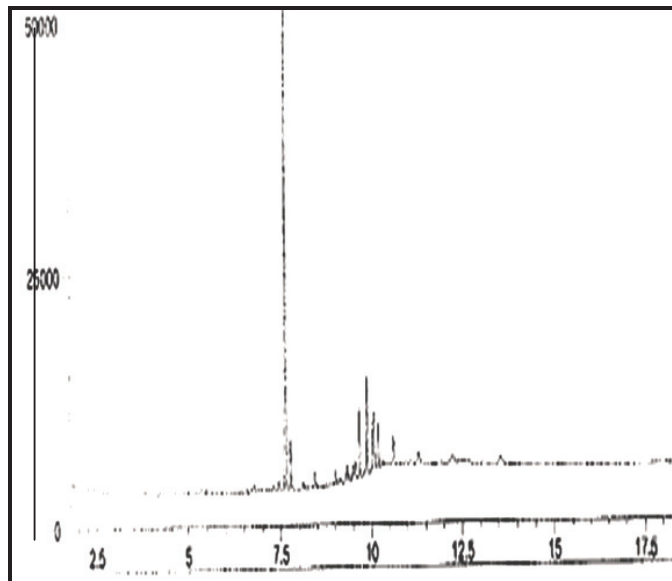

Chromatogram for sediment core BP-97 (192-197 cm).

Petroleum Hydrocarbon Speciation Analysis						
PARAMETER	RESULT	QC	UNITS	MDL	PQL	METHOD
Percent Solids	57.5		%	0.1	0.3	EPA 160.3
8260B VOA Compounds in Solids & Wastes GC/MS Dilution Factor = 1.49						
Methyl-tert-butyl-ether	U	U	µg/Kg	1.9	5.7	5030/8260B
Benzene	U	U	µg/Kg	0.85	2.55	5030/8260B
Toluene	7.84		µg/Kg	1.4	4.2	5030/8260B
Chlorobenzene	U	U	µg/Kg	2.3	6.9	5030/8260B
Ethylbenzene	U	U	µg/Kg	1.5	4.5	5030/8260B
M & p Xylene	U	U	µg/Kg	1.3	3.9	5030/8260B
o-Xylene	U	U	µg/Kg	1.1	3.3	5030/8260B
1,3-Dichlorobenzene	U	U	µg/Kg	3.2	9.6	5030/8260B
1,4-Dichlorobenzene	U	U	µg/Kg	2.0	6.0	5030/8260B
1,2-Dichlorobenzene	U	U	µg/Kg	3.5	10.5	5030/8260B
8270C Semivolatile Organics in Solids by GC/MS Dilution Factor = 1						
N-Nitrosodimethylamine	U	U	µg/Kg	69	207	3550/8270C
Phenol	U	U	µg/Kg	43	129	3550/8270C
2-Methyl Phenol (o-cresol)	U	U	µg/Kg	62	186	3550/8270C
3-Methyl Phenol (m-cresol)	U	U	µg/Kg	46	138	3550/8270C
4-Methyl Phenol (p-cresol)	U	U	µg/Kg	37	111	3550/8270C
Bis (2-Chloroethyl) Ether	U	U	µg/Kg	47	141	3550/8270C
2-Chlorophenol	U	U	µg/Kg	27.0	81.0	3550/8270C
1,3-Dichlorobenzene	U	U	µg/Kg	3.2	9.6	3550/8270C
1,4-Dichlorobenzene	U	U	µg/Kg	2.0	6.0	3550/8270C
Benzyl Alcohol	U	U	µg/Kg	3	9	3550/8270C
1,2-Dichlorobenzene	U	U	µg/Kg	3.5	10.5	3550/8270C
Bis (2-Chloroisopropyl) Ether	U	U	µg/Kg	47	141	3550/8270C
N-Nitrosodi-N-Proplamine	U	U	µg/Kg	24.0	72.0	3550/8270C
Hexachloroethane	U	U	µg/Kg	67	201	3550/8270C
Nitrobenzene	U	U	µg/Kg	38	114	3550/8270C
Isophorone	U	U	µg/Kg	76	228	3550/8270C
2-Nitrophenol	U	U	µg/Kg	78	234	3550/8270C
2,4-Dimethylphenol	U	U	µg/Kg	72	216	3550/8270C
Bis (2-Chloroethoxy)methane	U	U	µg/Kg	81	243	3550/8270C
2,4-Dichlorophenol	U	U	µg/Kg	59	177	3550/8270C
1,2,3-Trichlorobenzene	U	U	µg/Kg	32	96	3550/8270C
1,2,4-Trichlorobenzene	U	U	µg/Kg	42	126	3550/8270C
Naphthalene	U	U	µg/Kg	1	3	3550/8270C
Hexachlorobutadiene	U	U	µg/Kg	14	42	3550/8270C
4-Chloro-3-Methylphenol	U	U	µg/Kg	66	198	3550/8270C
1-Methylnaphthalene	U	U	µg/Kg	1	3	3550/8270C
2-Methylnaphthlene	U	U	µg/Kg	1	3	3550/8270C
Hexachlorocyclopentadiene	U	U	µg/Kg	41	123	3550/8270C
2,3,6-Trichlorophenol	U	U	µg/Kg	98	294	3550/8270C
2,4,5-Trichlorophenol	U	U	µg/Kg	60	180	3550/8270C
2,4,6-Trichlorophenol	U	U	µg/Kg	53	159	3550/8270C
2-Chloronaphthalene	U	U	µg/Kg	34	102	3550/8270C
Dimethyl Phthalate	U	U	µg/Kg	38	114	3550/8270C
Acenaphthylene	U	U	µg/Kg	2.0	6.0	3550/8270C
2,6-Dinitrotoluene	U	U	µg/Kg	26	78	3550/8270C
Acenaphthene	U	U	µg/Kg	1.3	3.9	3550/8270C
2,4-Dinitrophenol	U	U	µg/Kg	34	102	3550/8270C

Petroleum Hydrocarbon Speciation Analysis (continued)						
PARAMETER	RESULT	QC	UNITS	MDL	PQL	METHOD
2,4-Dinitrotoluene	U	U	µg/Kg	41	123	3550/8270C
4-Nitrophenol	U	U	µg/Kg	37	111	3550/8270C
Diethyl Phthalate	U	U	µg/Kg	35	105	3550/8270C
Fluorene	U	U	µg/Kg	1.0	3.0	3550/8270C
4-Chlorophenyl Phenyl Ether	U	U	µg/Kg	45	135	3550/8270C
4,6-Dinitro-2-Methylphenol	U	U	µg/Kg	36	108	3550/8270C
N-Nitrosodiphenylamine	U	U	µg/Kg	51	153	3550/8270C
4-Bromophenyl Phenyl Ether	U	U	µg/Kg	38	114	3550/8270C
Hexachlorobenzene	U	U	µg/Kg	36	108	3550/8270C
Pentachlorophenol	U	U	µg/Kg	1.7	5.1	3550/8270C
Phenanthrene	U	U	µg/Kg	2	6	3550/8270C
Anthracene	U	U	µg/Kg	0.6	1.8	3550/8270C
Di-N-Butyl Phthalate	333		µg/Kg	34	102	3550/8270C
Fluoranthene	U	U	µg/Kg	1.6	4.8	3550/8270C
Benzidine	U	U	µg/Kg	33	99	3550/8270C
Pyrene	U	U	µg/Kg	2	6	3550/8270C
Butyl Benzyl Phthalate	U	U	µg/Kg	50	150	3550/8270C
Benzo(A)Anthracene	U	U	µg/Kg	1	3	3550/8270C
3,3-Dichlorobenzidine	U	U	µg/Kg	100	300	3550/8270C
Chrysene	U	U	µg/Kg	1	3	3550/8270C
Bis (2 Ethylhexyl) Phthalate	432		µg/Kg	39	117	3550/8270C
Di-N-Octyl Phthalate	U	U	µg/Kg	44	132	3550/8270C
Benzo(B)Fluoranthene	U	U	µg/Kg	1	3	3550/8270C
Benzo(K)Fluoranthene	U	U	µg/Kg	1	3	3550/8270C
Benzo(A)Pyrene	U	U	µg/Kg	1	3	3550/8270C
Indeno(1,2,3-CD)Pyrene	U	U	µg/Kg	2	6	3550/8270C
Dibenzo (A,H) Anthracene	U	U	µg/Kg	2	6	3550/8270C
Benzo(G,H,I)Perylene	U	U	µg/Kg	2	6	3550/8270C
Bis-2-ethylexyl Adipate	U	U	µg/Kg	33	99	3550/8270C
Aldrin	U	U	µg/Kg	1.0	3.0	3550/8270C
-BHC	U	U	µg/Kg	3.0	9.0	3550/8270C
-BHC	U	U	µg/Kg	3.0	9.0	3550/8270C
-BHC	U	U	µg/Kg	3.0	9.0	3550/8270C
-BHC (Lindane)	U	U	µg/Kg	1.0	3.0	3550/8270C
Clordane	U	U	µg/Kg	1.0	3.0	3550/8270C
4,4'-DDD	U	U	µg/Kg	2	6	3550/8270C
4,4'-DDE	U	U	µg/Kg	1.39	4017	3550/8270C
4,4'-DDT	U	U	µg/Kg	1.69	5.07	3550/8270C
Dieldrin	U	U	µg/Kg	0.840	2.520	3550/8270C
Endosulfan I	U	U	µg/Kg	1.100	3.300	3550/8270C
Endosulfan II	U	U	µg/Kg	1.60	4.80	3550/8270C
Endosulfan Sulfate	U	U	µg/Kg	1.70	5.10	3550/8270C
Endrin	U	U	µg/Kg	1.800	5.400	3550/8270C
Endrin Aldehyde	U	U	µg/Kg	1.900	5.700	3550/8270C
Heptachlor	U	U	µg/Kg	1.78	5.34	3550/8270C
Heptachlor Epoxide	U	U	µg/Kg	1.68	5.04	3550/8270C
Toxaphene	U	U	µg/Kg	1.90	5.70	3550/8270C
PCB-1016	U	U	µg/Kg	0.30	0.90	3550/8270C
PCB-1221	U	U	µg/Kg	0.30	0.90	3550/8270C
PCB-1232	U	U	µg/Kg	0.30	0.90	3550/8270C
PCB-1242	U	U	µg/Kg	0.30	0.90	3550/8270C

Petroleum Hydrocarbon Speciation Analysis (continued)						
PARAMETER	RESULT	QC	UNITS	MDL	PQL	METHOD
PCB-1248	U	U	µg/Kg	0.30	0.90	3550/8270C
PCB-1254	U	U	µg/Kg	0.30	0.90	3550/8270C
PCB-1260	U	U	µg/Kg	0.30	0.90	3550/8270C
Dioxin	U	U	µg/Kg	30	90	3550/8270C
Azobenzene	U	U	µg/Kg	30	90	3550/8270C
Methoxychlor	U	U	µg/Kg	19	57	3550/8270C
Benzoic Acid	U	U	µg/Kg	30	90	3550/8270C
Aniline	U	U	µg/Kg	30	90	3550/8270C
4-Chloroaniline	U	U	µg/Kg	11	33	3550/8270C
Dibenzofuran	U	U	µg/Kg	30	90	3550/8270C
2-Nitroaniline	U	U	µg/Kg	37	111	3550/8270C
30Nitroaniline	U	U	µg/Kg	30	90	3550/8270C
4-Nitroaniline	U	U	µg/Kg	30	90	3550/8270C
Carbazole	U	U	µg/Kg	30	90	3550/8270C
2,6-Dichlorophenol	U	U	µg/Kg	17	51	3550/8270C
2,3,4,6-Tetrachlorophenol	U	U	µg/Kg	30	90	3550/8270C
2,3,5,6-Tetrachlorophenol	U	U	µg/Kg	30	90	3550/8270C
Pyridine	U	U	µg/Kg	67	201	3550/8270C
FL-PRO (Petroleum Residual Organic Totals) Soil Dilution Factor = 1						
TOTAL PRO (C8-C40)	30.6		mg/Kg	0.01	0.03	FL-PRO
TPHCWG TPH-CWG Speciation Method (Soils) Dilution Factor = 1						
C5-C7 Aromatics	U	U	µg/Kg	5.0	15.0	TPHCWG
C7-C8 Aromatics	U	U	µg/Kg	5.0	15.0	TPHCWG
C8-C10 Aromatics	U	U	µg/Kg	5.0	15.0	TPHCWG
C10-C12 Aromatics	U	U	µg/Kg	5.0	15.0	TPHCWG
C12-C16 Aromatics	U	U	µg/Kg	5.0	15.0	TPHCWG
C16-C21 Aromatics	U	U	µg/Kg	5.0	15.0	TPHCWG
C21-C35 Aromatics	U	U	µg/Kg	5.0	15.0	TPHCWG
C5-C6 Aliphatics	U	U	µg/Kg	5.0	15.0	TPHCWG
C6-C8 Aliphatics	U	U	µg/Kg	5.0	15.0	TPHCWG
C8-C10 Aliphatics	U	U	µg/Kg	5.0	15.0	TPHCWG
C10-C12 Aliphatics	U	U	µg/Kg	5.0	15.0	TPHCWG
C12-C16 Aliphatics	U	U	µg/Kg	5.0	15.0	TPHCWG
C16-C35 Aliphatics	31.8		µg/Kg	5.0	15.0	TPHCWG

QC=Qualifier Code as defined by DEP 62-160; U=Undetected; MDL=Minimum Detection Limit; PQL=Practical Quantitation Limit.

BOUCHARD 155 REFERENCE SAMPLE

C₈-C₄₀ Table						
PARAMETER	RESULT	QC	UNITS	MDL	PQL	METHOD
Percent Solids			%	0.1	0.3	EPA 160.3
FL-PRO (Petroleum Residual Organic Totals) Soil Dilution Factor = 1						
TOTAL PRO (C8-C40)	206000	U	mg/Kg	0.01	0.03	FL-PRO

QC=Qualifier Code as defined by DEP 62-160; U=Undetected; I=In between the MDL and PQL; Q= Out of hold; MDL=Minimum Detection Limit; PQL=Practical Quantation Limit.

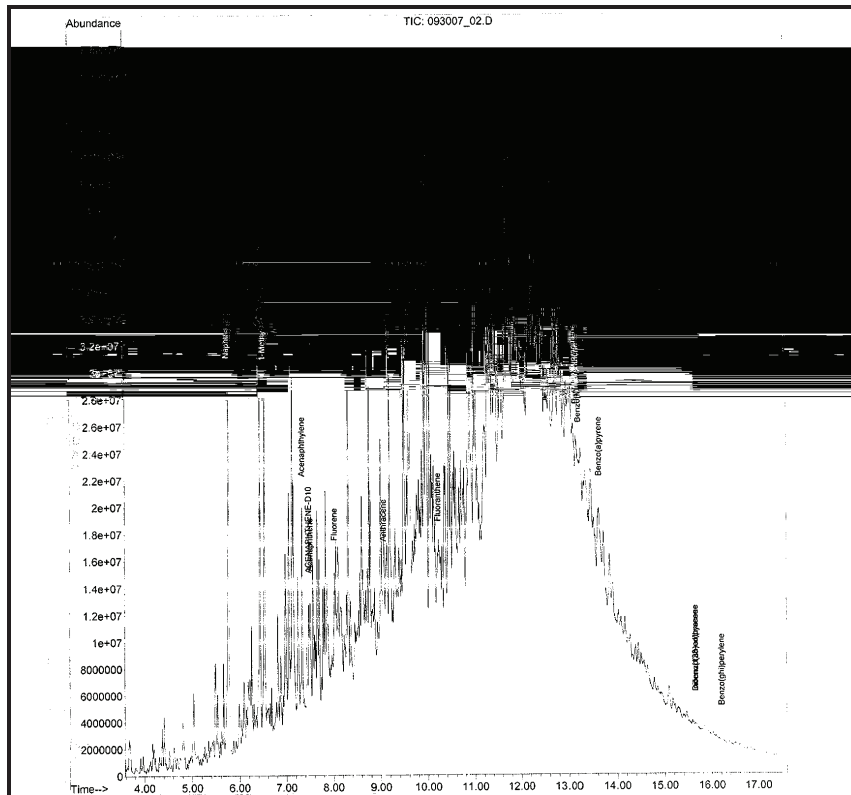

Chromatogram for the *Bouchard 155* sample.

Petroleum Hydrocarbon Speciation Analysis						
PARAMETER	RESULT	QC	UNITS	MDL	PQL	METHOD
Percent Solids	N/A		%	0.1	0.3	EPA 160.3
8260B VOA Compounds in Solids & Wastes GC/MS Dilution Factor = 5000						
Methyl-tert-butyl-ether	U	QU	µg/Kg	9500.0	28500.0	5030/8260B
Benzene	9550	QI	µg/Kg	4250.0	12750.0	5030/8260B
Toluene	47800	Q	µg/Kg	7000.0	21000.0	5030/8260B
Chlorobenzene	U	QU	µg/Kg	11500.0	34500.0	5030/8260B
Ethylbenzene	21900	QI	µg/Kg	7500.0	22500.0	5030/8260B
M & p Xylene	84600	Q	µg/Kg	6500.0	19500.0	5030/8260B
o-Xylene	30800	Q	µg/Kg	5500.0	16500.0	5030/8260B
1,3-Dichlorobenzene	U	QU	µg/Kg	16000.0	48000.0	5030/8260B
1,4-Dichlorobenzene	U	QU	µg/Kg	10000.0	30000.0	5030/8260B
1,2-Dichlorobenzene	U	QU	µg/Kg	17500.0	52500.0	5030/8260B
8270C Semivolatile Organics in Solids by GC/MS Dilution Factor = 10000						
Naphthalene	6100000	Q	µg/Kg	10700.0	32100.0	3550/8270C
1-Methylnaphthalene	4950000	Q	µg/Kg	8400.0	25200.0	3550/8270C
2-Methylnaphthalene	7300000	Q	µg/Kg	10500.0	31500.0	3550/8270C
Acenaphthene	970000	Q	µg/Kg	12500.0	37500.0	3550/8270C
Acenaphthylene	U	QU	µg/Kg	10100.0	30300.0	3550/8270C
Fluorene	600000	Q	µg/Kg	9900.0	29700.0	3550/8270C
Phenanthrene	1700000	Q	µg/Kg	19600.0	48300.0	3550/8270C
Anthracene	290000	Q	µg/Kg	6100.0	18300.0	3550/8270C
Fluoranthene	270000	Q	µg/Kg	16100.0	48300.0	3550/8270C
Pyrene	1100000	Q	µg/Kg	19700.0	59100.0	3550/8270C
Benzo(A)Anthracene	1300000	Q	µg/Kg	12500.0	37500.0	3550/8270C
Chrysene	2400000	Q	µg/Kg	12500.0	37500.0	3550/8270C
Benzo(B)Fluoranthene	625000	Q	µg/Kg	10100.0	30300.0	3550/8270C
Benzo(K)Fluoranthene	U	QU	µg/Kg	7000.0	21000.0	3550/8270C
Benzo(A)Pyrene	660000	Q	µg/Kg	8300.0	24900.0	3550/8270C
Indeno(1,2,3-CD)Pyrene	U	QU	µg/Kg	17400.0	52200.0	3550/8270C
Dibenzo (A,H) Anthracene	U	QU	µg/Kg	10900.0	32700.0	3550/8270C
Benzo(G,H,I)Perylene	U	QU	µg/Kg	15700.0	47100.0	3550/8270C
FL-PRO (Petroleum Residual Organic Totals) Soil Dilution Factor = 1						
TOTAL PRO (C8-C40)	206000	Q	mg/Kg	0.01	0.03	FL-PRO
TPHCWG TPH-CWG Speciation Method (Soils) Dilution Factor = 1						
C5-C7 Aromatics	U	QU	µg/Kg	5.0	15.0	TPHCWG
C7-C8 Aromatics	83000	Q	µg/Kg	5.0	15.0	TPHCWG
C8-C10 Aromatics	U	QU	µg/Kg	5.0	15.0	TPHCWG
C10-C12 Aromatics	U	QU	µg/Kg	5.0	15.0	TPHCWG
C12-C16 Aromatics	19920000	Q	µg/Kg	5.0	15.0	TPHCWG
C16-C21 Aromatics	8350000	Q	µg/Kg	5.0	15.0	TPHCWG
C21-C35 Aromatics	U	QU	µg/Kg	5.0	15.0	TPHCWG
C5-C6 Aliphatics	U	QU	µg/Kg	5.0	15.0	TPHCWG
C6-C8 Aliphatics	U	QU	µg/Kg	5.0	15.0	TPHCWG
C8-C10 Aliphatics	1930000	Q	µg/Kg	5.0	15.0	TPHCWG
C10-C12 Aliphatics	4300000	Q	µg/Kg	5.0	15.0	TPHCWG
C12-C16 Aliphatics	21200000	Q	µg/Kg	5.0	15.0	TPHCWG
C16-C35 Aliphatics	160000000	Q	µg/Kg	5.0	15.0	TPHCWG

QC=Qualifier Code as defined by DEP 62-160; U=Undetected; MDL=Minimum Detection Limit; PQL=Practical Quantitation Limit.

INSTRUMENT CALIBRATION FOR GC/MS

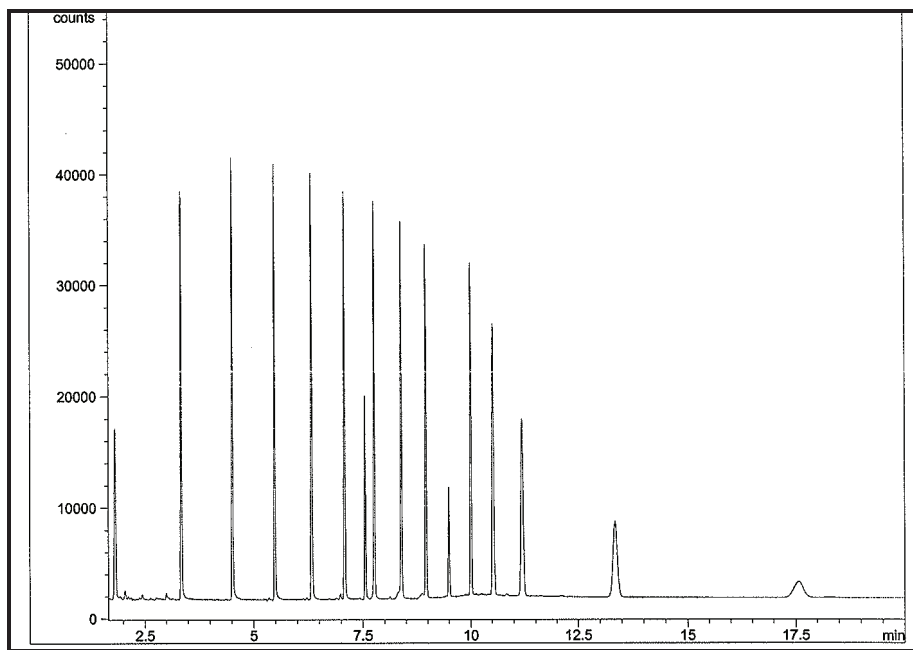

Chromatogram

Appendix B

Fuel Fluorescence Detector (FFD) Probe Analyses

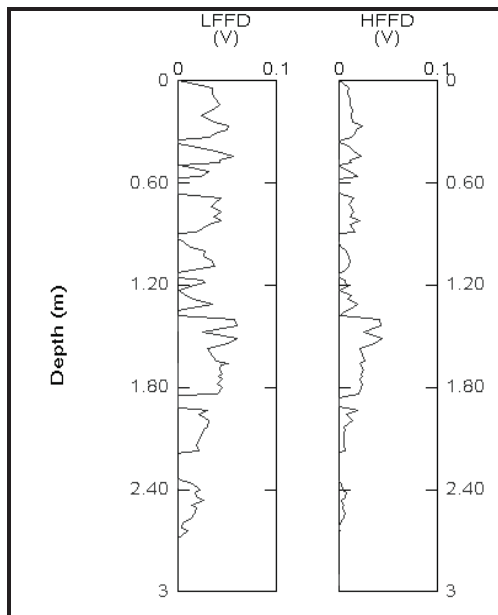

Figure 1: FFD probe analysis of BP-12.

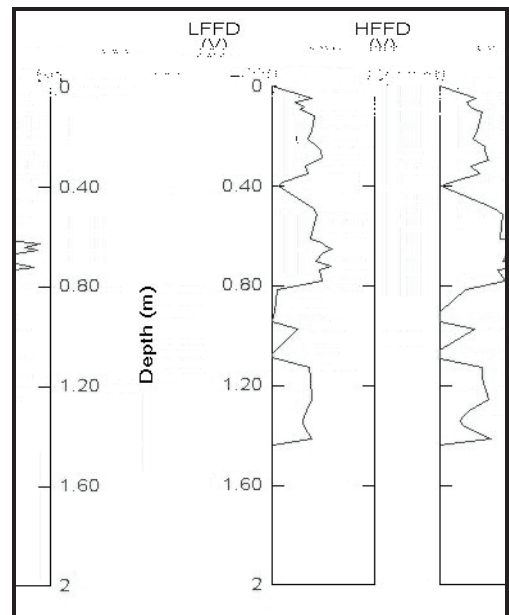

Figure 2: FFD probe analysis of BP-2.

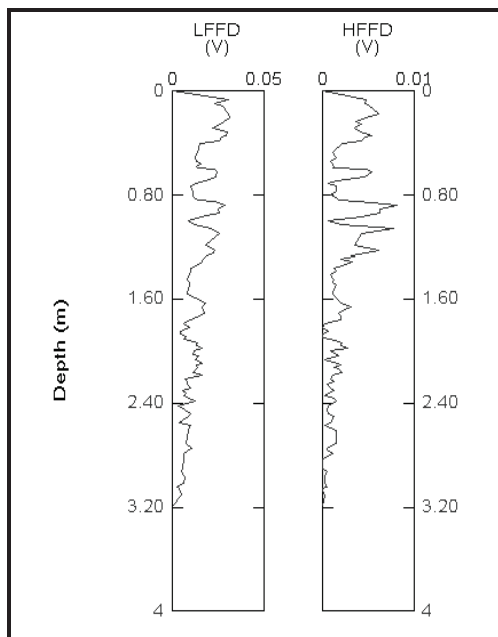

Figure 3: FFD probe analysis of BP-26.

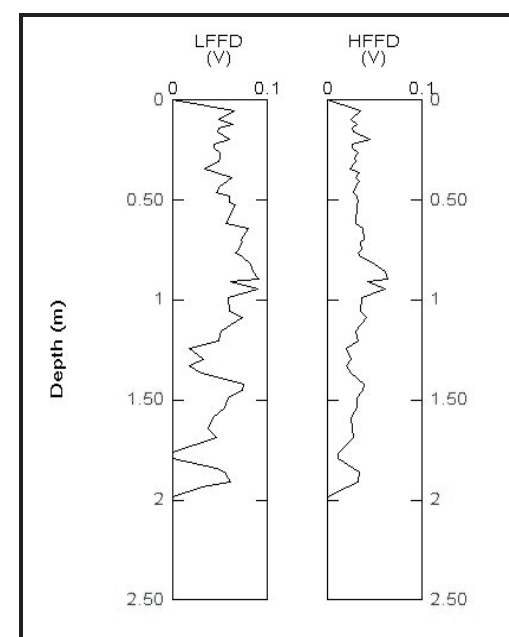

Figure 4: FFD probe analysis of BP-31.

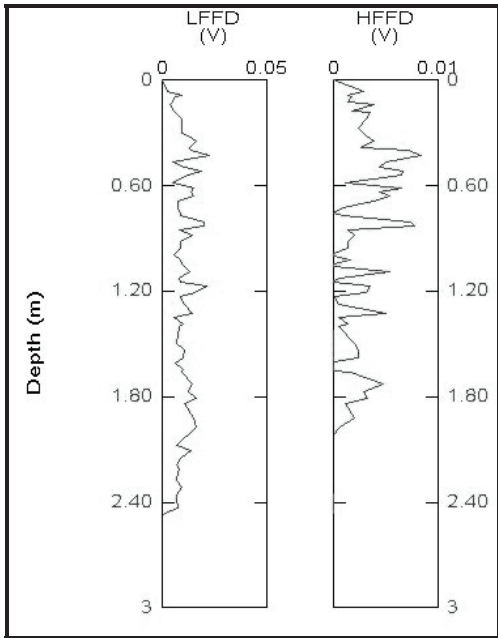

Figure 5: FFD probe analysis of BP-40.

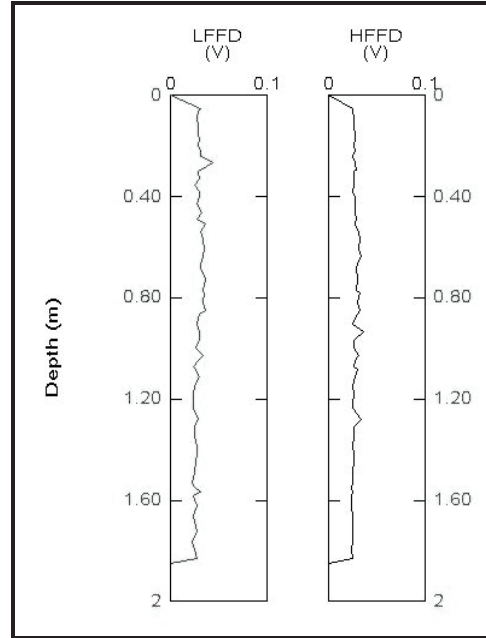

Figure 6: FFD probe analysis of BP-59.

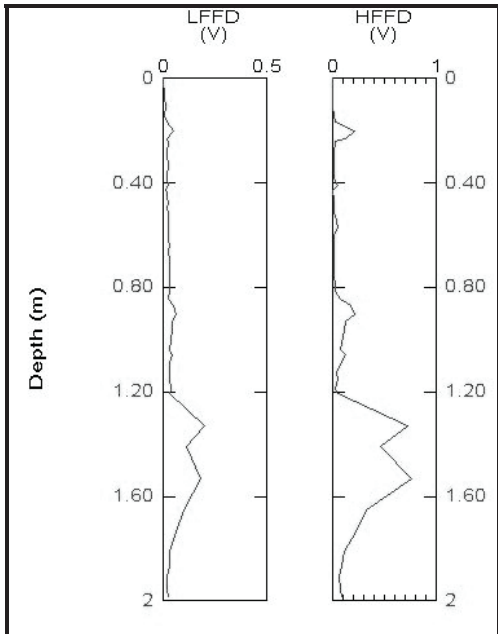

Figure 7: FFD probe analysis of BP-75.

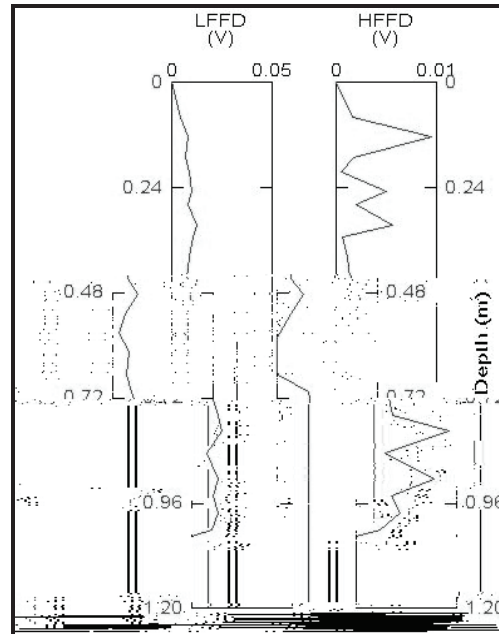

Figure 8: FFD probe analysis of BP-80.

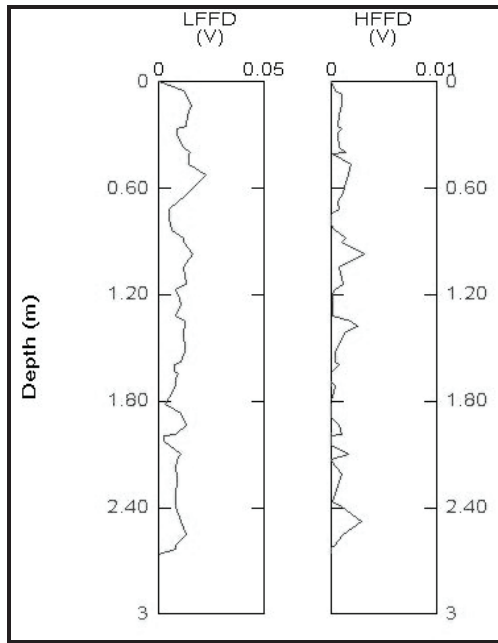

Figure 9: FFD probe analysis of BP-88.

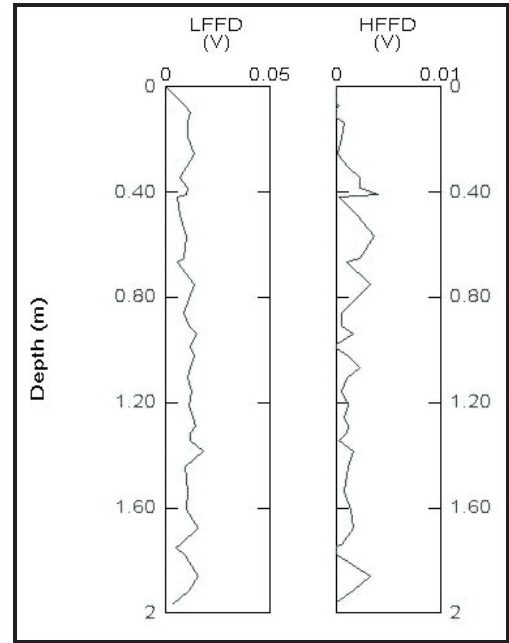

Figure 10: FFD probe analysis of BP-91.

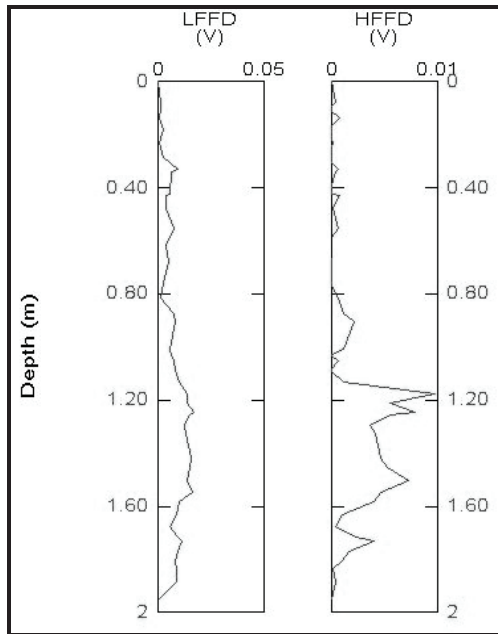

Figure 11: FFD probe analysis of BP-94.

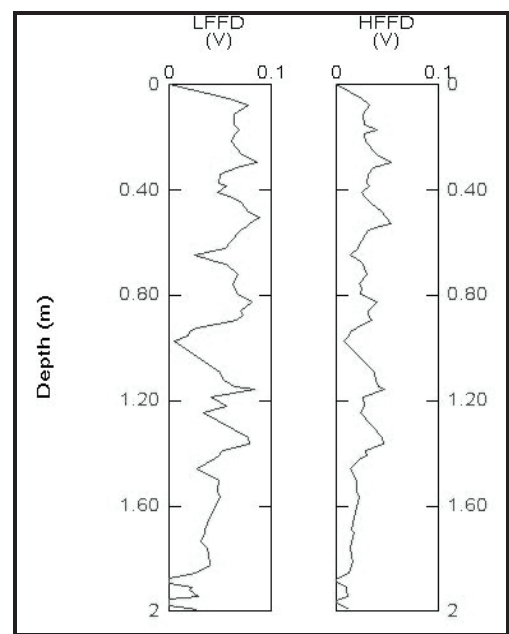

Figure 12: FFD probe analysis of BP-18.

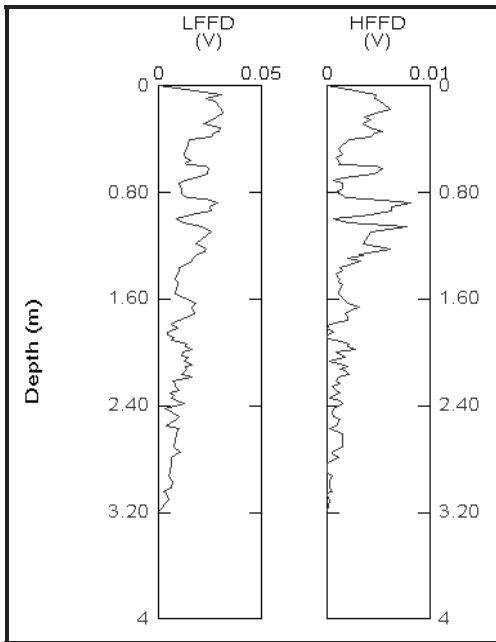

Figure 13: FFD probe analysis of BP-24.

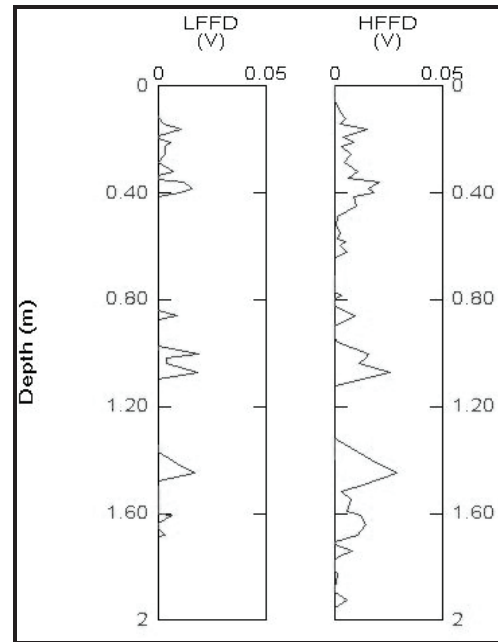

Figure 14: FFD probe analysis of BP-3.

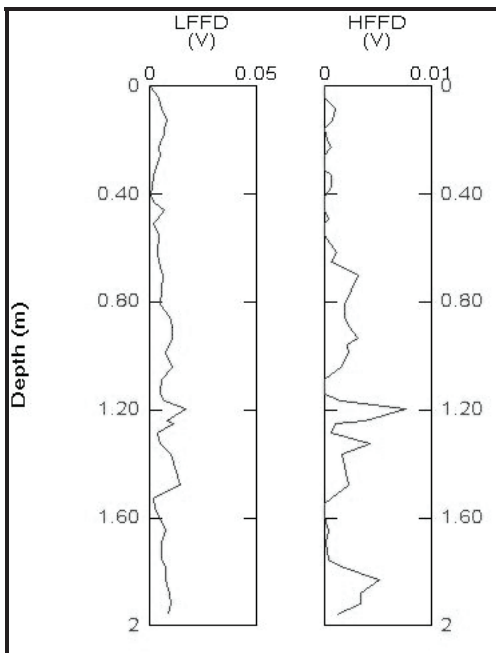

Figure 15: FFD probe analysis of BP-39.

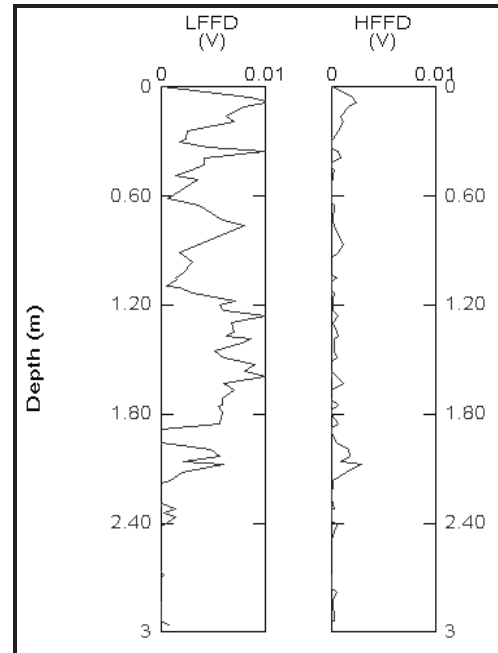

Figure 16: FFD probe analysis of BP-51.

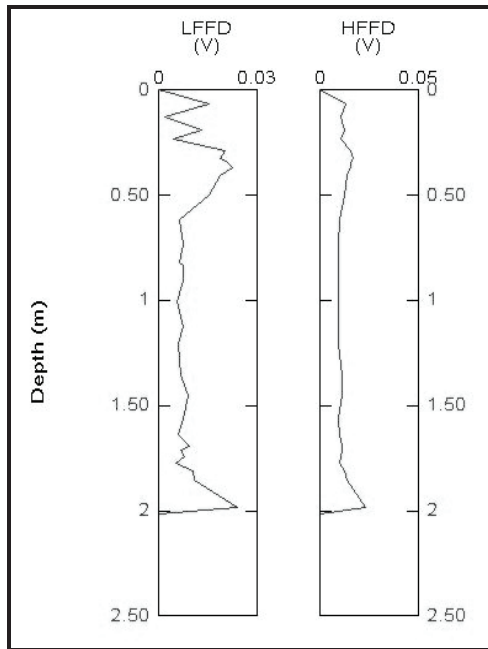

Figure 17: FFD probe analysis of BP-70.

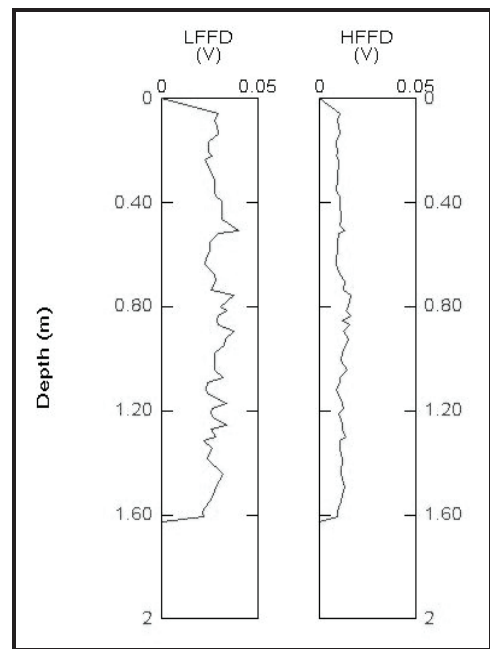

Figure 18: FFD probe analysis of BP-76.

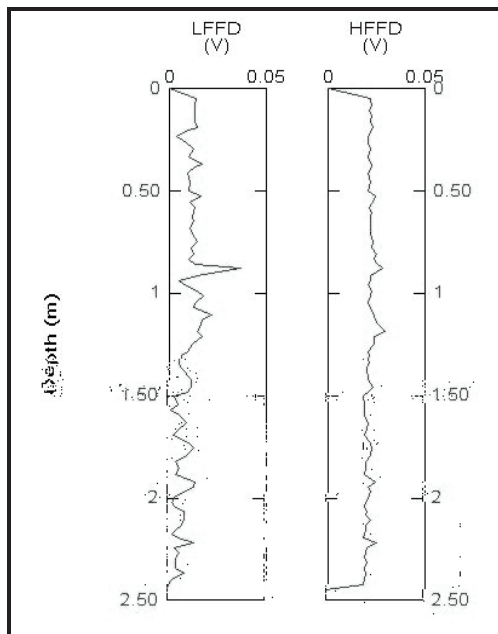

Figure 19: FFD probe analysis of BP-82.

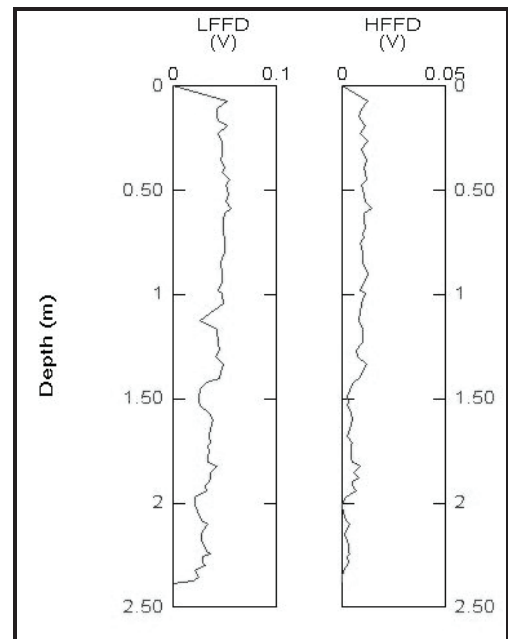

Figure 20: FFD probe analysis of BP-90.

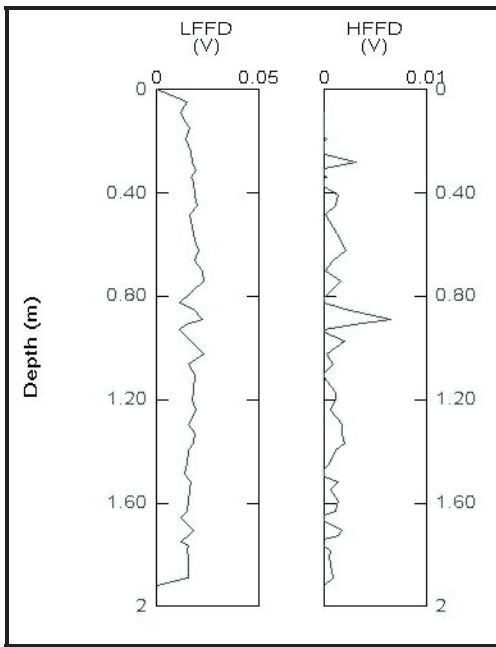

Figure 21: FFD probe analysis of BP-93.

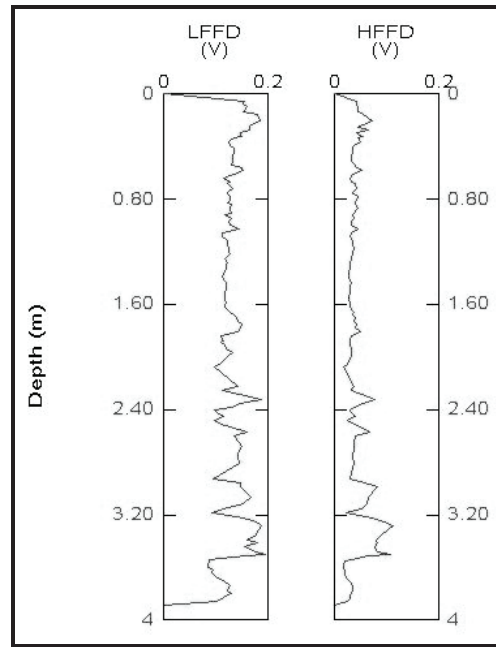

Figure 22: FFD probe analysis of BP-45.

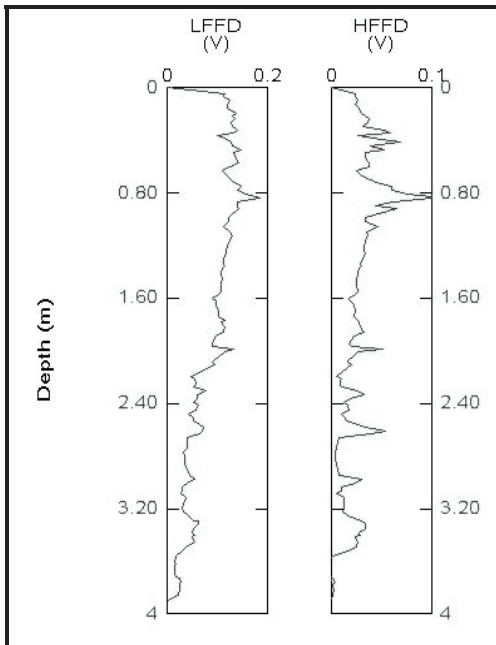

Figure 23: FFD probe analysis of BP-68.

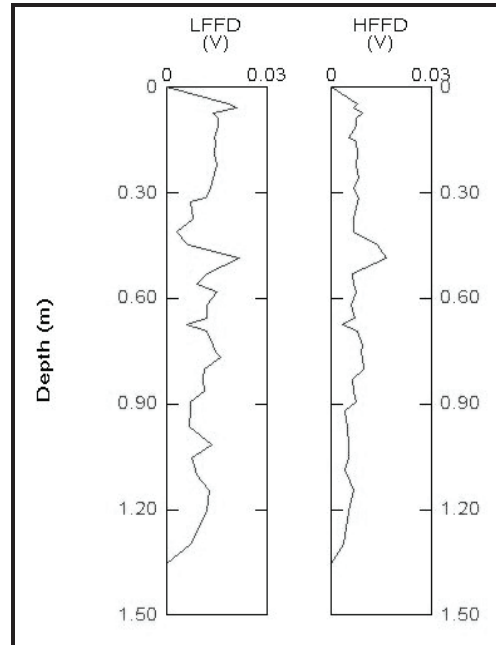

Figure 24: FFD probe analysis of BP-25.

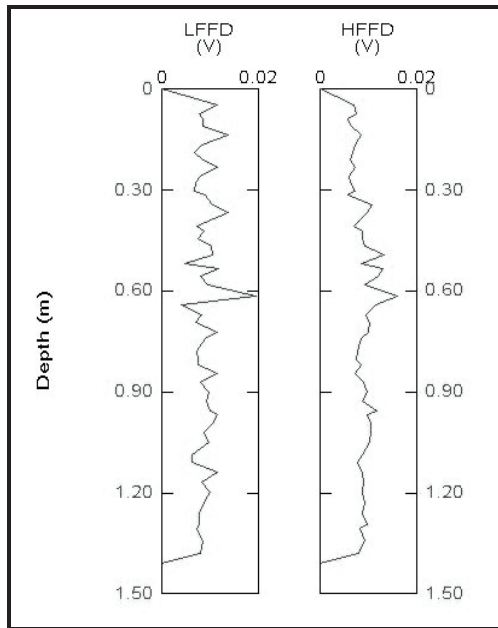

Figure 25: FFD probe analysis of BP-6.

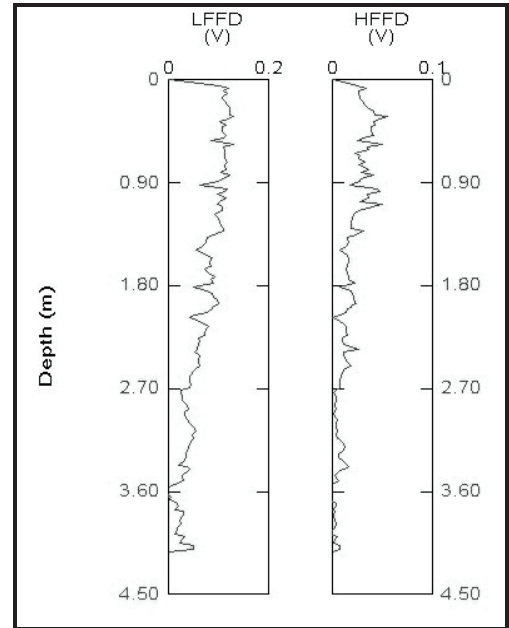

Figure 26: FFD probe analysis of BP-23.

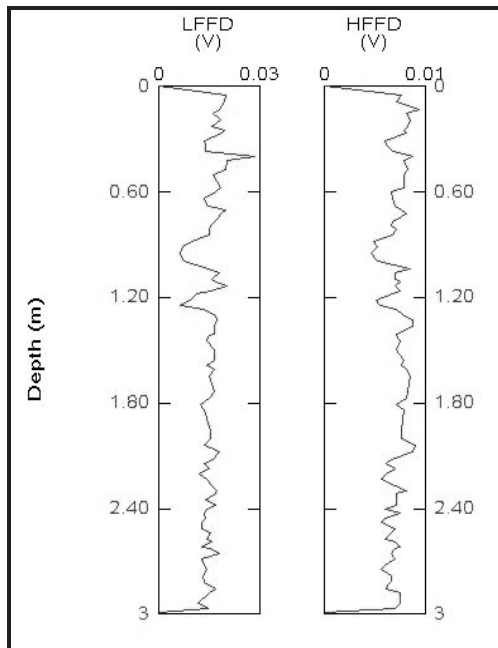

Figure 27: FFD probe analysis of BP-47.

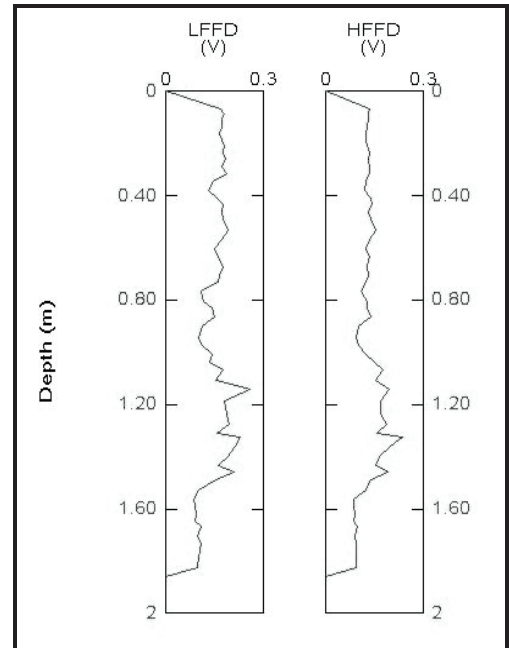

Figure 28: FFD probe analysis of BP-4.

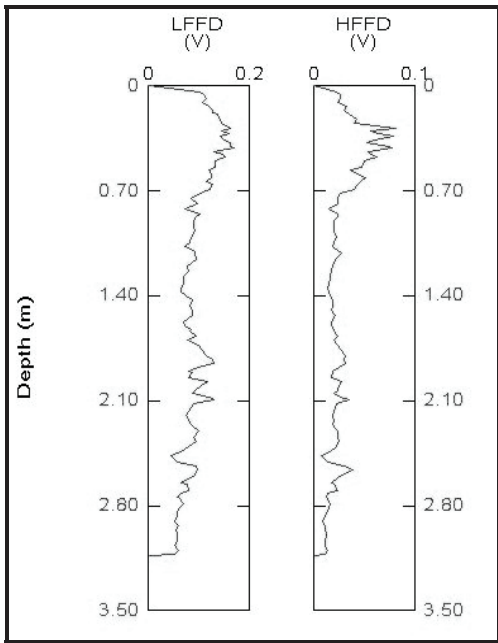

Figure 29: FFD probe analysis of BP-44.

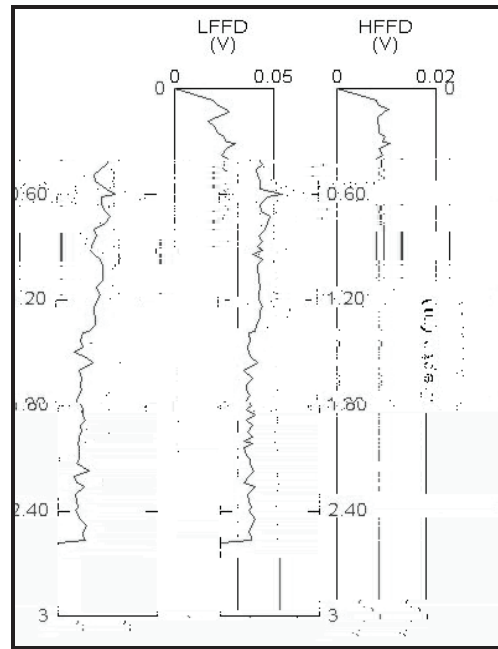

Figure 30: FFD probe analysis of BP-55.

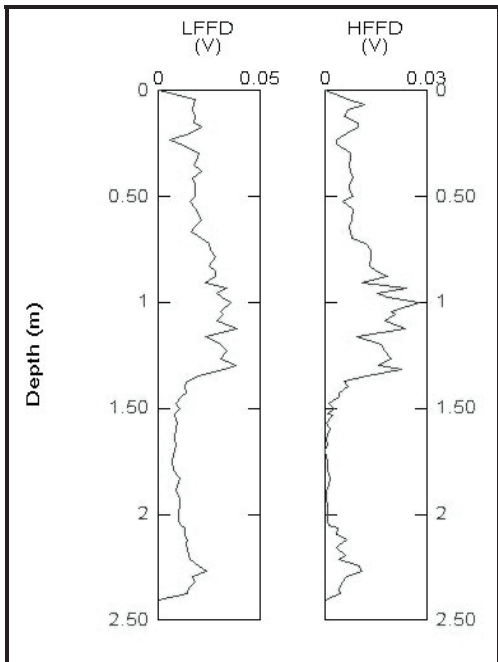

Figure 31: FFD probe analysis of BP-71.

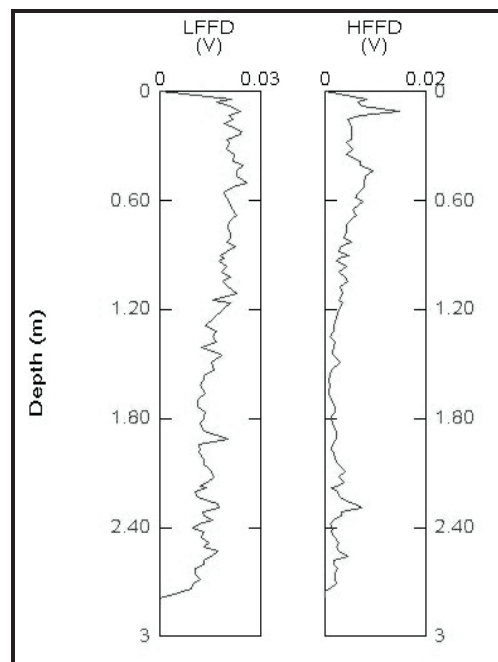

Figure 32: FFD probe analysis of BP-46.

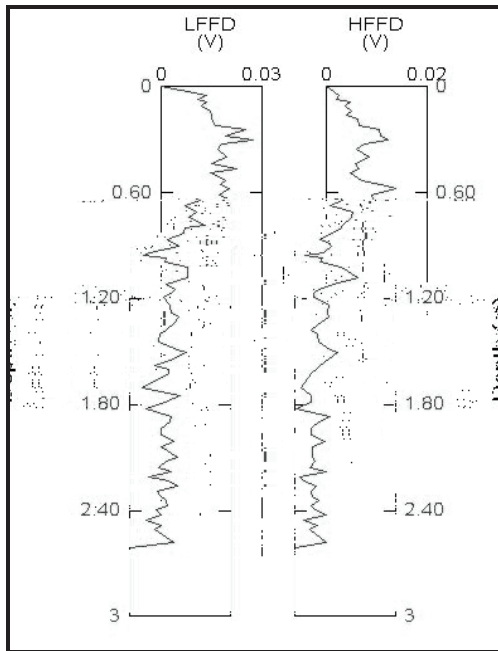

Figure 33: FFD probe analysis of BP-38.

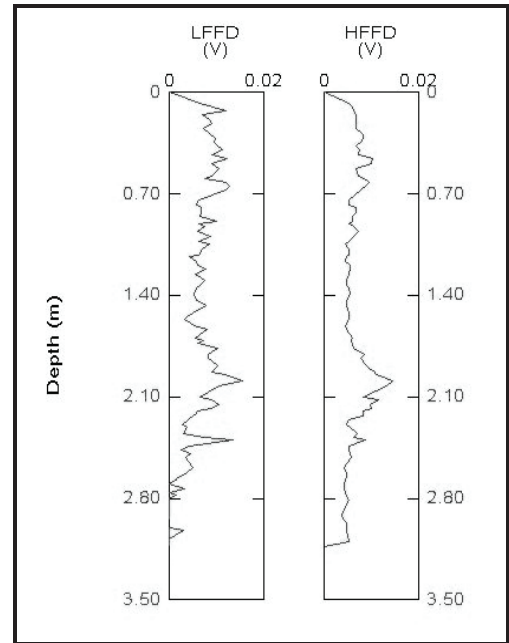

Figure 34: FFD probe analysis of BP-36.

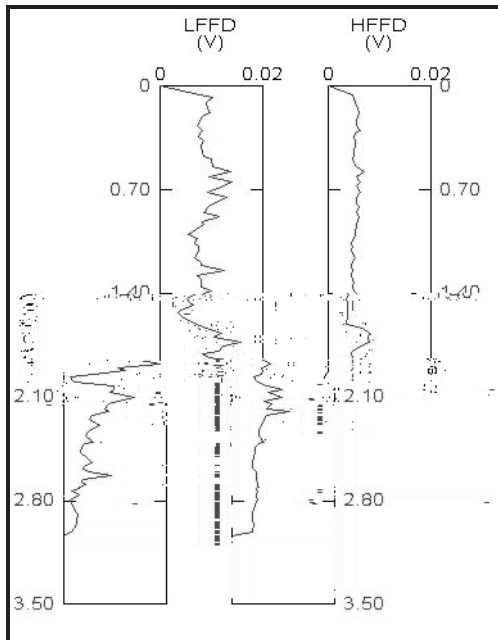

Figure 35: FFD probe analysis of BP-35.

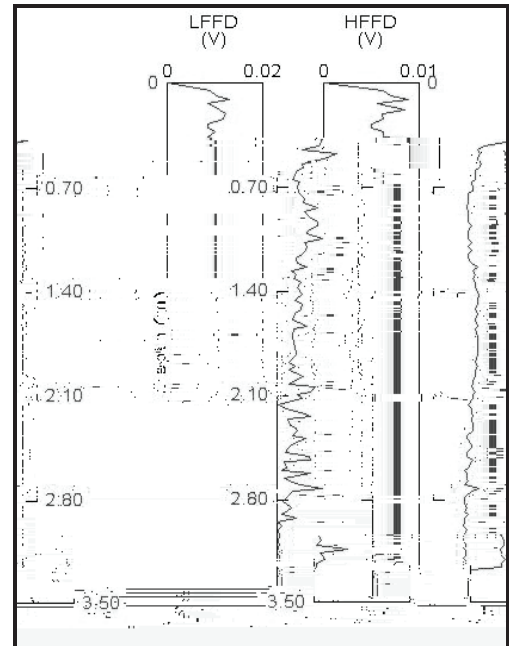

Figure 36: FFD probe analysis of BP-34.

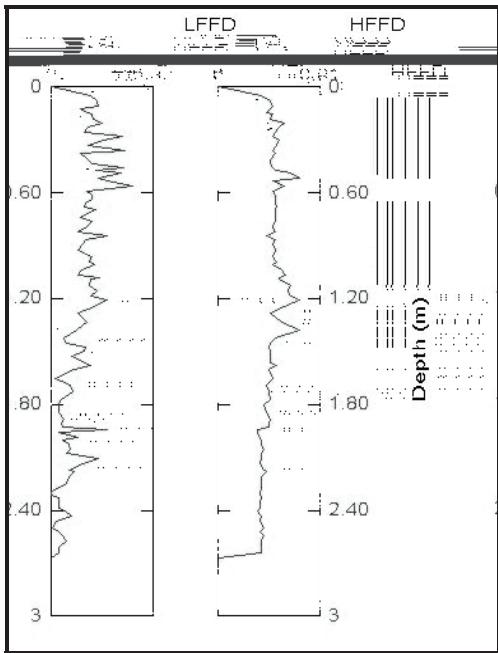

Figure 37: FFD probe analysis of BP-22.

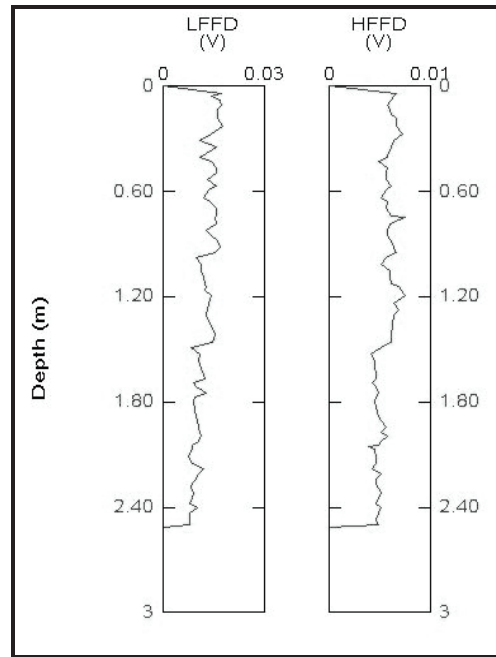

Figure 38: FFD probe analysis of BP-15.

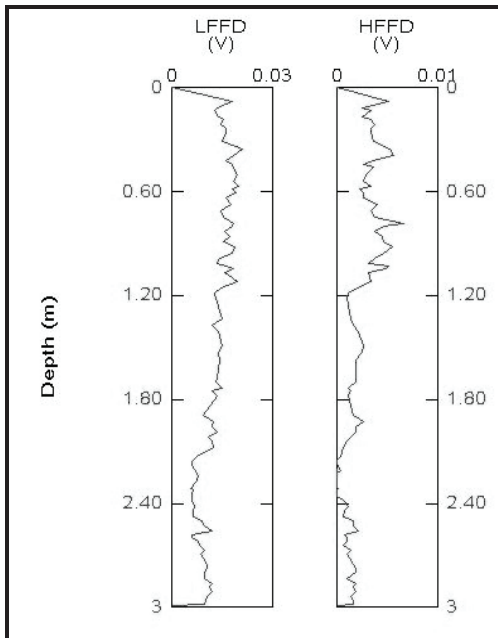

Figure 39: FFD probe analysis of BP-21.

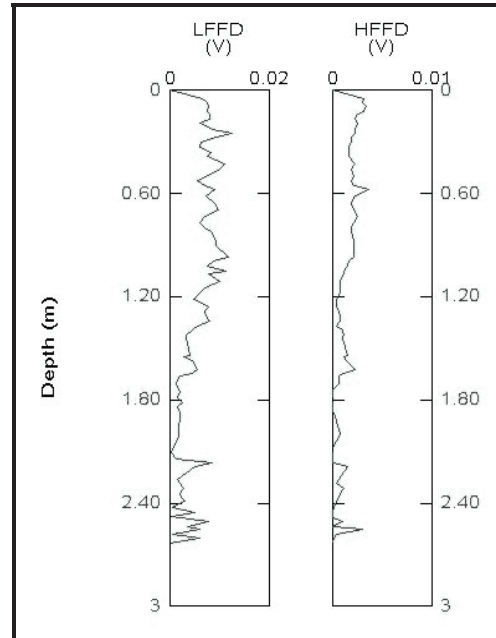

Figure 40: FFD probe analysis of BP-33.

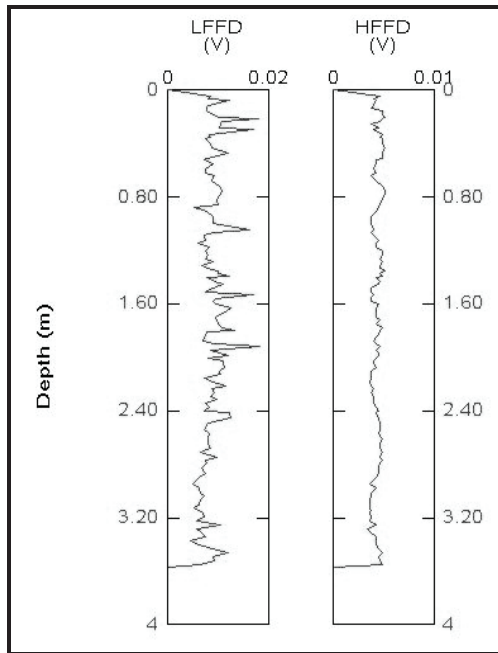

Figure 41: FFD probe analysis of BP-20.

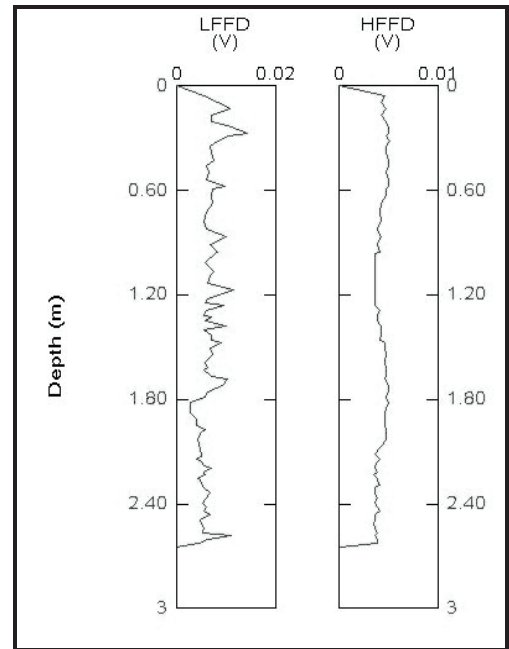

Figure 42: FFD probe analysis of BP-14.

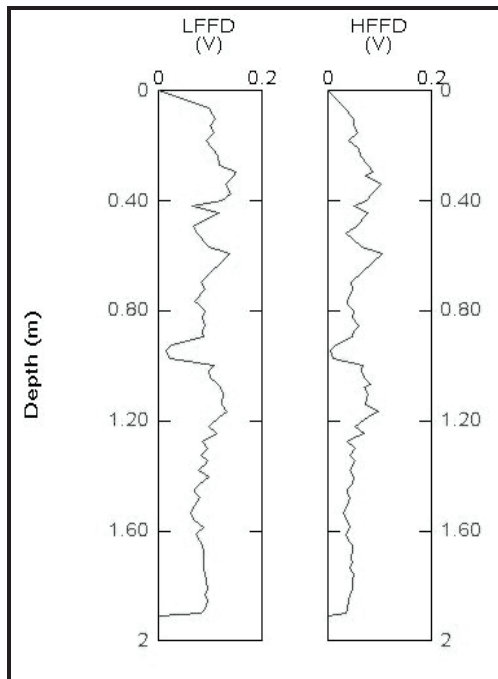

Figure 43: FFD probe analysis of BP-11.

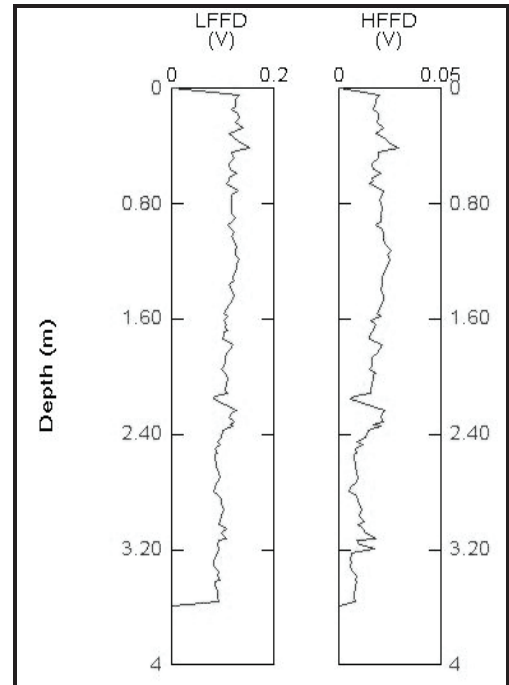

Figure 44: FFD probe analysis of BP-5.

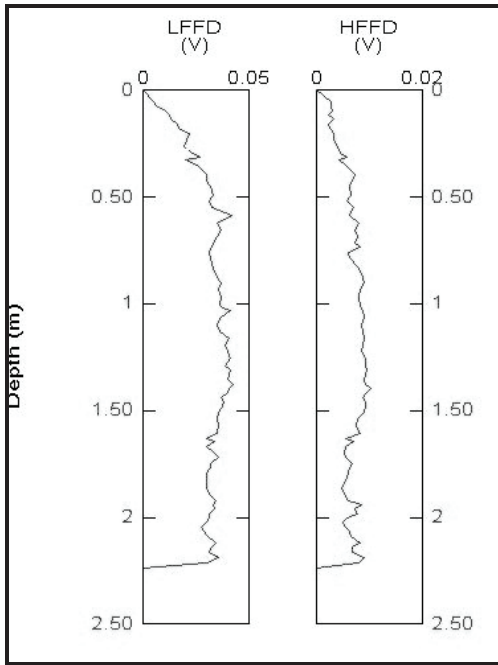

Figure 45: FFD probe analysis of BP-56.

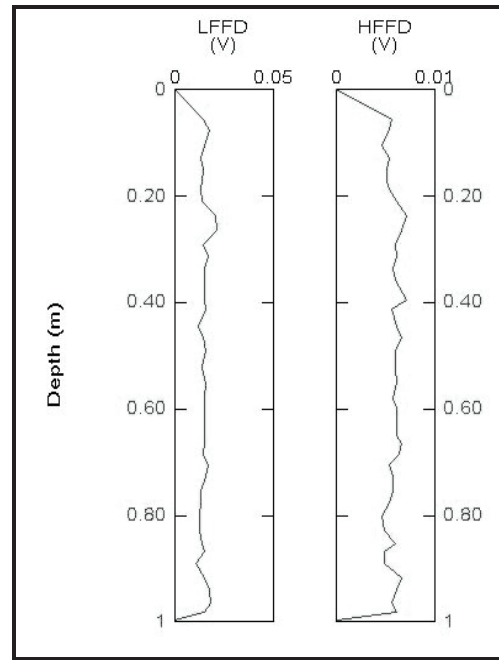

Figure 46: FFD probe analysis of BP-10.

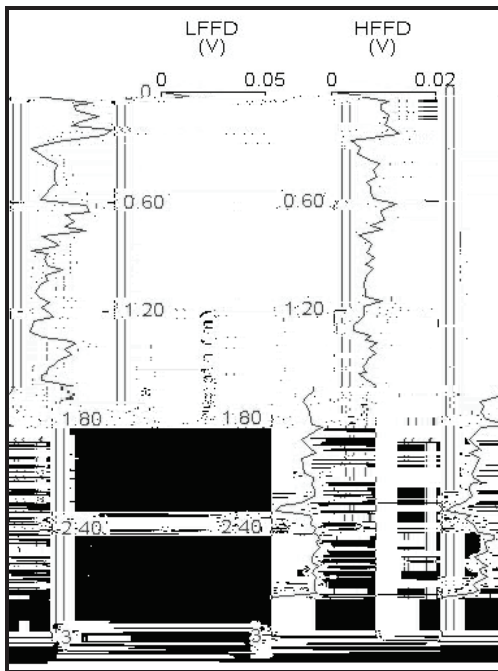

Figure 47: FFD probe analysis of BP-42.

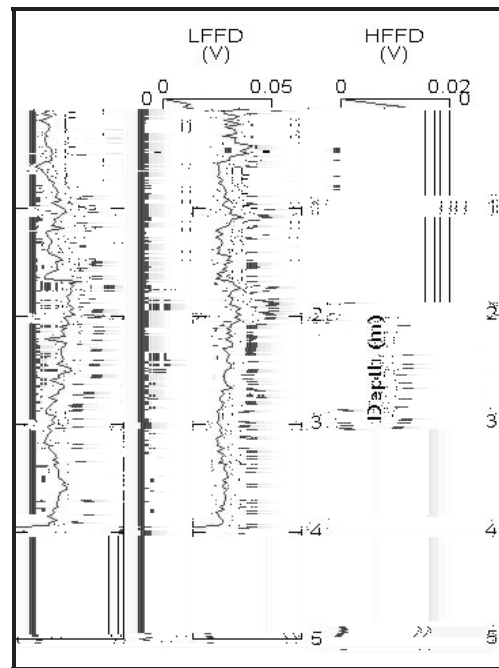

Figure 48: FFD probe analysis of BP-29.

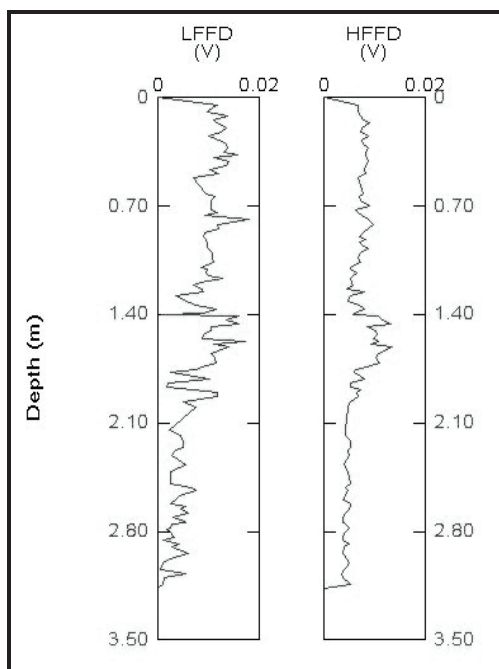

Figure 49: FFD probe analysis of BP-30.

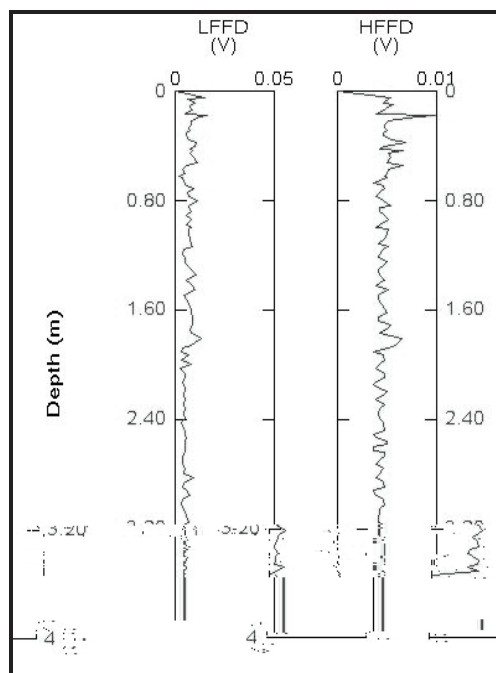

Figure 50: FFD probe analysis of BP-64.

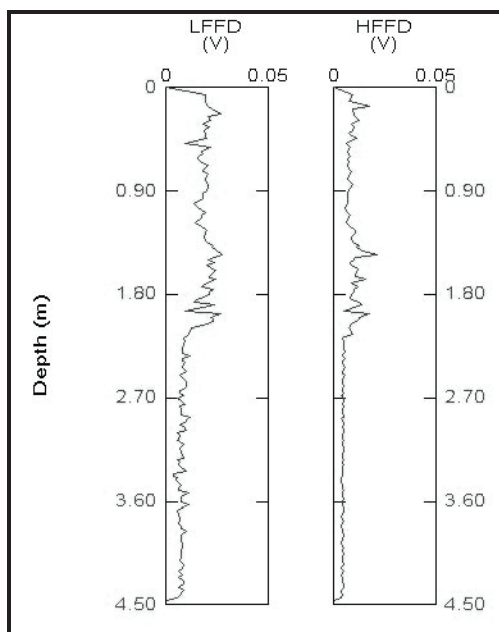

Figure 51: FFD probe analysis of BP-98.

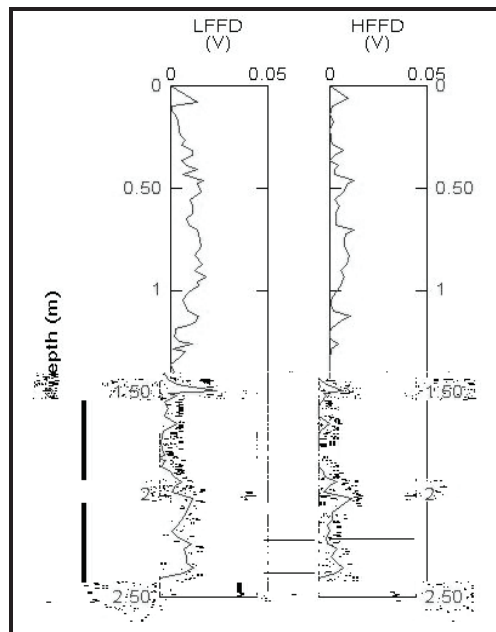

Figure 52: FFD probe analysis of BP-37.

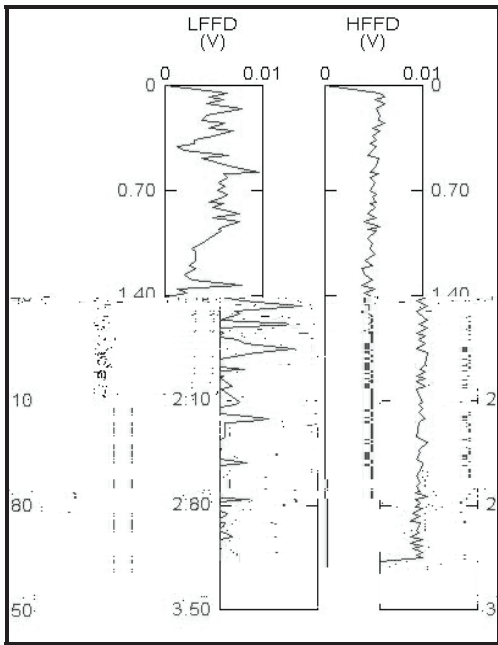

Figure 53: FFD probe analysis of BP-54.

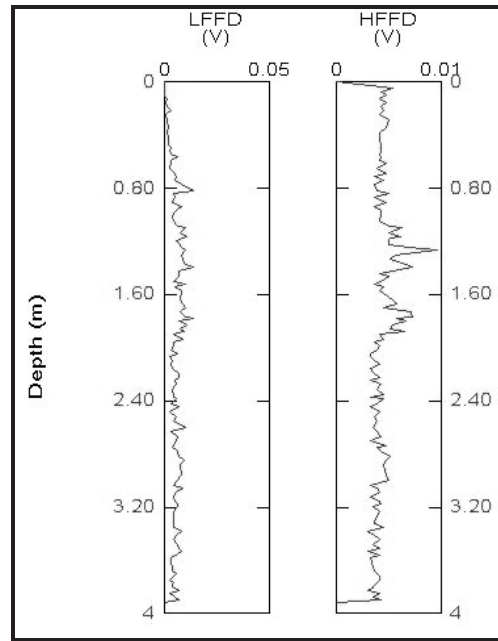

Figure 54: FFD probe analysis of BP-32.

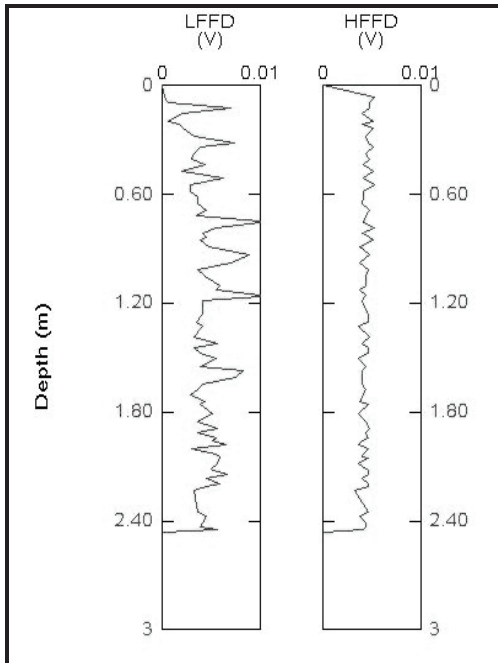

Figure 55: FFD probe analysis of BP-53.

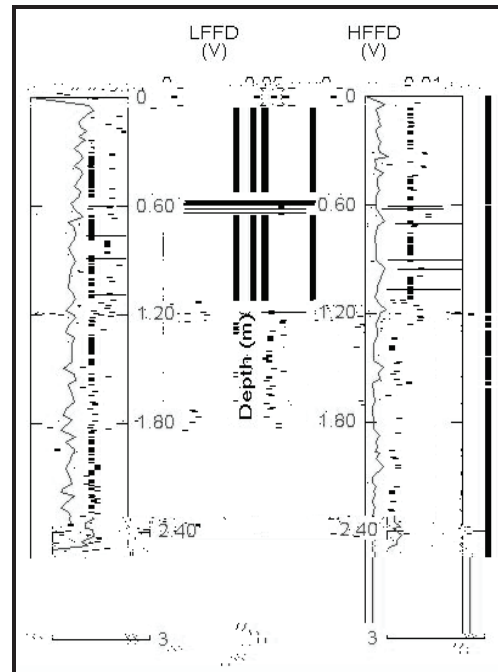

Figure 56: FFD probe analysis of BP-99.

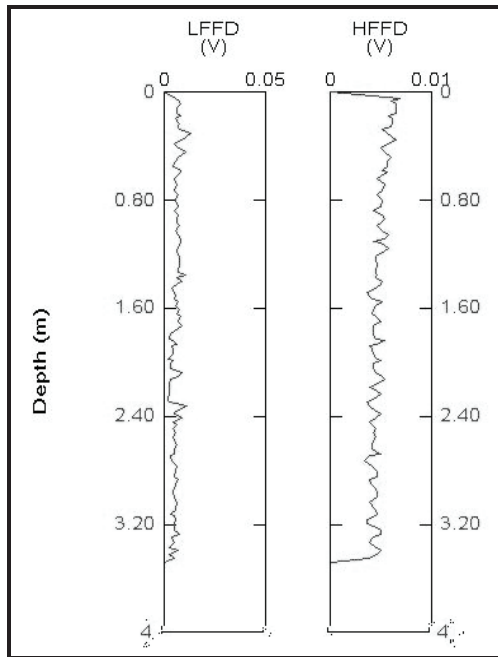

Figure 57: FFD probe analysis of BP-86.

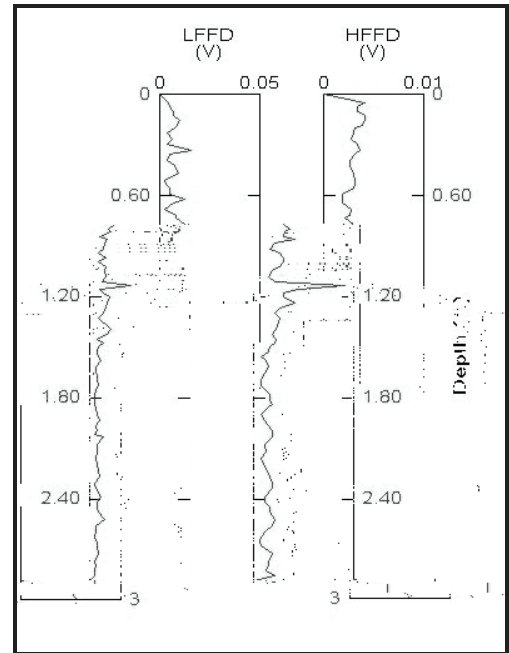

Figure 58: FFD probe analysis of BP-63.

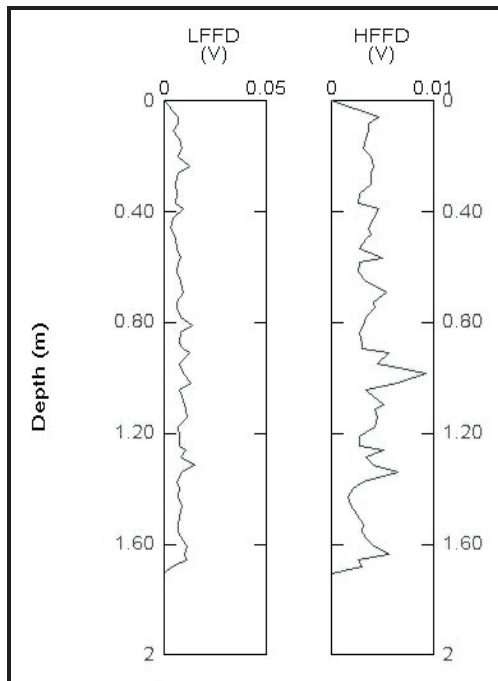

Figure 59: FFD probe analysis of BP-66.

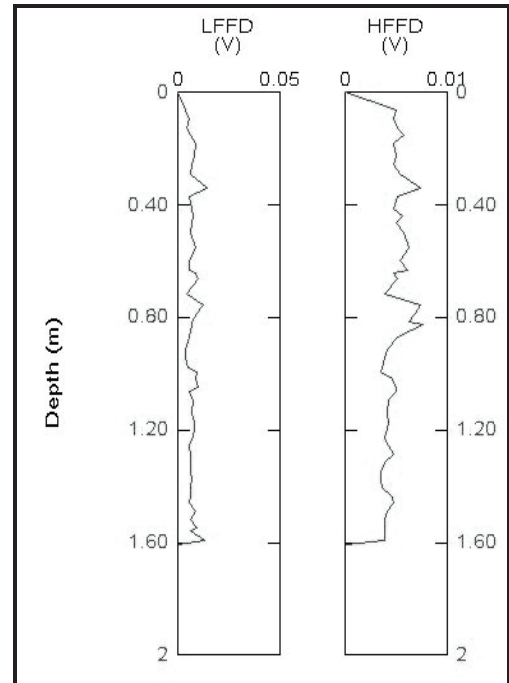

Figure 60: FFD probe analysis of BP-65.

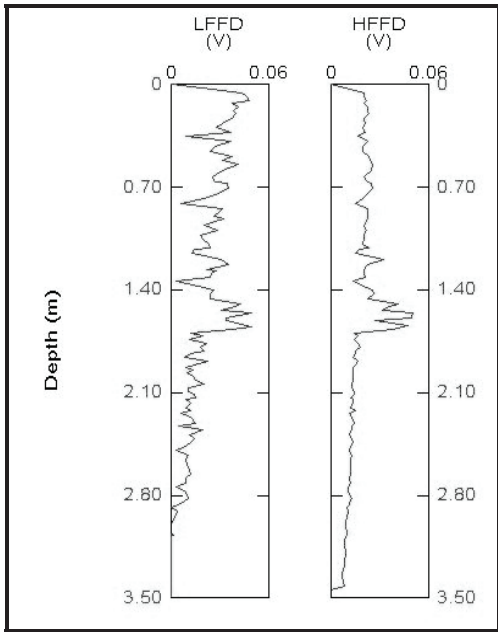

Figure 61: FFD probe analysis of BP-8.

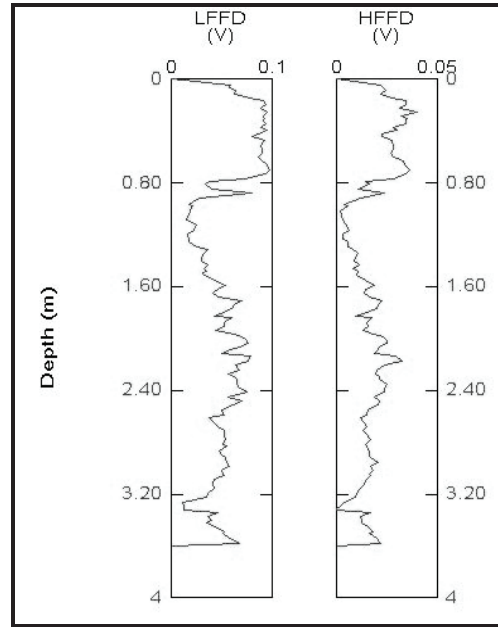

Figure 62: FFD probe analysis of BP-27.

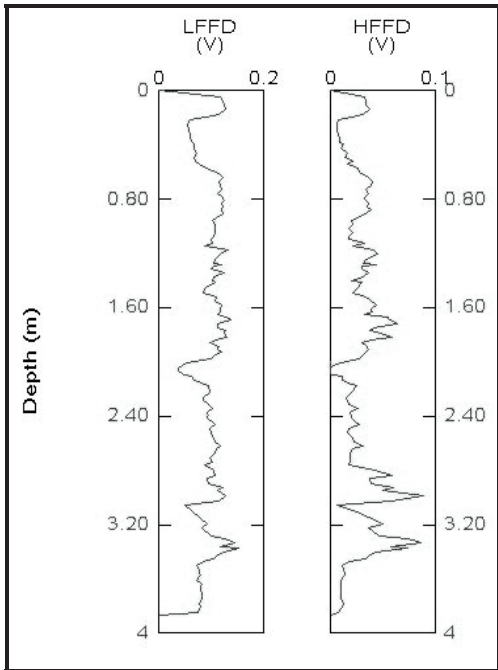

Figure 63: FFD probe analysis of BP-49.

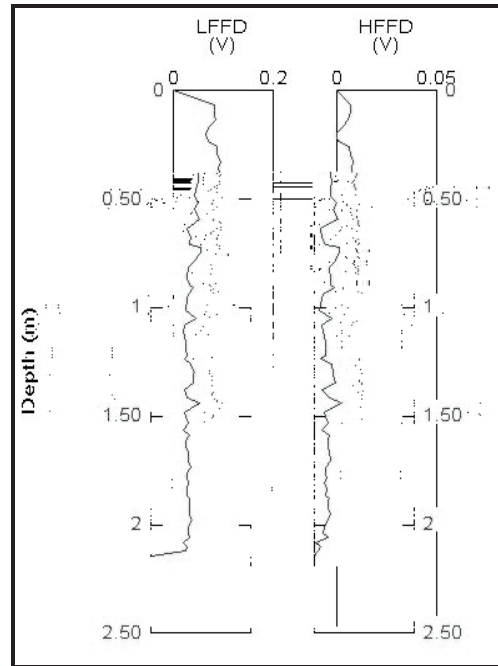

Figure 64: FFD probe analysis of BP-58.

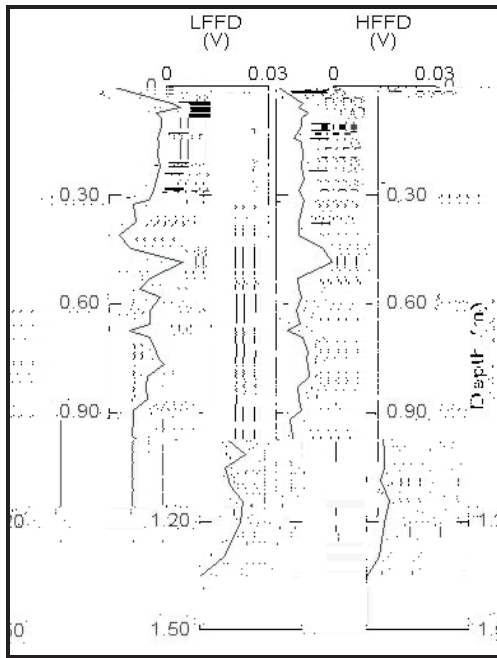

Figure 65: FFD probe analysis of BP-78.

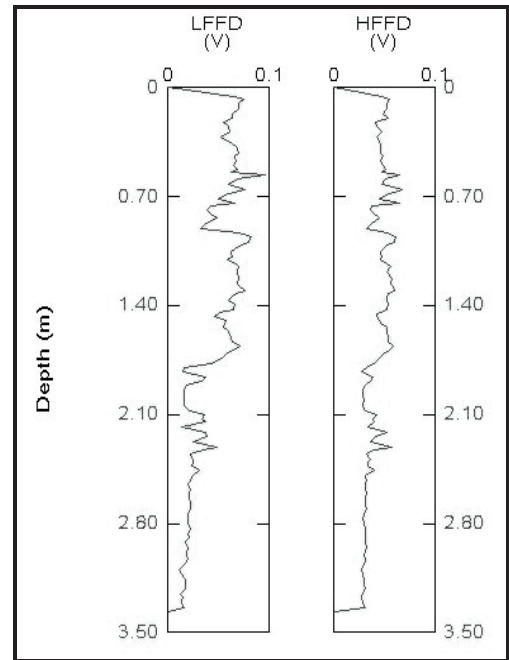

Figure 66: FFD probe analysis of BP-61.

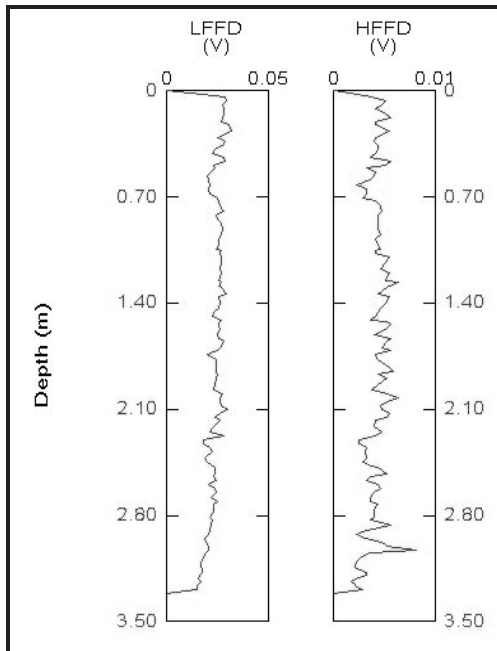

Figure 67: FFD probe analysis of BP-57.

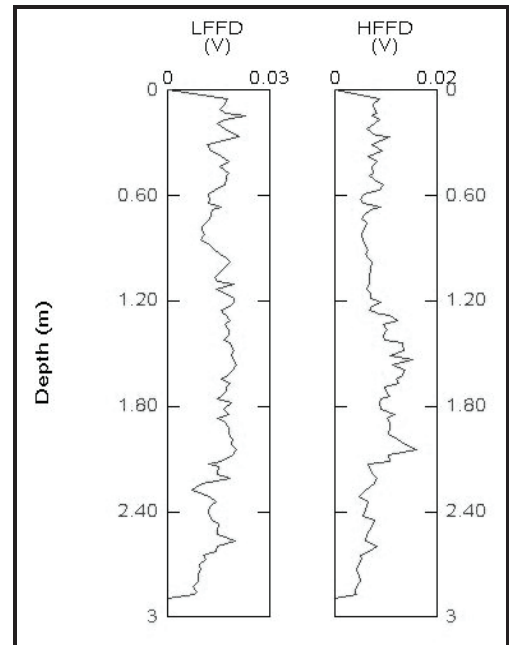
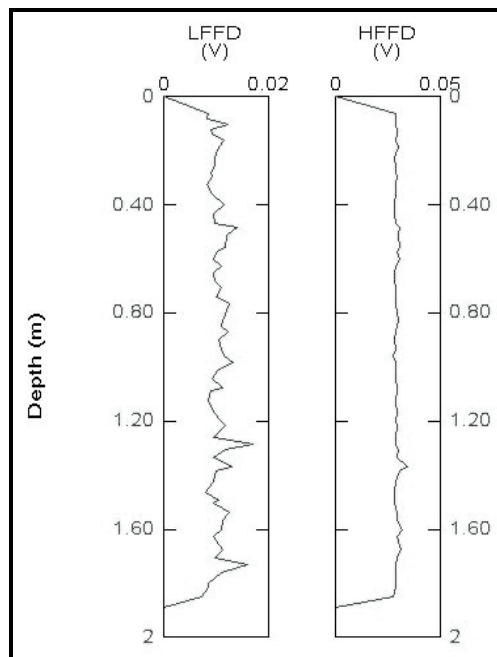
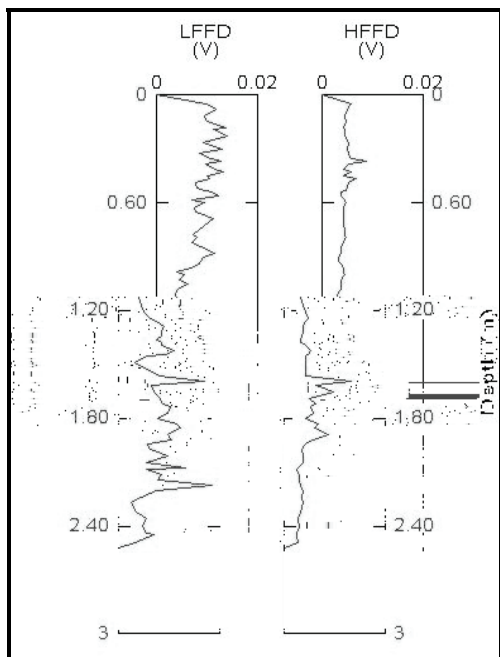
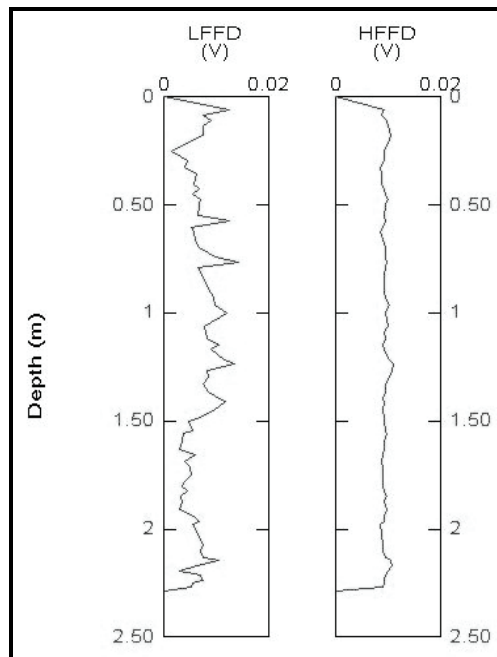
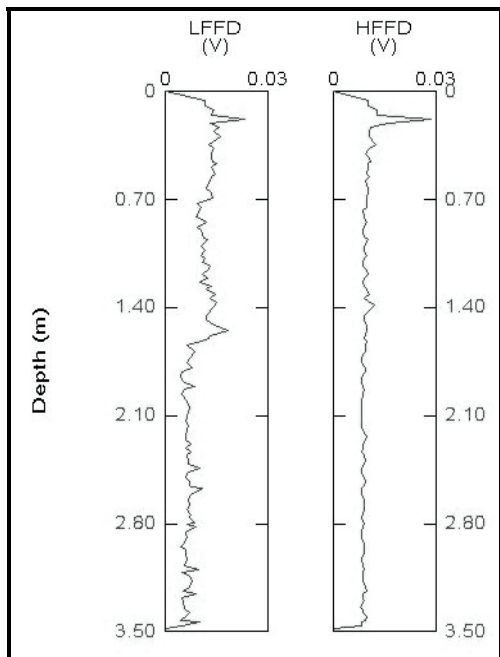

Figure 68: FFD probe analysis of BP-67.



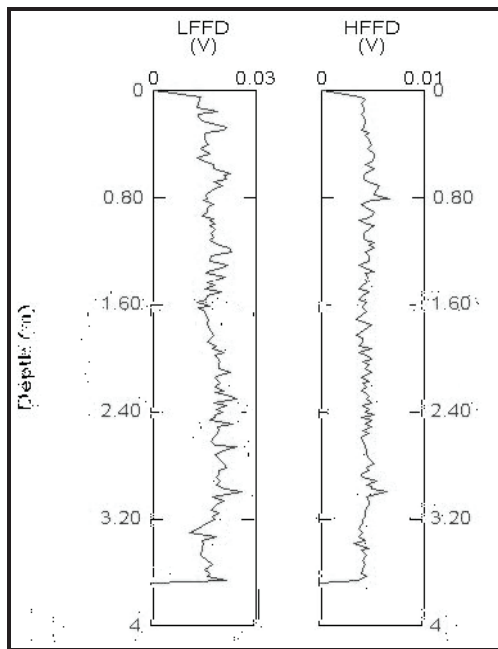

Figure 73: FFD probe analysis of BP-43.

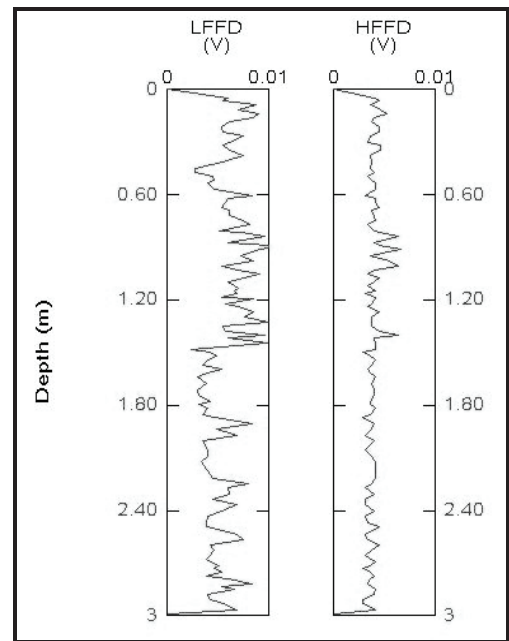

Figure 74: FFD probe analysis of BP-62.

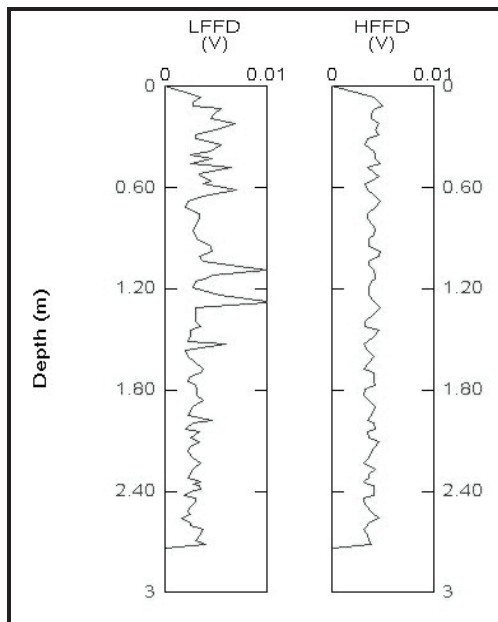

Figure 75: FFD probe analysis of BP-9.

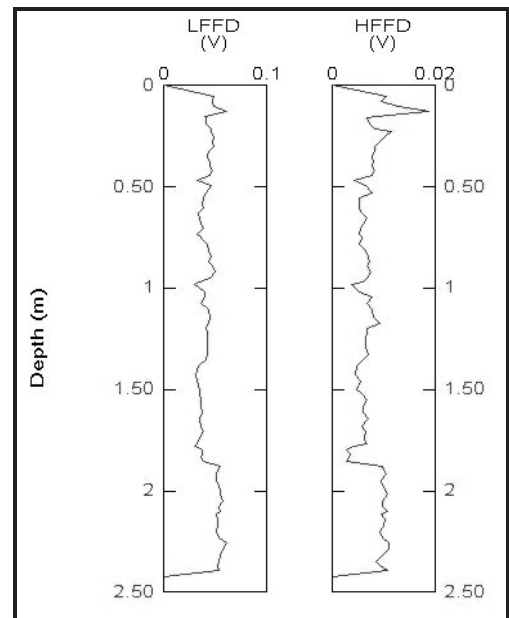

Figure 76: FFD probe analysis of BP-13.

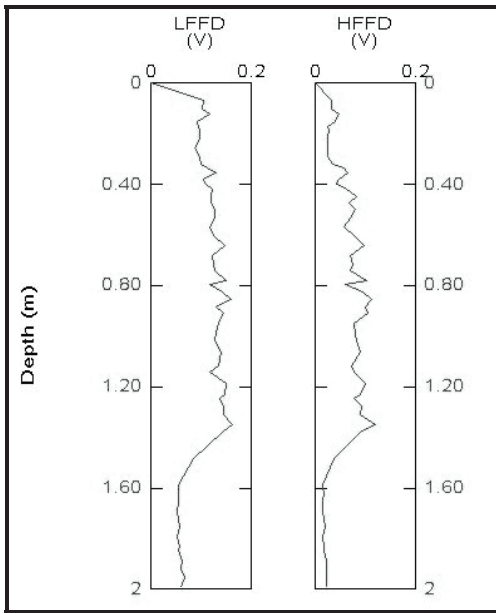

Figure 77: FFD probe analysis of BP-A.

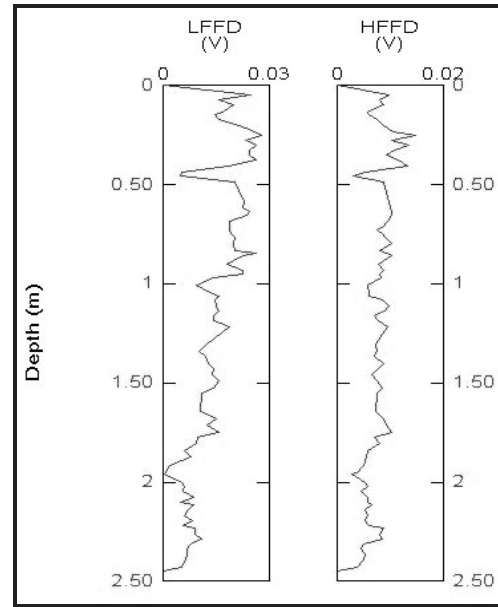

Figure 78: FFD probe analysis of BP-B.

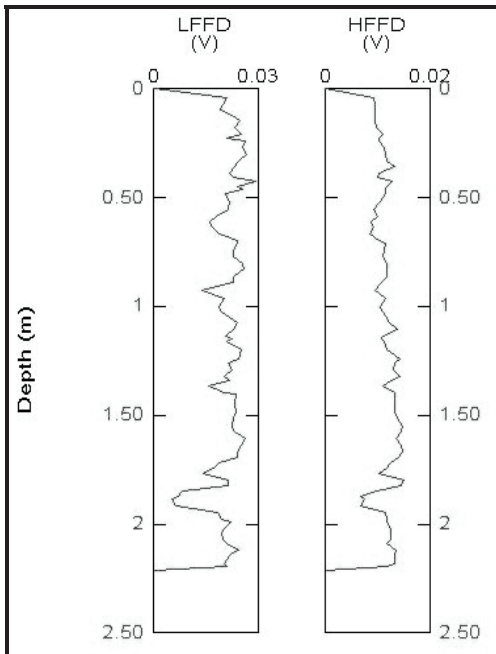

Figure 79: FFD probe analysis of BP-87.

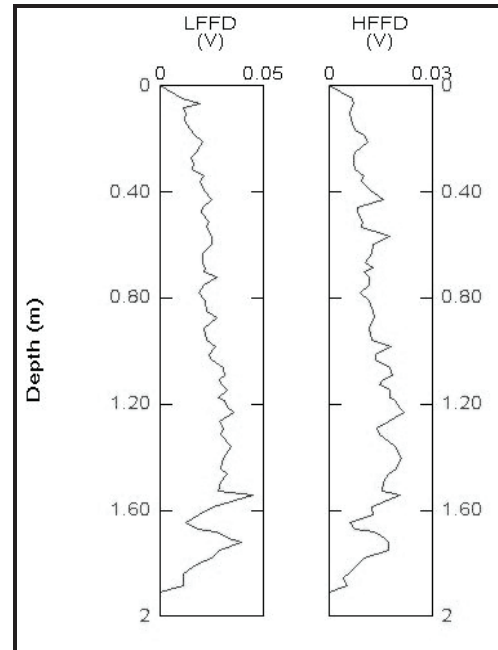

Figure 80: FFD probe analysis of BP-1.

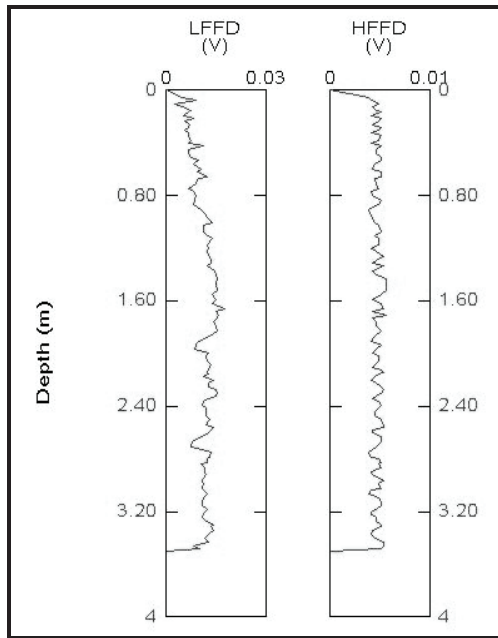

Figure 81: FFD probe analysis of BP-7.

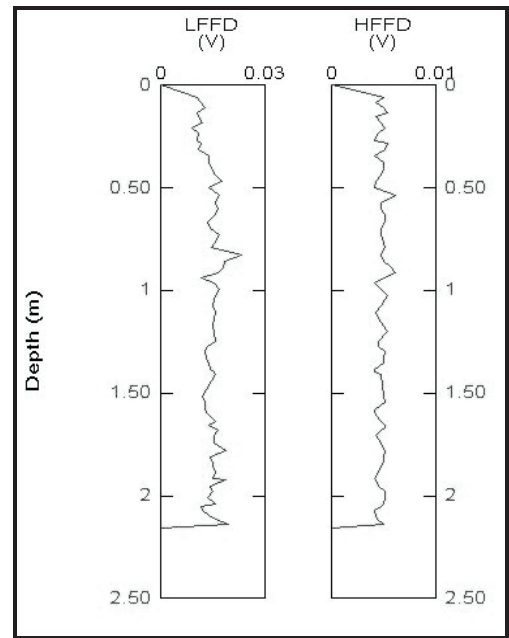

Figure 82: FFD probe analysis of BP-92.

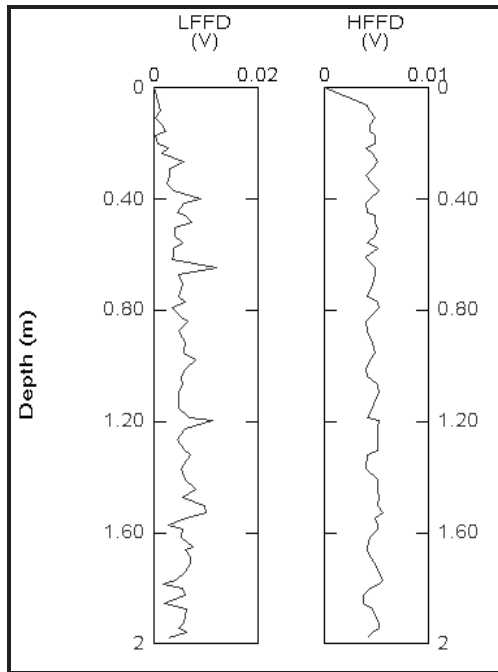

Figure 83: FFD probe analysis of BP-52.

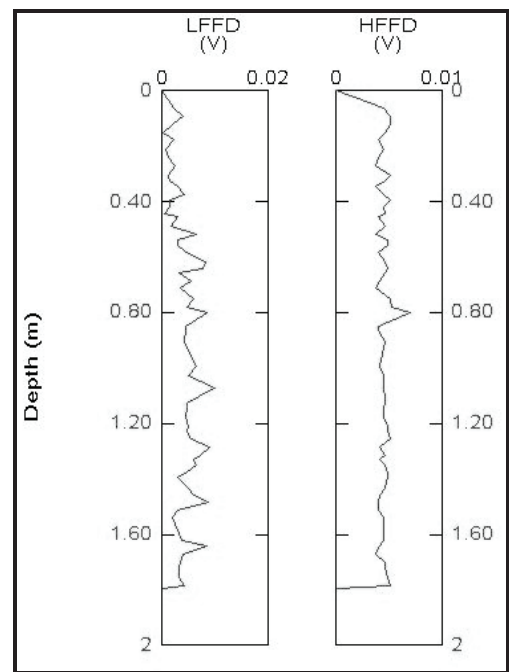

Figure 84: FFD probe analysis of BP-77.

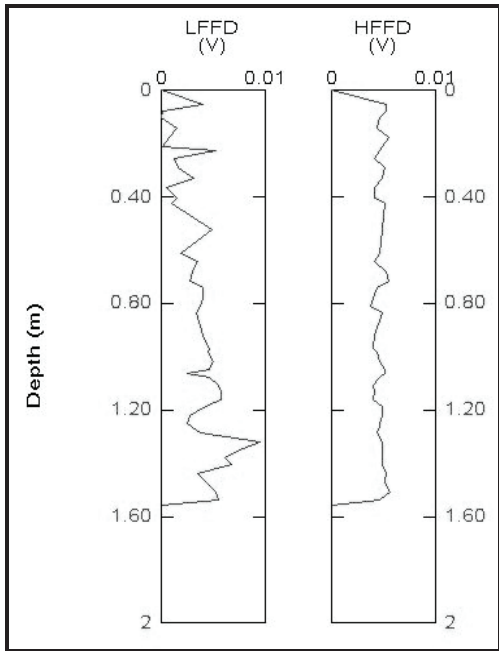

Figure 85: FFD probe analysis of BP-72.

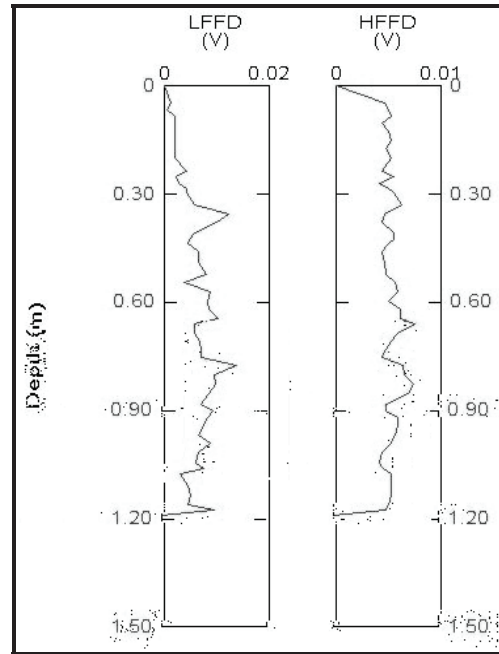

Figure 86: FFD probe analysis of BP-74.

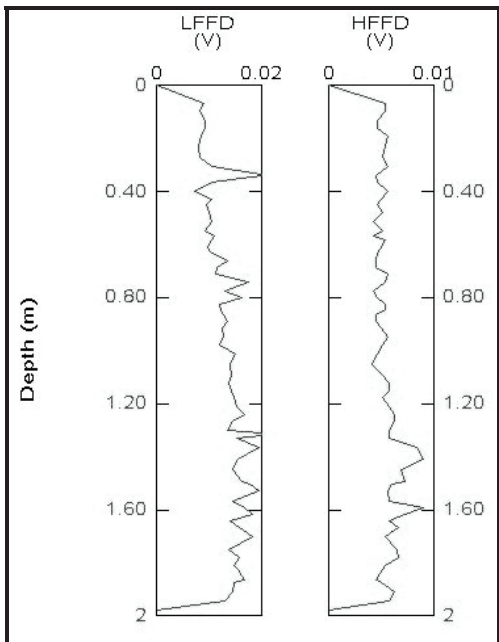

Figure 87: FFD probe analysis of BP-73.

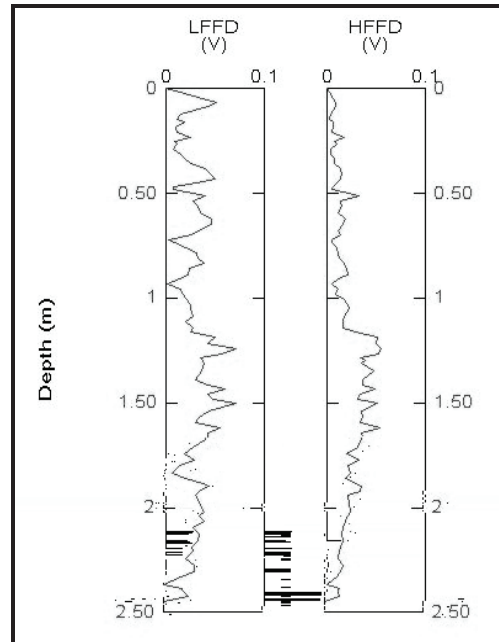

Figure 88: FFD probe analysis of BP-16.

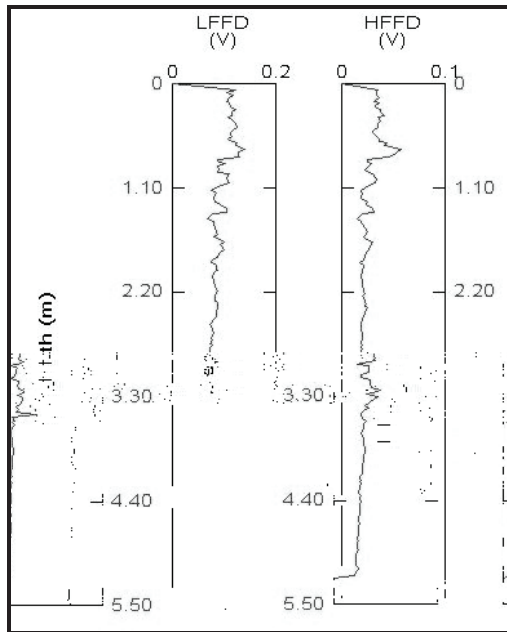

Figure 89: FFD probe analysis of BP-19.

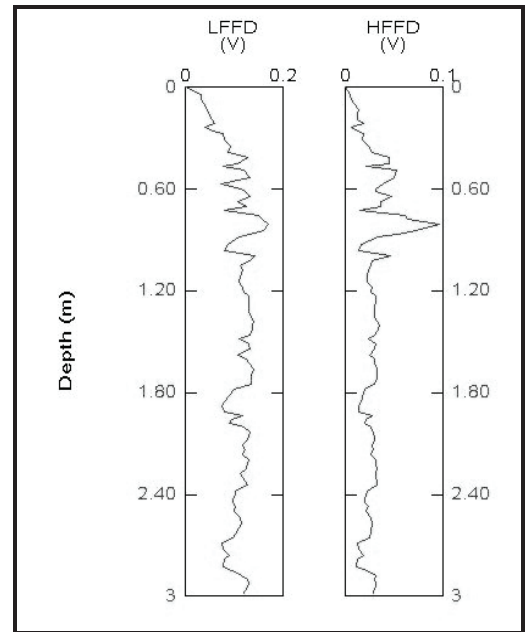

Figure 90: FFD probe analysis of BP-28.

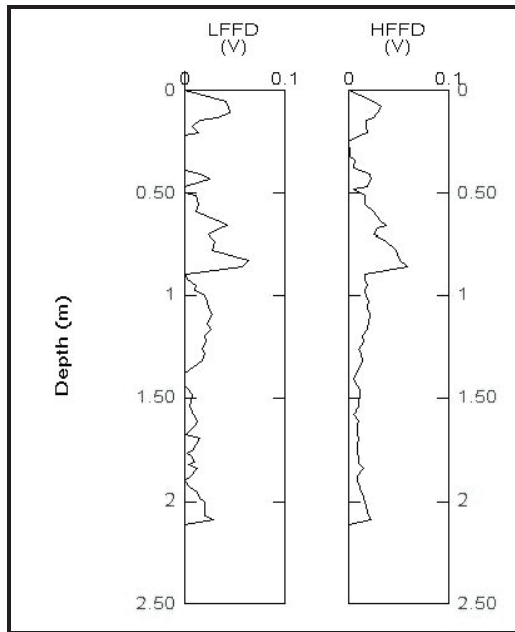

Figure 91: FFD probe analysis of BP-50.

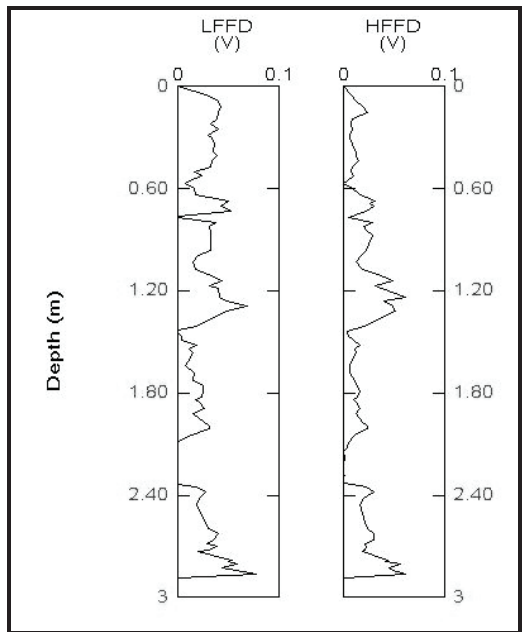

Figure 92: FFD probe analysis of BP-89.

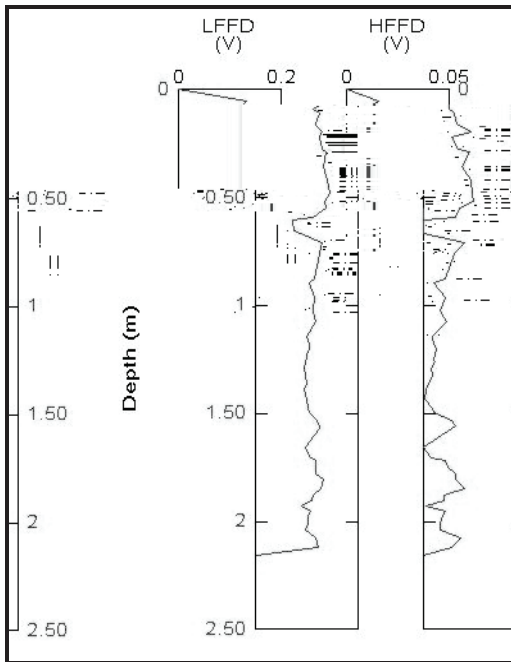

Figure 93: FFD probe analysis of BP-95.

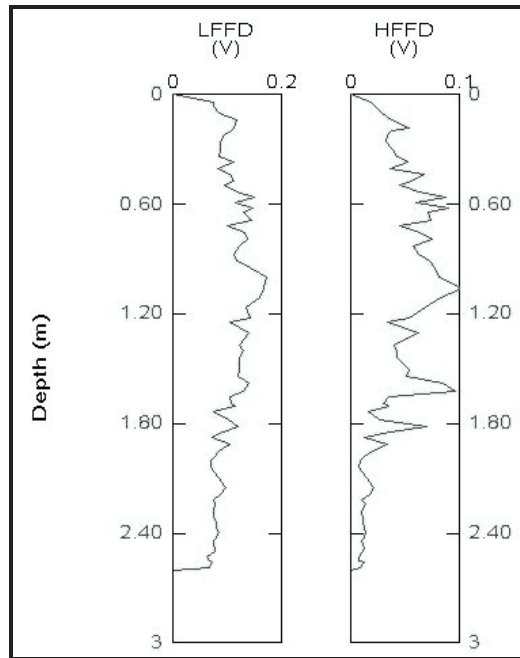

Figure 94: FFD probe analysis of BP-79.

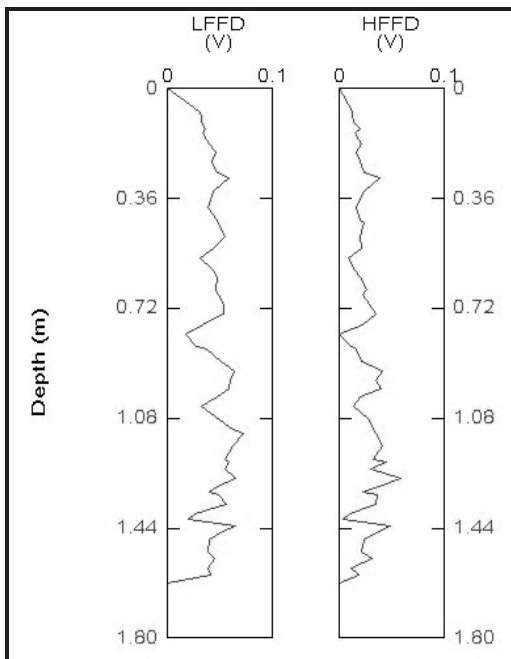

Figure 95: FFD probe analysis of BP-60.

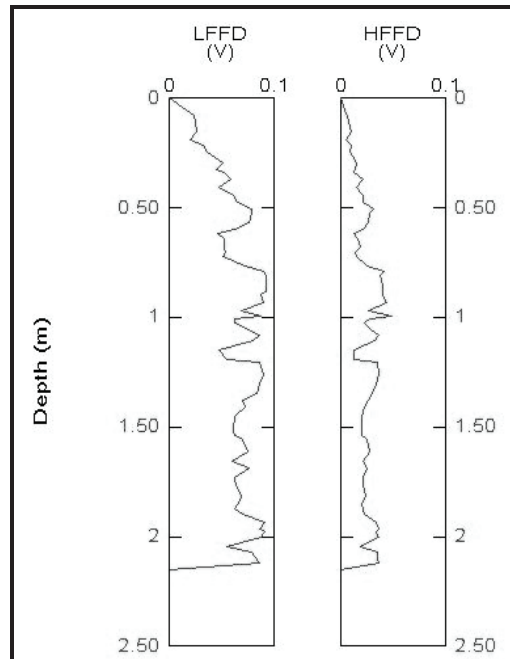

Figure 96: FFD probe analysis of BP-48.

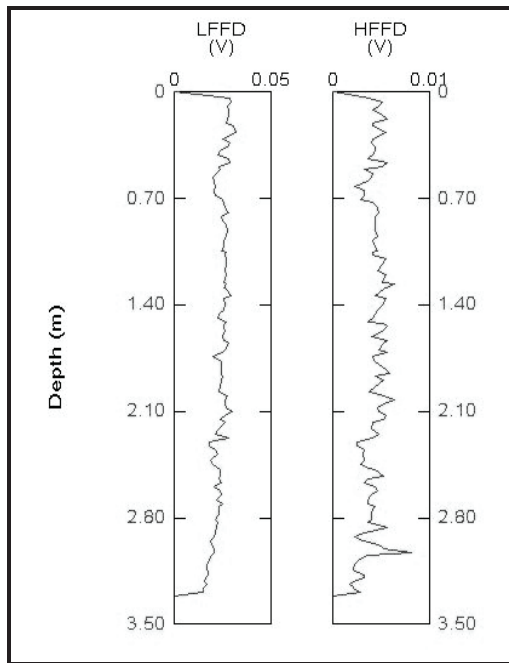

Figure 97: FFD probe analysis of BP-C.

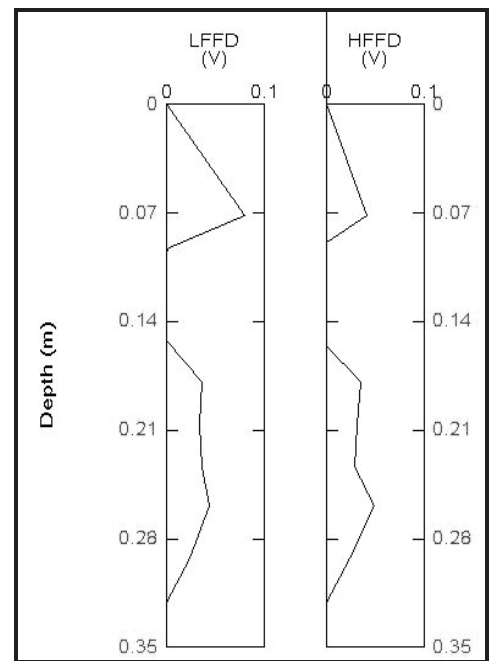

Figure 98: FFD probe analysis of BP-84.

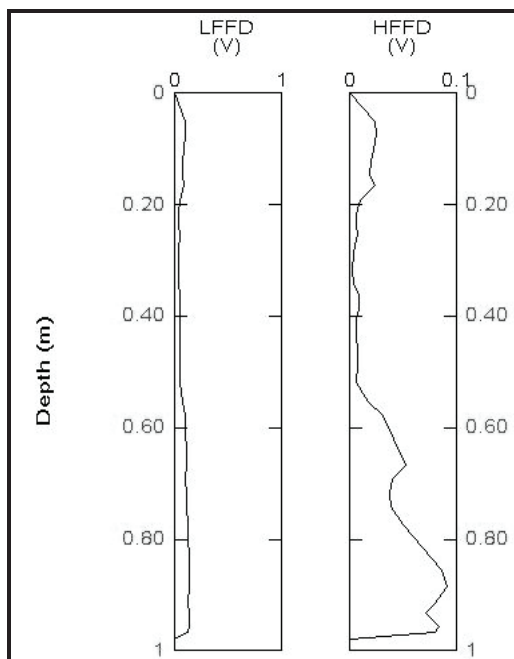

Figure 99: FFD probe analysis of BP-85.

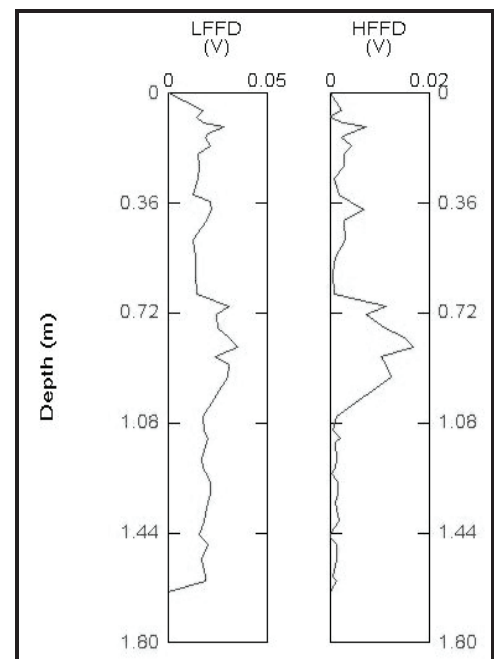

Figure 100: FFD probe analysis of BP-83.

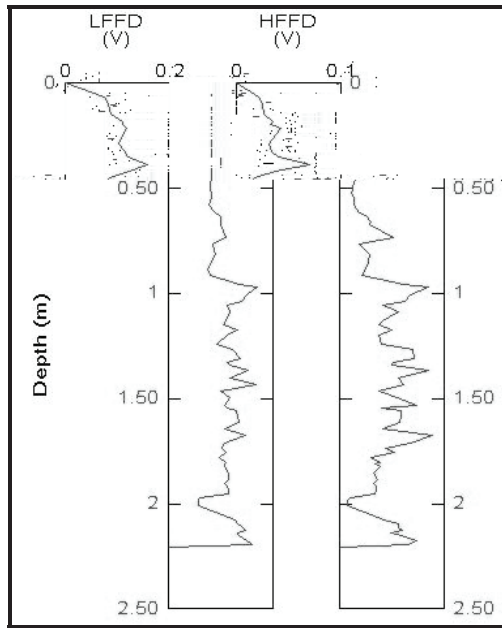

Figure 101: FFD probe analysis of BP-81.

Appendix C

Discussion of Blind Pass Core Study in Relation to Sediment Quality Guidelines and Soil Cleanup Target Level Guidance Documents

Interpretation of the petroleum hydrocarbon concentration data from sediment sampled in the Blind Pass core study may be addressed by an examination of the applicable NOAA and FDEP guidelines. Overviews on this topic have been published by both NOAA's National Status and Trends Program (SQuiRT, 2008) and the FDEP (MacDonald, 1994). Since no national criteria or widely applicable numerical tools exist, it is difficult to assess possible effects of particular chemical concentrations in sediments. However, several numerical sediment quality guidelines have been developed as informal interpretive tools.

NOAA's sediment quality guidelines were not developed as regulatory criteria or standards, nor were they intended to serve as cleanup or remediation targets. They were also not intended for pass-fail criteria for dredged material or any other regulatory purpose. Instead, they were developed and intended to provide informal guidelines for use in interpreting chemical data from analyses of sediment. These guidelines were derived using endpoints at which adverse effects in biota were documented. The 10th and 50th percentiles were identified for each chemical tested. The 10th percentile values were named "effects range-low," indicative of concentrations below which adverse effects rarely occur. The 50th percentile (median) values were named "effects range-median," representative of concentrations above which effects frequently occur.

The FDEP's sediment quality guidelines were also derived using endpoints at which adverse effects were reported to biota. The threshold effective level is calculated as the geometric mean of the 15th percentile concentration of the toxic effects data and the median of the no-effect data. It represents the concentration below which adverse effects rarely occur. The possible effective level is calculated as the geometric mean of 50% of impacted toxic samples and 85% of the non-impacted samples. It represents concentrations above which effects frequently occur.

The FDEP's Division of Waste Management-Bureau of Petroleum Storage Systems developed total recoverable petroleum hydrocarbon guidelines for soil dveid-8.9TJ 10t1g3(e)1t lelops-11.5(dv]TJ -20.6

Table 1: Blind Pass total polycyclic aromatic hydrocarbon results compared to the sediment quality guidelines developed by NOAA and the FDEP. Note that the Blind Pass values are considerably below NOAA's effects range-low and effects range-median values and the FDEP's threshold effective and possible effective levels.

BP Sediment Cores	Total Polycyclic Aromatic Hydrocarbons (µg/Kg)	NOAA		FDEP	
		Effects Range-Low	Effects Range-Median	Threshold Effective Level	Possible Effective Level
BP-97 (192-197 cm)	0.0	4022	44792	1684	16770
BP-70 (24-26 cm)	0.0	4022	44792	1684	16770
BP-76 (224-229 cm)	43.2	4022	44792	1684	16770
BP-39 (231-238 cm)	26.4	4022	44792	1684	16770
BP-81 (250-260 cm)	45.9	4022	44792	1684	16770
BP-81 (312-317 cm)	128.5	4022	44792	1684	16770
BP-81 (328-338 cm)	1.7	4022	44792	1684	16770
BP-83 (70-75 cm)	24.5	4022	44792	1684	16770
BP-24 (293-294 cm)	89.6	4022	44792	1684	16770
BP-24 (359-360 cm)	7.6	4022	44792	1684	16770
BP-26 (262-263 cm)	70.2	4022	44792	1684	16770
BP-31 (183-188 cm)	12.1	4022	44792	1684	16770
BP-31 (214-219 cm)	26.7	4022	44792	1684	16770
BP-31 (265-271 cm)	54.8	4022	44792	1684	16770
BP-45 (225-230 cm)	145.3	4022	44792	1684	16770
BP-91 (238-243 cm)	16.7	4022	44792	1684	16770
BP-88 (215-217 cm)	17.3	4022	44792	1684	16770
BP-90 (221-223 cm)	27.0	4022	44792	1684	16770
BP-C (256-261 cm)	44.4	4022	44792	1684	16770

In this study, the threshold effective level and possible effective level values have been depicted graphically with the concentrations of individual petroleum hydrocarbons in the Blind Pass sediment cores shown. All concentrations of individual petroleum hydrocarbon species were lower than the FDEP's threshold effective level values at which adverse biota effects rarely occur.

The soil cleanup target levels for the Blind Pass total recoverable petroleum hydrocarbon values listed in Table 2 were calculated by the FDEP's Bureau of Petroleum Storage Systems. Only one value from sediment core BP-81 (312-317 cm) exhibited a value slightly higher than the minimum soil cleanup target level value for freshwater/marine surface waters. The FL-PRO method does not distinguish between aliphatics and the more toxic aromatics but, by analyzing these samples through the use of GC/FID, individual hydrocarbons that were present could be

evaluated. It was found that the C₁₆-C₃₅ aliphatics comprised the bulk of the petroleum hydrocarbons in the sample, rather than the more toxic aromatics. In general, the aromatics were found at low levels and in only some of the samples.

The original laboratory sampling to evaluate the presence of petroleum hydrocarbons routinely involved one subsample collected from each sediment core. After our initial surveys, additional subsamplings were undertaken to examine horizons above and below core levels in which petroleum hydrocarbons were detected. This was performed in an effort to better characterize the petroleum hydrocarbon concentrations in the sediment cores. The sediment cores that had zones of petroleum hydrocarbon contamination were BP-81 (250-338 cm), BP-45 (189-272 cm), BP-39 (168-266 cm), BP-1 (239-254 cm), BP-24 (116-360 cm), and BP-31 (183-271 cm). All exhibited sediment quality guideline values below the levels at which adverse effects rarely occur (Table 1). However, when examined using the FDEP’s soil cleanup target levels in Table 2, BP-81 (346 mg/Kg) did exhibit a value slightly higher than the soil cleanup target level value of 340 mg/Kg.

The sediment quality guidelines are only guidelines by which to evaluate the potential effects that concentrations of certain chemicals may pose to the surrounding environment. They do not represent official NOAA policy and do not constitute criteria or clean-up levels. NOAA does not endorse their use for any other purpose.

In summary, all concentrations of individual petroleum hydrocarbon species were lower than the FDEP threshold effective level values at which adverse biota effects rarely occur. The BP-81 sample (312-317 cm) was not dominated by toxic aromatics.

Table 2. Blind Pass total recoverable petroleum hydrocarbon results from sediment cores compared to the FDEP’s soil cleanup target levels for total recoverable petroleum hydrocarbons. Note the soil cleanup target level value for one core, BP-81 (312-317cm), is slightly higher than the guideline for groundwater and freshwater/marine surface water criteria.

Blind Pass Sediment Core	Blind Pass Total Recoverable Petroleum Hydrocarbons (mg/Kg)	Direct Exposure Residential	Direct Exposure Commercial Industrial	Leachability Groundwater Criteria	Leachability Freshwater/Marine Surface Water Criteria
BP-C (256-261 cm)	9.3	460	2700	340	340
BP-57 (229-234 cm)	8.8	460	2700	340	340
BP-86 (246-249 cm)	21.2	460	2700	340	340
BP-88 (215-217 cm)	4.2	460	2700	340	340
BP-90 (221-223 cm)	6.5	460	2700	340	340
BP-24 (116-121 cm)	5.7	460	2700	340	340
BP-24 (293-294 cm)	21.7	460	2700	340	340
BP-24 (359-360 cm)	14.2	460	2700	340	340
BP-26 (262-263 cm)	5.7	460	2700	340	340

Table 2. Blind Pass total recoverable petroleum hydrocarbon results from sediment cores compared to the FDEP's soil cleanup target levels for total recoverable petroleum hydrocarbons. Note the soil cleanup target level value for one core, BP-81 (312-317cm), is slightly higher than the guideline for groundwater and freshwater/marine surface water criteria.

Blind Pass Sediment Core	Blind Pass Total Recoverable Petroleum Hydrocarbons (mg/Kg)	Direct Exposure Residential	Direct Exposure Commercial Industrial	Leachability Groundwater Criteria	Leachability Freshwater/Marine Surface Water Criteria
BP-31 (183-188 cm)	2.6	460	2700	340	340
BP-31 (214-219 cm)	5.9	460	2700	340	340
BP-31 (265-271 cm)	9.8	460	2700	340	340
BP-40 (109-119 cm)	4.1	460	2700	340	340
BP-45 (189-194 cm)	3.5	460	2700	340	340
BP-45 (225-230 cm)	14.6	460	2700	340	340
BP-45 (266-272 cm)	110.0	460	2700	340	340
BP-91 (238-243 cm)	2.5	460	2700	340	340
BP-1 (239-244 cm)	1.8	460	2700	340	340
BP-1 (249-254 cm)	55.9	460	2700	340	340
BP-39 (168-178 cm)	4.1	460	2700	340	340
BP-39 (231-238 cm)	38.0	460	2700	340	340
BP-39 (256-266 cm)	3.4	460	2700	340	340
BP-81 (250-260 cm)	32.6	460	2700	340	340
BP-81 (312-317 cm)	346.0	460	2700	340	340
BP-81 (328-338 cm)	7.2	460	2700	340	340
BP-82 (36-40 cm)	2.2	460	2700	340	340
BP-83 (70-75 cm)	10.9	460	2700	340	340
BP-35 (116-120 cm)	14.9	460	2700	340	340
BP-59 (186-191 cm)	2.7	460	2700	340	340
BP-70 (24-26 cm)	66.3	460	2700	340	340
BP-70 (236-241 cm)	2.9	460	2700	340	340
BP-73 (48-53 cm)	6.8	460	2700	340	340
BP-76 (78-81 cm)	1.6	460	2700	340	340
BP-76 (224-229 cm)	7.0	460	2700	340	340
BP-97 (192-197 cm)	30.6	460	2700	340	340

Appendix D

John's Pass Sediment Cores Petroleum Hydrocarbon Characterization

Sediment cores were collected in anticipation of future John's Pass dredging operations. A total of 15 cores were collected by Dr. Ping Wang (University of South Florida) from a shoal area outside of John's Pass in October 2008 (Figure 1). One-half of each sediment core was retained by USF for grain size and sediment analyses, and the other half was transported to AOML in Miami, Florida for petroleum hydrocarbon characterization.

No visual evidence of petroleum hydrocarbons was observed in any of the 15 sediment cores collected. A total of 14 subsamples were collected for GC/FID C₈-C₄₀ petroleum hydrocarbon analyses. The core horizons sampled for these analyses are indicated by a red circle within each photo (Figures 2-15).

Two of the 14 subsamples exhibited relatively low levels of total petroleum hydrocarbons, but were above detection limits using the C₈-C₄₀ concentration method (Tables 1-14). The sampling horizon in sediment cores JP-7 and JP-9 exhibited total petroleum hydrocarbon concentrations of 25.4 mg/Kg and 12.5 mg/Kg respectively.

Chromatograms corresponding to the results in Tables 1-14 are also shown for each subsample. The chromatograms of JP-7 and JP-9 indicate concentrations in addition to the calibration peaks, which indicate above-detection levels for petroleum hydrocarbons.

Figure 16 shows the instrument calibration for the GC/MS. GC/MS speciation analyses were conducted on the two subsample extracts from sediment cores JP-7 and JP-9 in order to determine which individual hydrocarbons were present (Tables 15 and 16). Volatile and semi-volatile hydrocarbons present in sediment core JP-7 were methyl-tert-butyl-ether (1.76 µg/Kg), m&p-xylene (1.56 µg/Kg), 1,3,5-trimethylbenzene (1.28 µg/Kg), 4-chlorotoulene (0.99 µg/Kg), 1,2,4-trimethylbenzene (1.37 µg/Kg), n-butylbenzene (1.46 µg/Kg), and n-propylbenzene (2.13 µg/Kg). The non-volatile hydrocarbons present were phenanthrene (1.02 µg/Kg), fluoranthene (2.13 µg/Kg), benzo(b)fluoranthene (9.47 µg/Kg), benzo(a)pyrene (17.5 µg/Kg), benzo(ghi)perylene (7.29 µg/Kg), pyrene (1.99 µg/Kg), indeno(1,2,3-cd)pyrene (5.91 µg/Kg), and dibenzo(a,h)anthracene (7.11 µg/Kg). This sample also contained 75.6 µg/Kg C₁₆-C₂₁ aromatics and 25,400 µg/Kg C₁₆-C₃₅ aliphatics.

Sediment core JP-9 was found to contain 2.74 µg/Kg methyl-tert-butyl-ether and 12,500 µg/Kg of C₁₆-C₃₅ aliphatics. About half of the individual petroleum hydrocarbons found in the two positive samples were found in a *Bouchard 155* reference sample collected after an oil spill which contaminated the areas within and outside John's Pass in 1993 (Table 17). No clear discrimination of the source of the low concentrations of petroleum hydrocarbons was evident, but they may, in part, be residual from the 1993 oil spill.

The fuel fluorescence detector (FFD) was passed along the length of each sediment core to examine if concentrations of petroleum hydrocarbons were within the detection limits of the instrument. The two subsamples which contained petroleum hydrocarbons were below detection levels of the FFD probe (100 ppm or mg/Kg). Although peaks of fluorescence are evident in each graph of the FFD data (Figures 17-30), no peaks reached fluorescence levels above background.

In summary, two of the 14 collected cores exhibited low, but above-detection levels of petroleum hydrocarbons. In addition, speciation analyses of these samples revealed the presence of particular hydrocarbons which exhibited some affinity to the *Bouchard 155* spill sample. According to NOAA and FDEP informal sediment quality guidelines, the levels found in this study are below levels considered hazardous in sediment.

2008 Johns Pass Core Locations

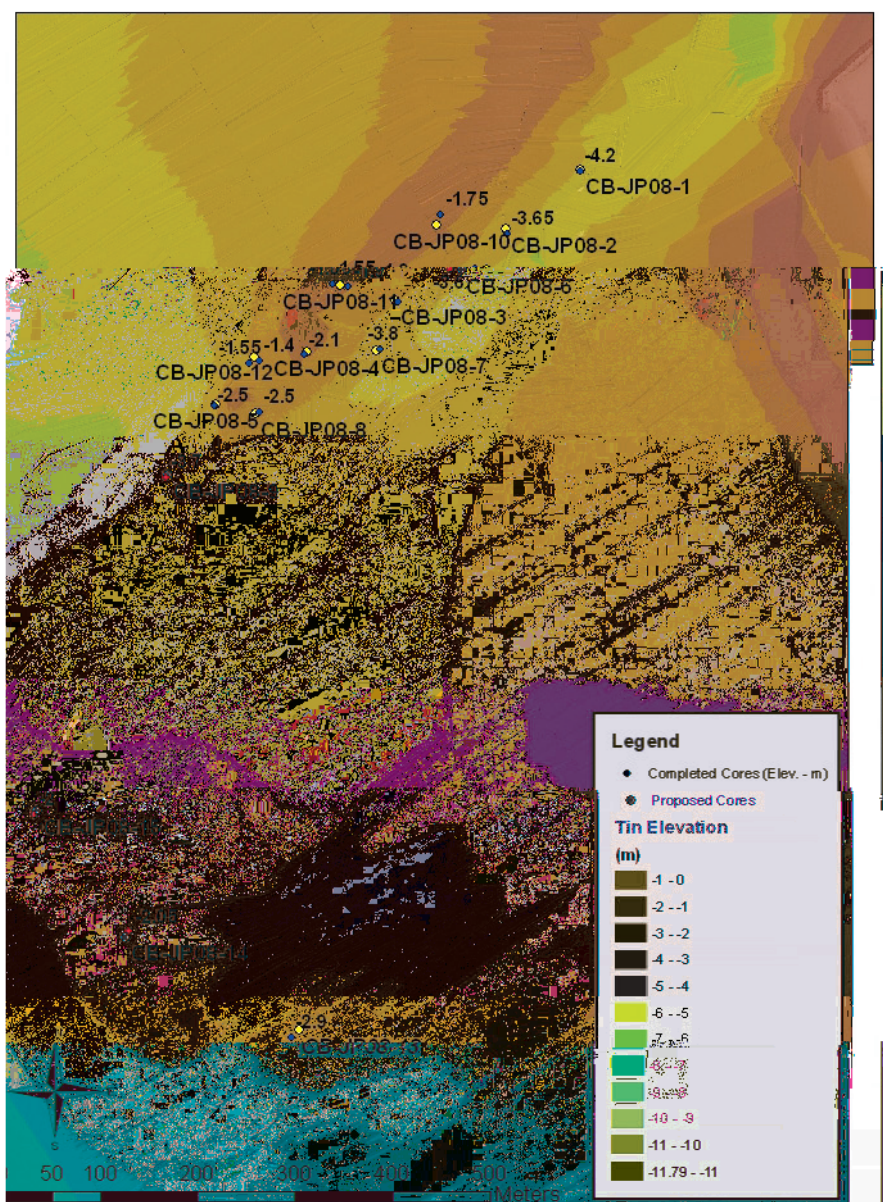

Figure 1: Sites at which sediment cores were collected in John's Pass (Tanya Beck, USF).

JOHN'S PASS SEDIMENT CORE JP-1 (115-120 CM)



Figure 2. Subsample of sediment core JP-1 (115-120 cm).

Table 1: Core JP-1 (115-120 cm) - GC/FID Hydrocarbon Analysis Data						
PARAMETER	RESULT	QC	UNITS	MDL	PQL	METHOD
Percent Solids	79.1		%	0.1	0.3	EPA 160.3
FL-PRO (Petroleum Residual Organic Totals) Soil Dilution Factor = 1						
TOTAL PRO (C8-C40)	U	U	mg/Kg	0.01	0.03	FL-PRO

QC=Qualifier Code as defined by DEP 62-160; U=Undetected; I=In between the MDL and PQL; Q= Out of hold; MDL=Minimum Detection Limit; PQL=Practical Quantation Limit.

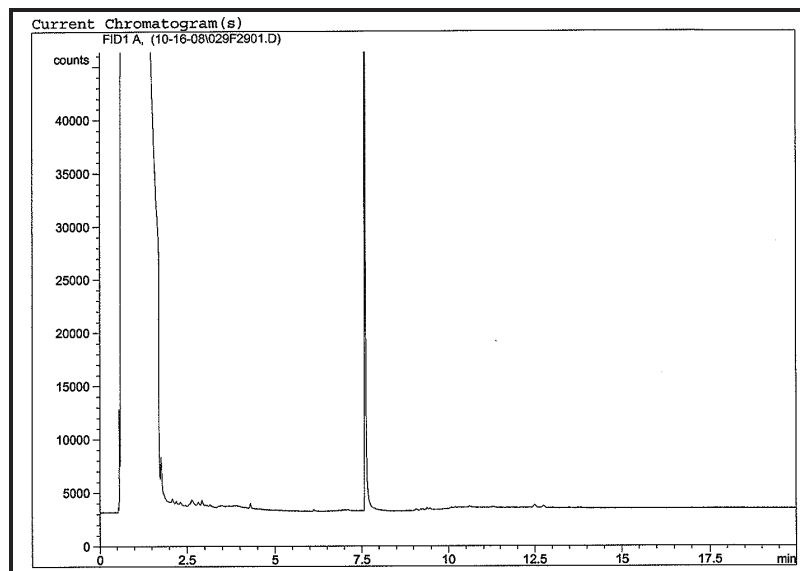

Chromatogram of sediment core JP-1 (115-120 cm).

JOHN'S PASS SEDIMENT CORE JP-3 (85-90 CM)



Figure 3: Subsample of sediment core JP-3 (85-90 cm).

Table 2: Core JP-3 (85-90 cm) - GC/FID Hydrocarbon Analysis Data						
PARAMETER	RESULT	QC	UNITS	MDL	PQL	METHOD
Percent Solids	83.2		%	0.1	0.3	EPA 160.3
FL-PRO (Petroleum Residual Organic Totals) Soil Dilution Factor = 1						
TOTAL PRO (C8-C40)	U	U	mg/Kg	0.01	0.03	FL-PRO

QC=Qualifier Code as defined by DEP 62-160; U=Undetected; I=In between the MDL and PQL; Q= Out of hold; MDL=Minimum Detection Limit; PQL=Practical Quantation Limit.

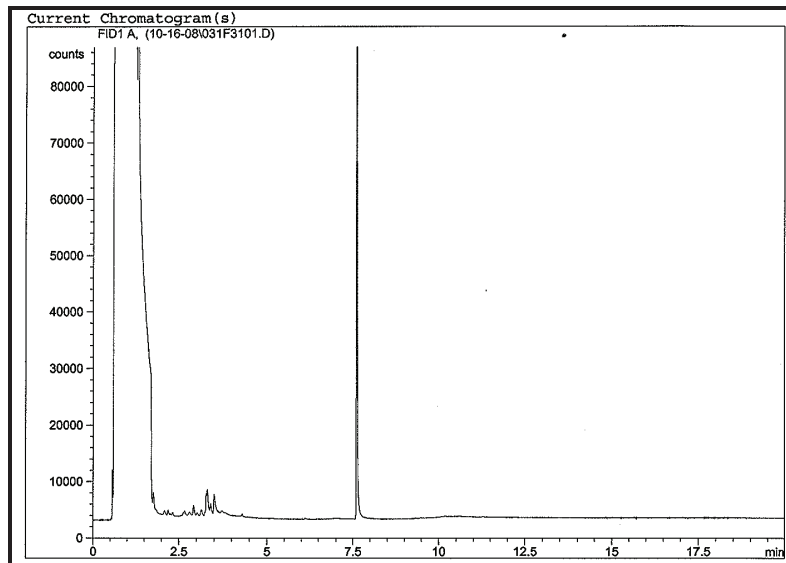

Chromatograph of sediment core JP-3 (85-90 cm).

JOHN'S PASS SEDIMENT CORE JP-4 (185-190 CM)

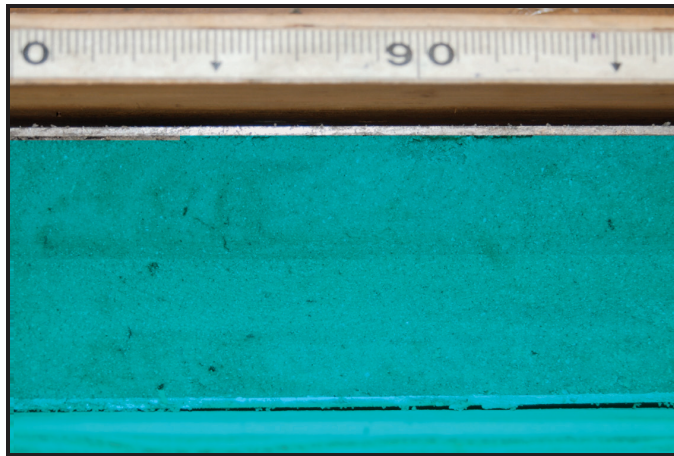
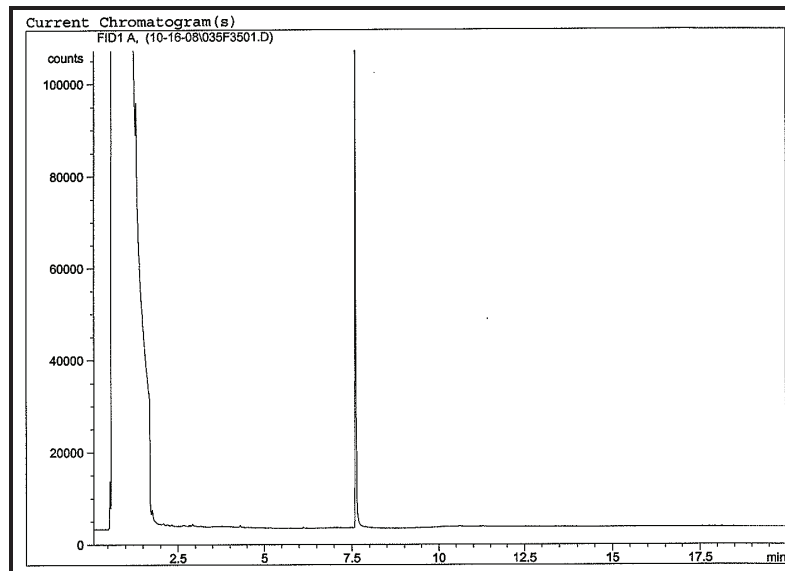

Figure 4: Subsample of sediment core JP-4 (185-190 cm).

Table 3: Core JP-4 (185-190 cm) - GC/FID Hydrocarbon Analysis Data						
PARAMETER	RESULT	QC	UNITS	MDL	PQL	METHOD
Percent Solids	81.0		%	0.1	0.3	EPA 160.3
FL-PRO (Petroleum Residual Organic Totals) Soil Dilution Factor = 1						
TOTAL PRO (C8-C40)	U	U	mg/Kg	0.01	0.03	FL-PRO

QC=Qualifier Code as defined by DEP 62-160; U=Undetected; I=In between the MDL and PQL; Q= Out of hold; MDL=Minimum Detection Limit; PQL=Practical Quantation Limit.



Chromatogram of sediment core JP-4 (185-190 cm).

JOHN'S PASS SEDIMENT CORE JP-5 (160-165 CM)

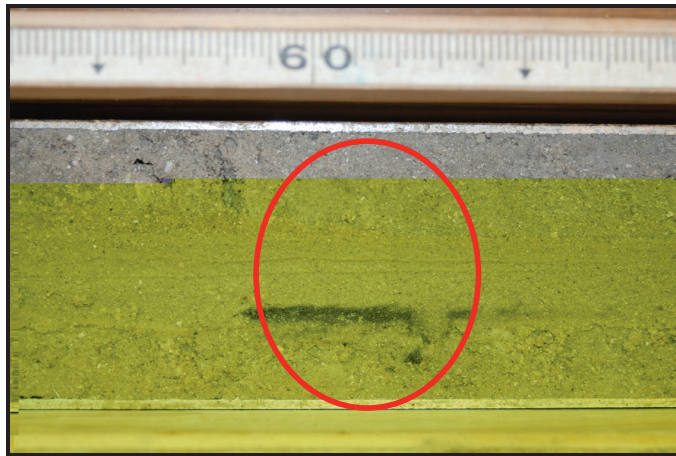
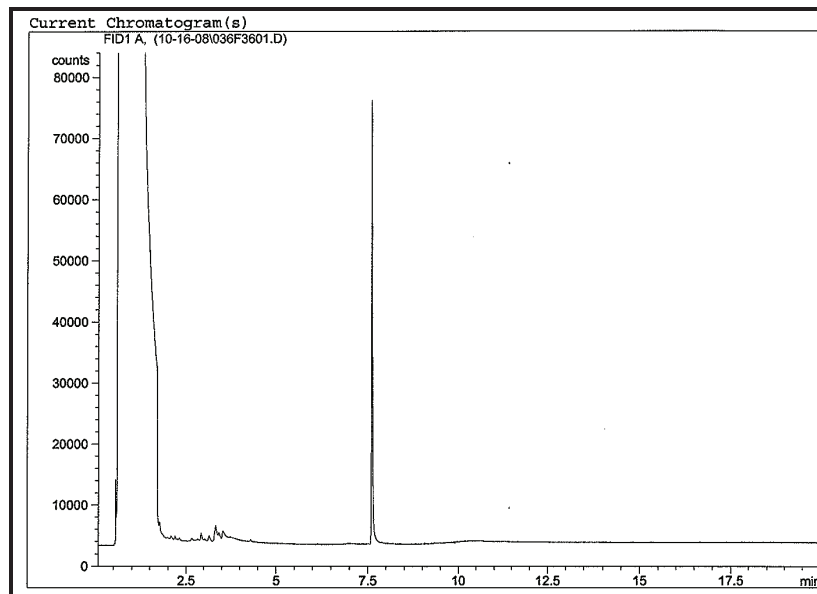

Figure 5: Subsample of sediment core JP-5 (160-165 cm)

Table 4: Core JP-5 (160-165 cm) - GC/FID Hydrocarbon Analysis Data

PARAMETER	RESULT	QC	UNITS	MDL	PQL	METHOD
Percent Solids	79.3		%	0.1	0.3	EPA 160.3
FL-PRO (Petroleum Residual Organic Totals) Soil Dilution Factor = 1						
TOTAL PRO (C8-C40)	U	U	mg/Kg	0.01	0.03	FL-PRO

QC=Qualifier Code as defined by DEP 62-160; U=Undetected; I=In between the MDL and PQL; Q= Out of hold; MDL=Minimum Detection Limit; PQL=Practical Quantation Limit.



Chromatograph of sediment core JP-5 (160-165 cm).

JOHN'S PASS SEDIMENT CORE JP-6 (65-70 CM)

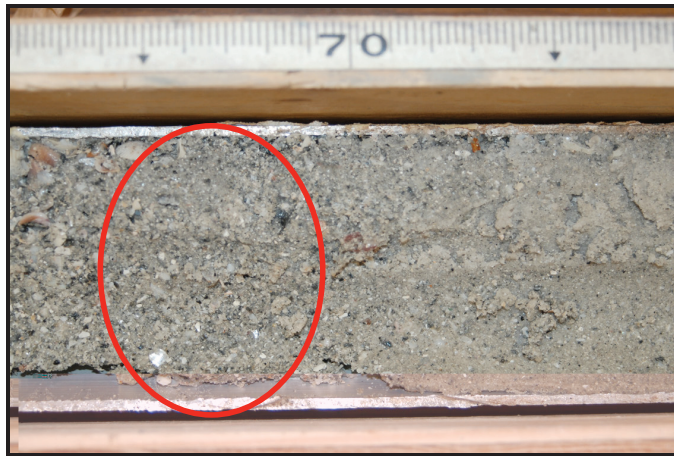
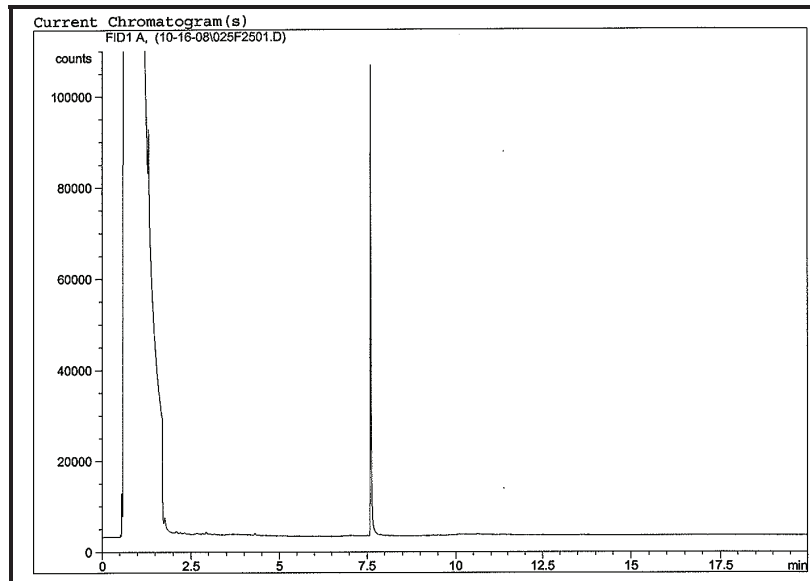

Figure 6: Subsample of sediment core JP-6 (65-70 cm).

Table 5: Core JP-6 (65-70 cm) - GC/FID Hydrocarbon Analysis Data						
PARAMETER	RESULT	QC	UNITS	MDL	PQL	METHOD
Percent Solids	81.6		%	0.1	0.3	EPA 160.3
FL-PRO (Petroleum Residual Organic Totals) Soil Dilution Factor = 1						
TOTAL PRO (C8-C40)	U	U	mg/Kg	0.01	0.03	FL-PRO

QC=Qualifier Code as defined by DEP 62-160; U=Undetected; I=In between the MDL and PQL; Q= Out of hold; MDL=Minimum Detection Limit; PQL=Practical Quantation Limit.



Chromatograph of sediment core JP-6 (65-70 cm).

JOHN'S PASS SEDIMENT CORE JP-7 (145-150 CM)

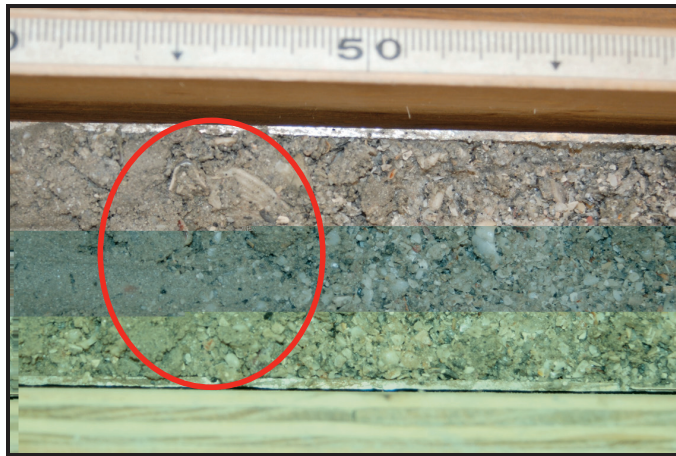
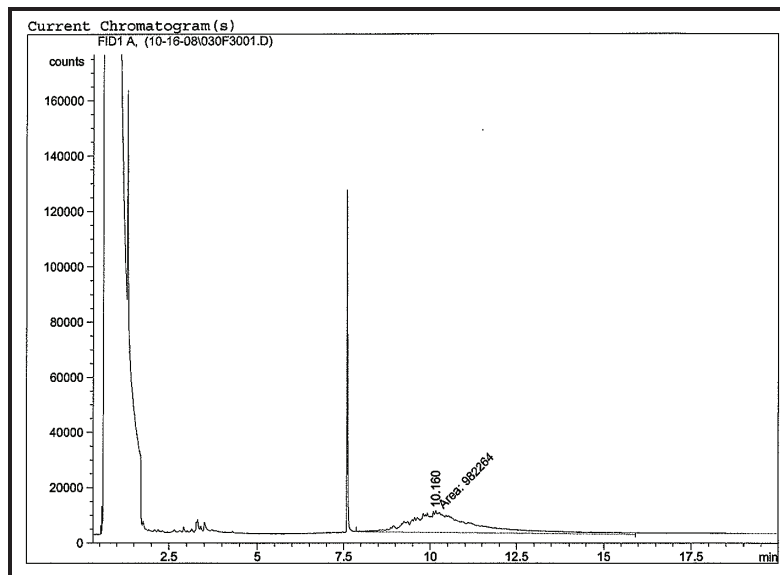

Figure 7: Subsample of sediment core JP-7 (145-150 cm).

Table 6: Core JP-7 (145-150 cm) - GC/FID Hydrocarbon Analysis Data						
PARAMETER	RESULT	QC	UNITS	MDL	PQL	METHOD
Percent Solids	86.4		%	0.1	0.3	EPA 160.3
FL-PRO (Petroleum Residual Organic Totals) Soil Dilution Factor = 1						
TOTAL PRO (C8-C40)	25.4		mg/Kg	0.01	0.03	FL-PRO

QC=Qualifier Code as defined by DEP 62-160; U=Undetected; I=In between the MDL and PQL; Q= Out of hold; MDL=Minimum Detection Limit; PQL=Practical Quantation Limit.



Chromatogram of sediment core JP-7 (145-250 cm).

JOHN'S PASS SEDIMENT CORE JP-8 (180-185 CM)



Figure 8: Subsample of sediment core JP-8 (180-185 cm).

Table 7: Core JP-8 (180-185 cm) - GC/FID Hydrocarbon Analysis Data						
PARAMETER	RESULT	QC	UNITS	MDL	PQL	METHOD
Percent Solids	81.6		%	0.1	0.3	EPA 160.3
FL-PRO (Petroleum Residual Organic Totals) Soil Dilution Factor = 1						
TOTAL PRO (C8-C40)	U	U	mg/Kg	0.01	0.03	FL-PRO

QC=Qualifier Code as defined by DEP 62-160; U=Undetected; I=In between the MDL and PQL; Q= Out of hold; MDL=Minimum Detection Limit; PQL=Practical Quantation Limit.

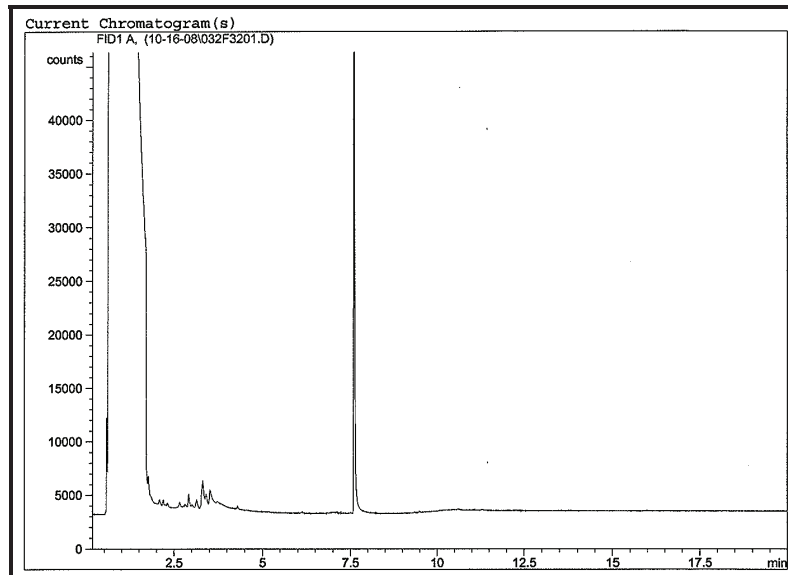

Chromatograph of sediment core JP-8 (180-185 cm).

JOHN'S PASS SEDIMENT CORE JP-9 (70-75 CM)

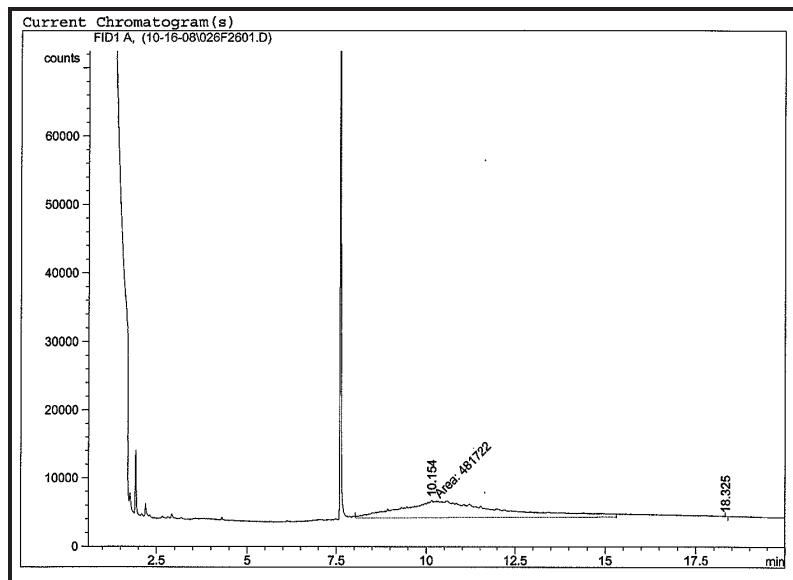

Figure 9: Subsample of sediment core JP-9 (70-75 cm).

Table 8: Core JP-9 (70-75 cm) - GC/FID Hydrocarbon Analysis Data

PARAMETER	RESULT	QC	UNITS	MDL	PQL	METHOD
Percent Solids	78.9		%	0.1	0.3	EPA 160.3
FL-PRO (Petroleum Residual Organic Totals) Soil Dilution Factor = 1						
TOTAL PRO (C8-C40)	12.5		mg/Kg	0.01	0.03	FL-PRO

QC=Qualifier Code as defined by DEP 62-160; U=Undetected; I=In between the MDL and PQL; Q= Out of hold; MDL=Minimum Detection Limit; PQL=Practical Quantation Limit.



Chromatograph of sediment core JP-9 (70-75 cm).

JOHN'S PASS SEDIMENT CORE JP-10 (88-93 CM)



Figure 10: Subsample of sediment core JP-10 (88-93 cm).

Table 9: Core JP-10 (88-93 cm) - GC/FID Hydrocarbon Analysis Data						
PARAMETER	RESULT	QC	UNITS	MDL	PQL	METHOD
Percent Solids	81.2		%	0.1	0.3	EPA 160.3
FL-PRO (Petroleum Residual Organic Totals) Soil Dilution Factor = 1						
TOTAL PRO (C8-C40)	U	U	mg/Kg	0.01	0.03	FL-PRO

QC=Qualifier Code as defined by DEP 62-160; U=Undetected; I=In between the MDL and PQL; Q= Out of hold; MDL=Minimum Detection Limit; PQL=Practical Quantation Limit.

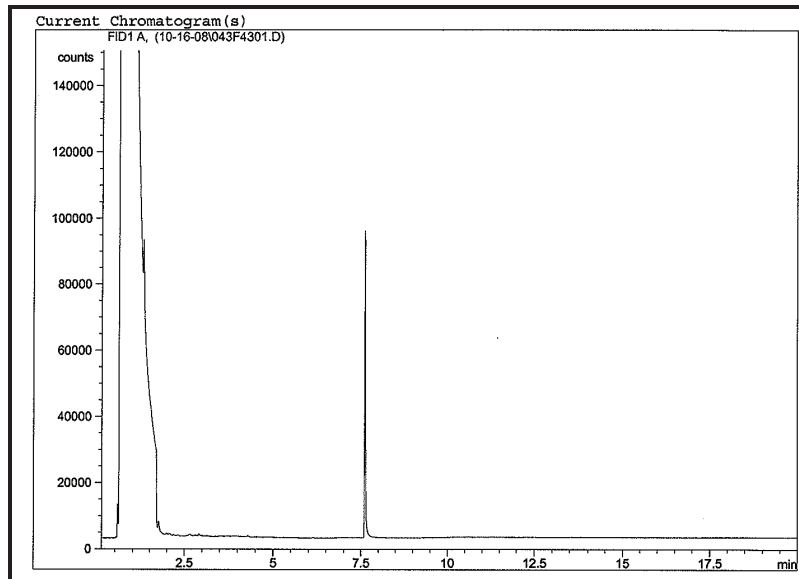

Chromatogram of sediment core JP-10 (88-93 cm).

JOHN'S PASS SEDIMENT CORE JP-11-2 (148-153 CM)



Figure 11: Subsample of sediment core JP-11-2 (148-153 cm).

Table 10: Core JP-11(2) (148-153 cm) - GC/FID Hydrocarbon Analysis Data						
PARAMETER	RESULT	QC	UNITS	MDL	PQL	METHOD
Percent Solids	80.2		%	0.1	0.3	EPA 160.3
FL-PRO (Petroleum Residual Organic Totals) Soil Dilution Factor = 1						
TOTAL PRO (C8-C40)	U	U	mg/Kg	0.01	0.03	FL-PRO

QC=Qualifier Code as defined by DEP 62-160; U=Undetected; I=In between the MDL and PQL; Q= Out of hold; MDL=Minimum Detection Limit; PQL=Practical Quantation Limit.

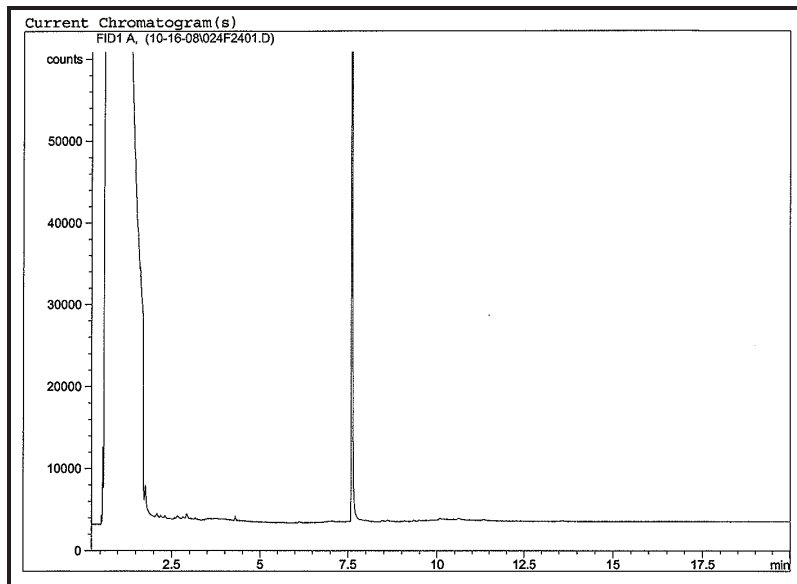

Chromatogram of sediment core JP-11-2 (148-153 cm).

JOHN'S PASS SEDIMENT CORE JP-12-2 (120-125 CM)



Figure 12: Subsample of sediment core JP-12-2 (120-125 cm).

Table 11: Core JP-12 (2) (120-125 cm) - GC/FID Hydrocarbon Analysis Data						
PARAMETER	RESULT	QC	UNITS	MDL	PQL	METHOD
Percent Solids	84.1		%	0.1	0.3	EPA 160.3
FL-PRO (Petroleum Residual Organic Totals) Soil Dilution Factor = 1						
TOTAL PRO (C8-C40)	U	U	mg/Kg	0.01	0.03	FL-PRO

QC=Qualifier Code as defined by DEP 62-160; U=Undetected; I=In between the MDL and PQL; Q= Out of hold; MDL=Minimum Detection Limit; PQL=Practical Quantation Limit.

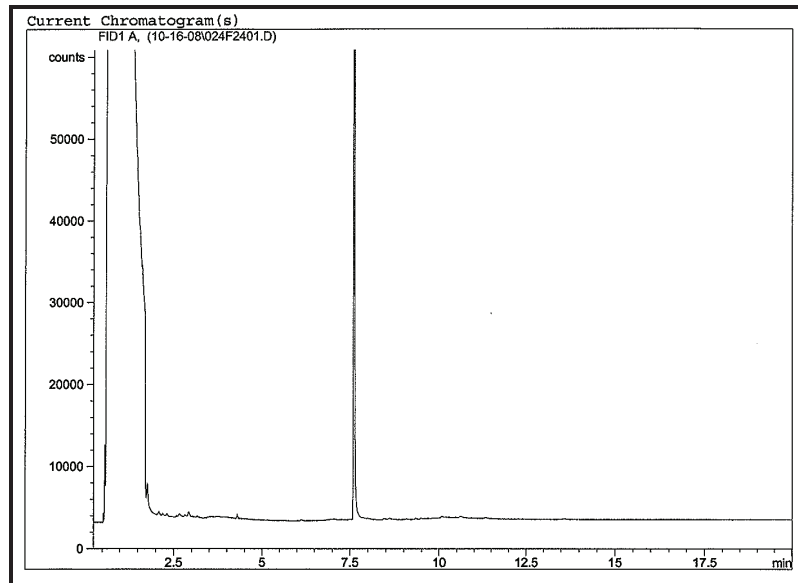

Chromatograph of sediment core JP-12-2 (120-125 cm).

JOHN'S PASS SEDIMENT CORE JP-13 (65-70 CM)

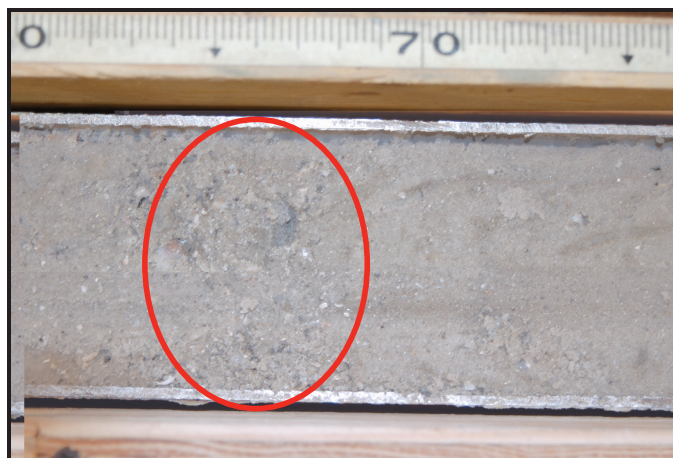
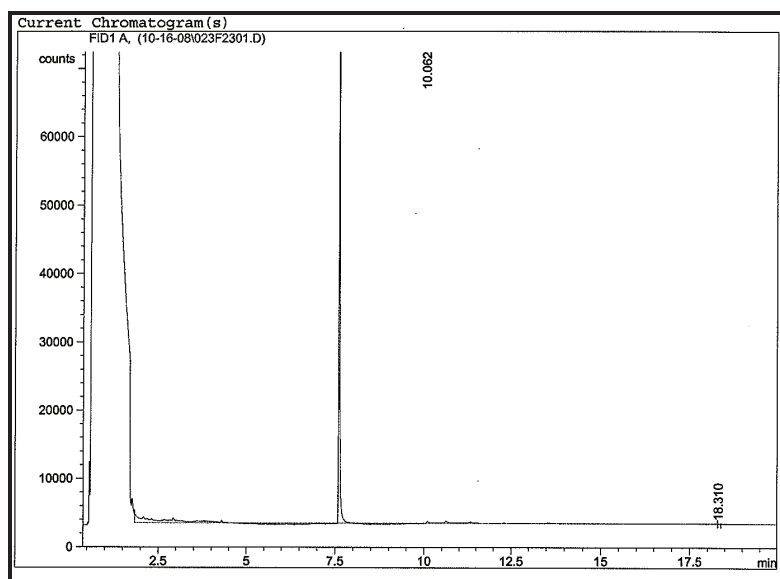

Figure 13: Subsample of sediment core JP-13 (65-70 cm).

Table 12: Core JP-13 (65-70 cm) - GC/FID Hydrocarbon Analysis Data

PARAMETER	RESULT	QC	UNITS	MDL	PQL	METHOD
Percent Solids	81.6		%	0.1	0.3	EPA 160.3
FL-PRO (Petroleum Residual Organic Totals) Soil Dilution Factor = 1						
TOTAL PRO (C8-C40)	U	U	mg/Kg	0.01	0.03	FL-PRO

QC=Qualifier Code as defined by DEP 62-160; U=Undetected; I=In between the MDL and PQL; Q= Out of hold; MDL=Minimum Detection Limit; PQL=Practical Quantation Limit.



Chromatogram of sediment core JP-13 (65-70 cm).

JOHN'S PASS SEDIMENT CORE JP-14 (235-240 CM)

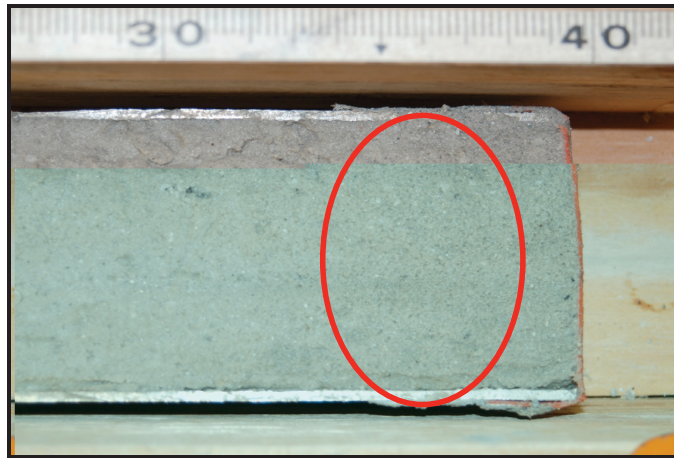
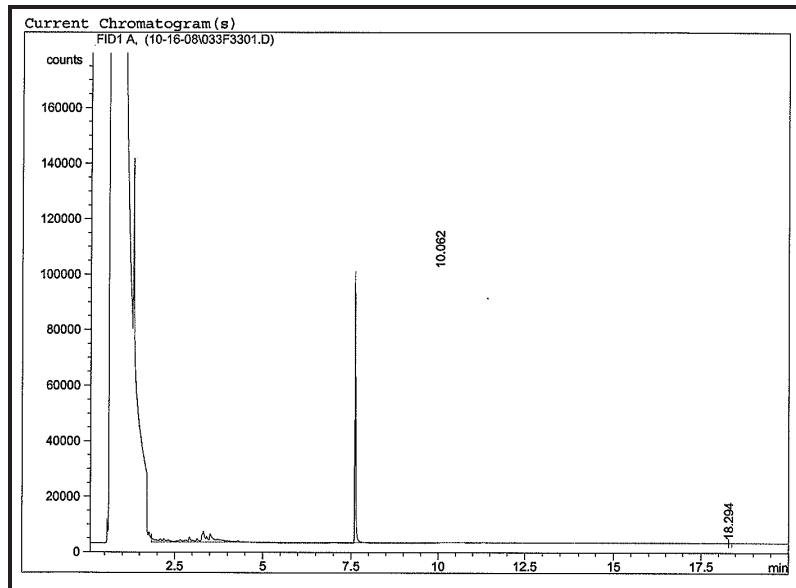

Figure 14: Subsample of sediment core JP-14 (235-240 cm).

Table 13: Core JP-14 (235-240 cm) - GC/FID Hydrocarbon Analysis Data						
PARAMETER	RESULT	QC	UNITS	MDL	PQL	METHOD
Percent Solids	81.4		%	0.1	0.3	EPA 160.3
FL-PRO (Petroleum Residual Organic Totals) Soil Dilution Factor = 1						
TOTAL PRO (C8-C40)	U	U	mg/Kg	0.01	0.03	FL-PRO

QC=Qualifier Code as defined by DEP 62-160; U=Undetected; I=In between the MDL and PQL; Q= Out of hold; MDL=Minimum Detection Limit; PQL=Practical Quantation Limit.



Chromatograph of sediment core JP-14 (235-240 cm).

JOHN'S PASS SEDIMENT CORE JP-15 (240-245 CM)

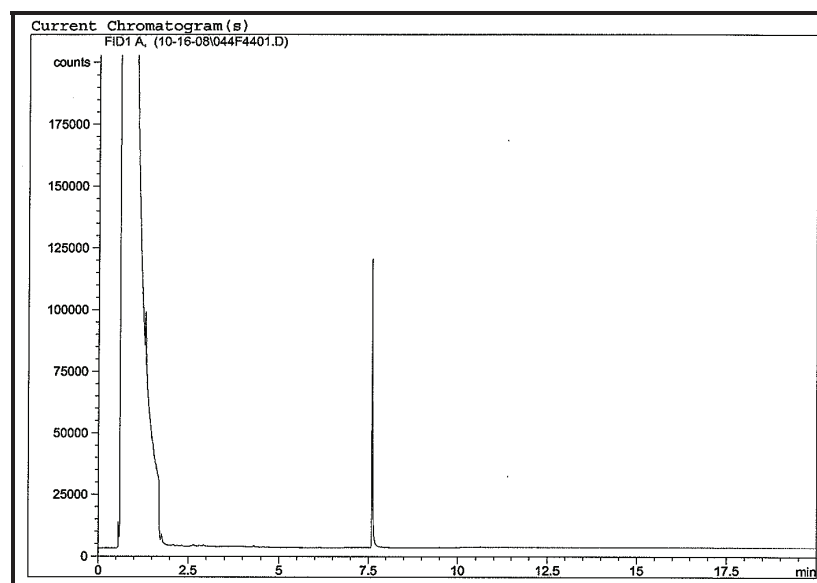

Figure 15: Subsample of sediment core JP-15 (240-245 cm).

Table 14: Core JP-15 (240-245 cm) - GC/FID Hydrocarbon Analysis Data

PARAMETER	RESULT	QC	UNITS	MDL	PQL	METHOD
Percent Solids	79.7		%	0.1	0.3	EPA 160.3
FL-PRO (Petroleum Residual Organic Totals) Soil Dilution Factor = 1						
TOTAL PRO (C8-C40)	U	U	mg/Kg	0.01	0.03	FL-PRO

QC=Qualifier Code as defined by DEP 62-160; U=Undetected; I=In between the MDL and PQL; Q= Out of hold; MDL=Minimum Detection Limit; PQL=Practical Quantation Limit.



Chromatogram of sediment core JP-15 (240-245 cm).

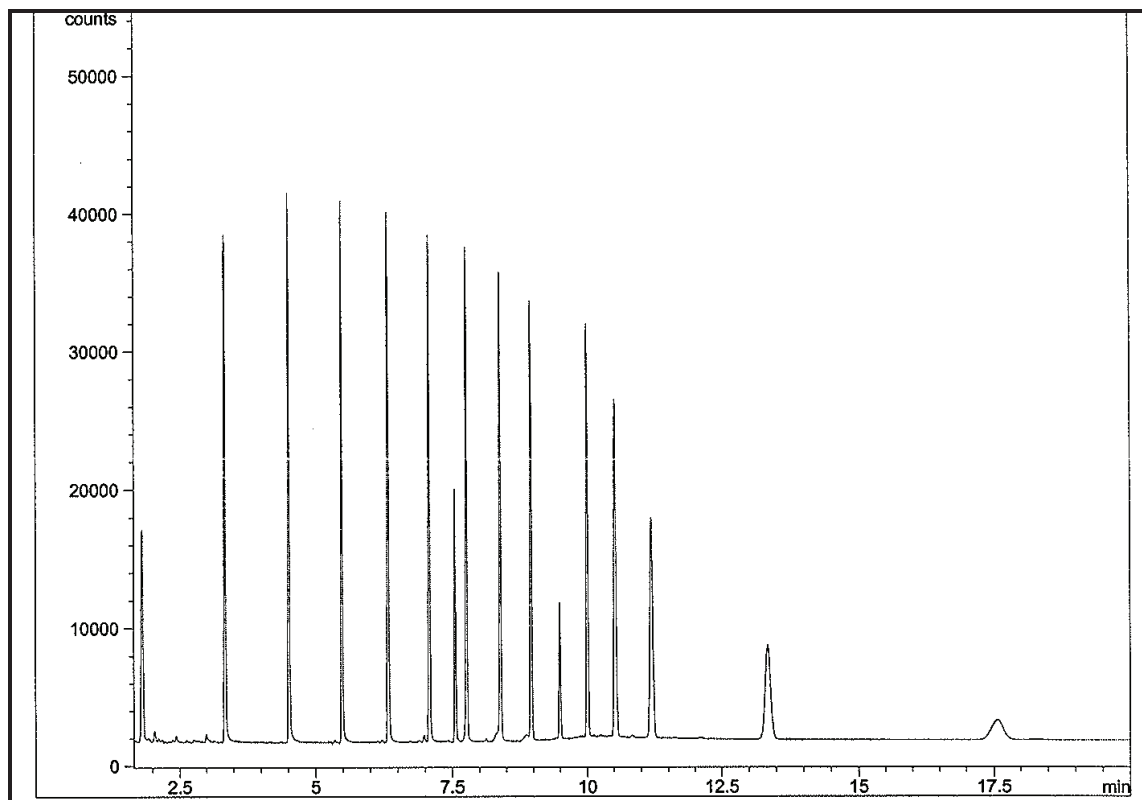

Figure 16: Instrument calibration chromatogram for GC/MS.

Table 15: GC/MS petroleum hydrocarbon speciation analysis of sediment core JP-7 (145-150 cm).						
PARAMETER	RESULT	QC	UNITS	MDL	PQL	METHOD
8260B VOA Compounds in Solids & Wastes GC/MS Dilution Factor = 1						
Methyl-tert-butyl-ether	1.76	I	µg/Kg	1.9	5.7	5030/8260B
Benzene	U	U	µg/Kg	0.85	2.55	5030/8260B
Toluene	U	U	µg/Kg	1.4	4.2	5030/8260B
Chlorobenzene	U	U	µg/Kg	2.3	6.9	5030/8260B
Ethylbenzene	U	U	µg/Kg	1.5	4.5	5030/8260B
M & p Xylene	1.56	I	µg/Kg	1.3	3.9	5030/8260B
o-Xylene	U	U	µg/Kg	1.1	3.3	5030/8260B
1,3,5-Trimethylbenzene	1.28	I	ug/Kg	0.8	2.4	5030/8260B
4-Chlorotoluene	0.99	I	µg/Kg	0.7	2.1	5030/8260B
1,2,4-Trimethylbenzene	1.37	I	µg/Kg	0.8	2.4	5030/8260B
n-Butylbenzene	1.46	I	µg/Kg	0.86	2.58	5030/8260B
n-Propylbenzene	1.05	I	ug/Kg	0.81	2.43	5030/8260B
1,3-Dichlorobenzene	U	U	µg/Kg	3.2	9.6	5030/8260B
1,4-Dichlorobenzene	U	U	µg/Kg	2.0	6.0	5030/8260B
1,2-Dichlorobenzene	U	U	µg/Kg	3.5	10.5	5030/8260B

Table 15: GC/MS petroleum hydrocarbon speciation analysis of sediment core JP-7 (145-150 cm).						
PARAMETER	RESULT	QC	UNITS	MDL	PQL	METHOD
Acenaphthylene	U	U	µg/Kg	2.0	6.0	3550/8270C
2,6-Dinitrotoluene	U	U	µg/Kg	26	78	3550/8270C
Acenaphthene	U	U	µg/Kg	1.3	3.9	3550/8270C
2,4-Dinitrophenol	U	U	µg/Kg	34	102	3550/8270C
2,4-Dinitrotoluene	U	U	µg/Kg	41	123	3550/8270C
4-Nitrophenol	U	U	µg/Kg	37	111	3550/8270C
Diethyl Phthalate	U	U	µg/Kg	35	105	3550/8270C
Fluorene	U	U	µg/Kg	1.0	3.0	3550/8270C
4-Chlorophenyl Phenyl Ether	U	U	µg/Kg	45	135	3550/8270C
4,6-Dinitro-2-Methylphenol	U	U	µg/Kg	36	108	3550/8270C
N-Nitrosodiphenylamine	U	U	µg/Kg	51	153	3550/8270C
4-Bromophenyl Phenyl Ether	U	U	µg/Kg	38	114	3550/8270C
Hexachlorobenzene	U	U	µg/Kg	36	108	3550/8270C
Pentachlorophenol	U	U	µg/Kg	1.7	5.1	3550/8270C
Phenanthrene	1.02	I	µg/Kg	2	6	3550/8270C
Anthracene	U	U	µg/Kg	0.6	1.8	3550/8270C
Di-N-Butyl Phthalate	U	U	µg/Kg	34	102	3550/8270C
Fluoranthene	2.13		µg/Kg	1.6	4.8	3550/8270C
Benzidine	U	U	µg/Kg	33	99	3550/8270C
Pyrene	1.99		µg/Kg	2	6	3550/8270C
Butyl Benzyl Phthalate	U	U	µg/Kg	50	150	3550/8270C
Benzo(A)Anthracene	U	U	µg/Kg	1	3	3550/8270C
3,3-Dichlorobenzidine	U	U	µg/Kg	100	300	3550/8270C
Chrysene	U	U	µg/Kg	1	3	3550/8270C
Bis (2 Ethylhexyl) Phthalate	U	U	µg/Kg	39	117	3550/8270C
Di-N-Octyl Phthalate	U	U	µg/Kg	44	132	3550/8270C
Benzo(B)Fluoranthene	9.47		µg/Kg	1	3	3550/8270C
Benzo(K)Fluoranthene	U	U	µg/Kg	1	3	3550/8270C
Benzo(A)Pyrene	17.5		µg/Kg	1	3	3550/8270C
Indeno(1,2,3-CD)Pyrene	5.91	U	µg/Kg	2	6	3550/8270C
Dibenzo (A,H) Anthracene	7.11		µg/Kg	2	6	3550/8270C
Benzo(G,H,I)Perylene	7.29		µg/Kg	2	6	3550/8270C
Bis-2-ethylhexyl Adipate	U	U	µg/Kg	33	99	3550/8270C
Aldrin	U	U	µg/Kg	1.0	3.0	3550/8270C
-BHC	U	U	µg/Kg	3.0	9.0	3550/8270C
-BHC	U	U	µg/Kg	3.0	9.0	3550/8270C
-BHC	U	U	µg/Kg	3.0	9.0	3550/8270C
-BHC (Lindane)	U	U	µg/Kg	1.0	3.0	3550/8270C
Clordane	U	U	µg/Kg	1.0	3.0	3550/8270C
4,4'-DDD	U	U	µg/Kg	2	6	3550/8270C
4,4'-DDE	U	U	µg/Kg	1.39	4017	3550/8270C
4,4'-DDT	U	U	µg/Kg	1.69	5.07	3550/8270C
Dieldrin	U	U	µg/Kg	0.840	2.520	3550/8270C
Endosulfan I	U	U	µg/Kg	1.100	3.300	3550/8270C
Endosulfan II	U	U	µg/Kg	1.60	4.80	3550/8270C
Endosulfan Sulfate	U	U	µg/Kg	1.70	5.10	3550/8270C
Endrin	U	U	µg/Kg	1.800	5.400	3550/8270C
Endrin Aldehyde	U	U	µg/Kg	1.900	5.700	3550/8270C
Heptachlor	U	U	µg/Kg	1.78	5.34	3550/8270C
Heptachlor Epoxide	U	U	µg/Kg	1.68	5.04	3550/8270C
Toxaphene	U	U	µg/Kg	1.90	5.70	3550/8270C

Table 15: GC/MS petroleum hydrocarbon speciation analysis of sediment core JP-7 (145-150 cm).

PARAMETER	RESULT	QC	UNITS	MDL	PQL	METHOD
PCB-1016	U	U	µg/Kg	0.30	0.90	3550/8270C
PCB-1221	U	U	µg/Kg	0.30	0.90	3550/8270C
PCB-1232	U	U	µg/Kg	0.30	0.90	3550/8270C
PCB-1242	U	U	µg/Kg	0.30	0.90	3550/8270C
PCB-1248	U	U	µg/Kg	0.30	0.90	3550/8270C
PCB-1254	U	U	µg/Kg	0.30	0.90	3550/8270C
PCB-1260	U	U	µg/Kg	0.30	0.90	3550/8270C
Dioxin	U	U	µg/Kg	30	90	3550/8270C
Azobenzene	U	U	µg/Kg	30	90	3550/8270C
Methoxychlor	U	U	µg/Kg	19	57	3550/8270C
Benzoic Acid	U	U	µg/Kg	30	90	3550/8270C
Aniline	U	U	µg/Kg	30	90	3550/8270C
4-Chloroaniline	U	U	µg/Kg	11	33	3550/8270C
Dibenzofuran	U	U	µg/Kg	30	90	3550/8270C
2-Nitroaniline	U	U	µg/Kg	37	111	3550/8270C
30Nitroaniline	U	U	µg/Kg	30	90	3550/8270C
4-Nitroaniline	U	U	µg/Kg	30	90	3550/8270C
Carbazole	U	U	µg/Kg	30	90	3550/8270C
2,6-Dichlorophenol	U	U	µg/Kg	17	51	3550/8270C
2,3,4,6-Tetrachlorophenol	U	U	µg/Kg	30	90	3550/8270C
2,3,5,6-Tetrachlorophenol	U	U	µg/Kg	30	90	3550/8270C
Pyridine	U	U	µg/Kg	67	201	3550/8270C
FL-PRO (Petroleum Residual Organic Totals) Soil Dilution Factor = 1						
TOTAL PRO (C8-C40)	25.4		mg/Kg	0.01	0.03	FL-PRO
TPHCWG TPH-CWG Speciation Method (Soils) Dilution Factor = 1						
C5-C7 Aromatics	U	U	µg/Kg	5.0	15.0	TPHCWG
C7-C8 Aromatics	U	U	µg/Kg	5.0	15.0	TPHCWG
C8-C10 Aromatics	U	U	µg/Kg	5.0	15.0	TPHCWG
C10-C12 Aromatics	U	U	µg/Kg	5.0	15.0	TPHCWG
C12-C16 Aromatics	U	U	µg/Kg	5.0	15.0	TPHCWG
C16-C21 Aromatics	75.6	U	µg/Kg	5.0	15.0	TPHCWG
C21-C35 Aromatics	U	U	µg/Kg	5.0	15.0	TPHCWG
C5-C6 Aliphatics	U	U	µg/Kg	5.0	15.0	TPHCWG
C6-C8 Aliphatics	U	U	µg/Kg	5.0	15.0	TPHCWG
C8-C10 Aliphatics	U	U	µg/Kg	5.0	15.0	TPHCWG
C10-C12 Aliphatics	U	U	µg/Kg	5.0	15.0	TPHCWG
C12-C16 Aliphatics	U	U	µg/Kg	5.0	15.0	TPHCWG
C16-C35 Aliphatics	25400	I	µg/Kg	5.0	15.0	TPHCWG

QC=Qualifier Code as defined by DEP 62-160; U=Undetected; MDL=Minimum Detection Limit; PQL=Practical Quantization Limit.

Table 16: GC/MS petroleum hydrocarbon speciation analysis of sediment core JP-9 (70-75 cm).						
PARAMETER	RESULT	QC	UNITS	MDL	PQL	METHOD
8260B VOA Compounds in Solids & Wastes GC/MS Dilution Factor = 1						
Methyl-tert-butyl-ether	2.74		µg/Kg	1.9	5.7	5030/8260B
Benzene	U	U	µg/Kg	0.85	2.55	5030/8260B
Toluene	U	U	µg/Kg	1.4	4.2	5030/8260B
Chlorobenzene	U	U	µg/Kg	2.3	6.9	5030/8260B
Ethylbenzene	U	U	µg/Kg	1.5	4.5	5030/8260B
M & p Xylene	U	U	µg/Kg	1.3	3.9	5030/8260B
o-Xylene	U	U	µg/Kg	1.1	3.3	5030/8260B
1,3-Dichlorobenzene	U	U	µg/Kg	3.2	9.6	5030/8260B
1,4-Dichlorobenzene	U	U	µg/Kg	2.0	6.0	5030/8260B
1,2-Dichlorobenzene	U	U	µg/Kg	3.5	10.5	5030/8260B
8270C Semivolatile Organics in Solids by GC/MS Dilution Factor = 1						
N-Nitrosodimethylamine	U	U	µg/Kg	69	207	3550/8270C
Phenol	U	U	µg/Kg	43	129	3550/8270C
2-Methyl Phenol (o-cresol)	U	U	µg/Kg	62	186	3550/8270C
3-Methyl Phenol (m-cresol)	U	U	µg/Kg	46	138	3550/8270C
4-Methyl Phenol (p-cresol)	U	U	µg/Kg	37	111	3550/8270C
Bis (2-Chloroethyl) Ether	U	U	µg/Kg	47	141	3550/8270C
2-Chlorophenol	U	U	µg/Kg	27.0	81.0	3550/8270C
1,3-Dichlorobenzene	U	U	µg/Kg	3.2	9.6	3550/8270C
1,4-Dichlorobenzene	U	U	µg/Kg	2.0	6.0	3550/8270C
Benzyl Alcohol	U	U	µg/Kg	3	9	3550/8270C
1,2-Dichlorobenzene	U	U	µg/Kg	3.5	10.5	3550/8270C
Bis (2-Chloroisopropyl) Ether	U	U	µg/Kg	47	141	3550/8270C
N-Nitrosodi-N-Proplamine	U	U	µg/Kg	24.0	72.0	3550/8270C
Hexachloroethane	U	U	µg/Kg	67	201	3550/8270C
Nitrobenzene	U	U	µg/Kg	38	114	3550/8270C
Isophorone	U	U	µg/Kg	76	228	3550/8270C
2-Nitrophenol	U	U	µg/Kg	78	234	3550/8270C
2,4-Dimethylphenol	U	U	µg/Kg	72	216	3550/8270C
Bis (2-Chloroethoxy)methane	U	U	µg/Kg	81	243	3550/8270C
2,4-Dichlorophenol	U	U	µg/Kg	59	177	3550/8270C
1,2,3-Trichlorobenzene	U	U	µg/Kg	32	96	3550/8270C
1,2,4-Trichlorobenzene	U	U	µg/Kg	42	126	3550/8270C
Napthalene	U	U	µg/Kg	1	3	3550/8270C
Hexachlorobutadiene	U	U	µg/Kg	14	42	3550/8270C
4-Chloro-3-Methylphenol	U	U	µg/Kg	66	198	3550/8270C
1-Methylnaphthalene	U	U	µg/Kg	1	3	3550/8270C
2-Methylnaphthlene	U	U	µg/Kg	1	3	3550/8270C
Hexachlorocyclopentadiene	U	U	µg/Kg	41	123	3550/8270C
2,3,6-Trichlorophenol	U	U	µg/Kg	98	294	3550/8270C
2,4,5-Trichlorophenol	U	U	µg/Kg	60	180	3550/8270C
2,4,6-Trichlorophenol	U	U	µg/Kg	53	159	3550/8270C
2-Chloronaphthalene	U	U	µg/Kg	34	102	3550/8270C
Dimethyl Phthalate	U	U	µg/Kg	38	114	3550/8270C
Acenaphthylene	U	U	µg/Kg	2.0	6.0	3550/8270C
2,6-Dinitrotoluene	U	U	µg/Kg	26	78	3550/8270C
Acenaphthene	U	U	µg/Kg	1.3	3.9	3550/8270C
2,4-Dinitrophenol	U	U	µg/Kg	34	102	3550/8270C
2,4-Dinitrotoluene	U	U	µg/Kg	41	123	3550/8270C

Table 16: GC/MS petroleum hydrocarbon speciation analysis of sediment core JP-9 (70-75 cm).						
PARAMETER	RESULT	QC	UNITS	MDL	PQL	METHOD
4-Nitrophenol	U	U	µg/Kg	37	111	3550/8270C
Diethyl Phthalate	U	U	µg/Kg	35	105	3550/8270C
Fluorene	U	U	µg/Kg	1.0	3.0	3550/8270C
4-Chlorophenyl Phenyl Ether	U	U	µg/Kg	45	135	3550/8270C
4,6-Dinitro-2-Methylphenol	U	U	µg/Kg	36	108	3550/8270C
N-Nitrosodiphenylamine	U	U	µg/Kg	51	153	3550/8270C
4-Bromophenyl Phenyl Ether	U	U	µg/Kg	38	114	3550/8270C
Hexachlorobenzene	U	U	µg/Kg	36	108	3550/8270C
Pentachlorophenol	U	U	µg/Kg	1.7	5.1	3550/8270C
Phenanthrene	U	U	µg/Kg	2	6	3550/8270C
Anthracene	U	U	µg/Kg	0.6	1.8	3550/8270C
Di-N-Butyl Phthalate	U	U	µg/Kg	34	102	3550/8270C
Fluoranthene	U	U	µg/Kg	1.6	4.8	3550/8270C
Benzidine	U	U	µg/Kg	33	99	3550/8270C
Pyrene	U	U	µg/Kg	2	6	3550/8270C
Butyl Benzyl Phthalate	U	U	µg/Kg	50	150	3550/8270C
Benzo(A)Anthracene	U	U	µg/Kg	1	3	3550/8270C
3,3-Dichlorobenzidine	U	U	µg/Kg	100	300	3550/8270C
Chrysene	U	U	µg/Kg	1	3	3550/8270C
Bis (2 Ethylhexyl) Phthalate	U	U	µg/Kg	39	117	3550/8270C
Di-N-Octyl Phthalate	U	U	µg/Kg	44	132	3550/8270C
Benzo(B)Fluoranthene	U	U	µg/Kg	1	3	3550/8270C
Benzo(K)Fluoranthene	U	U	µg/Kg	1	3	3550/8270C
Benzo(A)Pyrene	U	U	µg/Kg	1	3	3550/8270C
Indeno(1,2,3-CD)Pyrene	U	U	µg/Kg	2	6	3550/8270C
Dibenzo (A,H) Anthracene	U	U	µg/Kg	2	6	3550/8270C
Benzo(G,H,I)Perylene	U	U	µg/Kg	2	6	3550/8270C
Bis-2-ethylhexyl Adipate	U	U	µg/Kg	33	99	3550/8270C
Aldrin	U	U	µg/Kg	1.0	3.0	3550/8270C
-BHC	U	U	µg/Kg	3.0	9.0	3550/8270C
-BHC	U	U	µg/Kg	3.0	9.0	3550/8270C
-BHC	U	U	µg/Kg	3.0	9.0	3550/8270C
-BHC (Lindane)	U	U	µg/Kg	1.0	3.0	3550/8270C
Clordane	U	U	µg/Kg	1.0	3.0	3550/8270C
4,4'-DDD	U	U	µg/Kg	2	6	3550/8270C
4,4'-DDE	U	U	µg/Kg	1.39	4017	3550/8270C
4,4'-DDT	U	U	µg/Kg	1.69	5.07	3550/8270C
Dieldrin	U	U	µg/Kg	0.840	2.520	3550/8270C
Endosulfan I	U	U	µg/Kg	1.100	3.300	3550/8270C
Endosulfan II	U	U	µg/Kg	1.60	4.80	3550/8270C
Endosulfan Sulfate	U	U	µg/Kg	1.70	5.10	3550/8270C
Endrin	U	U	µg/Kg	1.800	5.400	3550/8270C
Endrin Aldehyde	U	U	µg/Kg	1.900	5.700	3550/8270C
Heptachlor	U	U	µg/Kg	1.78	5.34	3550/8270C
Heptachlor Epoxide	U	U	µg/Kg	1.68	5.04	3550/8270C
Toxaphene	U	U	µg/Kg	1.90	5.70	3550/8270C
PCB-1016	U	U	µg/Kg	0.30	0.90	3550/8270C
PCB-1221	U	U	µg/Kg	0.30	0.90	3550/8270C
PCB-1232	U	U	µg/Kg	0.30	0.90	3550/8270C
PCB-1242	U	U	µg/Kg	0.30	0.90	3550/8270C
PCB-1248	U	U	µg/Kg	0.30	0.90	3550/8270C

Table 16: GC/MS petroleum hydrocarbon speciation analysis of sediment core JP-9 (70-75 cm).						
PARAMETER	RESULT	QC	UNITS	MDL	PQL	METHOD
PCB-1254	U	U	µg/Kg	0.30	0.90	3550/8270C
PCB-1260	U	U	µg/Kg	0.30	0.90	3550/8270C
Dioxin	U	U	µg/Kg	30	90	3550/8270C
Azobenzene	U	U	µg/Kg	30	90	3550/8270C
Methoxychlor	U	U	µg/Kg	19	57	3550/8270C
Benzoic Acid	U	U	µg/Kg	30	90	3550/8270C
Aniline	U	U	µg/Kg	30	90	3550/8270C
4-Chloroaniline	U	U	µg/Kg	11	33	3550/8270C
Dibenzofuran	U	U	µg/Kg	30	90	3550/8270C
2-Nitroaniline	U	U	µg/Kg	37	111	3550/8270C
30Nitroaniline	U	U	µg/Kg	30	90	3550/8270C
4-Nitroaniline	U	U	µg/Kg	30	90	3550/8270C
Carbazole	U	U	µg/Kg	30	90	3550/8270C
2,6-Dichlorophenol	U	U	µg/Kg	17	51	3550/8270C
2,3,4,6-Tetrachlorophenol	U	U	µg/Kg	30	90	3550/8270C
2,3,5,6-Tetrachlorophenol	U	U	µg/Kg	30	90	3550/8270C
Pyridine	U	U	µg/Kg	67	201	3550/8270C
FL-PRO (Petroleum Residual Organic Totals) Soil Dilution Factor = 1						
TOTAL PRO (C8-C40)	12.5		mg/Kg	0.01	0.03	FL-PRO
TPHCWG TPH-CWG Speciation Method (Soils) Dilution Factor = 1						
C5-C7 Aromatics	U	U	µg/Kg	5.0	15.0	TPHCWG
C7-C8 Aromatics	U	U	µg/Kg	5.0	15.0	TPHCWG
C8-C10 Aromatics	U	U	µg/Kg	5.0	15.0	TPHCWG
C10-C12 Aromatics	U	U	µg/Kg	5.0	15.0	TPHCWG
C12-C16 Aromatics	U	U	µg/Kg	5.0	15.0	TPHCWG
C16-C21 Aromatics	U	U	µg/Kg	5.0	15.0	TPHCWG
C21-C35 Aromatics	U	U	µg/Kg	5.0	15.0	TPHCWG
C5-C6 Aliphatics	U	U	µg/Kg	5.0	15.0	TPHCWG
C6-C8 Aliphatics	U	U	µg/Kg	5.0	15.0	TPHCWG
C8-C10 Aliphatics	U	U	µg/Kg	5.0	15.0	TPHCWG
C10-C12 Aliphatics	U	U	µg/Kg	5.0	15.0	TPHCWG
C12-C16 Aliphatics	U	U	µg/Kg	5.0	15.0	TPHCWG
C16-C35 Aliphatics	12500	I	µg/Kg	5.0	15.0	TPHCWG

QC=Qualifier Code as defined by DEP 62-160; U=Undetected; MDL=Minimum Detection Limit; PQL=Practical Quantization Limit.

Table 17: Bouchard 155, tank 7 oil sample - GC/MS hydrocarbon analysis data.						
PARAMETER	RESULT	QC	UNITS	MDL	PQL	METHOD
Percent Solids	N/A		%	0.1	0.3	EPA 160.3
8260B VOA Compounds in Solids & Wastes GC/MS Dilution Factor = 5000						
Methyl-tert-butyl-ether	U	QU	µg/Kg	9500.0	28500.0	5030/8260B
Benzene	9550	QI	µg/Kg	4250.0	12750.0	5030/8260B
Toluene	47800	Q	µg/Kg	7000.0	21000.0	5030/8260B
Chlorobenzene	U	QU	µg/Kg	11500.0	34500.0	5030/8260B
Ethylbenzene	21900	QI	µg/Kg	7500.0	22500.0	5030/8260B
M & p Xylene	84600	Q	µg/Kg	6500.0	19500.0	5030/8260B
o-Xylene	30800	Q	µg/Kg	5500.0	16500.0	5030/8260B
1,3-Dichlorobenzene	U	QU	µg/Kg	16000.0	48000.0	5030/8260B
1,4-Dichlorobenzene	U	QU	µg/Kg	10000.0	30000.0	5030/8260B
1,2-Dichlorobenzene	U	QU	µg/Kg	17500.0	52500.0	5030/8260B
8270C Semivolatile Organics in Solids by GC/MS Dilution Factor = 10000						
Napthalene	6100000	Q	µg/Kg	10700.0	32100.0	3550/8270C
1-Methylnaphthalene	4950000	Q	µg/Kg	8400.0	25200.0	3550/8270C
2-Methylnaphthlene	7300000	Q	µg/Kg	10500.0	31500.0	3550/8270C
Acenaphthene	970000	Q	µg/Kg	12500.0	37500.0	3550/8270C
Acenaphthylene	U	QU	µg/Kg	10100.0	30300.0	3550/8270C
Fluorene	600000	Q	µg/Kg	9900.0	29700.0	3550/8270C
Phenanthrene	1700000	Q	µg/Kg	19600.0	48300.0	3550/8270C
Anthracene	290000	Q	µg/Kg	6100.0	18300.0	3550/8270C
Fluoranthene	270000	Q	µg/Kg	16100.0	48300.0	3550/8270C
Pyrene	1100000	Q	µg/Kg	19700.0	59100.0	3550/8270C
Benzo(A)Anthracene	1300000	Q	µg/Kg	12500.0	37500.0	3550/8270C
Chrysene	2400000	Q	µg/Kg	12500.0	37500.0	3550/8270C
Benzo(B)Fluoranthene	625000	Q	µg/Kg	10100.0	30300.0	3550/8270C
Benzo(K)Fluoranthene	U	QU	µg/Kg	7000.0	21000.0	3550/8270C
Benzo(A)Pyrene	660000	Q	µg/Kg	8300.0	24900.0	3550/8270C
Indeno(1,2,3-CD)Pyrene	U	QU	µg/Kg	17400.0	52200.0	3550/8270C
Dibenzo (A,H) Anthracene	U	QU	µg/Kg	10900.0	32700.0	3550/8270C
Benzo(G,H,I)Perylene	U	QU	µg/Kg	15700.0	47100.0	3550/8270C
FL-PRO (Petroleum Residual Organic Totals) Soil Dilution Factor = 1						
TOTAL PRO (C8-C40)	206000	Q	mg/Kg	0.01	0.03	FL-PRO
TPHCWG TPH-CWG Speciation Method (Soils) Dilution Factor = 1						
C5-C7 Aromatics	U	QU	µg/Kg	5.0	15.0	TPHCWG
C7-C8 Aromatics	83000	Q	µg/Kg	5.0	15.0	TPHCWG
C8-C10 Aromatics	U	QU	µg/Kg	5.0	15.0	TPHCWG
C10-C12 Aromatics	U	QU	µg/Kg	5.0	15.0	TPHCWG
C12-C16 Aromatics	19920000	Q	µg/Kg	5.0	15.0	TPHCWG
C16-C21 Aromatics	8350000	Q	µg/Kg	5.0	15.0	TPHCWG
C21-C35 Aromatics	U	QU	µg/Kg	5.0	15.0	TPHCWG
C5-C6 Aliphatics	U	QU	µg/Kg	5.0	15.0	TPHCWG
C6-C8 Aliphatics	U	QU	µg/Kg	5.0	15.0	TPHCWG
C8-C10 Aliphatics	1930000	Q	µg/Kg	5.0	15.0	TPHCWG
C10-C12 Aliphatics	4300000	Q	µg/Kg	5.0	15.0	TPHCWG
C12-C16 Aliphatics	21200000	Q	µg/Kg	5.0	15.0	TPHCWG
C16-C35 Aliphatics	160000000	Q	µg/Kg	5.0	15.0	TPHCWG

QC=Qualifier Code as defined by DEP 62-160; U=Undetected; I=In between the MDL and PQL; Q= Out of hold; MDL=Minimum Detection Limit; PQL=Practical Quantation Limit.

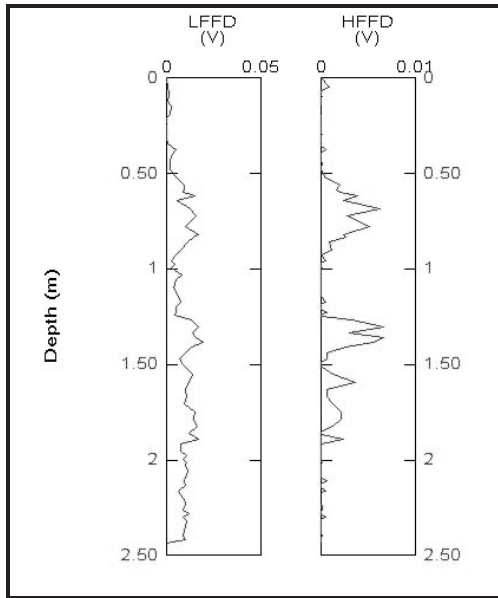

Figure 17: FFD probe analysis of JP-1.

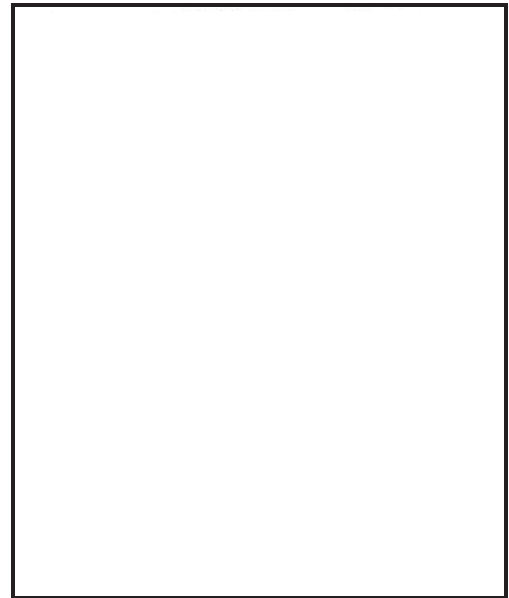

Figure 18: FFD probe analysis of JP-3.

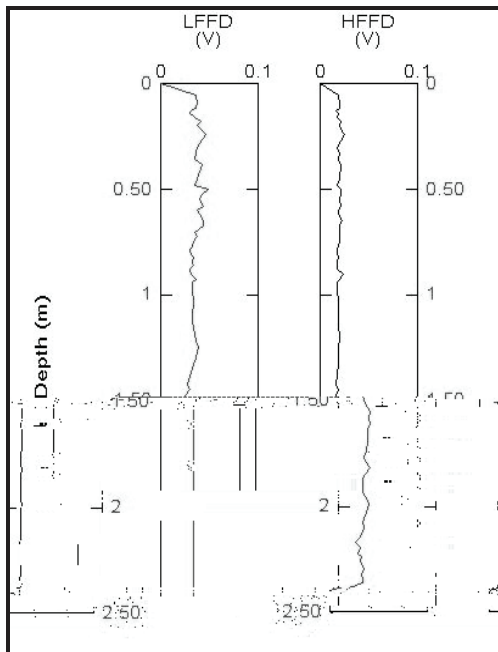

Figure 19: FFD probe analysis of JP-4.

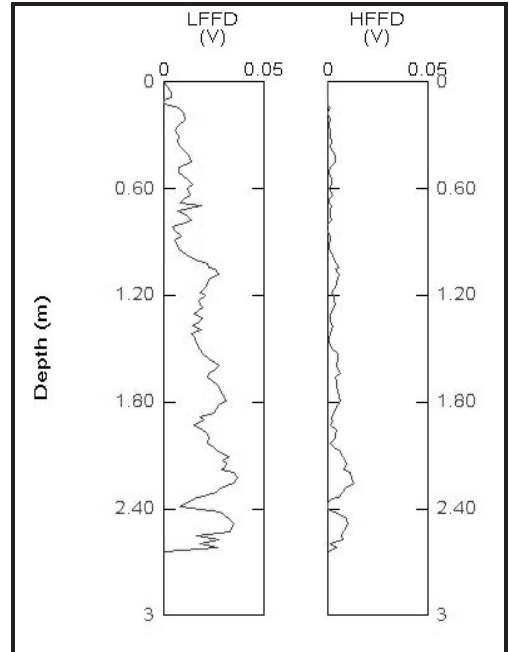

Figure 20: FFD probe analysis of JP-5.

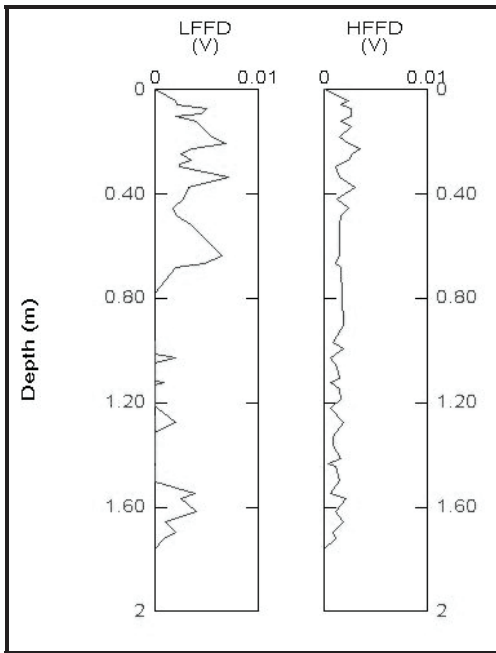

Figure 21: FFD probe analysis of JP-6.

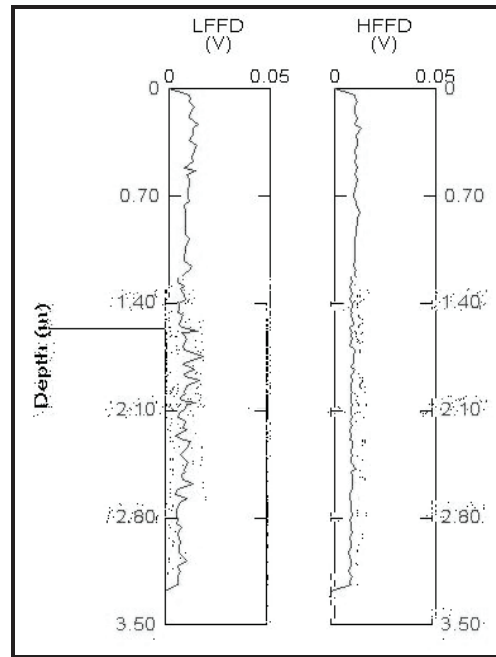

Figure 22: FFD probe analysis of JP-7.

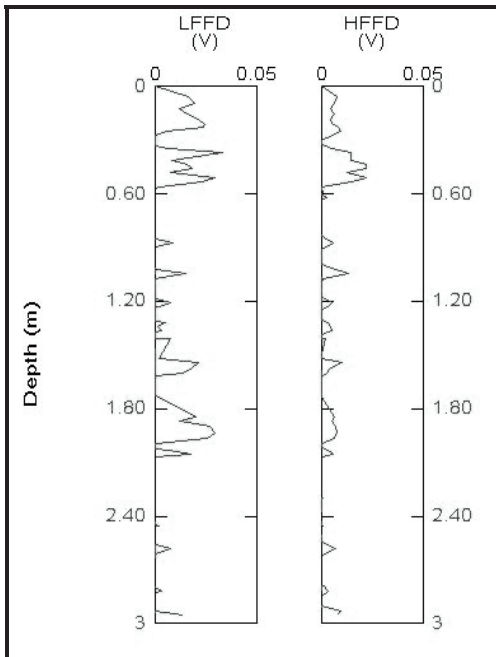

Figure 23: FFD probe analysis of JP-8.

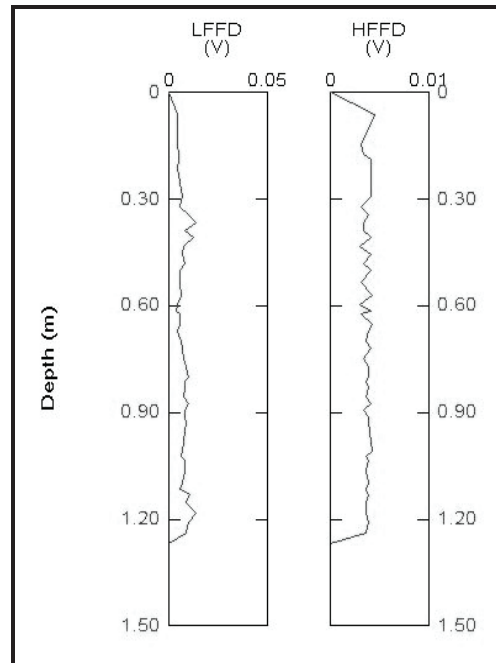

Figure 24: FFD probe analysis of JP-9.

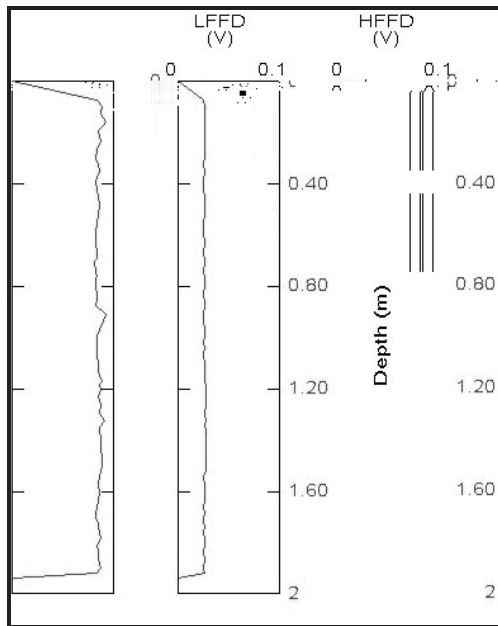

Figure 25: FFD probe analysis of JP-10.

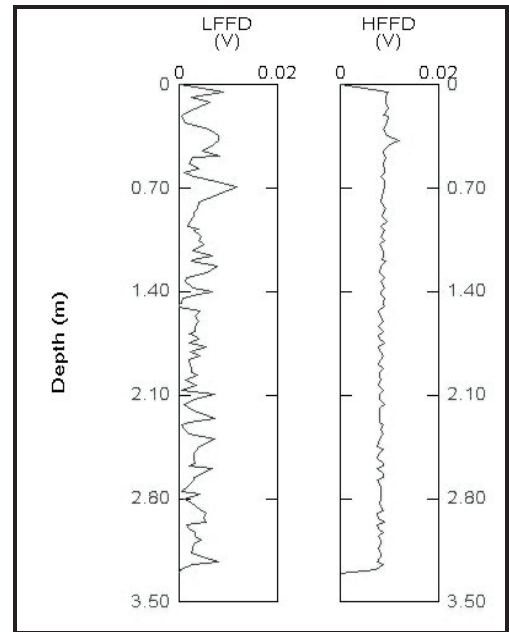

Figure 26: FFD probe analysis of JP-11(2).

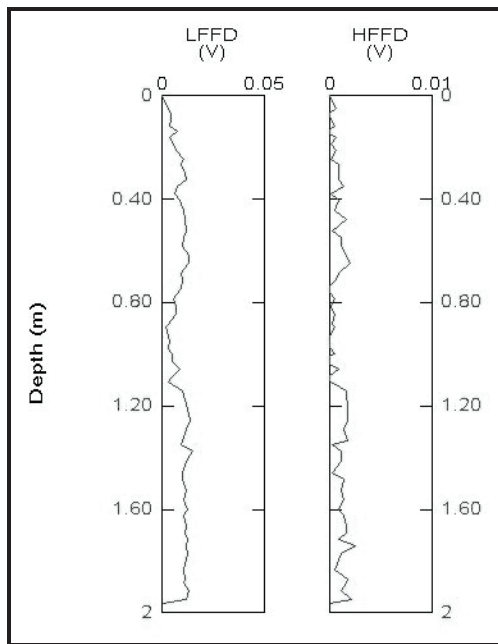

Figure 27: FFD probe analysis of JP-12(2).

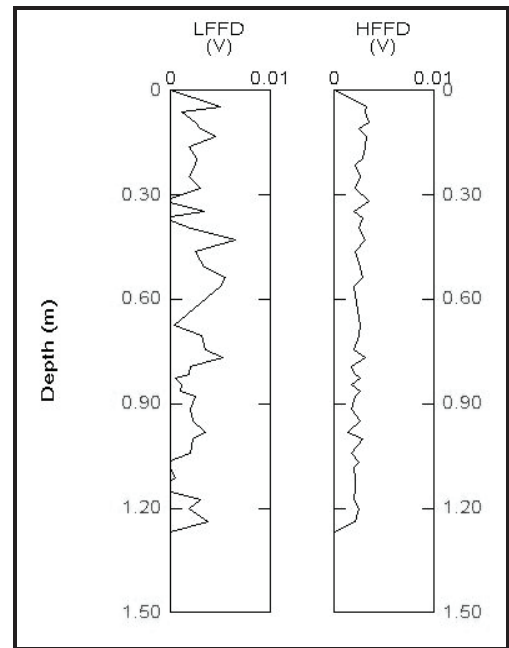

Figure 28: FFD probe analysis of JP-13.

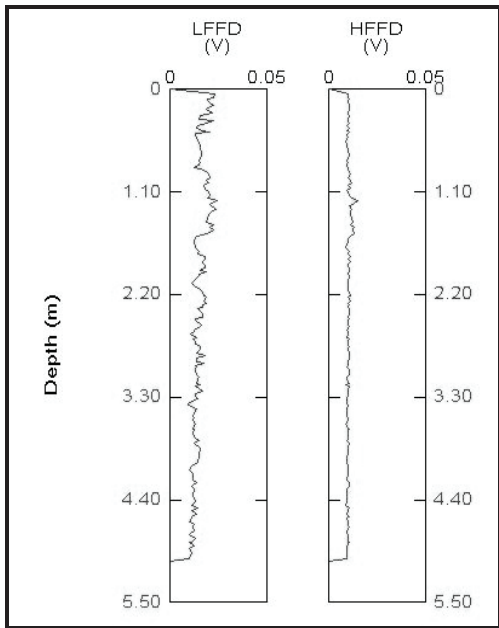

Figure 29: FFD probe analysis of JP-14.

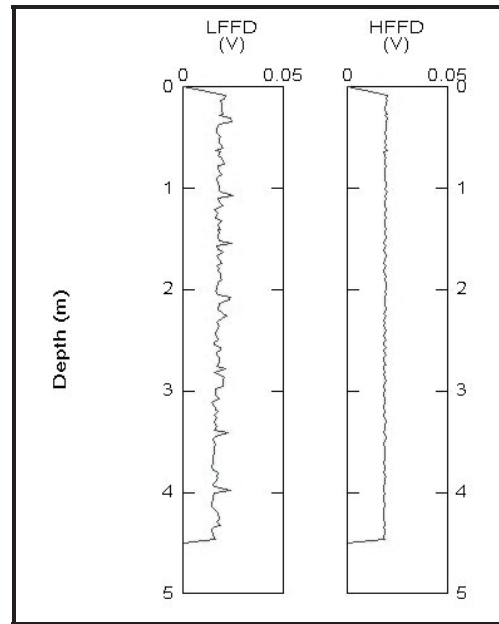

Figure 30: FFD probe analysis of JP-15.